



US00D832967S

(12) **United States Design Patent** (10) **Patent No.:** **US D832,967 S**
Martin (45) **Date of Patent:** **** Nov. 6, 2018**

(54) **PLAYGROUND CLIMBER STRUCTURE**

(74) *Attorney, Agent, or Firm* — Abelman, Frayne & Schwab

(71) Applicant: **Richard Martin**, Ontario (CA)

(72) Inventor: **Richard Martin**, Ontario (CA)

(**) Term: **15 Years**

(57) **CLAIM**

(21) Appl. No.: **29/600,137**

The ornamental design for a playground climber structure, as shown and described.

(22) Filed: **Apr. 10, 2017**

(30) **Foreign Application Priority Data**

DESCRIPTION

Jan. 25, 2017 (CA) 172753

(51) **LOC (11) Cl.** **21-02**

(52) **U.S. Cl.**
USPC **D21/826**

(58) **Field of Classification Search**
USPC D21/811, 814, 826–827
CPC A63B 9/00; A63B 69/0048; A63B 17/00;
A63B 17/02
See application file for complete search history.

FIG. 1 is a perspective view of a playground climber structure, according to the present invention;
FIG. 2 is a right side view thereof;
FIG. 3 is a left side view thereof;
FIG. 4 is a rear view thereof;
FIG. 5 is a front view thereof;
FIG. 6 is a top view thereof;
FIG. 7 is a bottom view thereof;
FIG. 8 is a perspective view thereof, showing unclaimed handhold and foothold features;
FIG. 9 is a perspective view thereof, showing unclaimed mounting holes;
FIG. 10 is a perspective view of a second embodiment of a playground climber structure, according to another embodiment of the present invention;
FIG. 11 is a right side view of FIG. 10;
FIG. 12 is a left side view of FIG. 10;
FIG. 13 is a rear view of FIG. 10;
FIG. 14 is a front view of FIG. 10;
FIG. 15 is a top view of FIG. 10;
FIG. 16 is a bottom view of FIG. 10;
FIG. 17 is a perspective view of FIG. 10, showing unclaimed handhold and foothold features; and,
FIG. 18 is a perspective view of FIG. 10, showing unclaimed mounting holes.
The broken lines showing of the mounting holes, handholds, and footholds for illustrative purposes only and forms no part of the claimed design.

(56) **References Cited**

U.S. PATENT DOCUMENTS

- 5,125,877 A * 6/1992 Brewer A63B 69/0048
482/37
- 6,083,142 A * 7/2000 Wilson A63B 69/0048
280/DIG. 8
- 6,551,216 B2 * 4/2003 Rennex A63B 7/04
482/35
- D493,504 S * 7/2004 Byrd D21/827
- D495,392 S * 8/2004 Byrd D21/827
- D496,088 S * 9/2004 Byrd D21/827
- D496,423 S * 9/2004 Byrd D21/827
- 6,849,031 B2 * 2/2005 Paci A63B 69/0048
482/35
- D518,137 S * 3/2006 Byrd D21/827
- D521,099 S * 5/2006 Byrd D21/827
- 7,056,266 B2 * 6/2006 Sudeith A63B 69/0048
482/37
- D536,407 S * 2/2007 Nye D21/818

(Continued)

Primary Examiner — Mitchell I. Siegel

1 Claim, 12 Drawing Sheets



(56)

References Cited

U.S. PATENT DOCUMENTS

D536,410	S	*	2/2007	Nye	D21/822
D538,878	S	*	3/2007	Kearl	D21/827
D554,227	S	*	10/2007	Yates	D21/826
7,563,202	B1	*	7/2009	Sudeith	A63B 69/0048 482/37
D616,519	S	*	5/2010	Hwang	D21/826
8,038,581	B1	*	10/2011	Sudeith	A63B 69/0048 482/37
D673,236	S	*	12/2012	Roberts	D21/827
D761,371	S	*	7/2016	Feiereisen	D21/826
2007/0082791	A1	*	4/2007	Reese	A63B 9/00 482/37

* cited by examiner

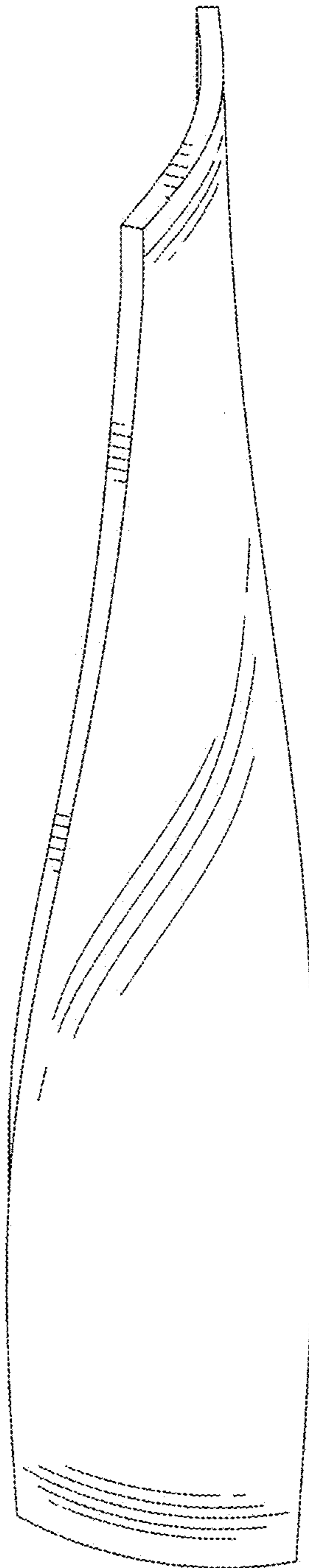

FIG. 1

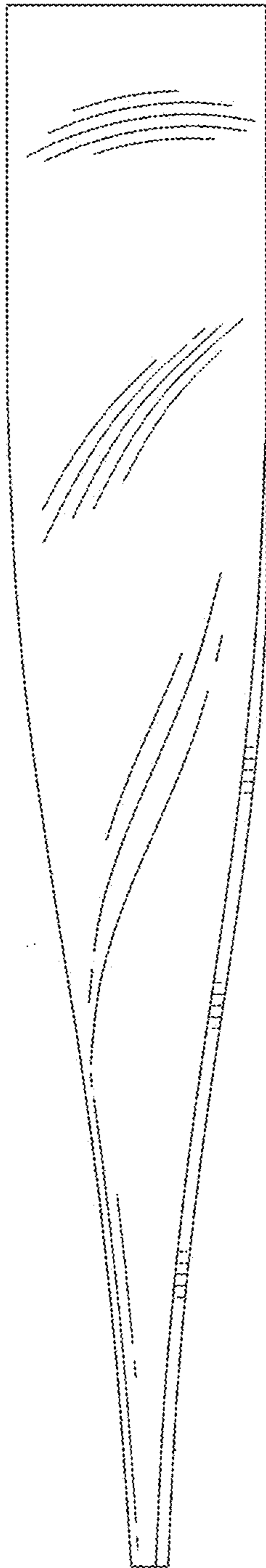

FIG. 2

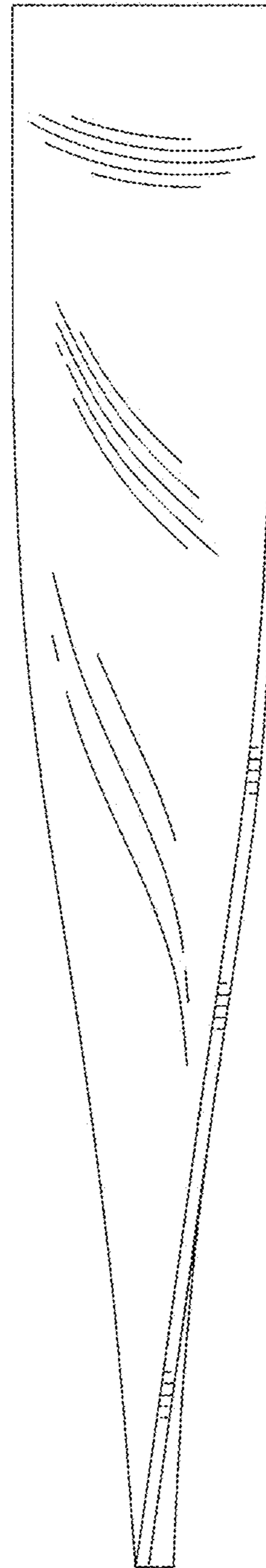

FIG. 3

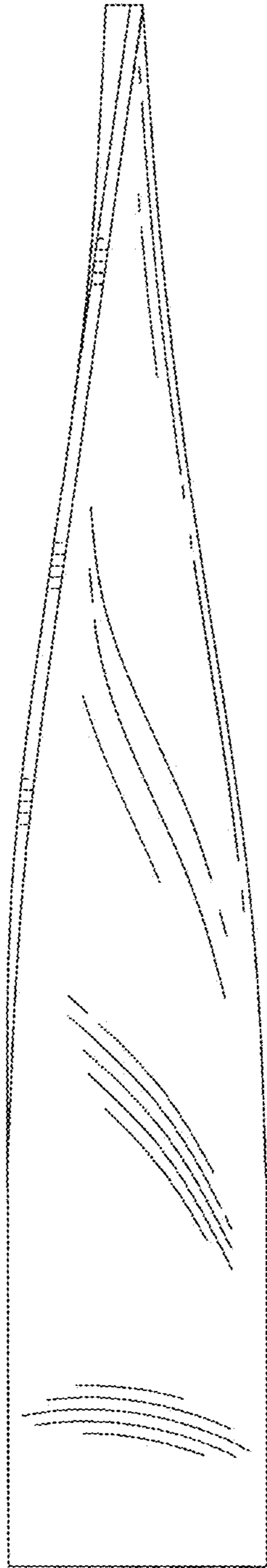

FIG. 4

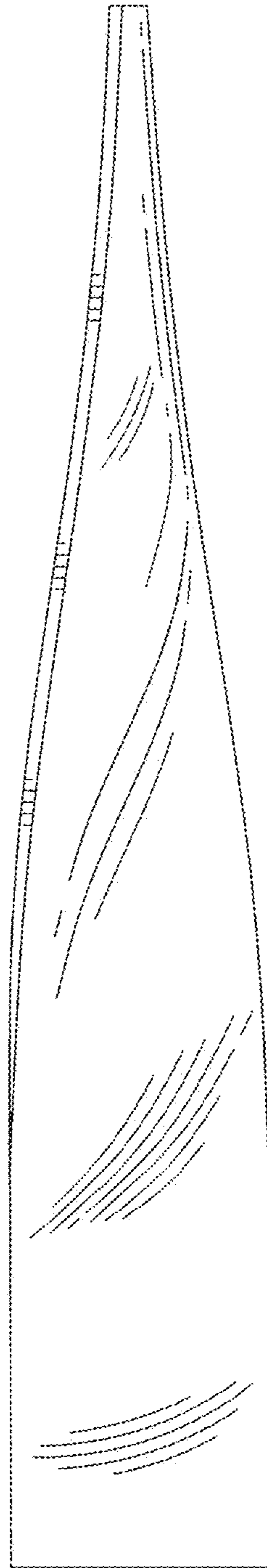

FIG. 5

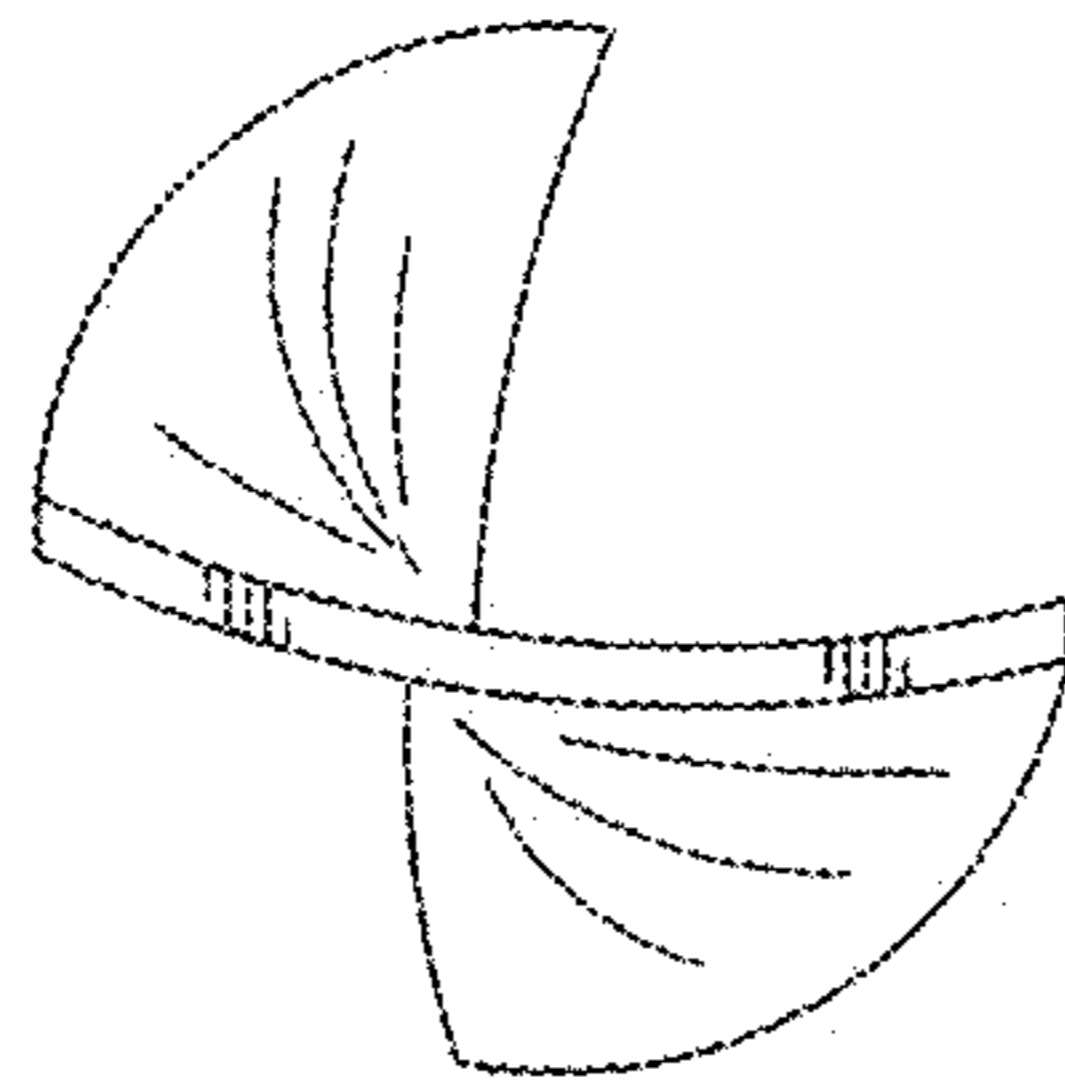

FIG. 6

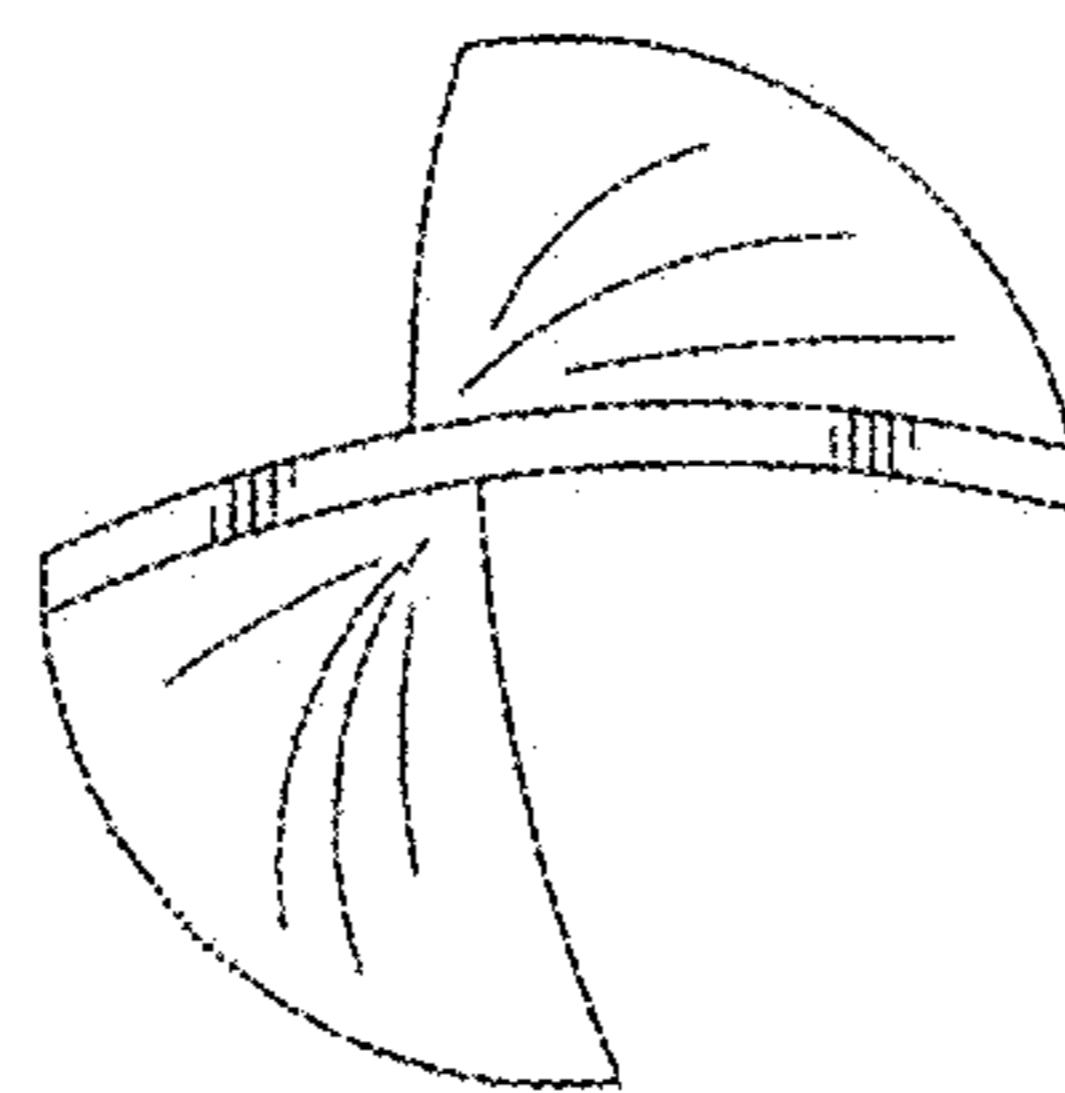

FIG. 7

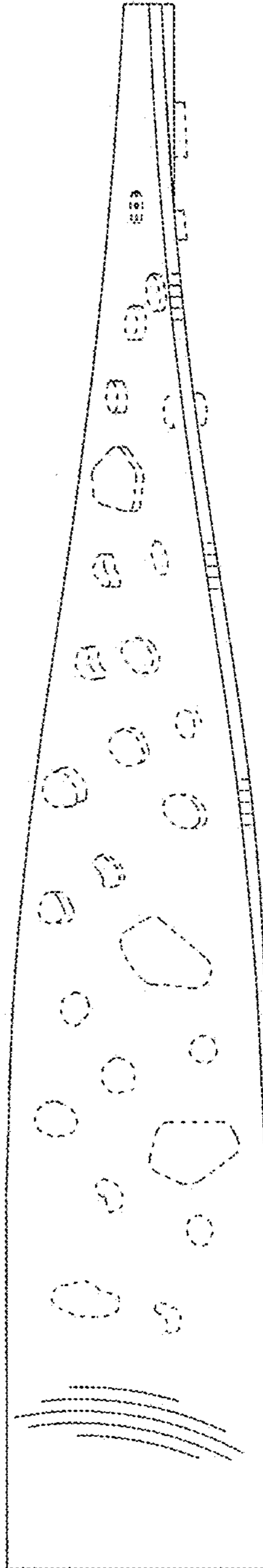

FIG. 8

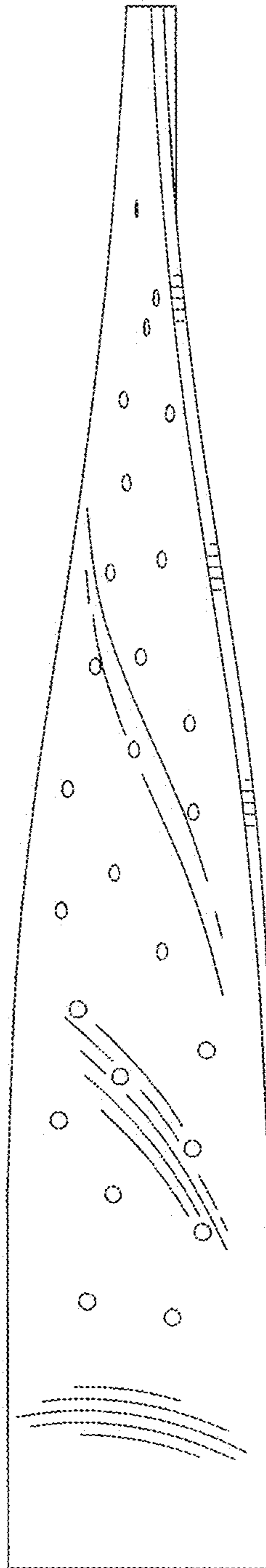

FIG. 9

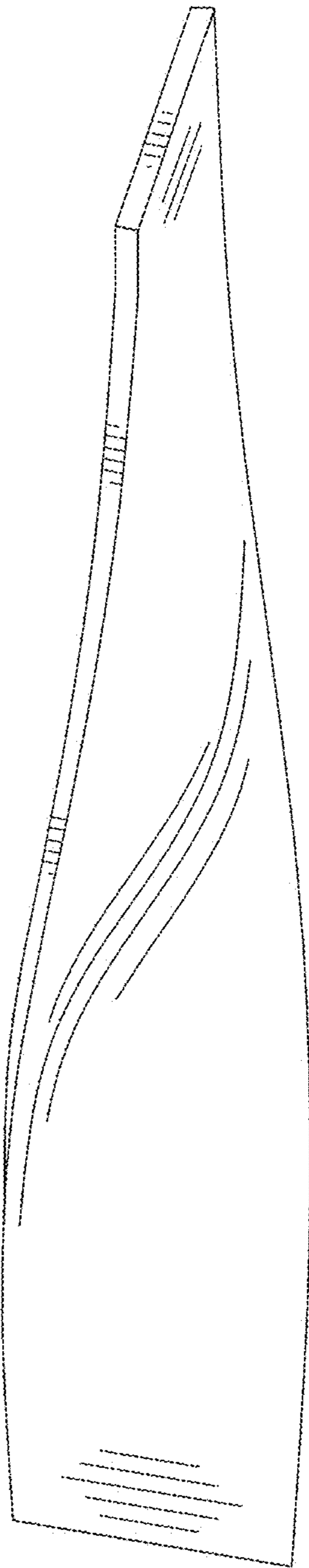

FIG. 10

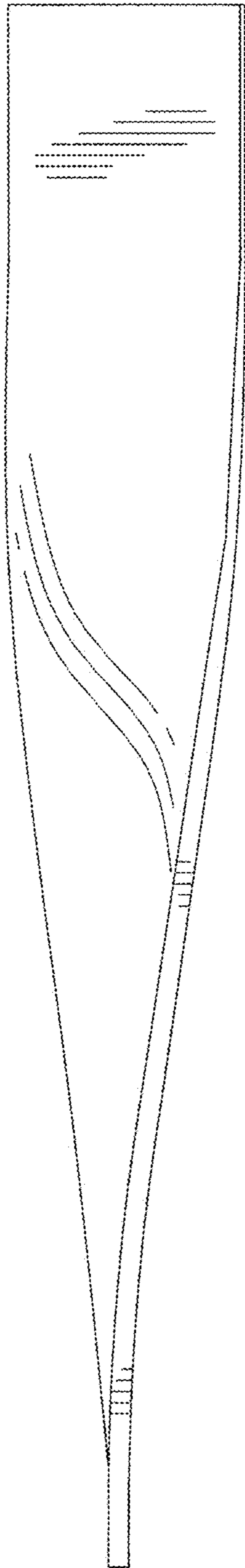

FIG. 11

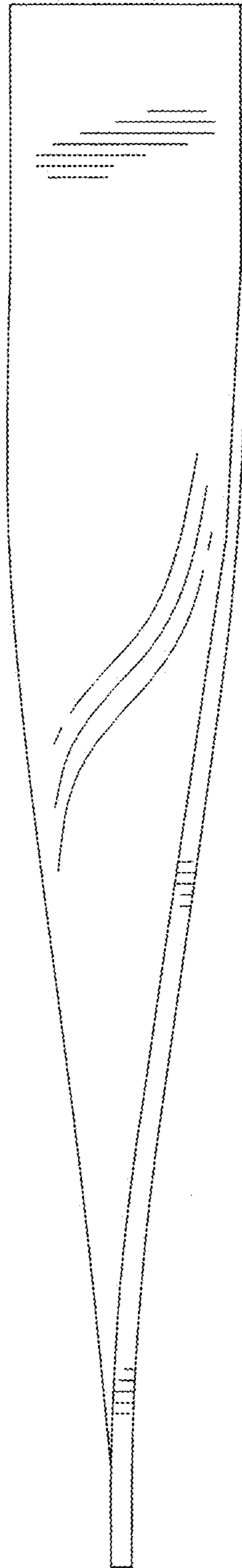

FIG. 12

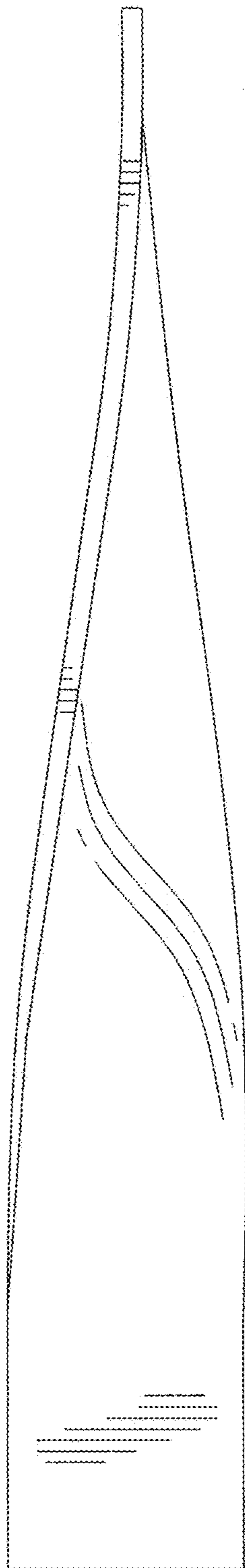

FIG. 13

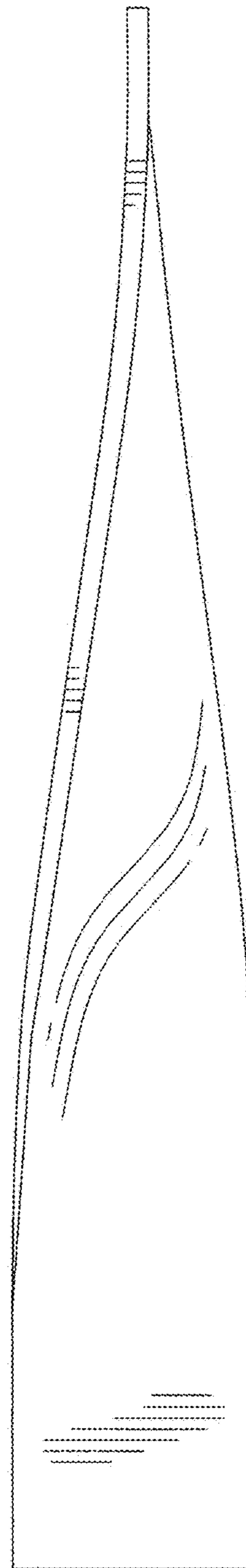

FIG. 14

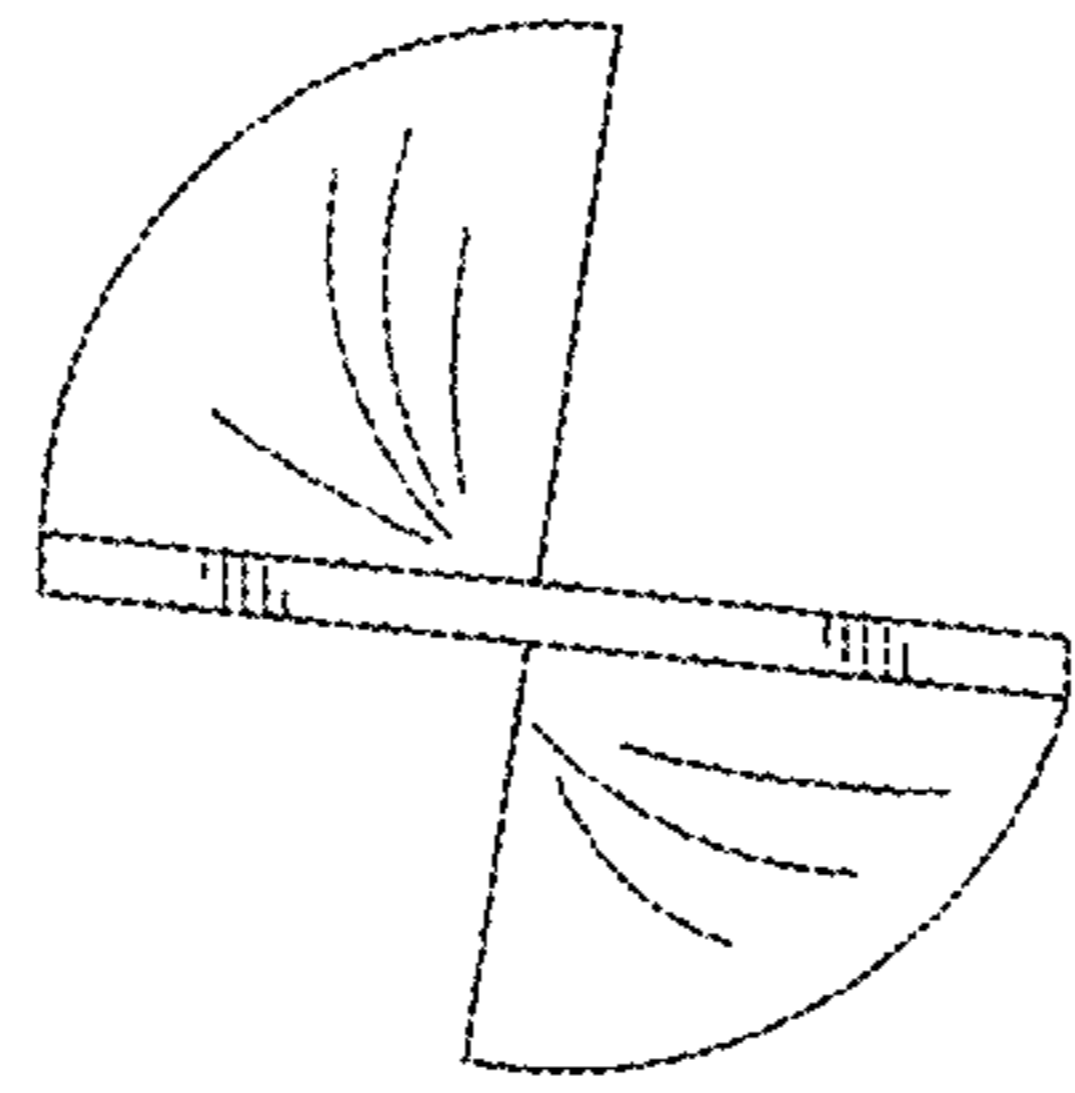

FIG. 15

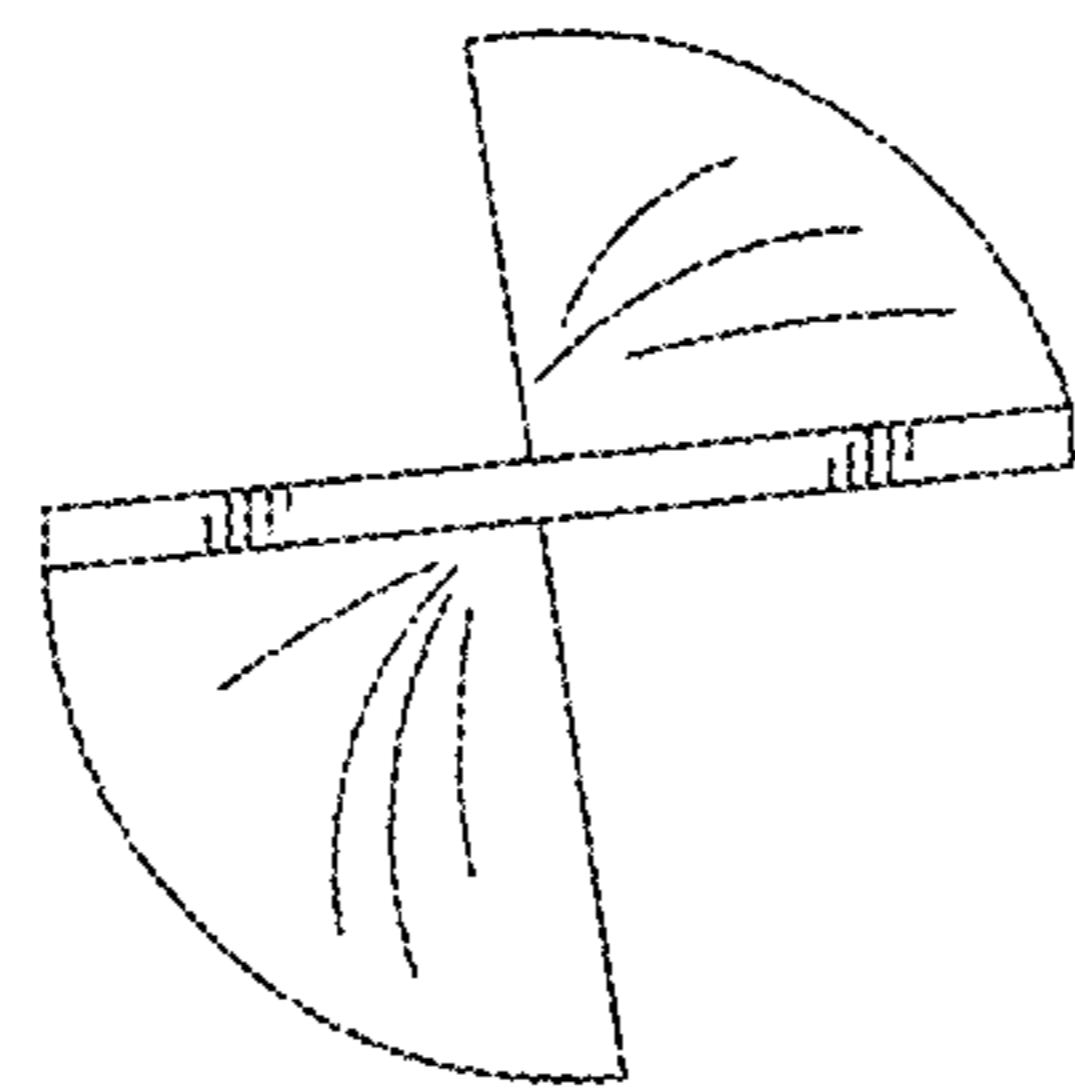

FIG. 16

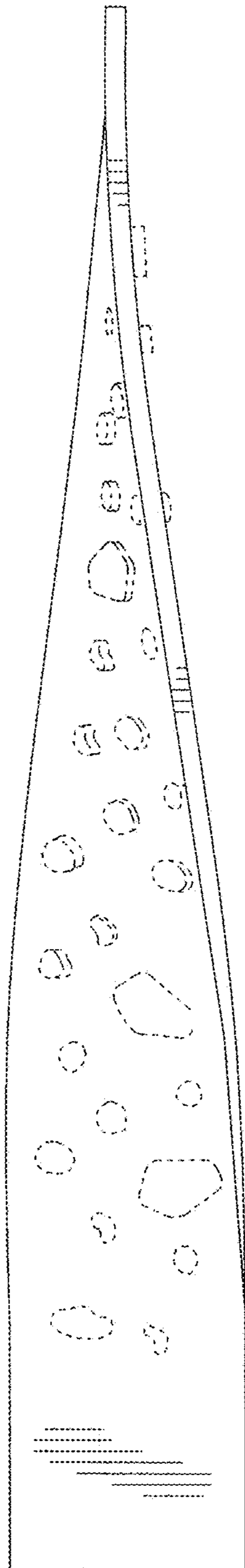

FIG. 17

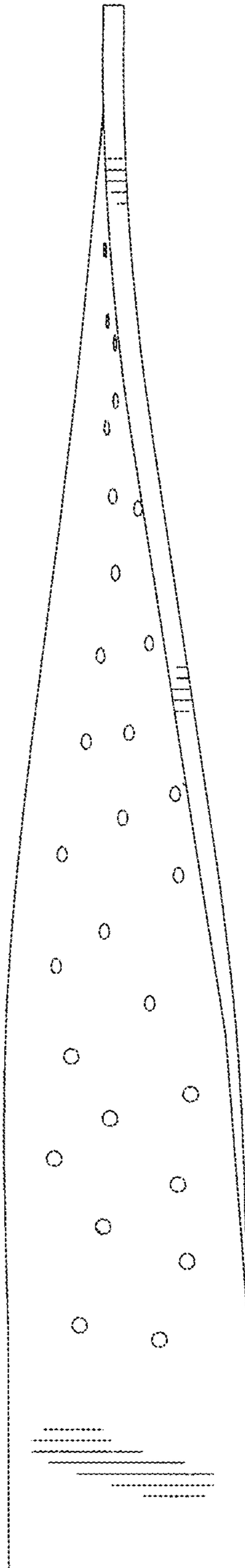

FIG. 18