



US00D832856S

(12) **United States Design Patent**
Jinkinson et al.

(10) **Patent No.:** **US D832,856 S**

(45) **Date of Patent:** **** Nov. 6, 2018**

(54) **PROTECTIVE COVER**

(71) Applicant: **Logitech Europe S.A.**, Lausanne (CH)

(72) Inventors: **Nicholas Jinkinson**, St-Sulpice (CH);
Meng-Yu Tsai, New Taipei (TW)

(73) Assignee: **Logitech Europe S.A.**, Lausanne (CH)

(**) Term: **15 Years**

(21) Appl. No.: **29/624,401**

(22) Filed: **Oct. 31, 2017**

Related U.S. Application Data

(63) Continuation-in-part of application No. 29/615,722,
filed on Aug. 30, 2017.

(51) **LOC (11) Cl.** **14-02**

(52) **U.S. Cl.**
USPC **D14/440**

(58) **Field of Classification Search**

USPC D14/440; 206/45.23, 320, 45.2;
361/679.55; 294/25; 224/218

CPC ... G06F 1/1628; G06F 1/1626; A47B 23/044;
H04B 1/3888; H05K 5/0217

See application file for complete search history.

(56) **References Cited**

U.S. PATENT DOCUMENTS

D696,256 S *	12/2013	Piedra	D14/440
D696,669 S *	12/2013	Akana	D14/440
D700,611 S *	3/2014	Boldetti	D14/440
D729,253 S *	5/2015	Nyholm	D14/440
D733,152 S *	6/2015	Sirichai	D14/440
9,095,194 B2 *	8/2015	Hassett	A45C 11/00
D744,489 S *	12/2015	Sirichai	D14/440
D764,472 S *	8/2016	Corcoran	D14/440
D772,880 S *	11/2016	Corcoran	D14/440
D789,342 S *	6/2017	Sirichai	D14/250
D792,887 S *	7/2017	Zhang	D14/440

D807,363 S *	1/2018	Hallier	D14/440
D807,365 S *	1/2018	Liu	D14/440
D807,892 S *	1/2018	Wang	D14/440

(Continued)

Primary Examiner — Cynthia R Underwood

(74) *Attorney, Agent, or Firm* — Kilpatrick Townsend &
Stockton LLP

(57) **CLAIM**

The ornamental design for protective cover, as shown and
described.

DESCRIPTION

FIG. 1 is a perspective view of a protective cover showing our new design in an open configuration;
 FIG. 2 is a second perspective view thereof;
 FIG. 3 is a top plan view thereof;
 FIG. 4 is a bottom plan view thereof;
 FIG. 5 is a front elevation view thereof;
 FIG. 6 is a rear elevation view thereof;
 FIG. 7 is a left side elevation view thereof; and
 FIG. 8 is a right side elevation view thereof.
 FIG. 9 is a perspective view of the protective cover showing our new design in a closed configuration;
 FIG. 10 is a second perspective view thereof;
 FIG. 11 is a top plan view thereof;
 FIG. 12 is a bottom plan view thereof;
 FIG. 13 is a front elevation view thereof;
 FIG. 14 is a rear elevation view thereof;
 FIG. 15 is a left side elevation view thereof; and
 FIG. 16 is a right side elevation view thereof.
 FIG. 17 is a perspective view of the protective cover showing our new design in an upright configuration;
 FIG. 18 is a bottom plan view thereof;
 FIG. 19 is a rear elevation view thereof;
 FIG. 20 is a left side elevation view thereof; and,
 FIG. 21 is a right side elevation view thereof.
 Broken lines shown in the drawings show unclaimed subject matter and form no part of the claimed design.

1 Claim, 11 Drawing Sheets

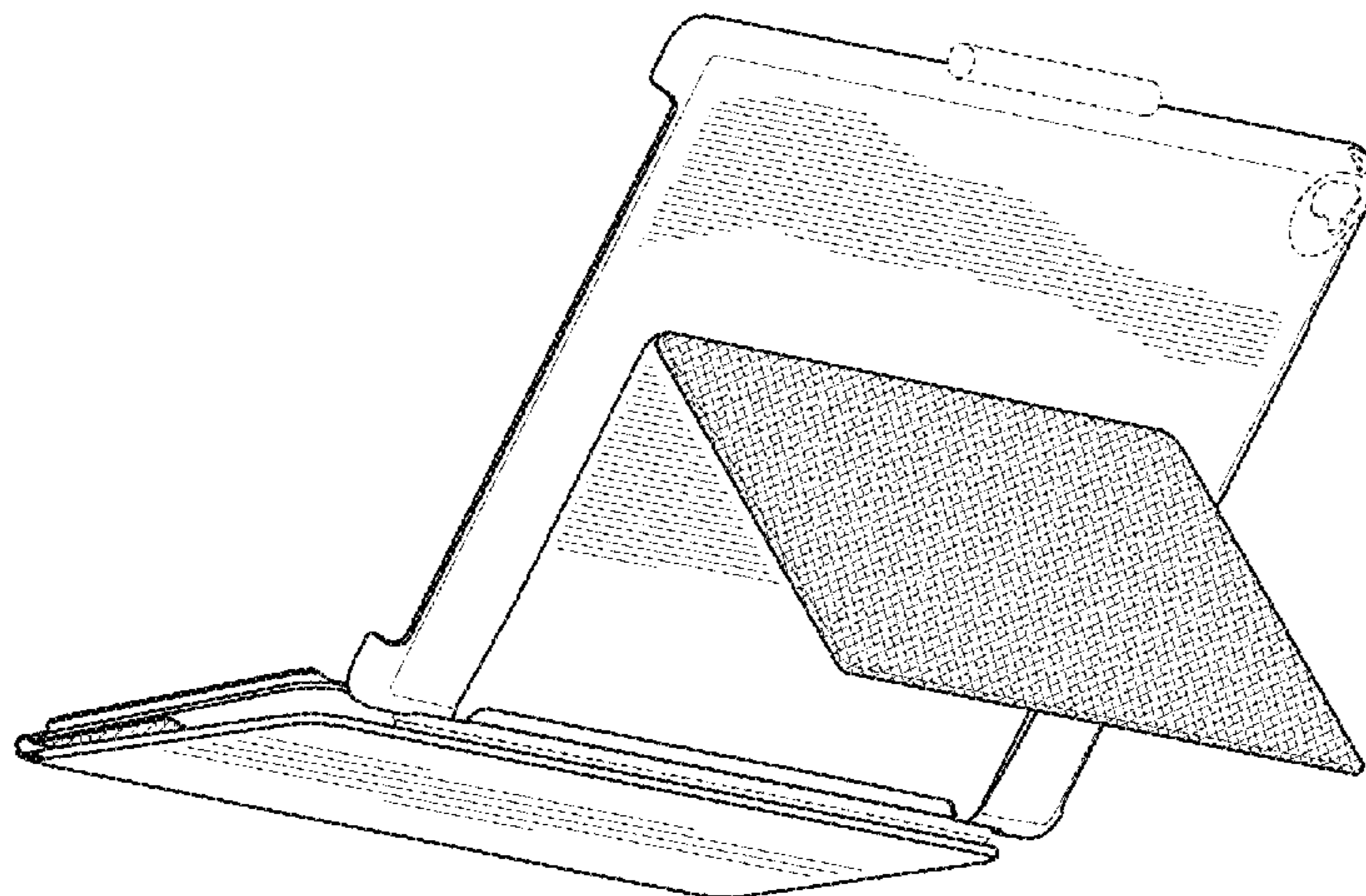

(56)

References Cited

U.S. PATENT DOCUMENTS

D808,394 S * 1/2018 Lakraa et al. D14/440
D808,395 S * 1/2018 Fenton D14/440
D811,411 S * 2/2018 Moore D14/440
D822,675 S * 7/2018 Zhu D14/455
2009/0194209 A1* 8/2009 De Filippis A45C 11/00
150/107
2009/0201254 A1* 8/2009 Rais G06F 1/1613
345/168
2010/0300909 A1* 12/2010 Hung H04M 1/04
206/320
2013/0264459 A1* 10/2013 McCosh G06F 1/1626
248/688
2015/0296060 A1* 10/2015 Gu H04M 1/0235
455/575.4
2015/0296068 A1* 10/2015 Chin G06F 1/1628
455/575.8
2016/0011628 A1* 1/2016 Sato G06F 1/1656
361/679.3
2016/0187937 A1* 6/2016 Ahee G06F 1/1681
361/679.09

* cited by examiner

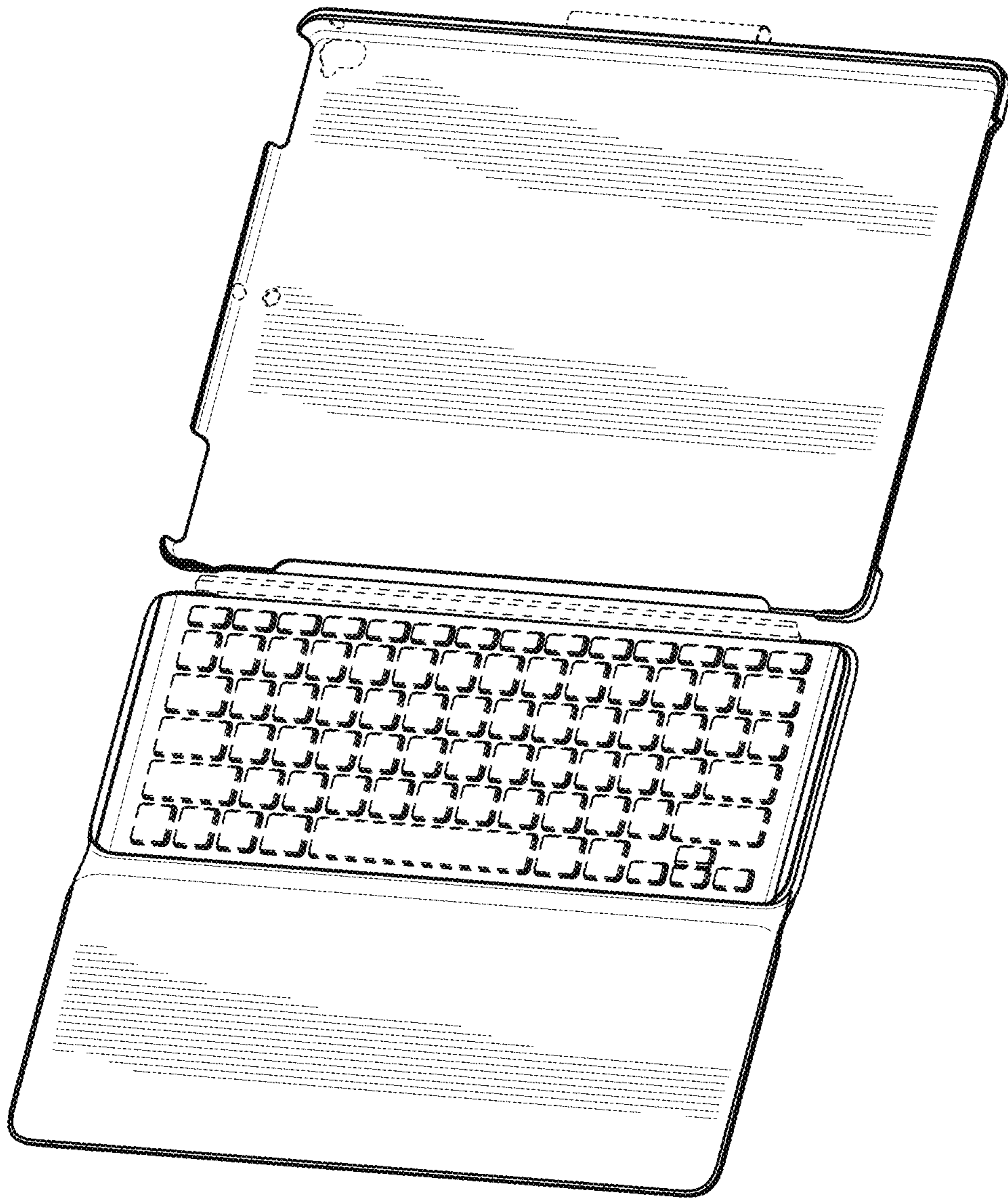

FIG. 1

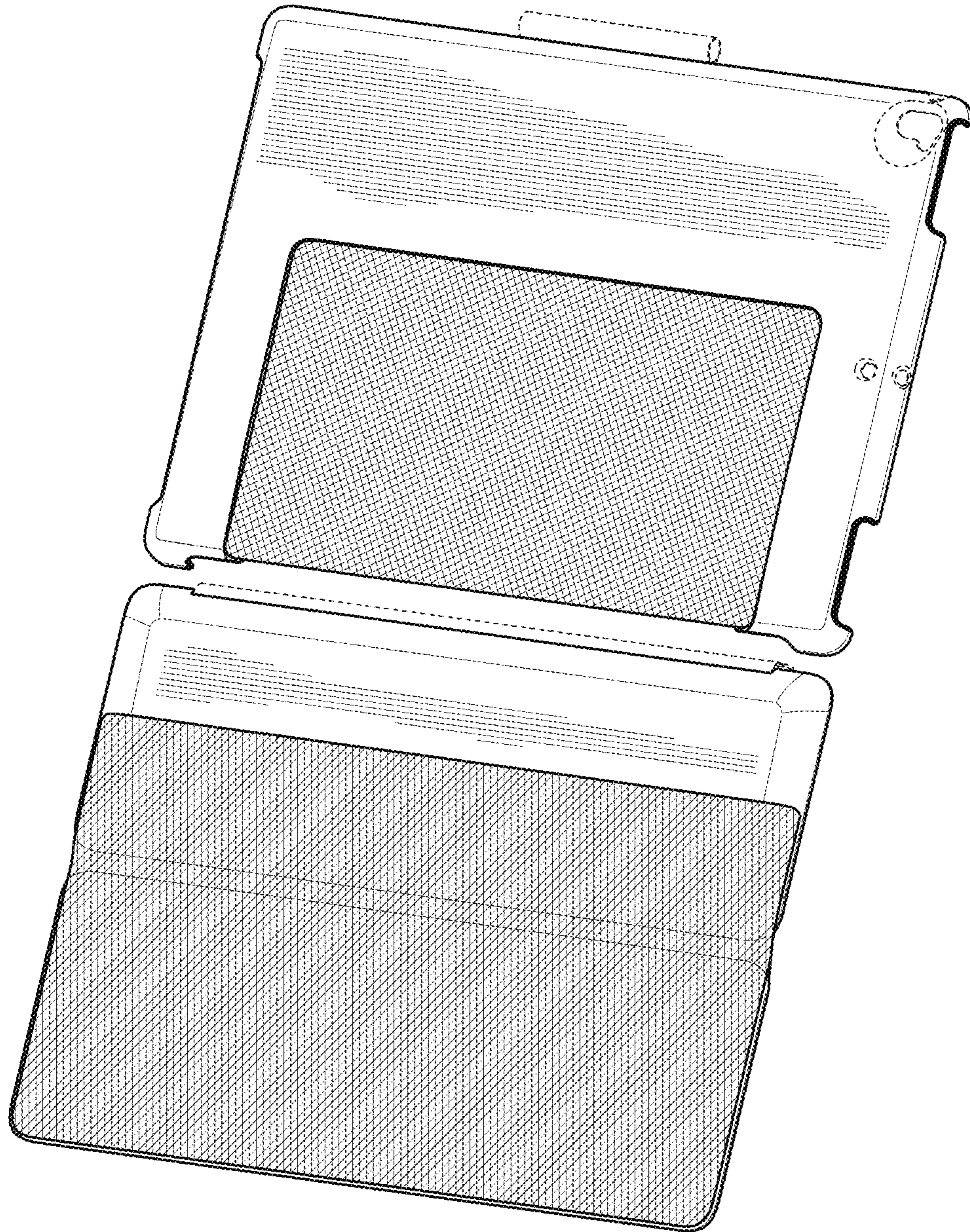

FIG. 2

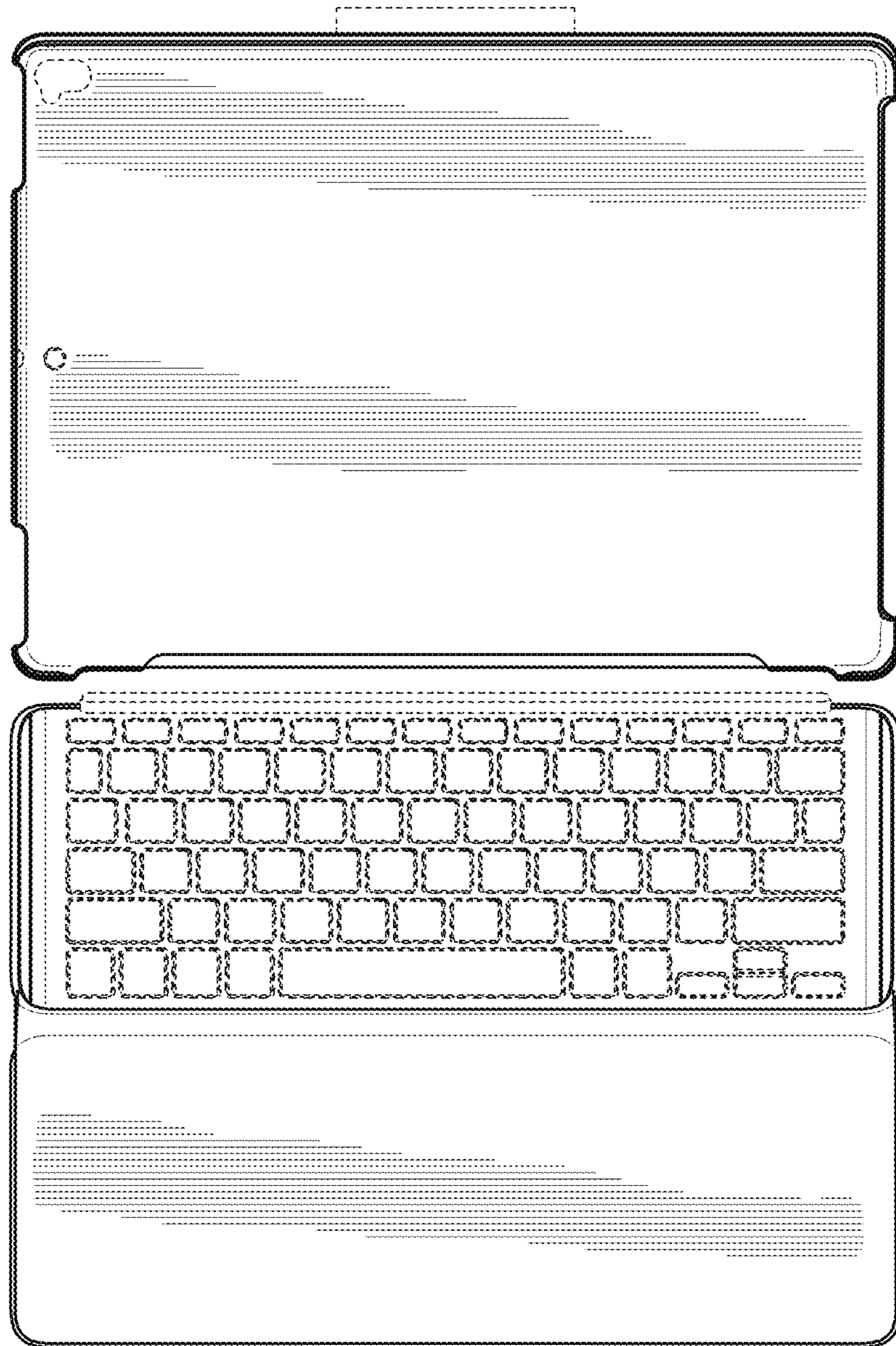

FIG. 3

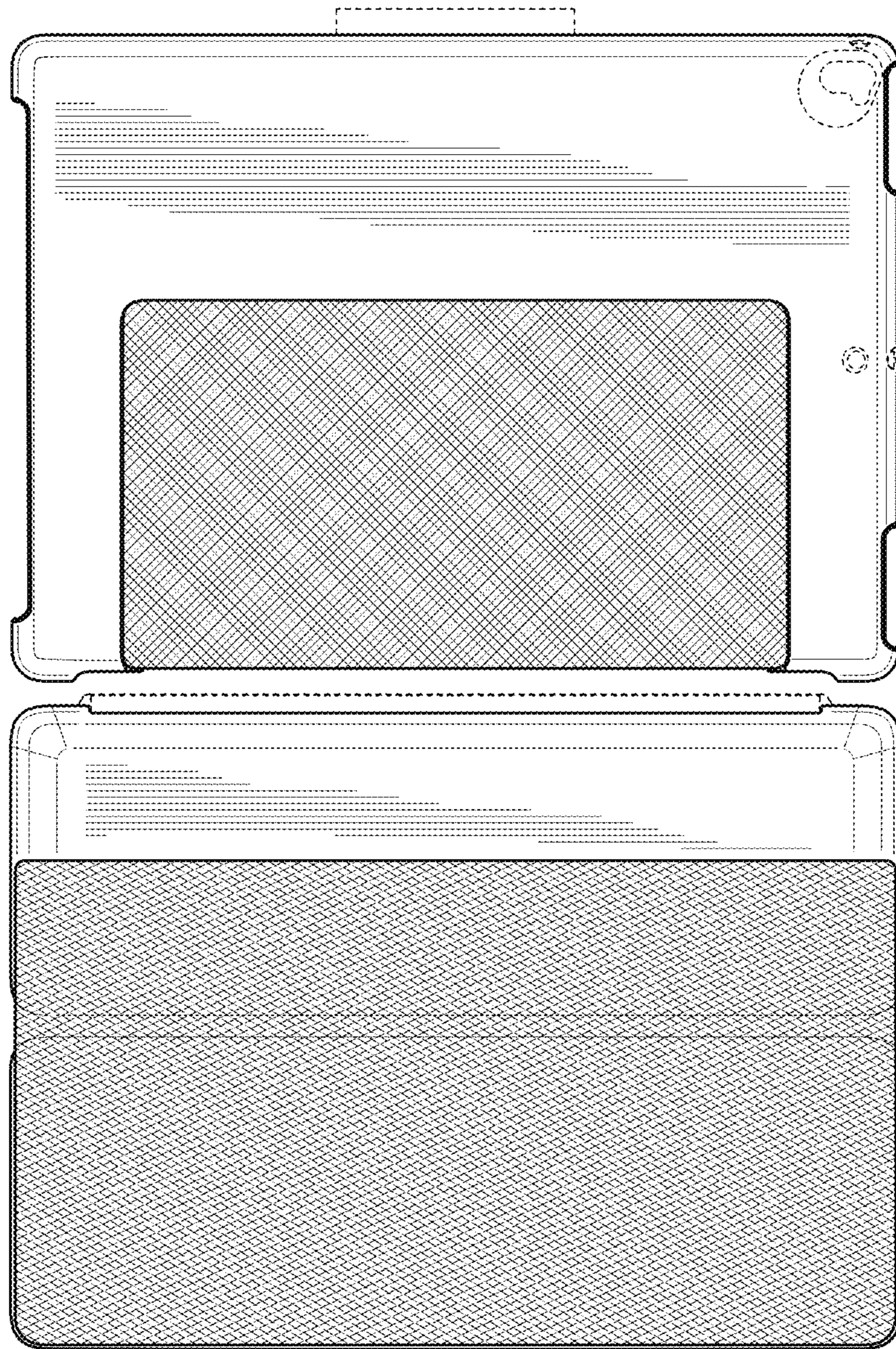

FIG. 4

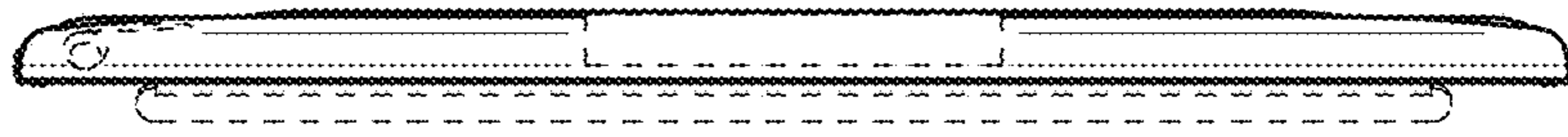

FIG. 5

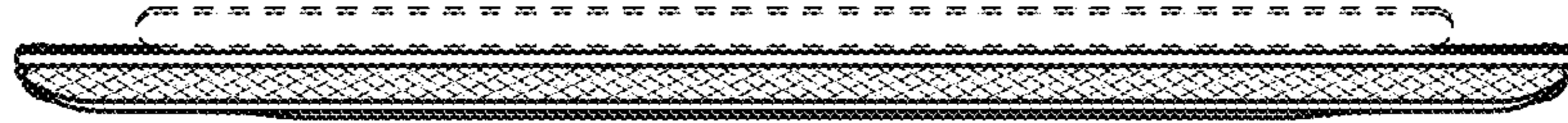

FIG. 6



FIG. 7



FIG. 8

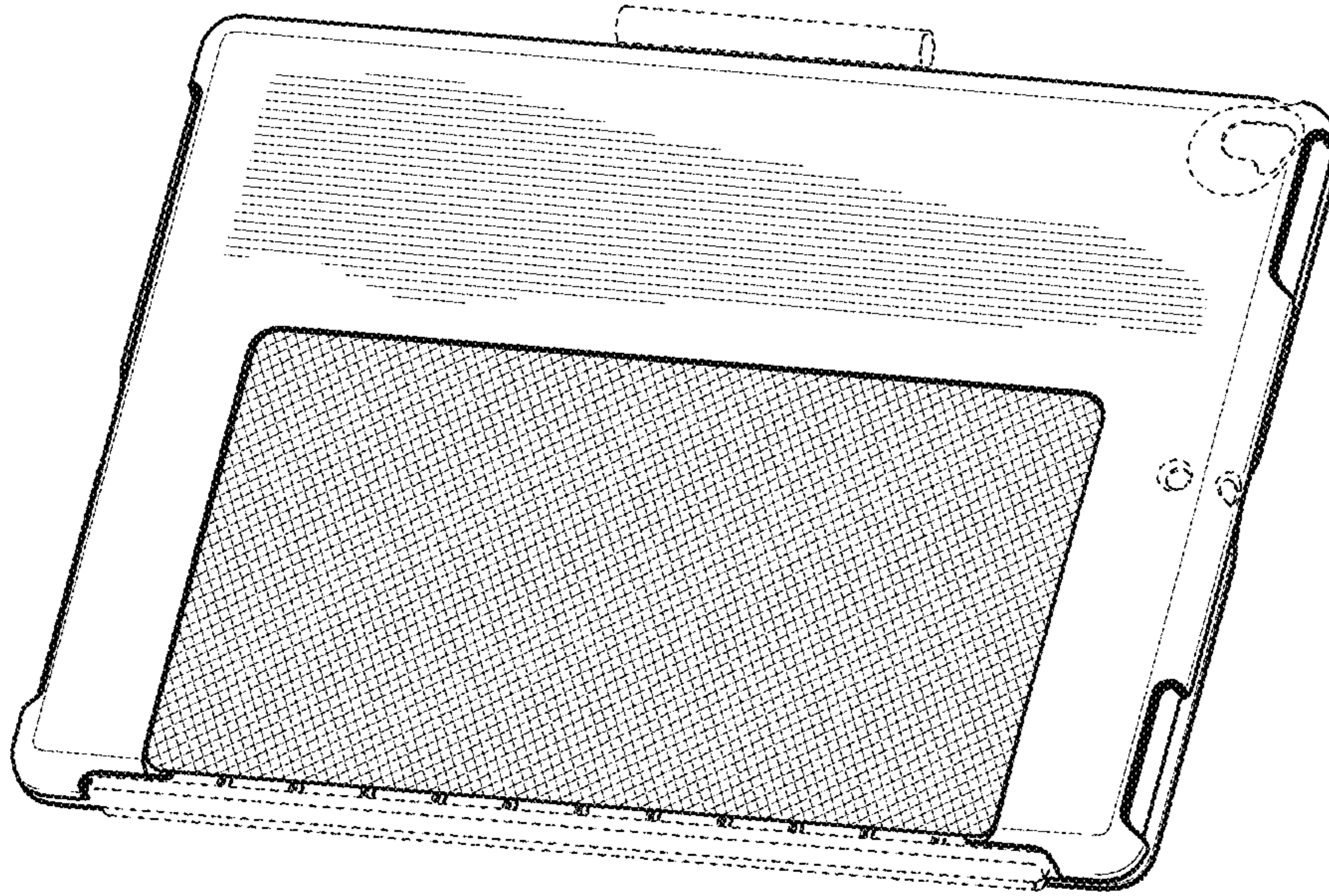

FIG. 9

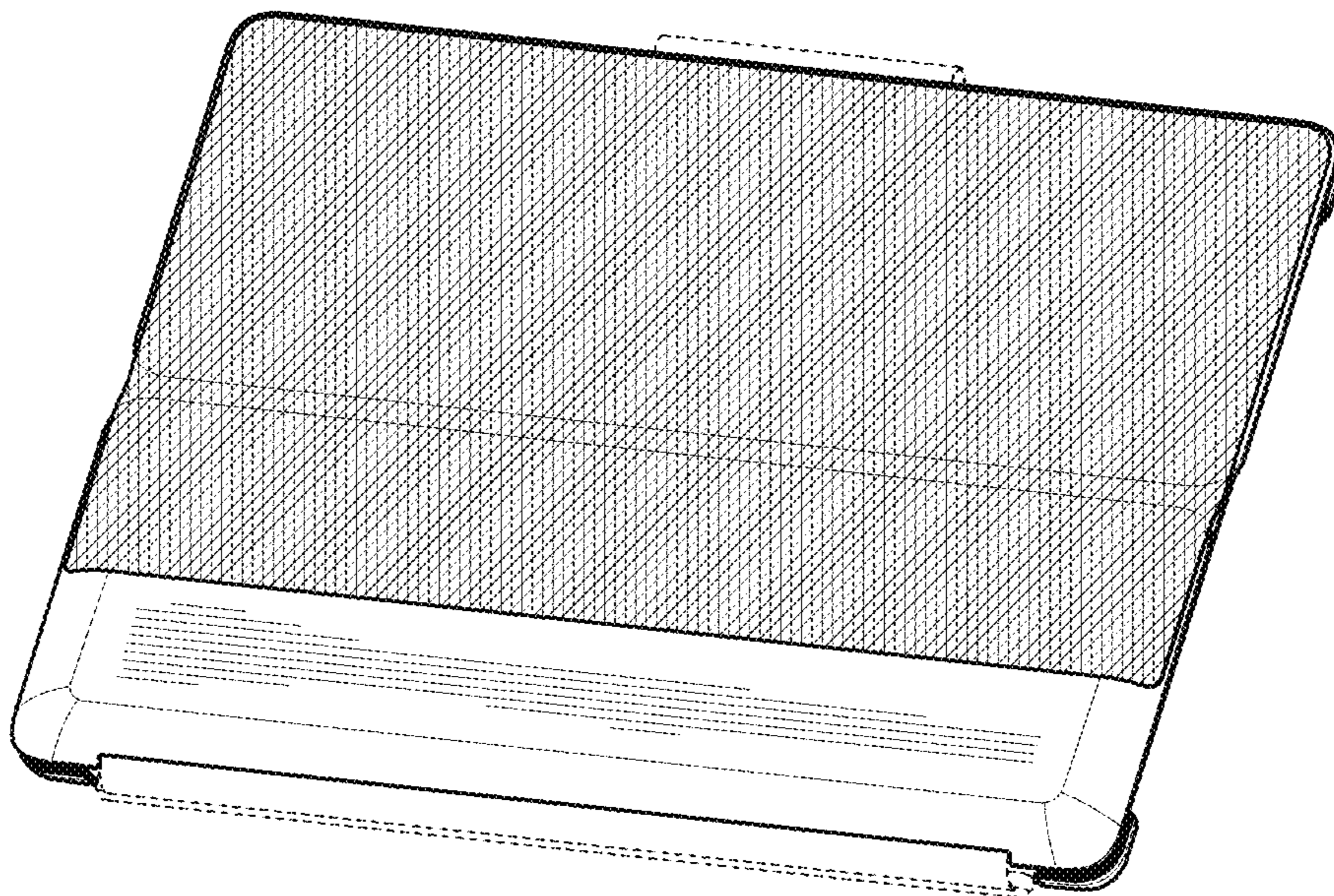

FIG. 10

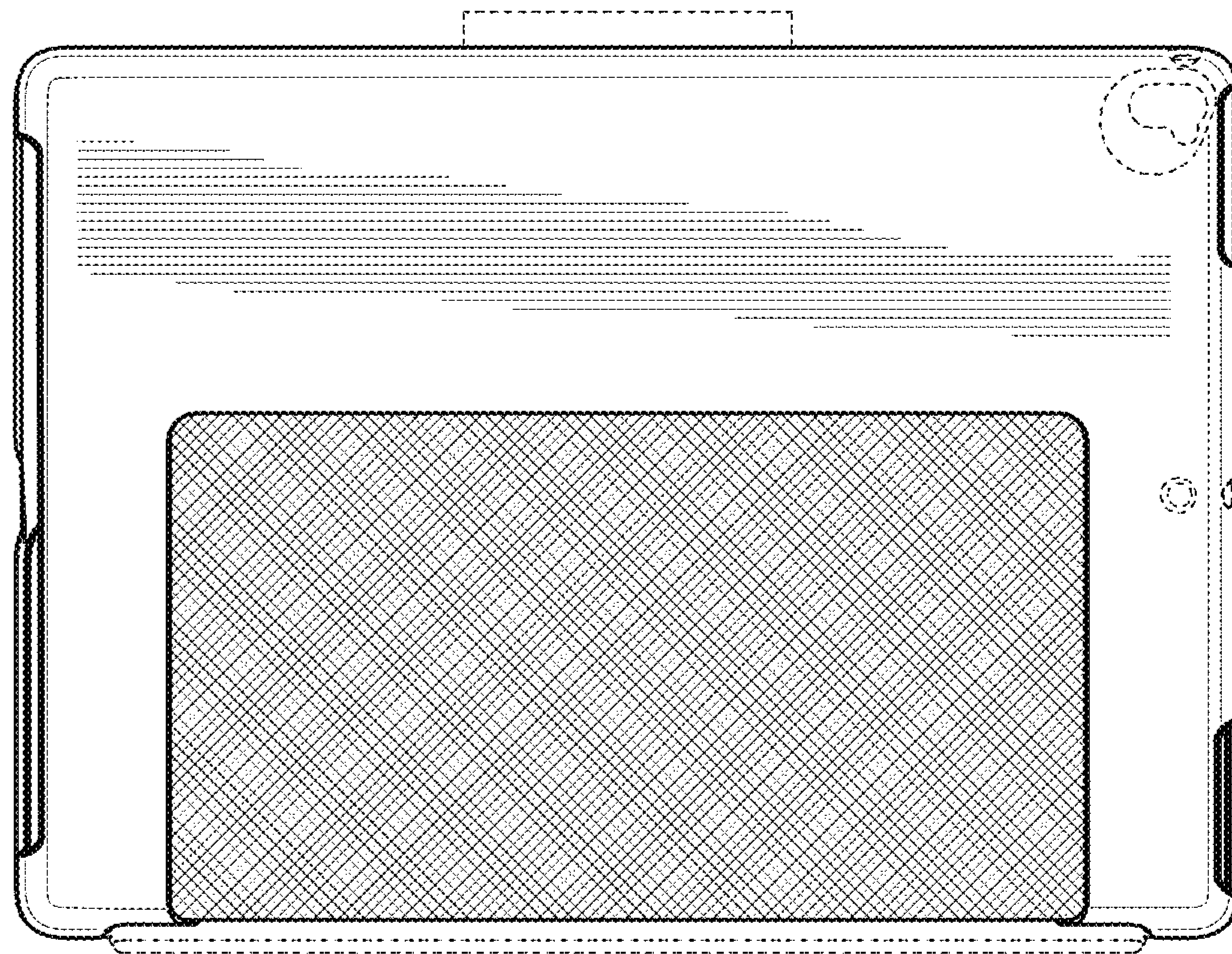

FIG. 11

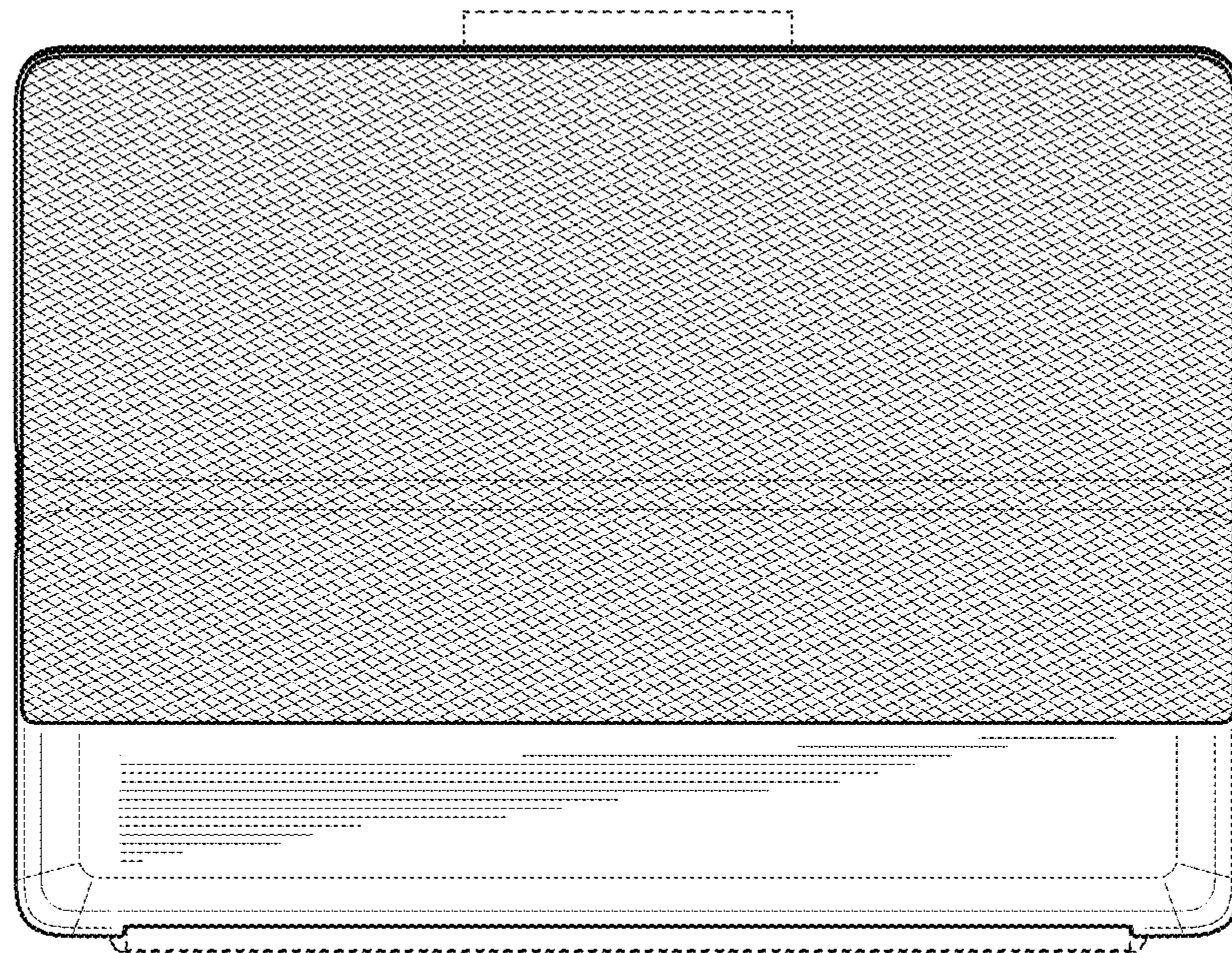

FIG. 12



FIG. 13



FIG. 14

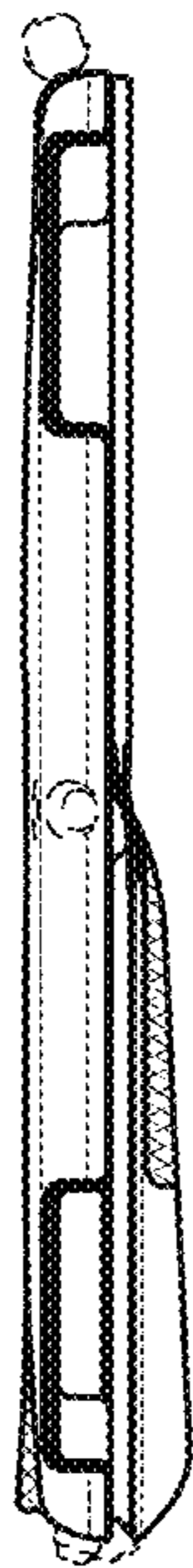

FIG. 15



FIG. 16

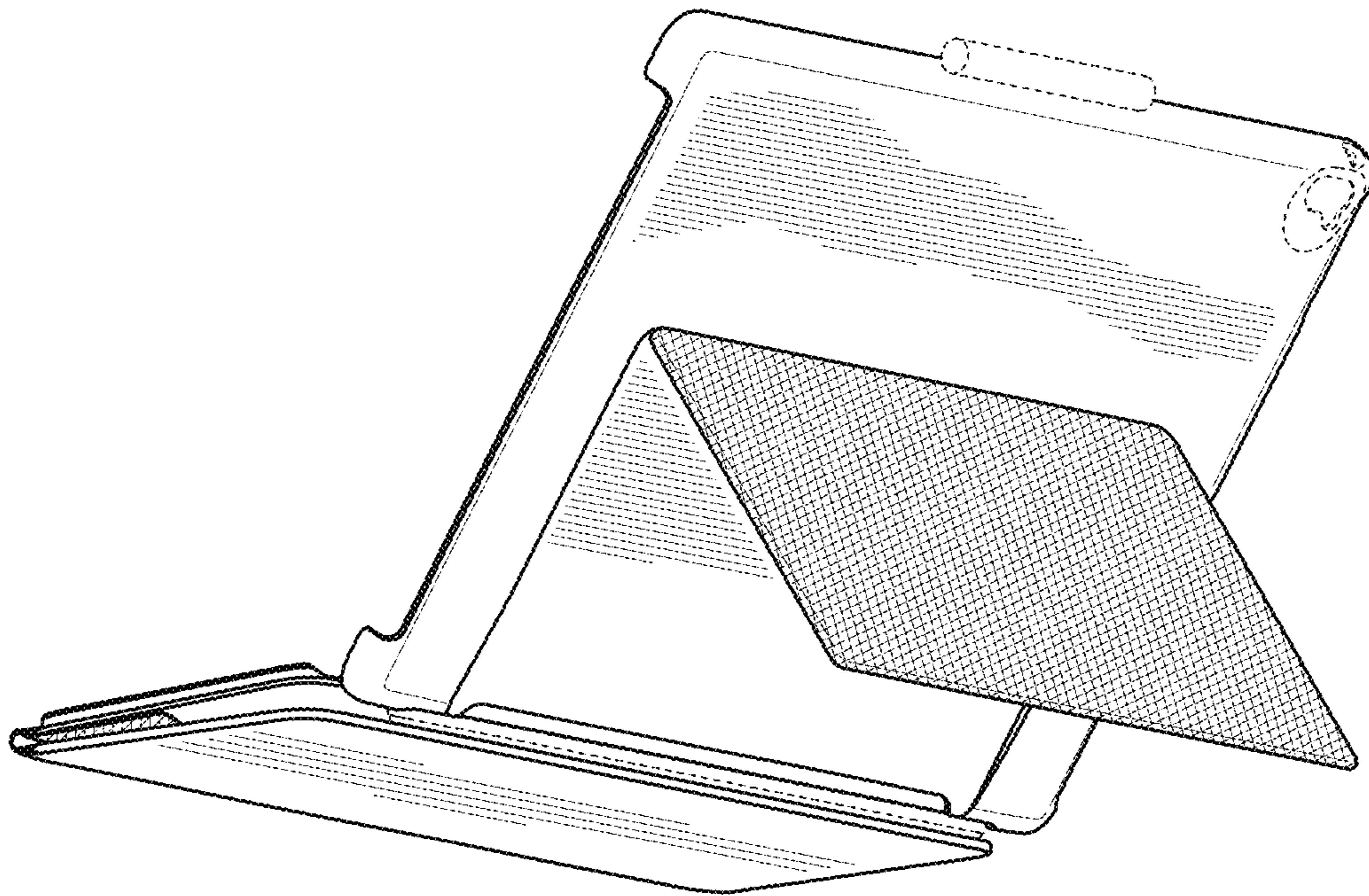

FIG. 17

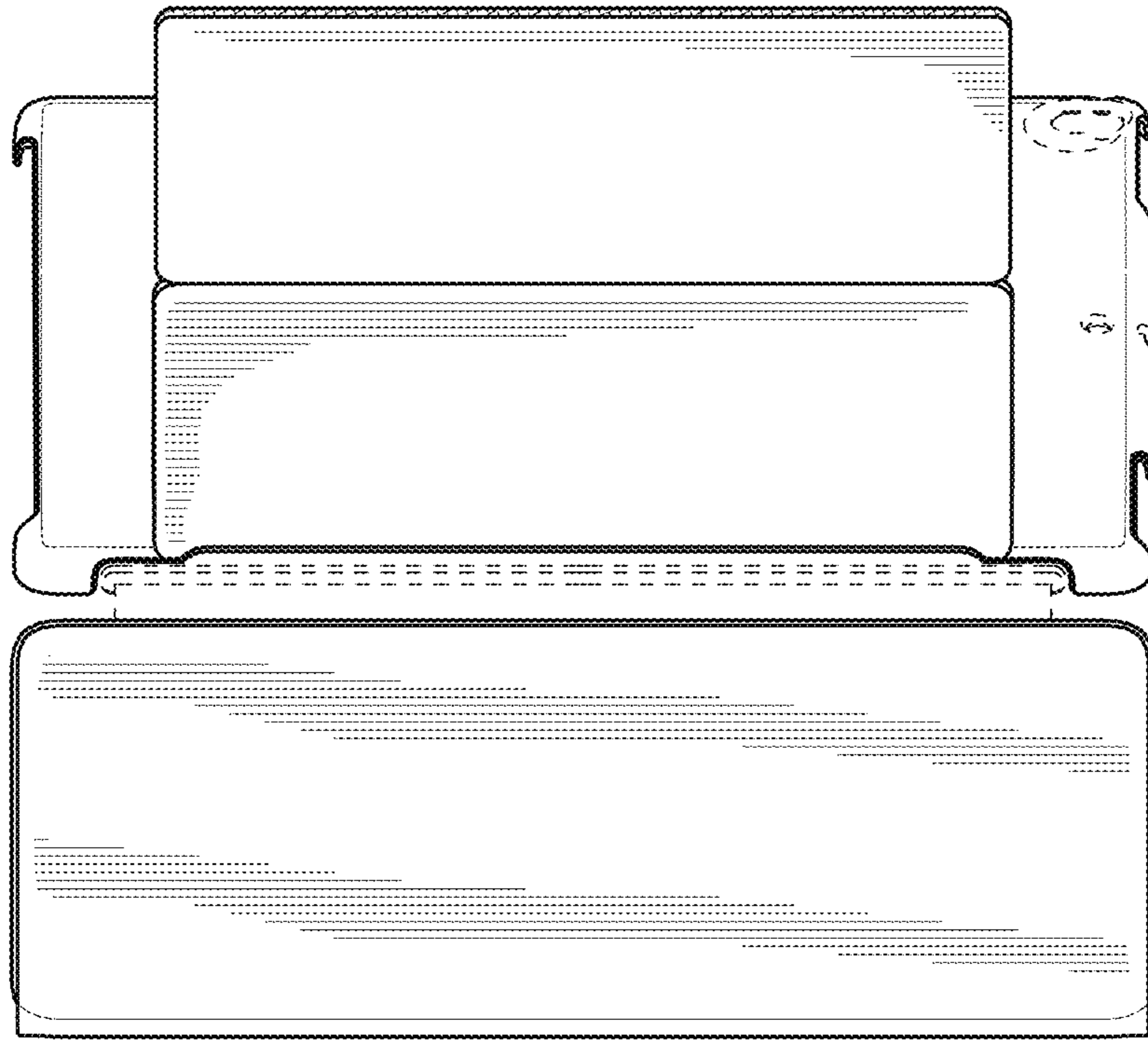

FIG. 18

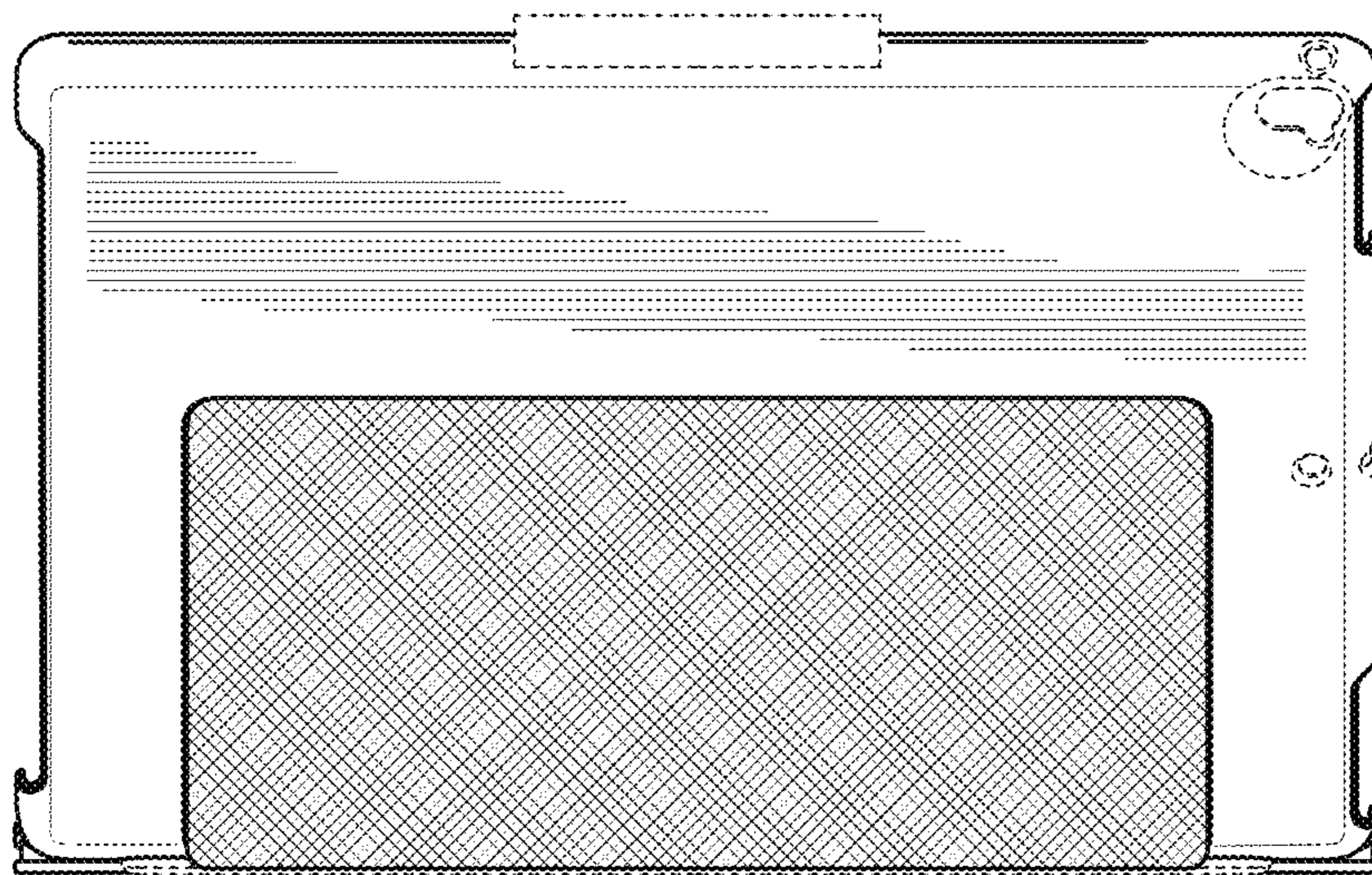

FIG. 19

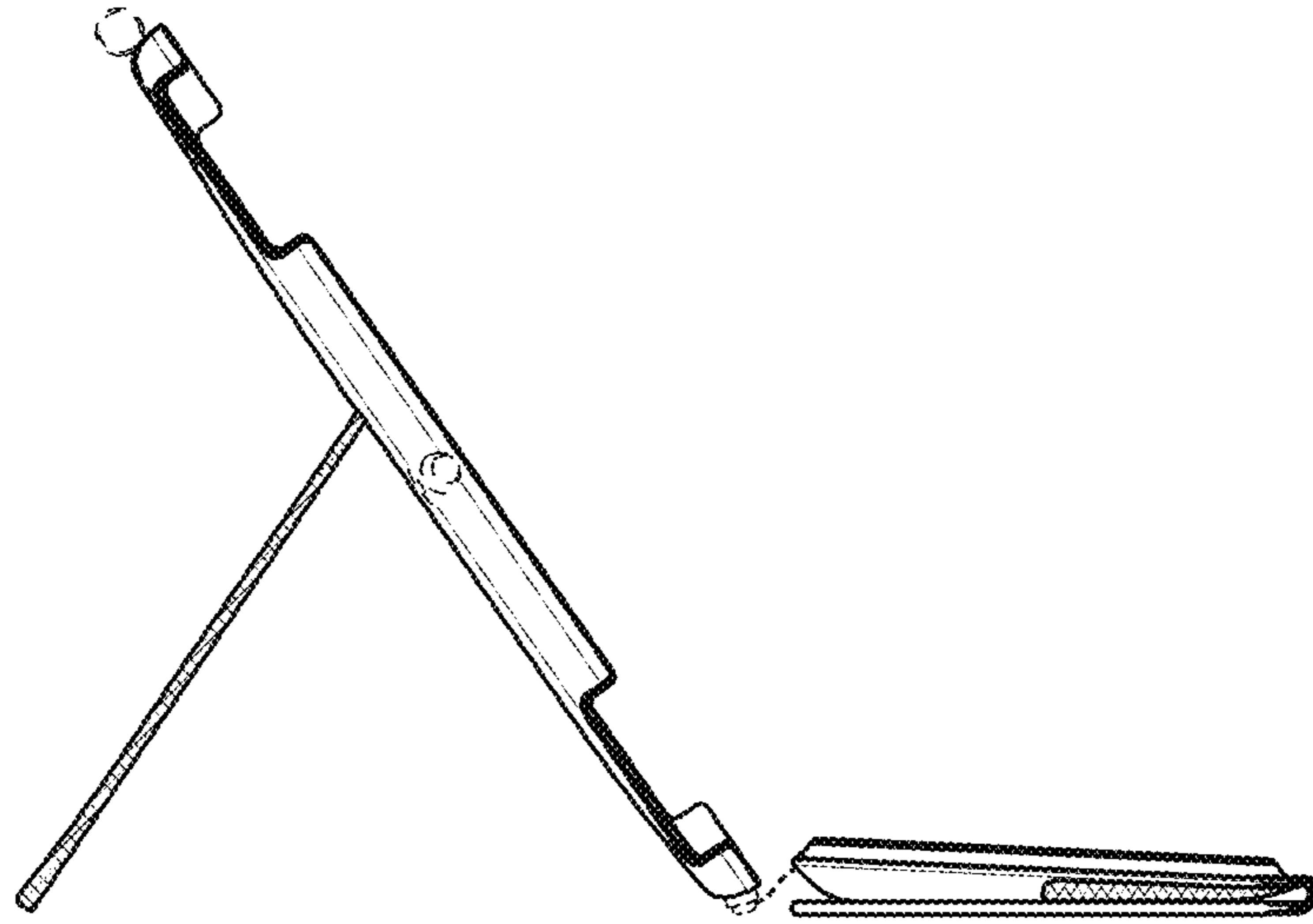

FIG. 20

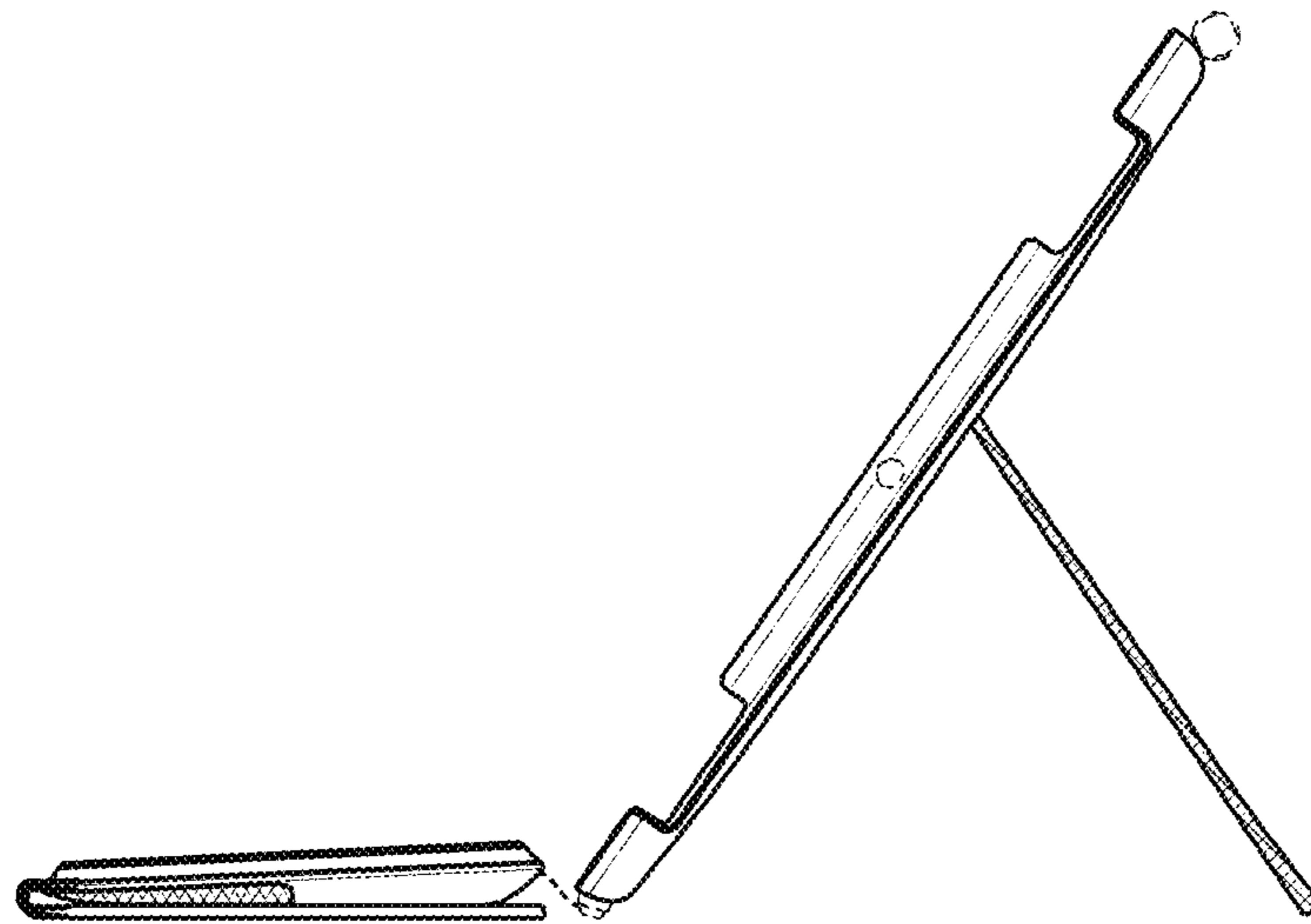

FIG. 21