



US00D832826S

(12) **United States Design Patent** (10) **Patent No.:** **US D832,826 S**
He et al. (45) **Date of Patent:** **** Nov. 6, 2018**

(54) **ANTENNA**

(71) Applicant: **Airgain Incorporated**, San Diego, CA (US)

(72) Inventors: **Ziming He**, Irvine, CA (US); **Yulong Chen**, San Diego, CA (US); **Nando Hunt**, San Diego, CA (US)

(73) Assignee: **Airgain Incorporated**, San Diego, CA (US)

(**) Term: **15 Years**

(21) Appl. No.: **29/568,471**

(22) Filed: **Jun. 17, 2016**

(51) **LOC (11) Cl.** **14-03**

(52) **U.S. Cl.**
USPC **D14/230**

(58) **Field of Classification Search**
USPC D14/138, 230, 231, 232, 234, 235, 236,
D14/237, 238, 238.1, 250, 299, 358;
D13/182

(Continued)

(56) **References Cited**

U.S. PATENT DOCUMENTS

D480,712 S * 10/2003 Noro D14/230
D481,029 S * 10/2003 Noro D14/230

(Continued)

Primary Examiner — Manpreet S Matharu

Assistant Examiner — Mojtaba Tehrani

(74) *Attorney, Agent, or Firm* — Clause Eight IPS;
Michael Catania

(57) **CLAIM**

The ornamental design for an antenna, as shown and described.

DESCRIPTION

FIG. 1 is a front elevation view of the first embodiment of the antenna, showing our new design;

FIG. 1A is a cut-away front elevation view thereof;
FIG. 2 is a side elevation view thereof;
FIG. 2A is a cut-away side elevation view thereof;
FIG. 3 is a side elevation view thereof;
FIG. 3A is a cut-away side elevation view thereof;
FIG. 4 is bottom plan view thereof;
FIG. 5 is a top plan view thereof;
FIG. 6 is a top perspective view thereof;
FIG. 6A is a cut-away top perspective view thereof;
FIG. 7 is a front elevation view of the second embodiment of the antenna, showing our new design;
FIG. 7A is a cut-away front elevation view thereof;
FIG. 8 is a side elevation view thereof;
FIG. 8A is a cut-away side elevation view thereof;
FIG. 9 is a side elevation view thereof;
FIG. 9A is a cut-away side elevation view thereof;
FIG. 10 is top plan view thereof;
FIG. 11 is a bottom plan view thereof;
FIG. 12 is a top perspective view thereof;
FIG. 12A is a cut-away top perspective view thereof;
FIG. 13 is a front elevation view of the third embodiment of the antenna, showing our new design;
FIG. 13A is a cut-away front elevation view thereof;
FIG. 14 is a side elevation view thereof;
FIG. 14A is a cut-away side elevation view thereof;
FIG. 15 is a side elevation view thereof;
FIG. 15A is a cut-away side elevation view thereof;
FIG. 16 is bottom plan view thereof;
FIG. 17 is a top plan view thereof;
FIG. 18 is a top perspective view thereof;
FIG. 18A is a cut-away top perspective view thereof;
FIG. 19 is a front elevation view of the fourth embodiment of the antenna, showing our new design;
FIG. 19A is a cut-away front elevation view thereof;
FIG. 20 is a side elevation view thereof;
FIG. 20A is a cut-away side elevation view thereof;
FIG. 21 is a side elevation view thereof;
FIG. 21A is a cut-away side elevation view thereof;
FIG. 22 is bottom plan view thereof;
FIG. 23 is a top plan view thereof;
FIG. 24 is a top perspective view thereof; and,
FIG. 24A is a cut-away top perspective view thereof.

(Continued)

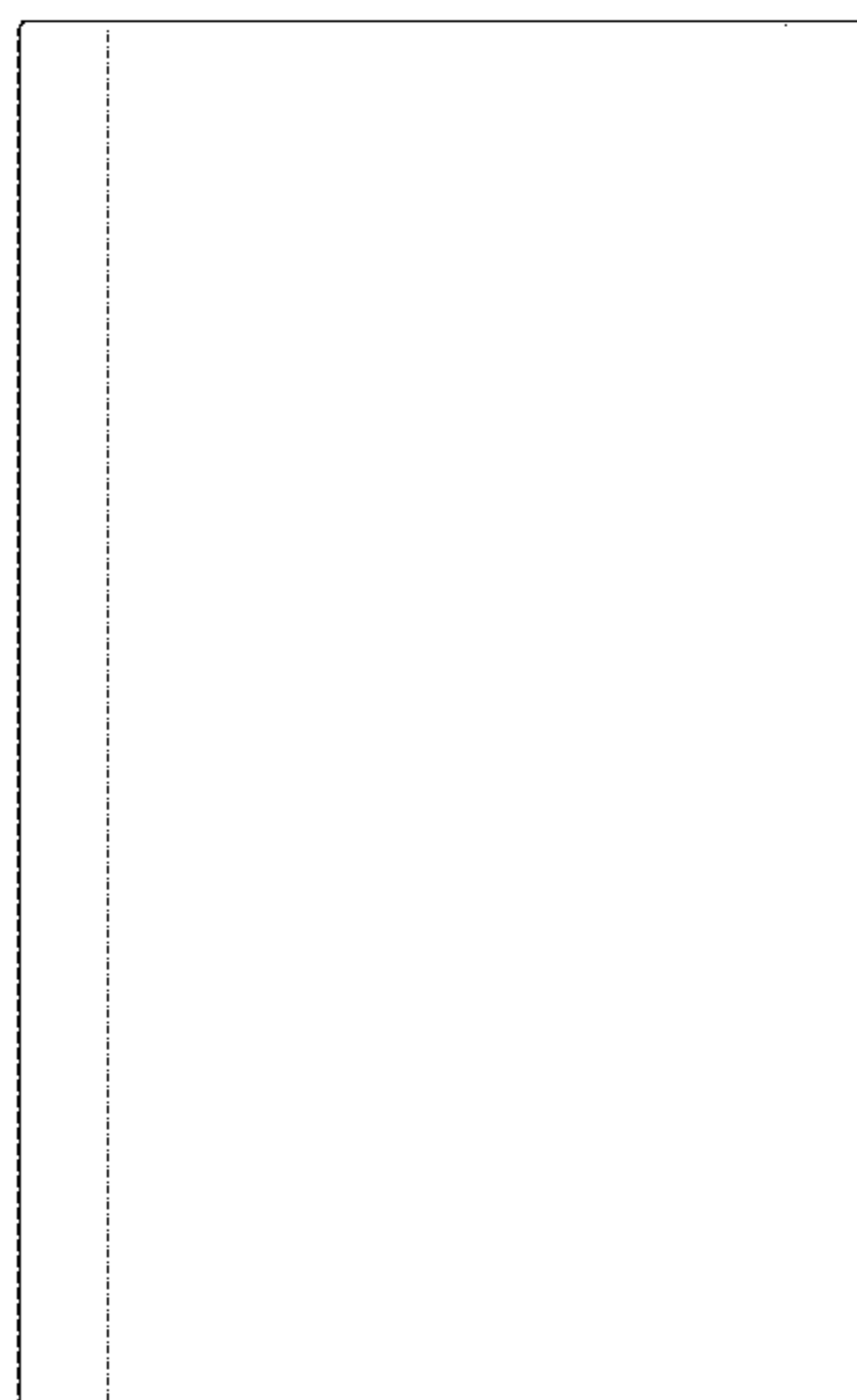

The broken lines illustrated in the figures indicate cutaway views, and form no part of the claimed design.

1 Claim, 28 Drawing Sheets

(58) Field of Classification Search

CPC G01R 29/10; G01S 2013/0245; G01S 2013/0254; G01S 2013/0263; G01S 7/4026; G05B 2219/45001; G06K 19/07773; G06K 19/07775; G06K 19/07777; G08B 13/2468; G08B 13/2477; H01Q 1/088

See application file for complete search history.

(56) References Cited

U.S. PATENT DOCUMENTS

D482,350 S * 11/2003 Noro D14/230
 D483,353 S * 12/2003 Hyogo D14/230
 7,061,437 B2 6/2006 Lin et al.
 7,148,849 B2 12/2006 Lin
 7,215,296 B2 5/2007 Abramov et al.
 D546,821 S 7/2007 Oliver
 D549,696 S 8/2007 Oshima et al.
 7,333,067 B2 2/2008 Hung et al.
 7,336,959 B2 2/2008 Khitrik et al.
 D567,931 S * 4/2008 Hollingsworth D23/388
 D573,589 S 7/2008 Montgomery et al.
 7,405,704 B1 8/2008 Lin et al.
 7,477,195 B2 1/2009 Vance
 D592,195 S 5/2009 Wu et al.
 7,570,215 B2 8/2009 Abramov et al.
 D599,334 S 9/2009 Chiang
 D606,052 S * 12/2009 Noro D14/230
 D606,053 S 12/2009 Wu et al.
 D607,442 S 1/2010 Su et al.
 D608,769 S 1/2010 Bufe
 D612,368 S 3/2010 Yang et al.
 7,705,783 B2 4/2010 Rao et al.
 7,729,662 B2 6/2010 Abramov et al.
 D621,819 S 8/2010 Tsai et al.
 D624,915 S * 10/2010 Ferreira Sanchez D14/385
 7,843,390 B2 11/2010 Liu
 D633,483 S 3/2011 Su et al.
 D635,127 S 3/2011 Tsai et al.
 7,907,971 B2 3/2011 Salo et al.
 D635,560 S 4/2011 Tsai et al.
 D635,963 S 4/2011 Podduturi
 D635,964 S 4/2011 Podduturi
 D635,965 S 4/2011 Mi et al.
 D636,382 S 4/2011 Podduturi
 7,965,242 B2 6/2011 Abramov et al.
 D649,962 S 12/2011 Tseng et al.
 D651,198 S 12/2011 Mi et al.
 D654,059 S 2/2012 Mi et al.
 D654,060 S 2/2012 Ko et al.
 D658,639 S 5/2012 Huang et al.
 D659,129 S 5/2012 Mi et al.

D659,685 S 5/2012 Huang et al.
 D659,688 S 5/2012 Huang et al.
 8,175,036 B2 5/2012 Visuri et al.
 8,184,601 B2 5/2012 Abramov et al.
 D662,916 S 7/2012 Huang et al.
 8,248,970 B2 8/2012 Abramov et al.
 D671,097 S 11/2012 Mi et al.
 8,310,402 B2 11/2012 Yang
 D676,429 S 2/2013 Gosalia et al.
 D678,255 S 3/2013 Ko et al.
 D680,536 S * 4/2013 Tzeng D14/358
 8,423,084 B2 4/2013 Abramov et al.
 D684,565 S 6/2013 Wei
 D685,352 S 7/2013 Wei
 D685,772 S 7/2013 Zheng et al.
 D686,600 S 7/2013 Yang
 D689,474 S 9/2013 Yang et al.
 D692,870 S 11/2013 He
 D694,738 S 12/2013 Yang
 D695,279 S 12/2013 Yang et al.
 D695,280 S 12/2013 Yang et al.
 D703,195 S 4/2014 Zheng
 D703,196 S 4/2014 Zheng
 D706,247 S 6/2014 Zheng et al.
 D706,750 S 6/2014 Bringuir
 D706,751 S 6/2014 Chang et al.
 D708,602 S 7/2014 Gosalia et al.
 D709,053 S 7/2014 Chang et al.
 D710,832 S * 8/2014 Yang D14/230
 D710,833 S 8/2014 Zheng et al.
 D713,405 S * 9/2014 Akana D14/349
 8,854,265 B1 10/2014 Yang et al.
 D716,775 S 11/2014 Bidermann
 D733,104 S * 6/2015 Yang D14/230
 D747,297 S * 1/2016 He D14/230
 D754,108 S * 4/2016 Yang D14/230
 D785,604 S * 5/2017 Chang D14/230
 D785,609 S * 5/2017 Bellows D14/230
 D797,081 S * 9/2017 Liang D14/230
 D798,846 S * 10/2017 Chang D14/230
 2002/0003499 A1 1/2002 Kouam et al.
 2004/0222936 A1 11/2004 Hung et al.
 2005/0073462 A1 4/2005 Lin et al.
 2005/0190108 A1 9/2005 Lin et al.
 2006/0208900 A1 9/2006 Hazouri
 2007/0030203 A1 2/2007 Tsai et al.
 2008/0150829 A1 6/2008 Lin et al.
 2008/0252552 A1 * 10/2008 Goebel H01Q 1/246
 343/872
 2009/0002244 A1 1/2009 Woo
 2009/0058739 A1 3/2009 Kanishi
 2009/0135072 A1 5/2009 Ke et al.
 2009/0262028 A1 10/2009 Murnbru et al.
 2010/0188297 A1 7/2010 Chen et al.
 2010/0309067 A1 12/2010 Tsau et al.
 2011/0006950 A1 1/2011 Park et al.
 2012/0038514 A1 2/2012 Bang
 2012/0218167 A1 * 8/2012 He H01Q 1/38
 343/872
 2012/0229348 A1 9/2012 Chiang
 2012/0242546 A1 9/2012 Hu et al.

* cited by examiner

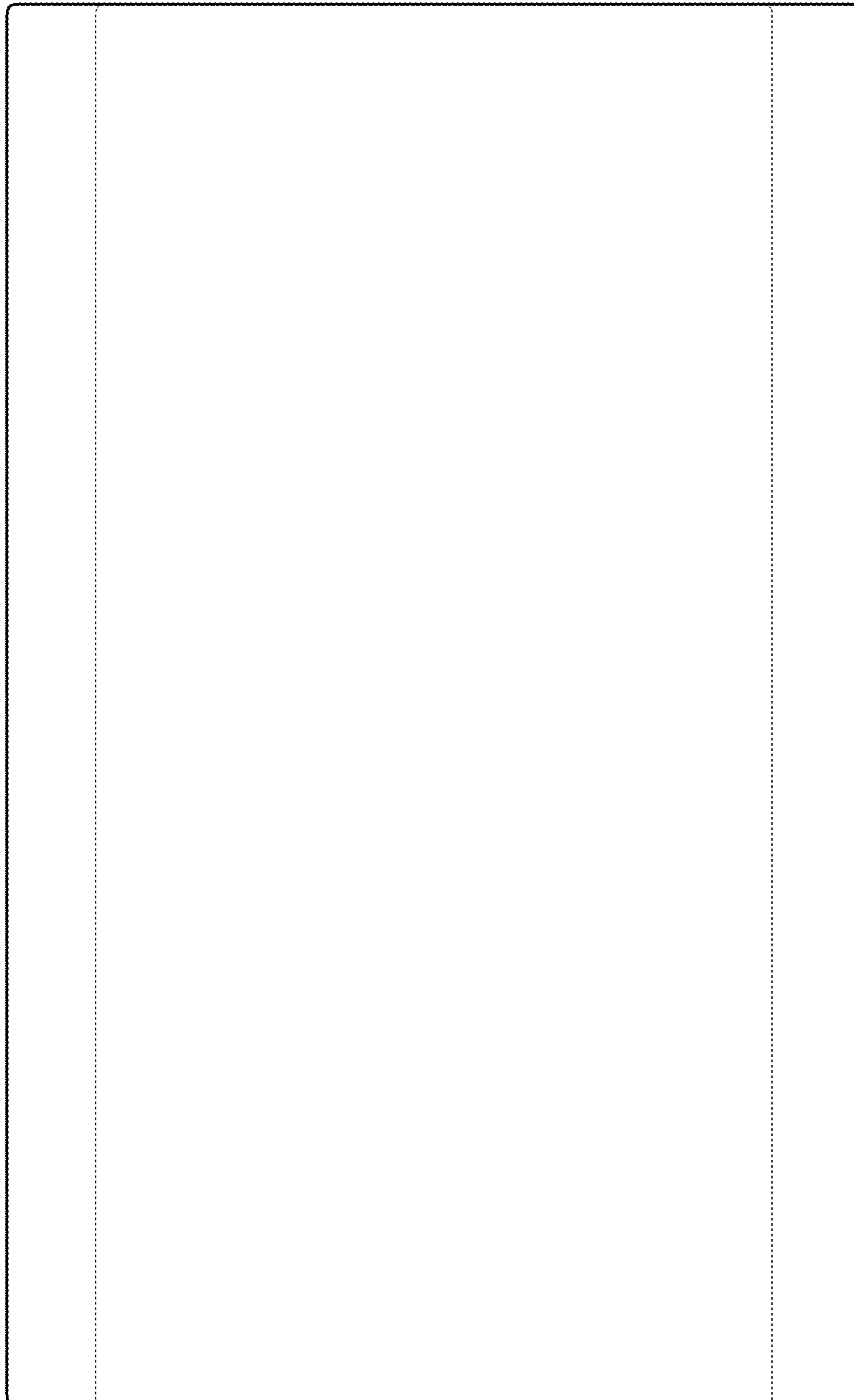

FIG. 1

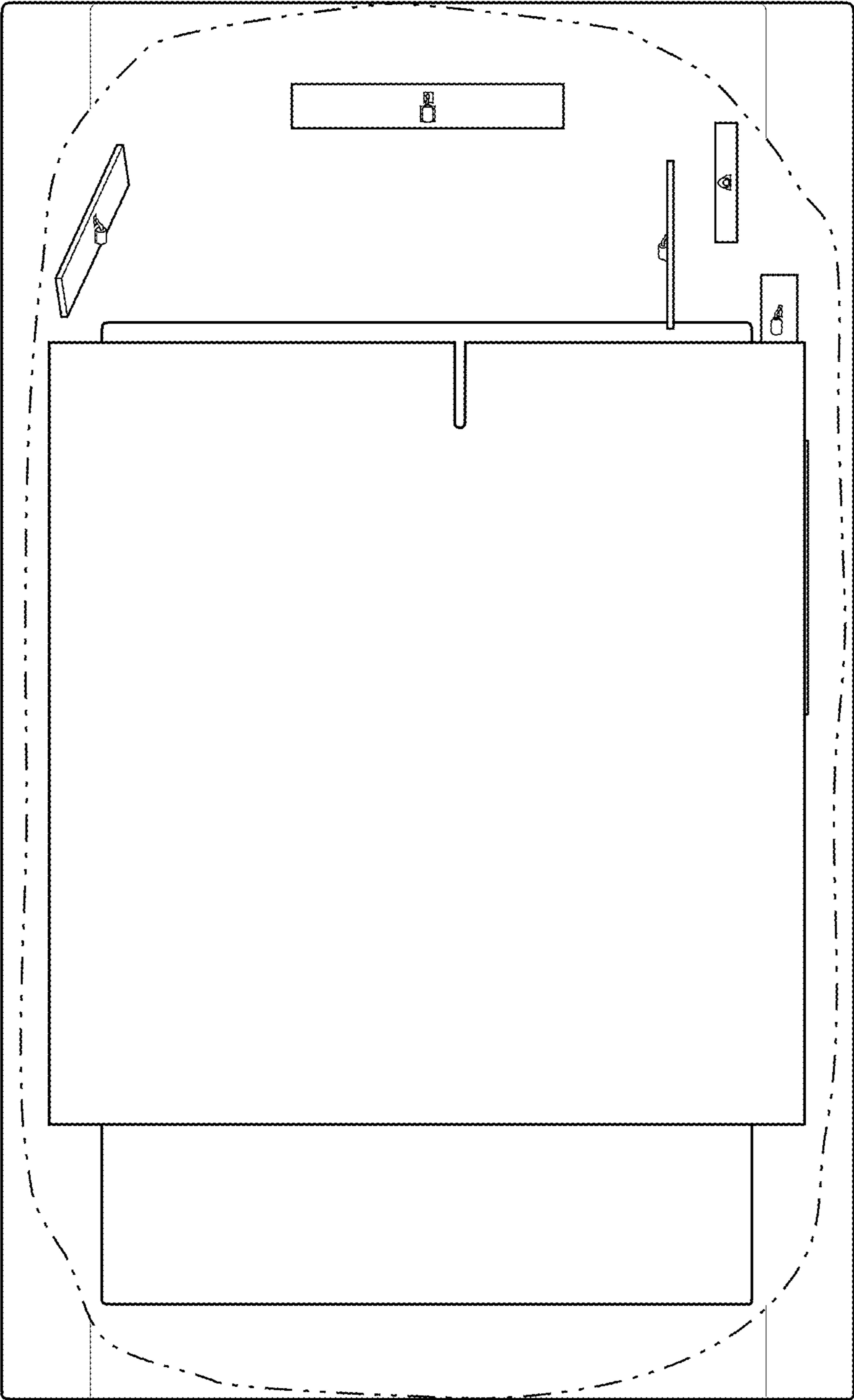

FIG. 1A

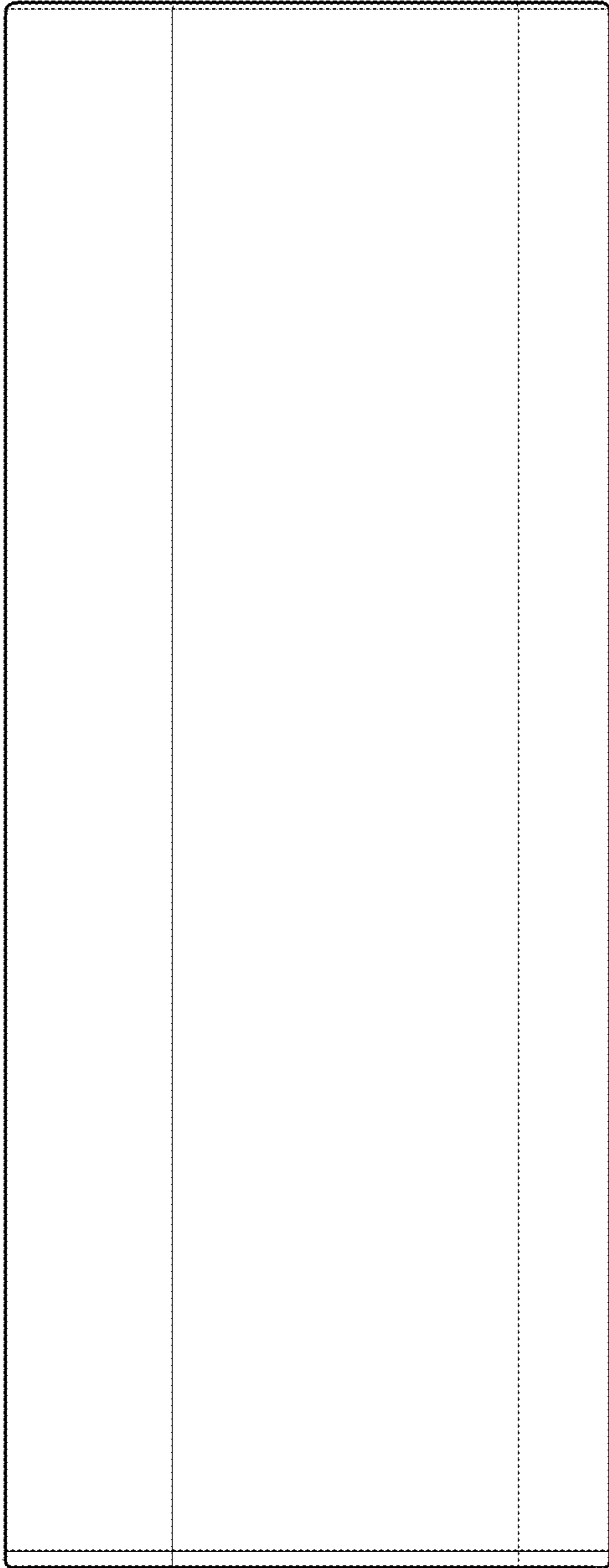

FIG. 2

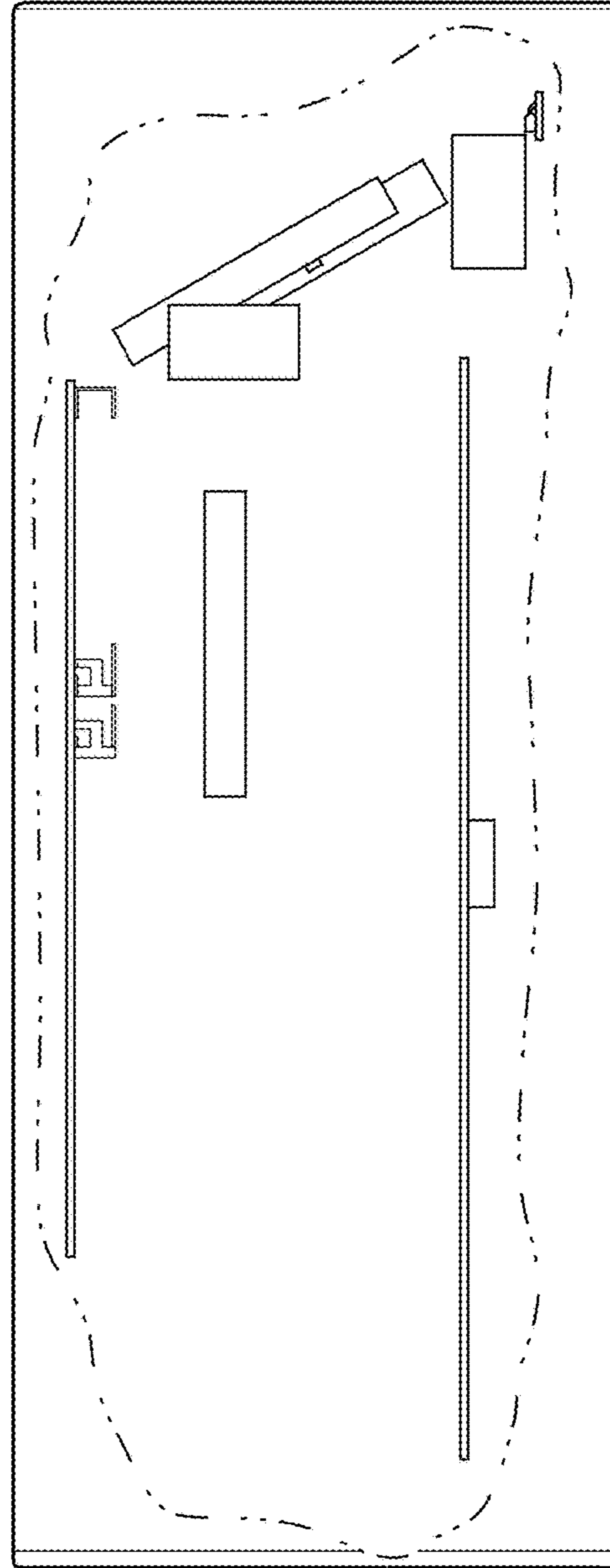

FIG. 2A

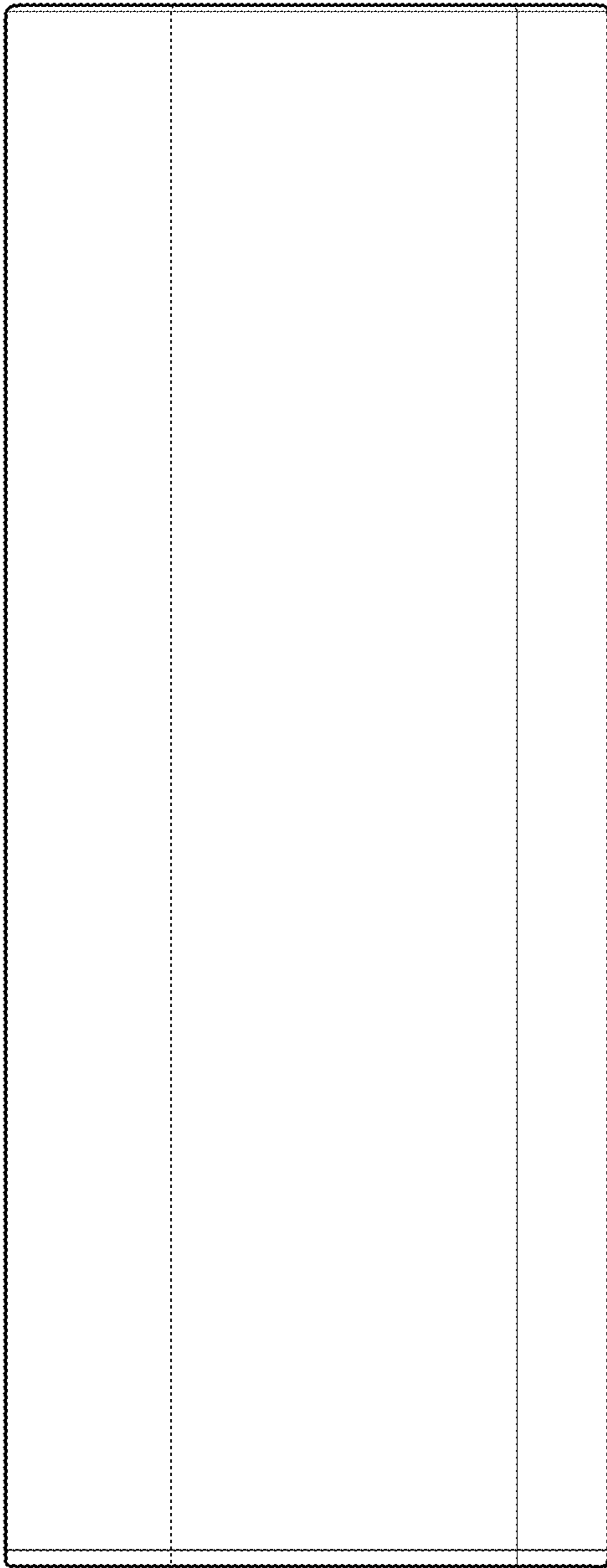

FIG. 3

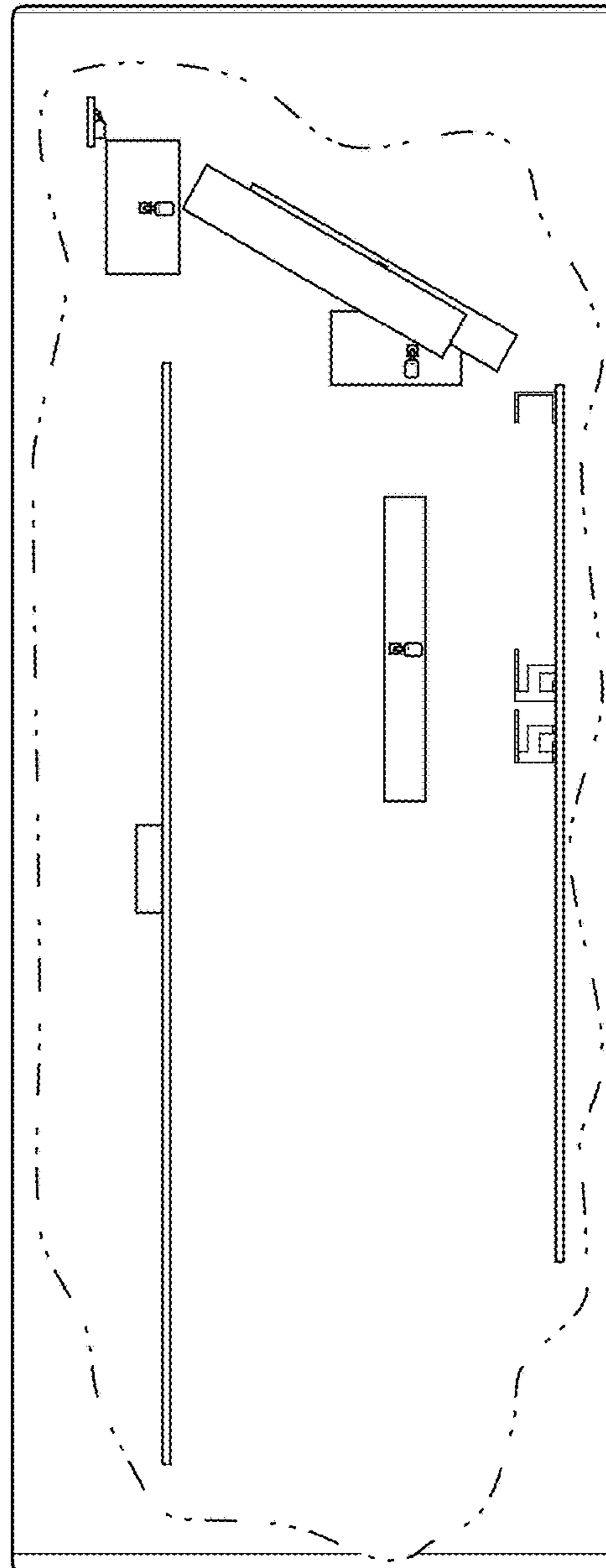

FIG. 3A

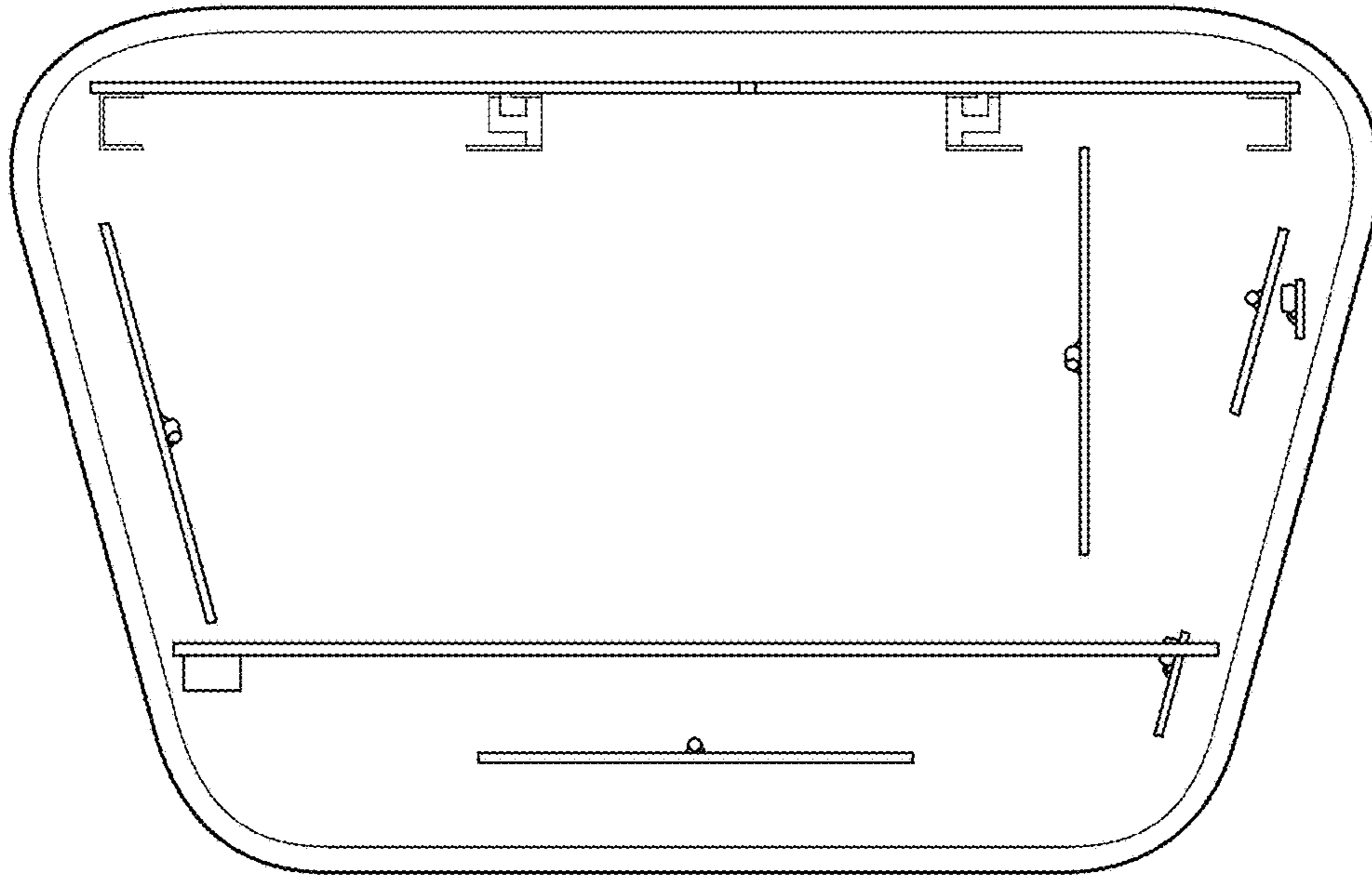

FIG. 4

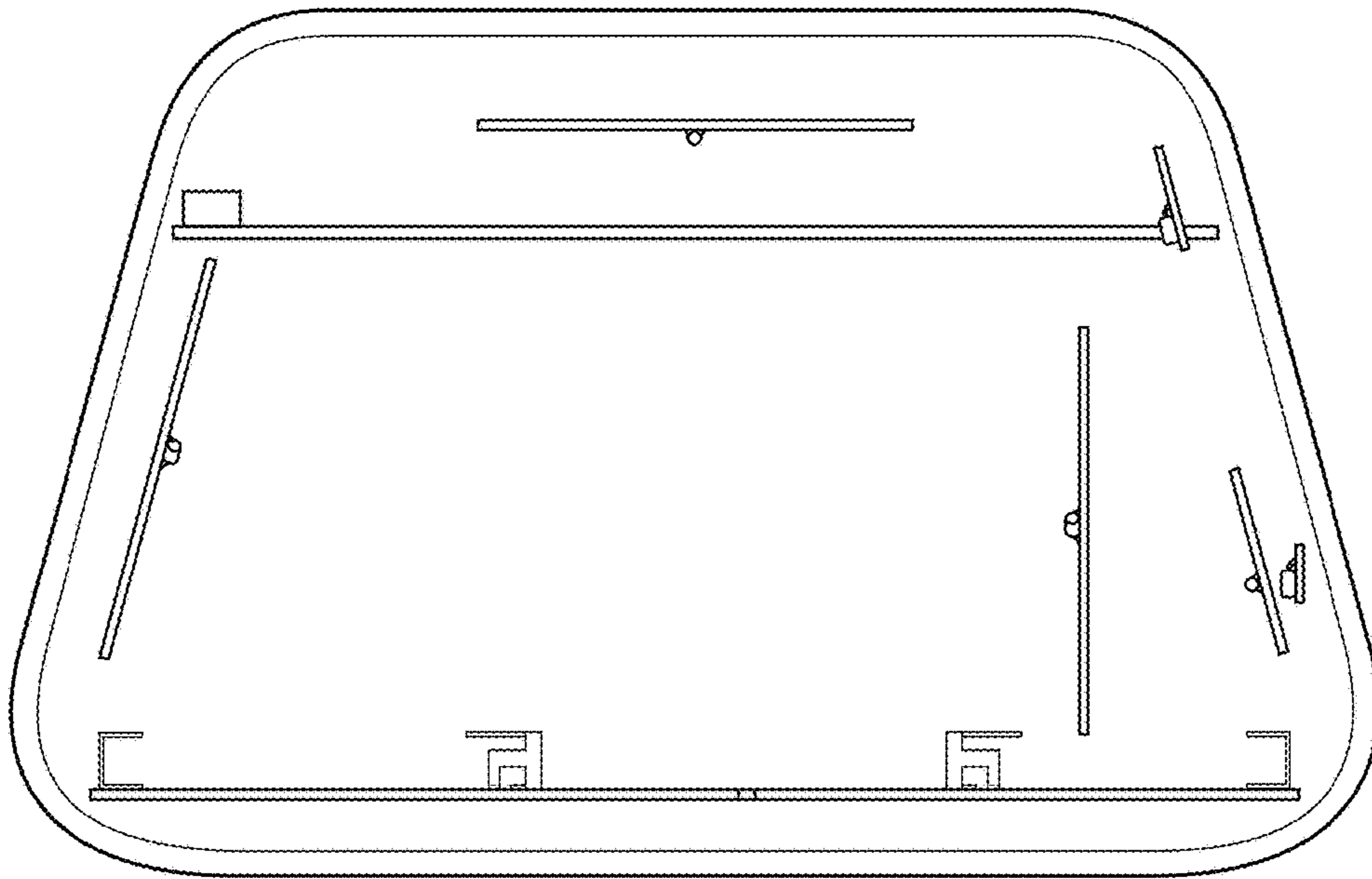

FIG. 5

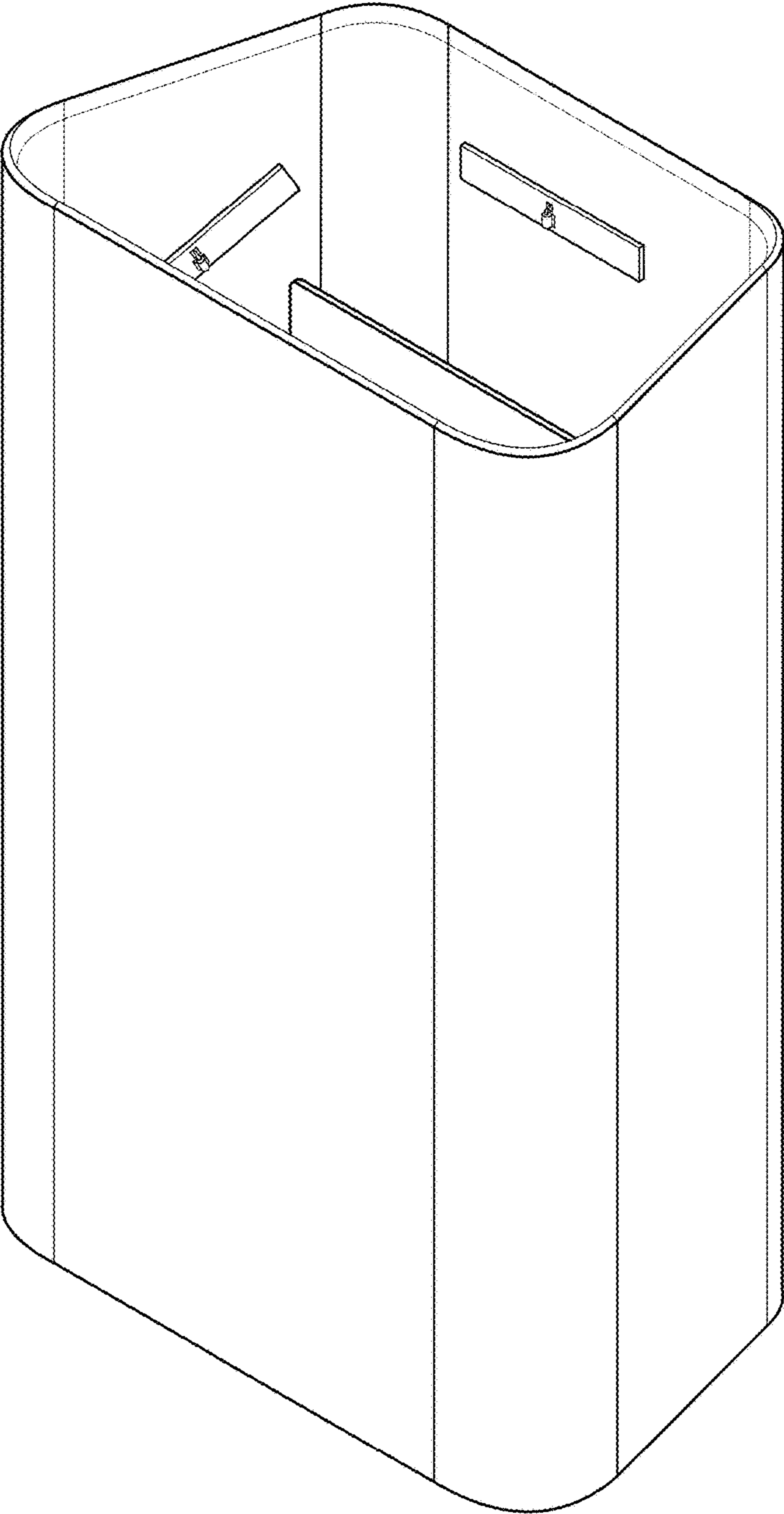

FIG. 6

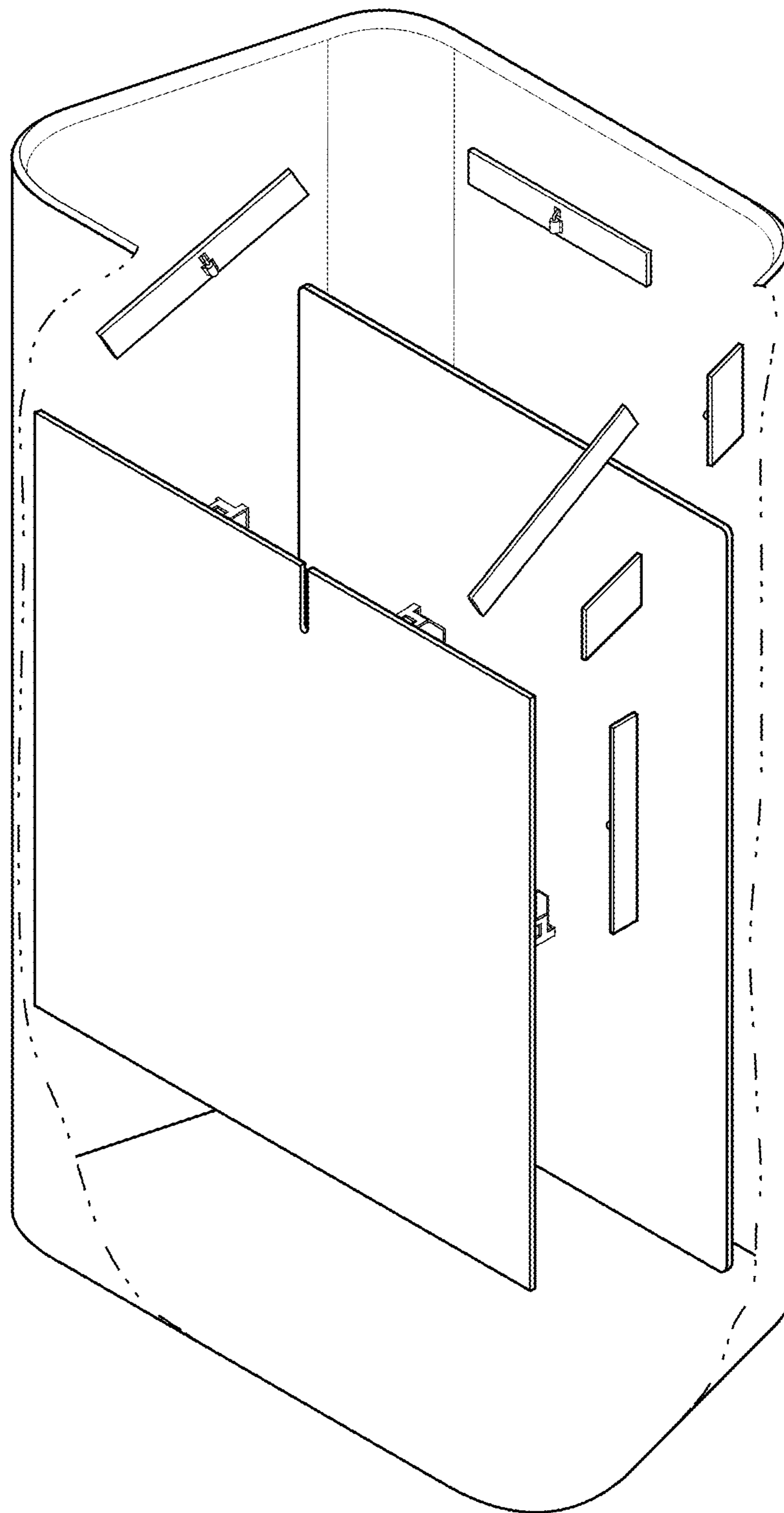

FIG. 6A

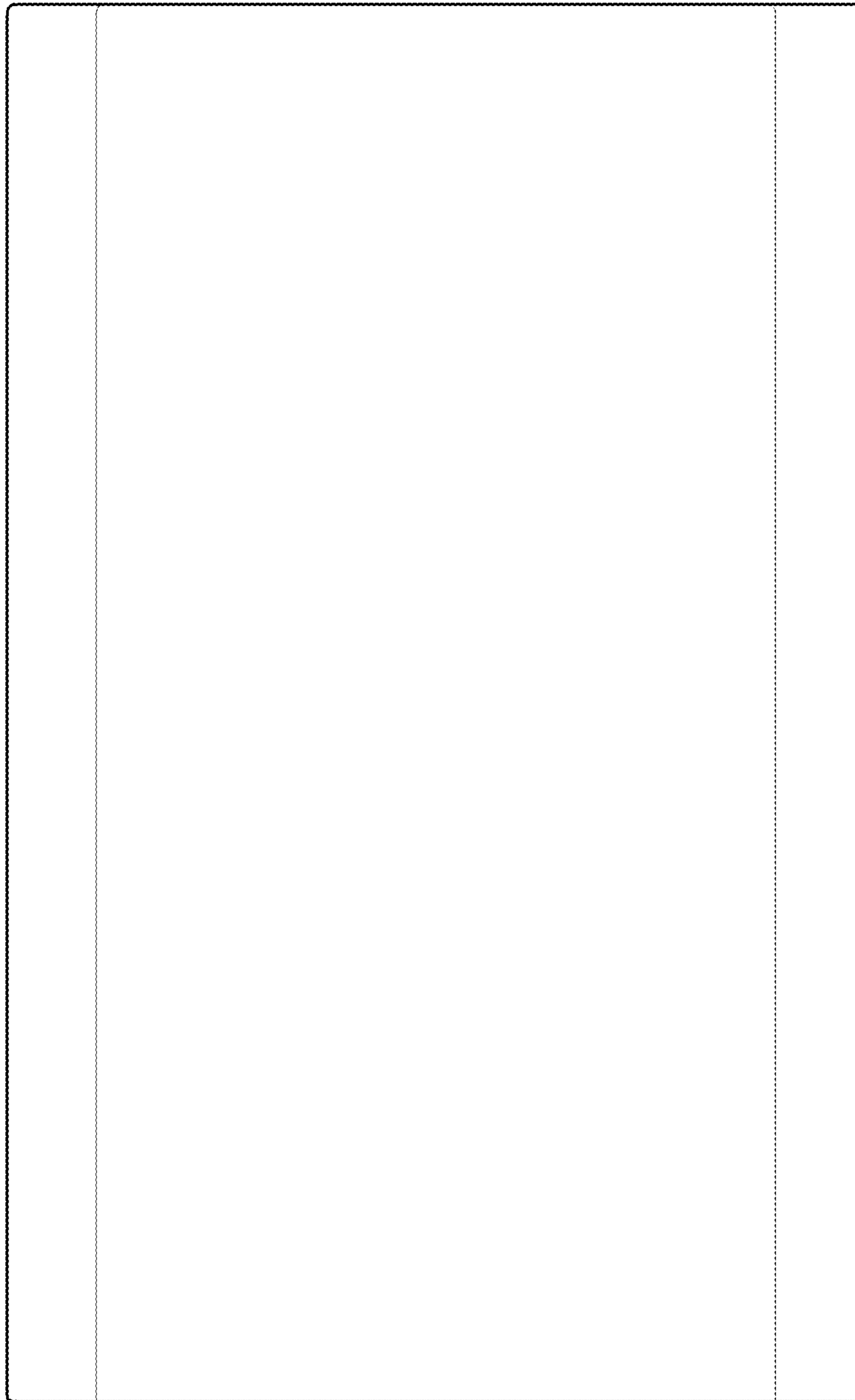

FIG. 7

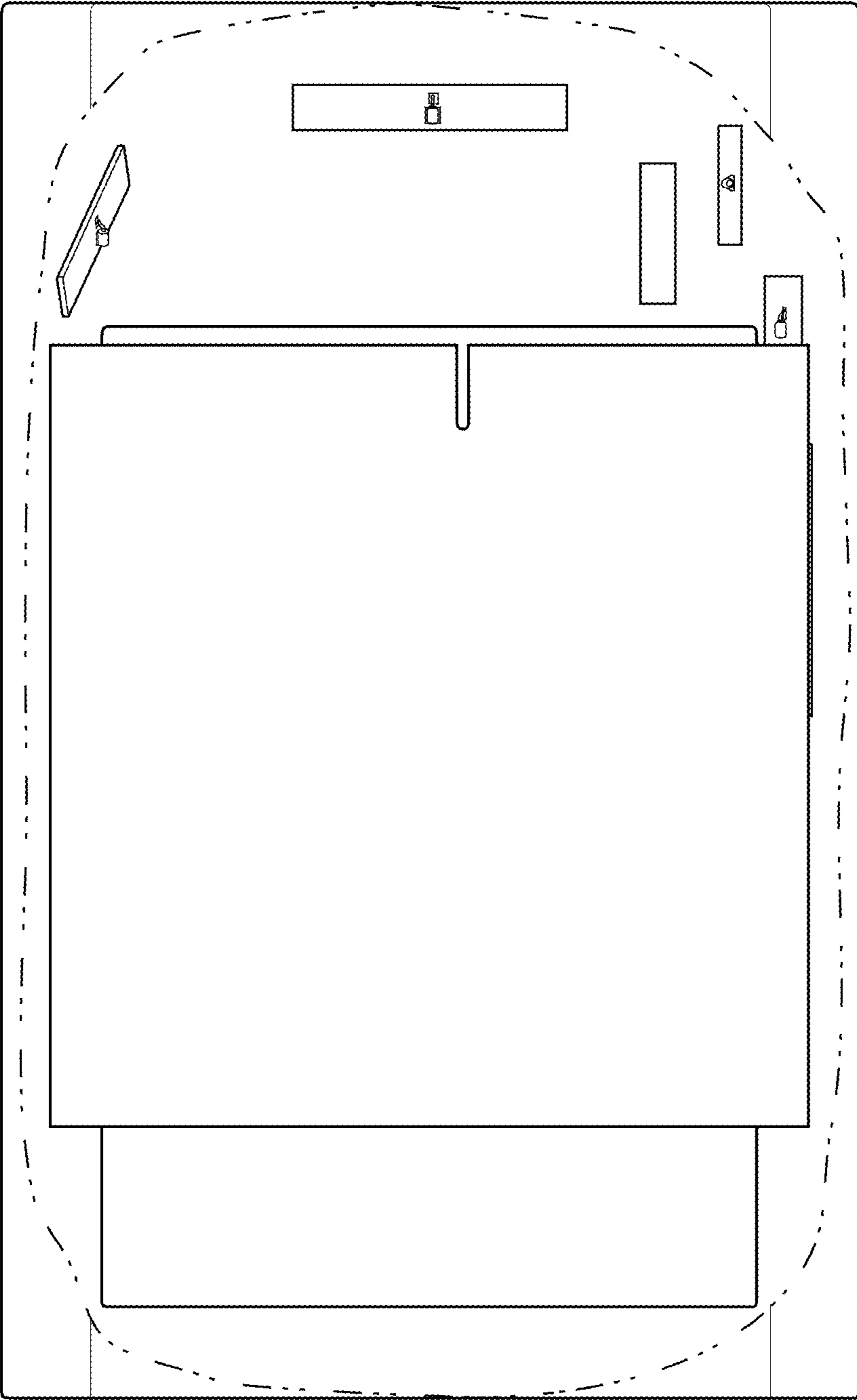

FIG. 7A

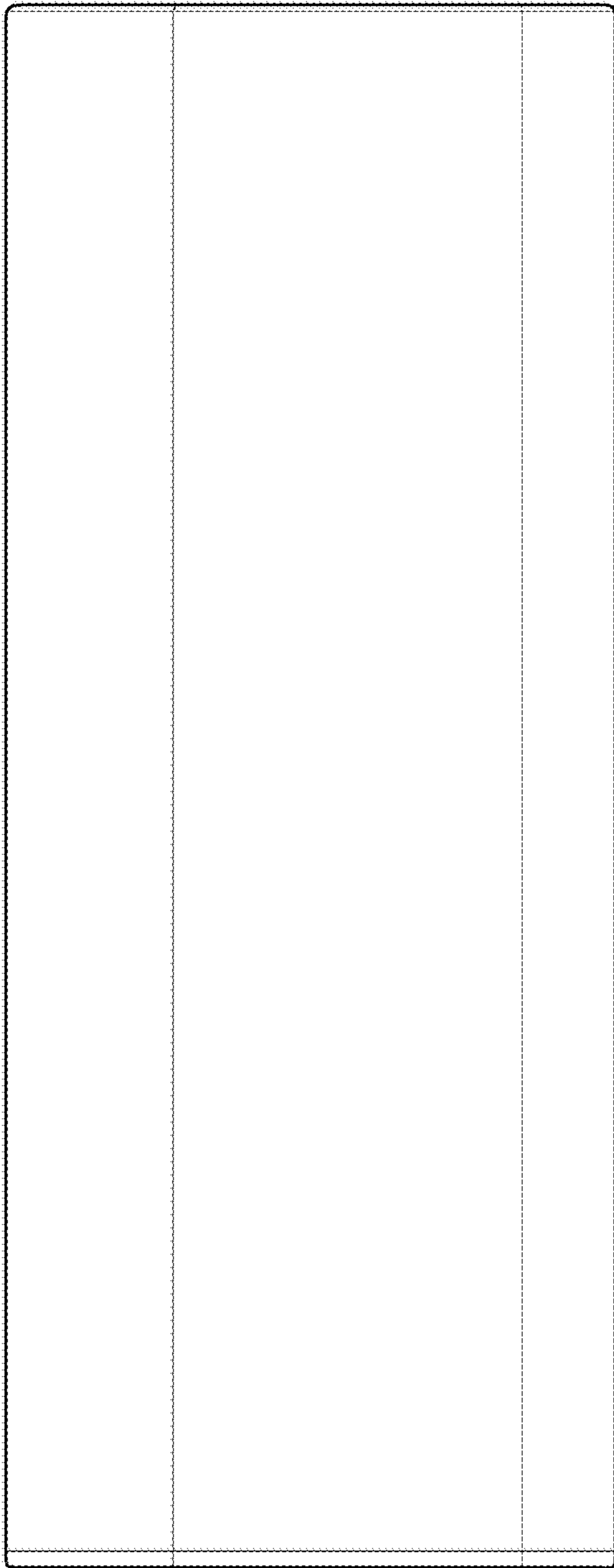

FIG. 8

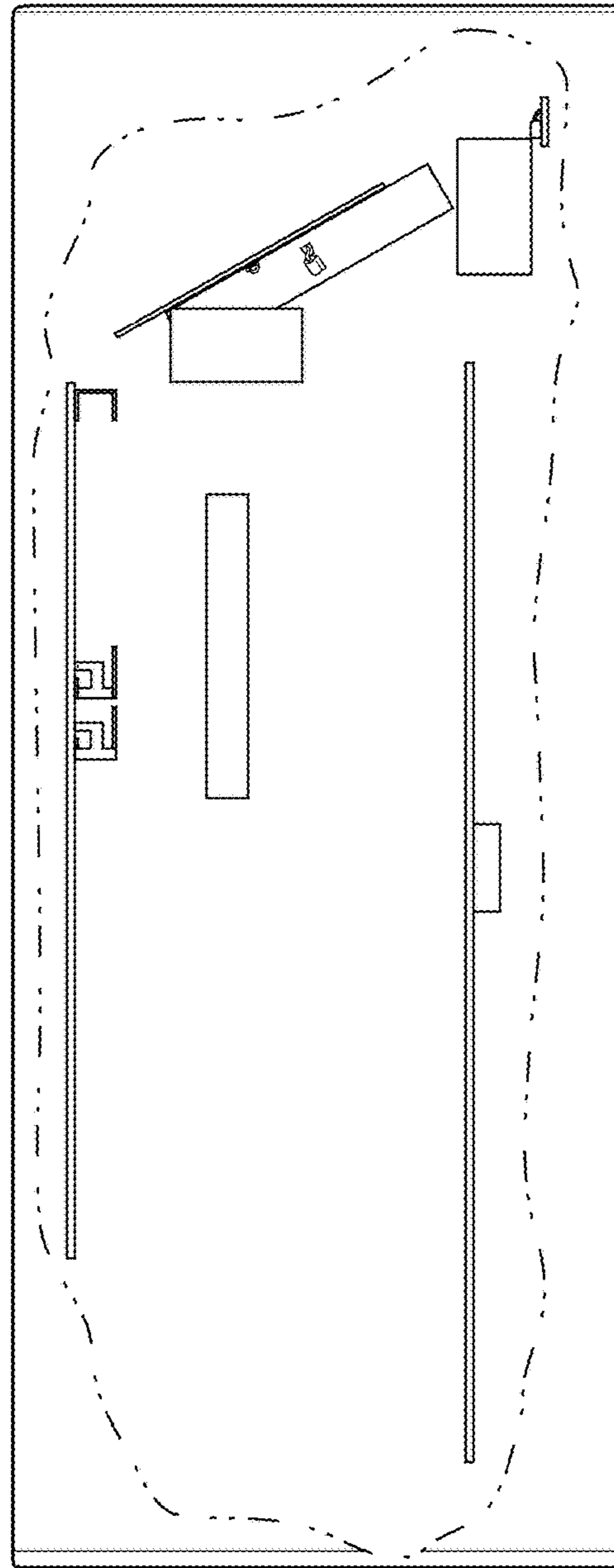

FIG. 8A

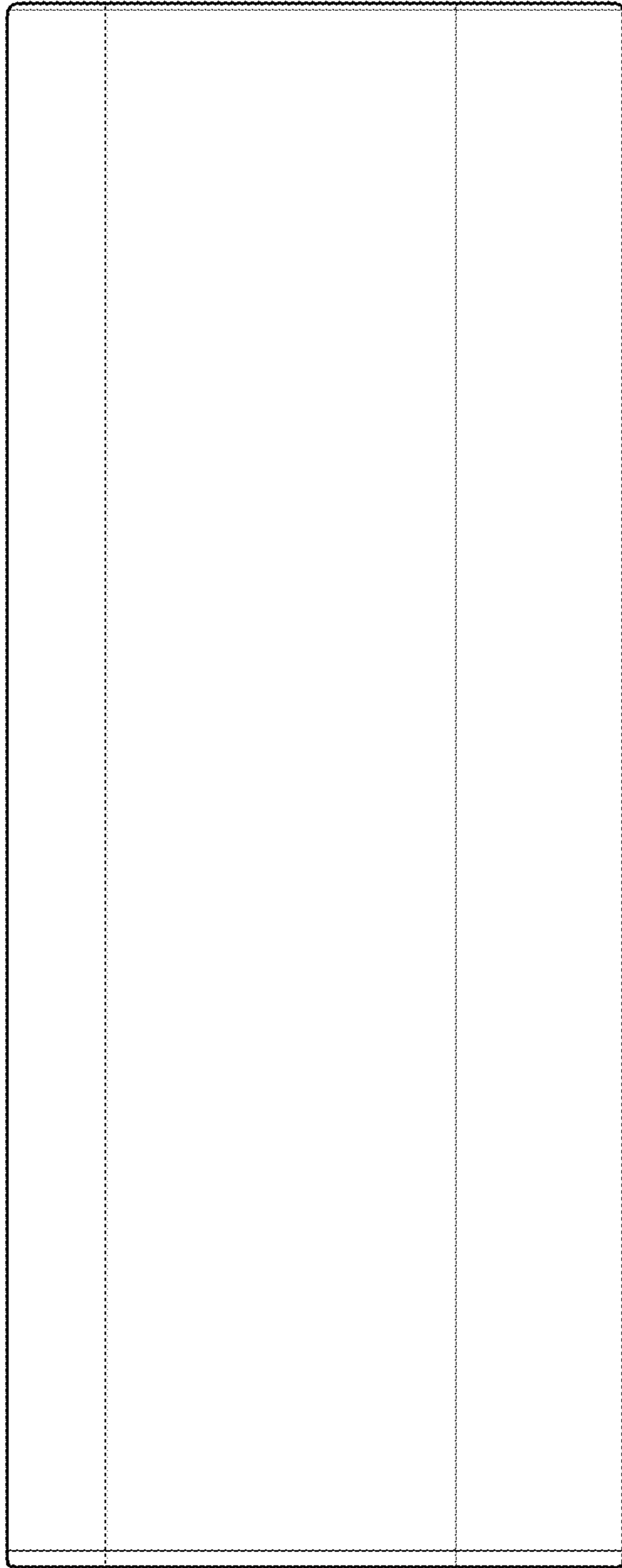

FIG. 9

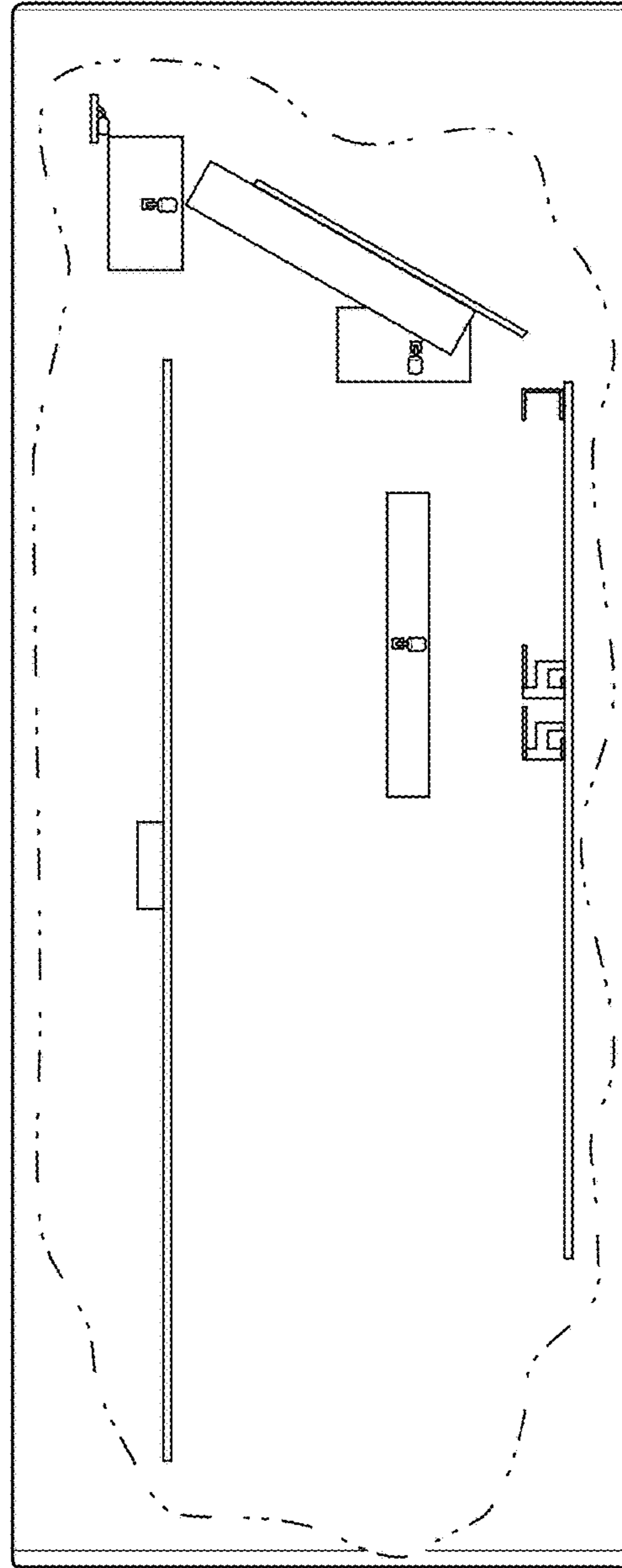

FIG. 9A

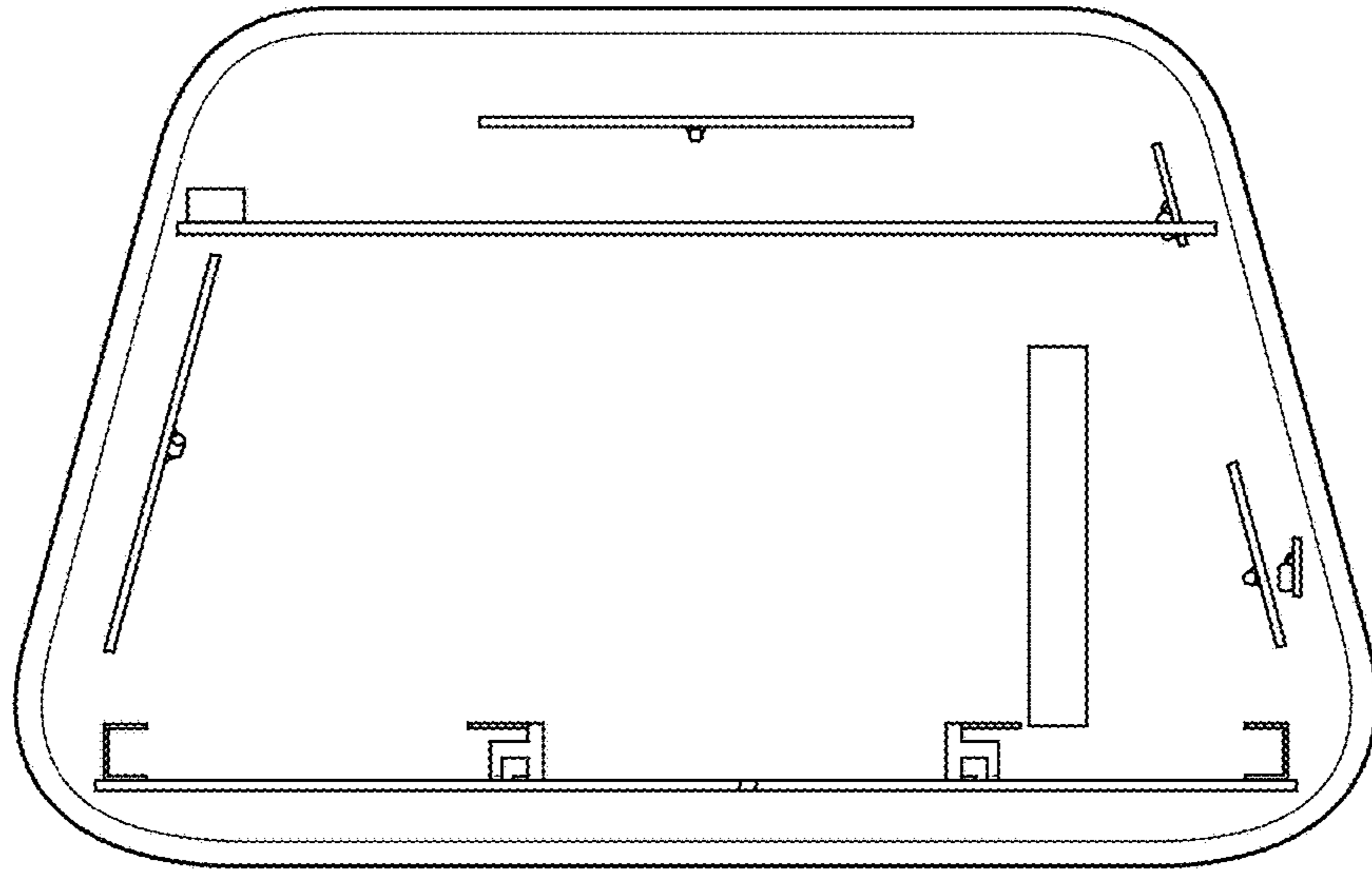

FIG. 10

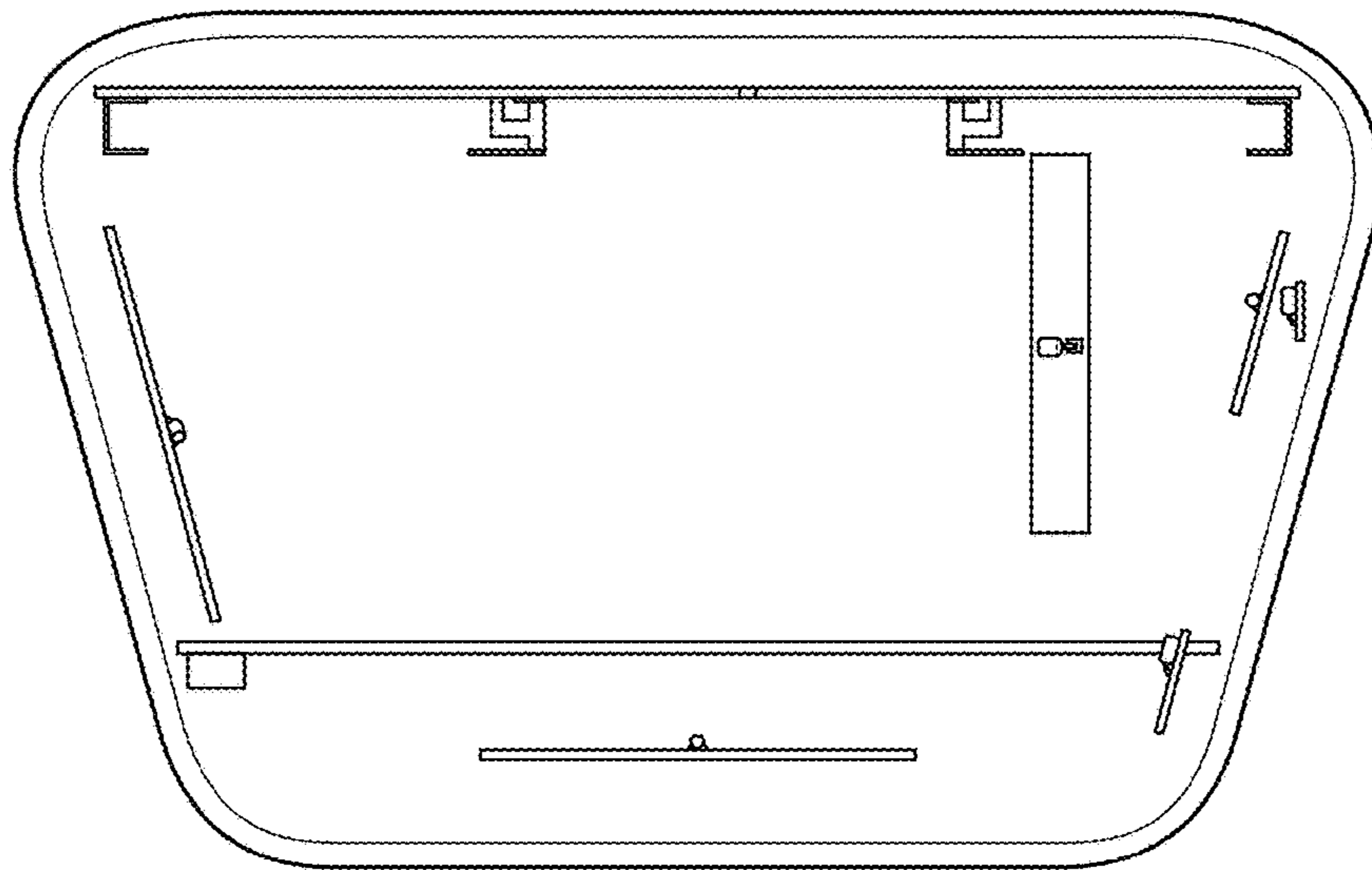

FIG. 11

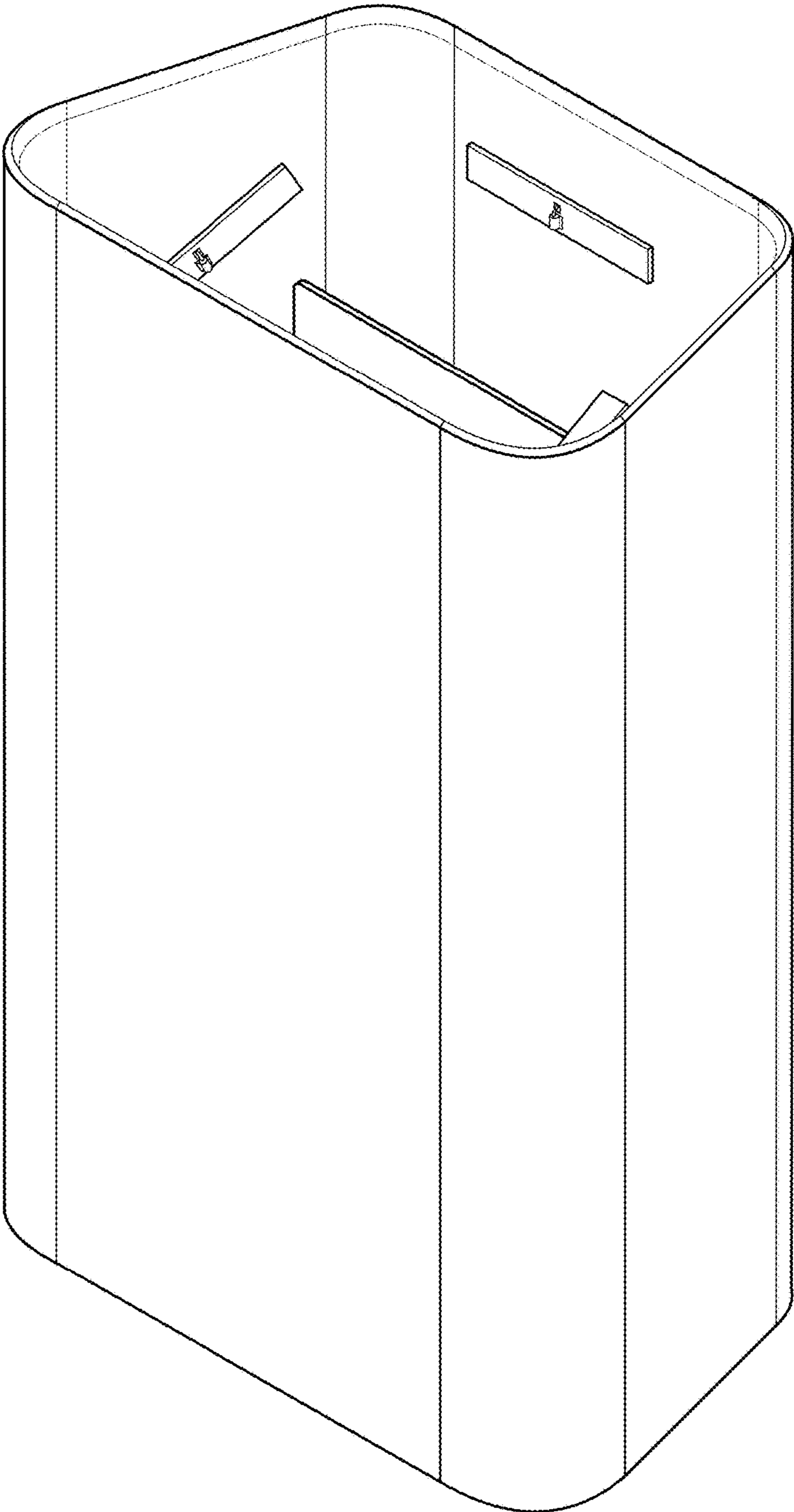

FIG. 12

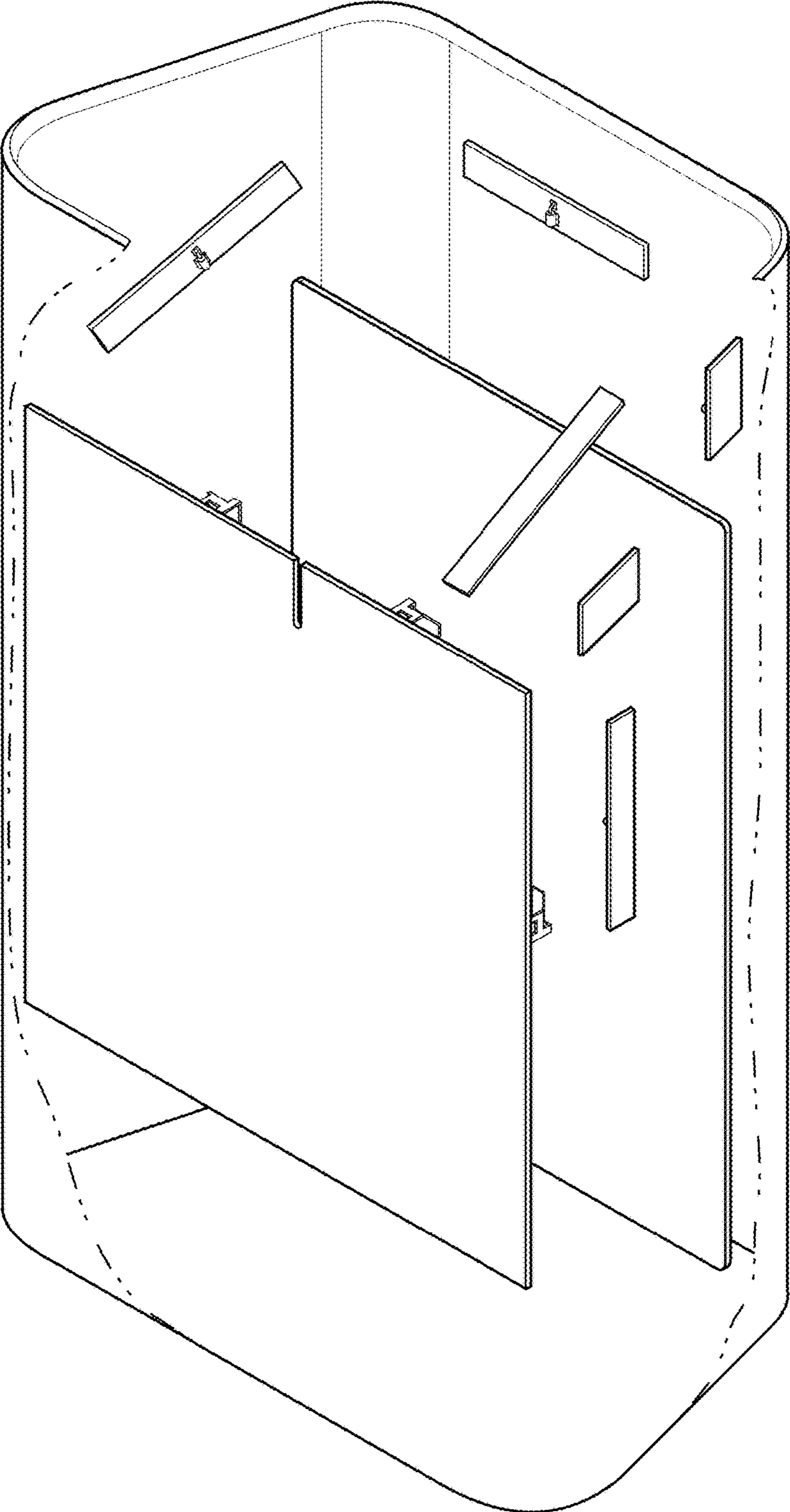

FIG. 12A

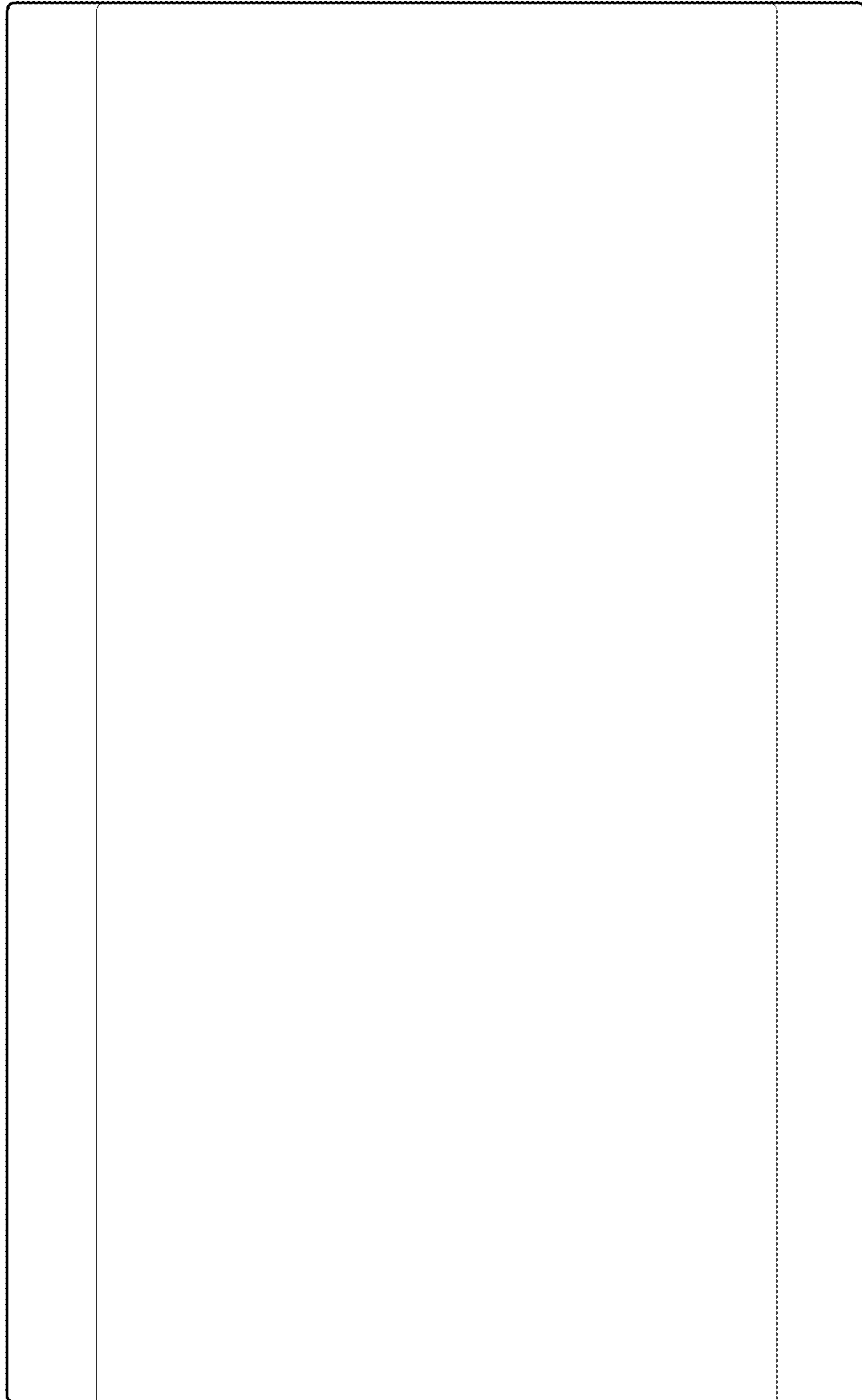

FIG. 13

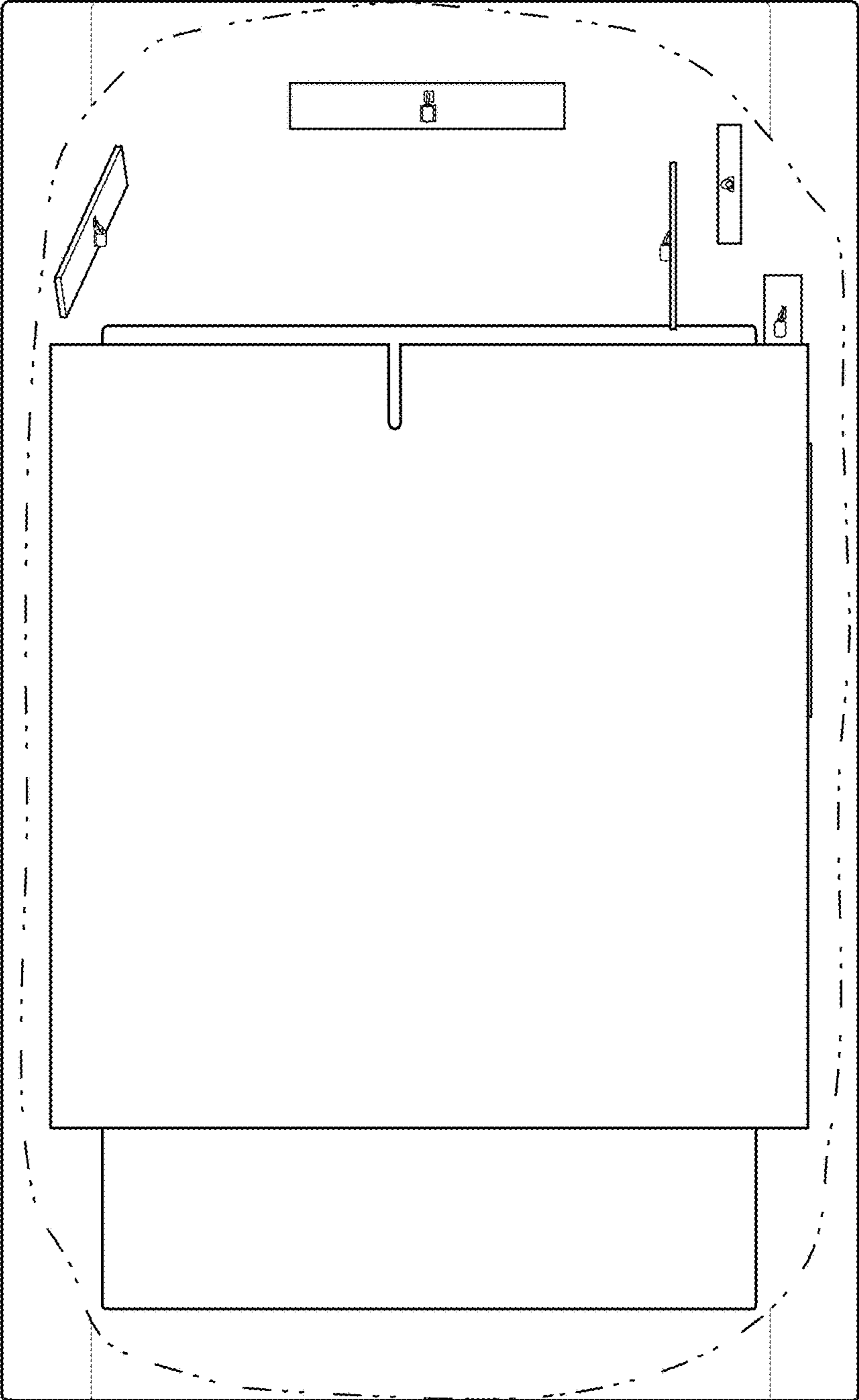

FIG. 13A

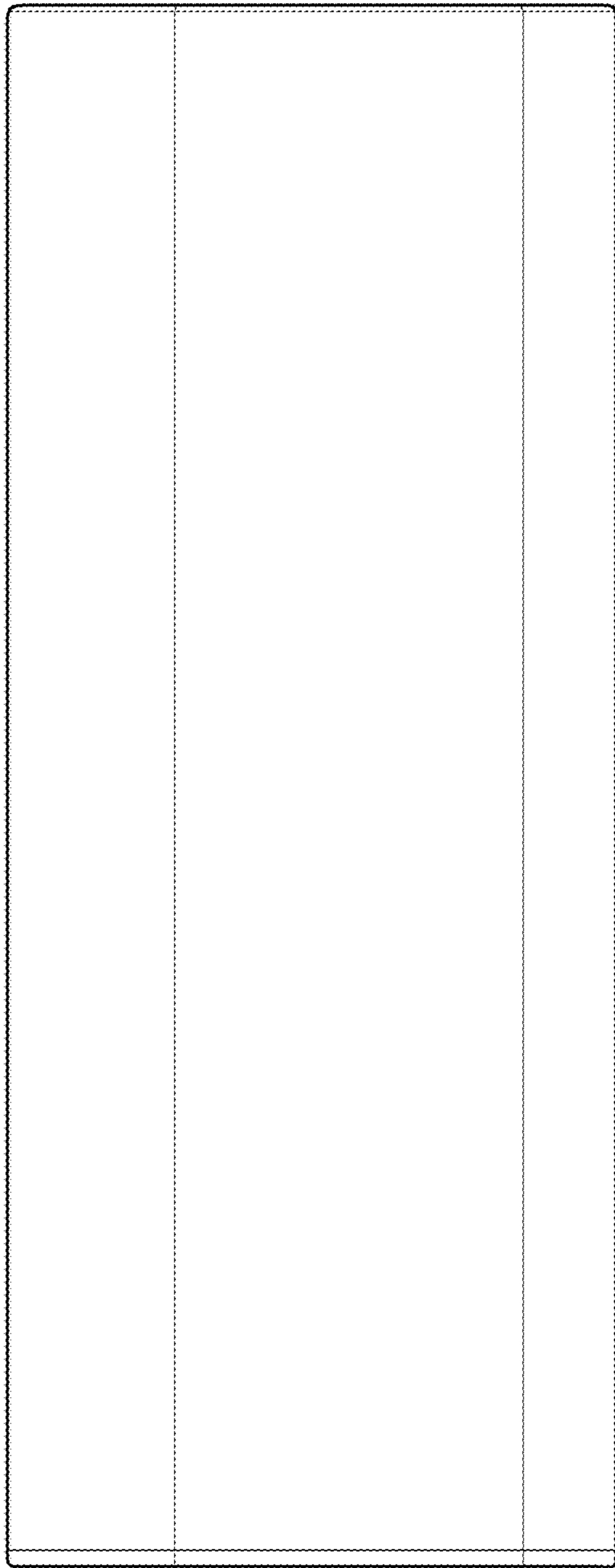

FIG. 14

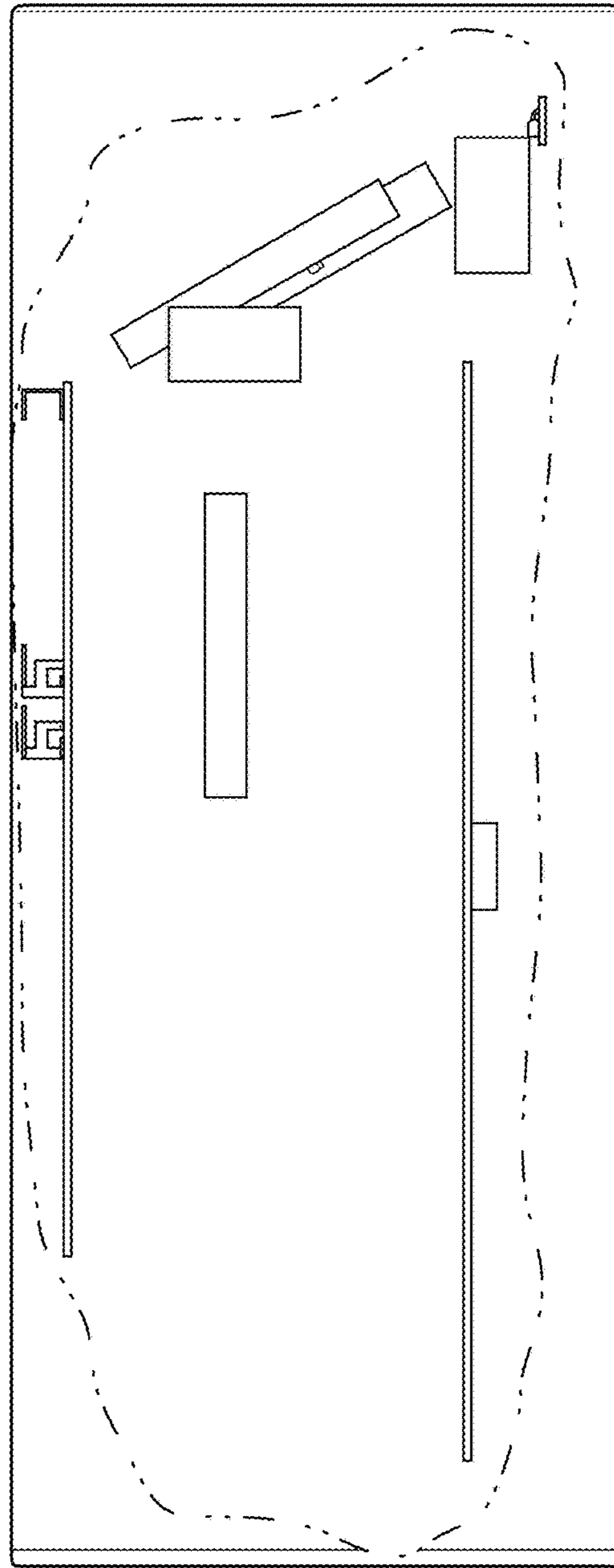

FIG. 14A

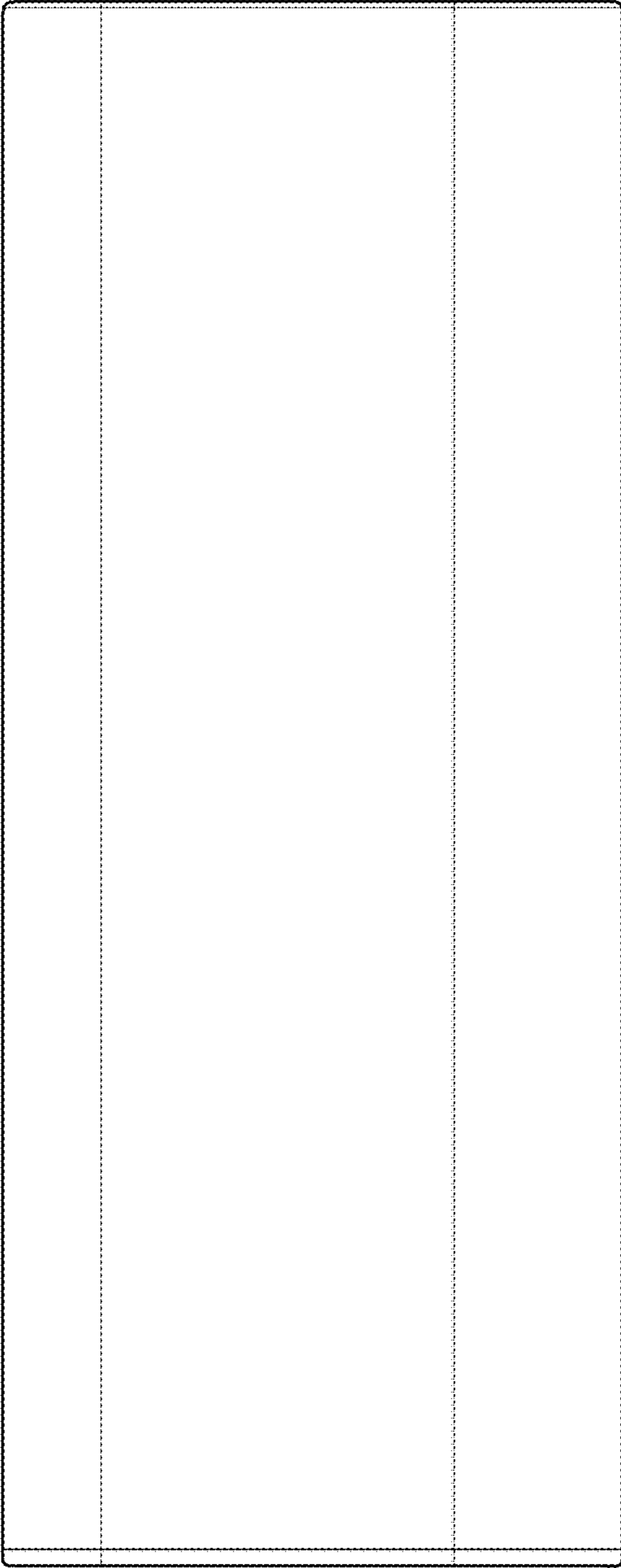

FIG. 15

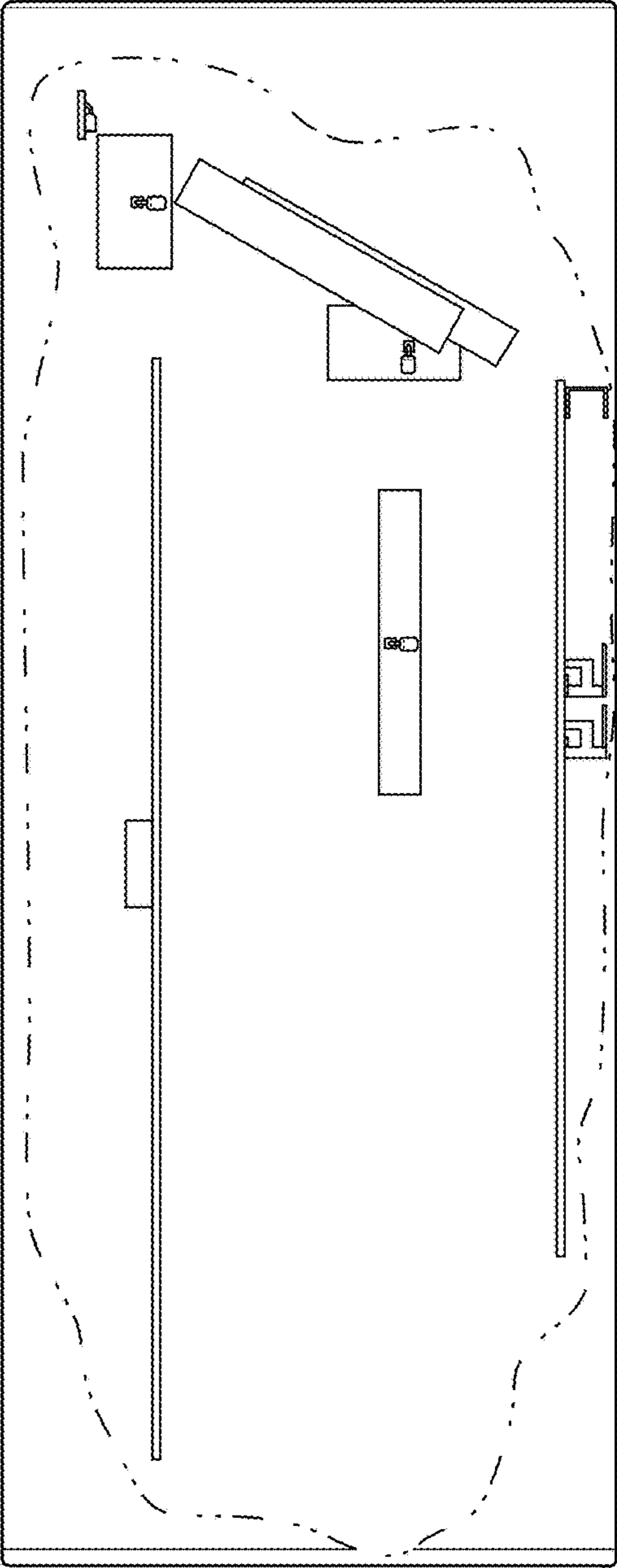

FIG. 15A

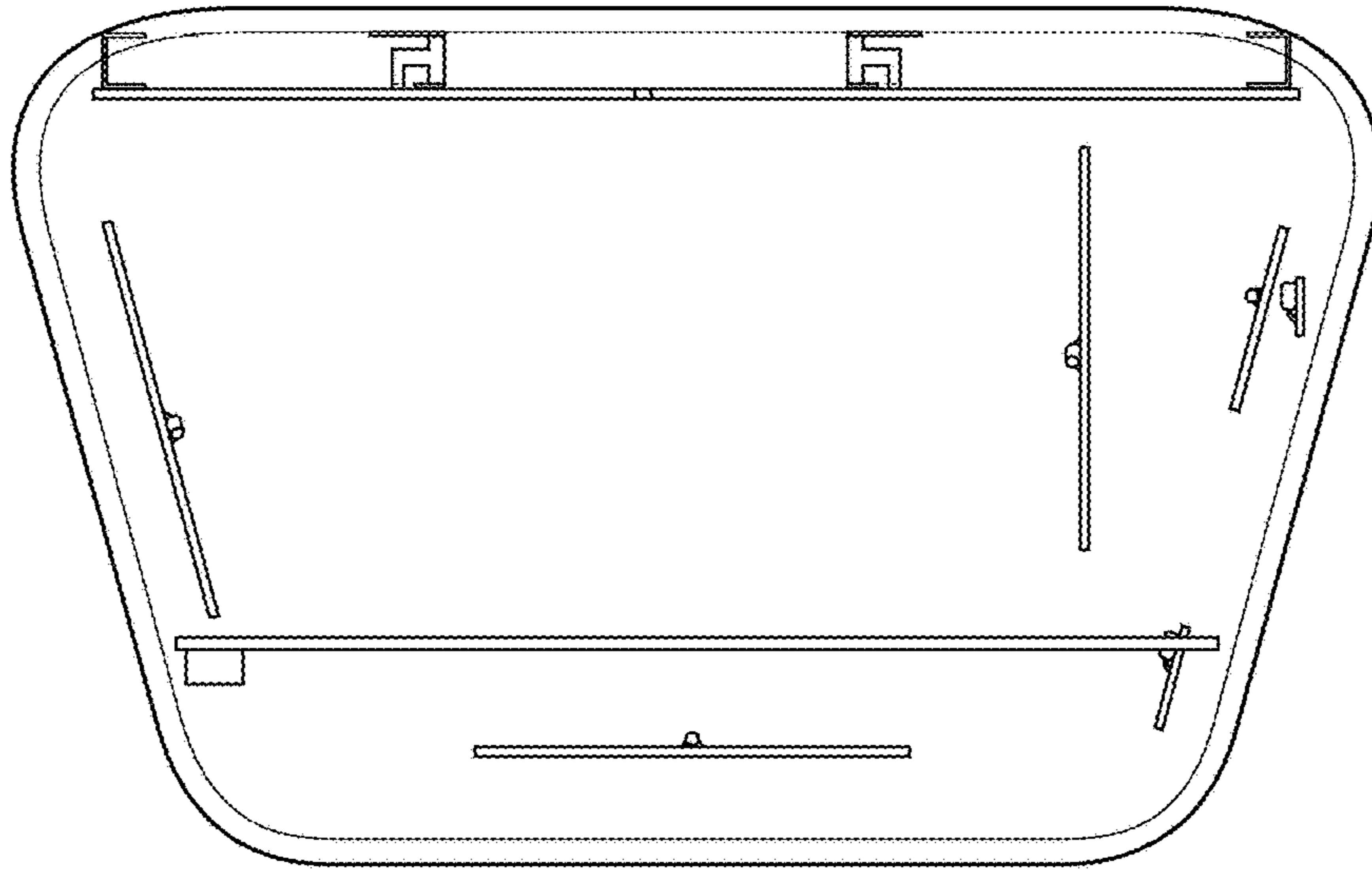

FIG. 16

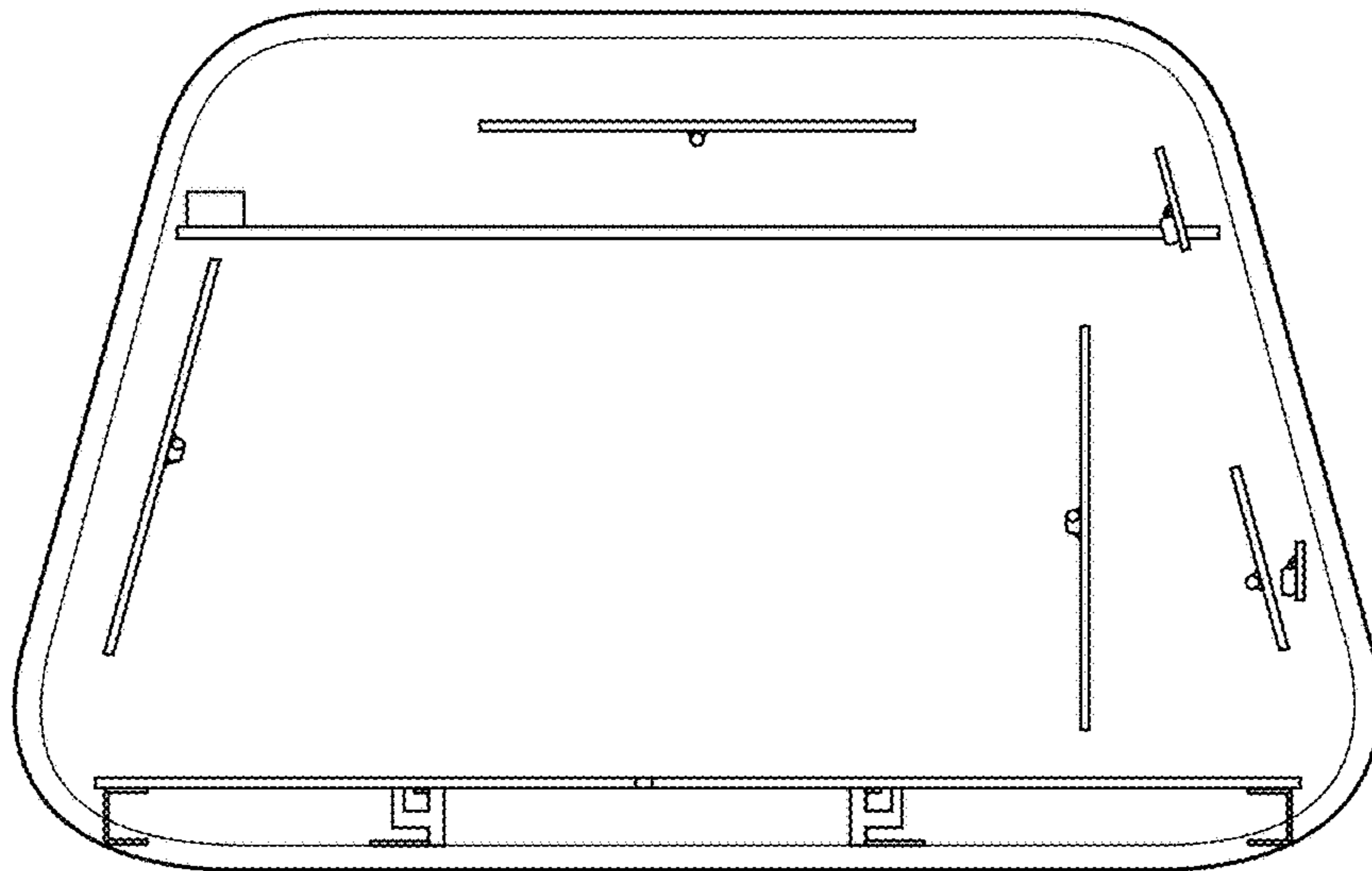

FIG. 17

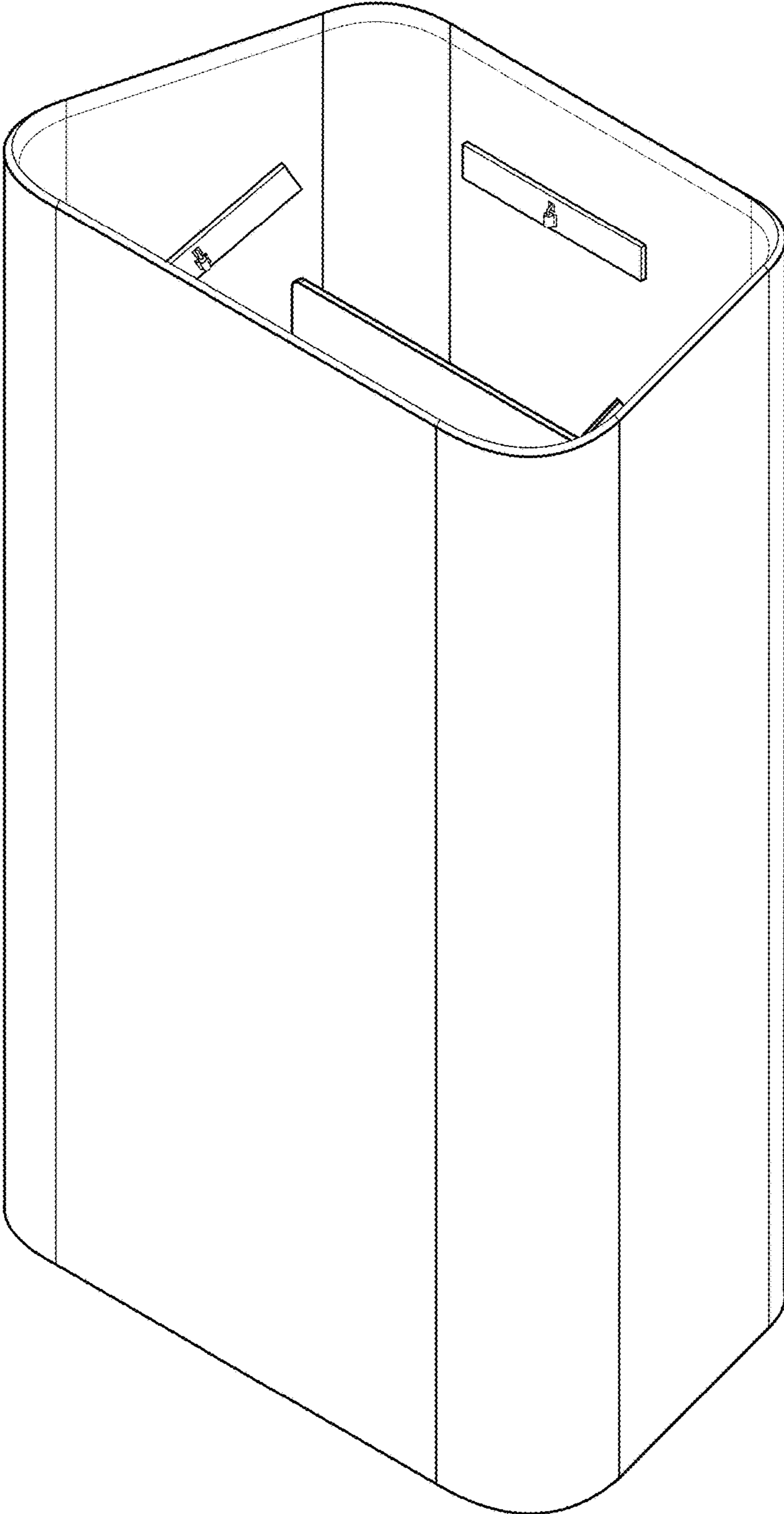

FIG. 18

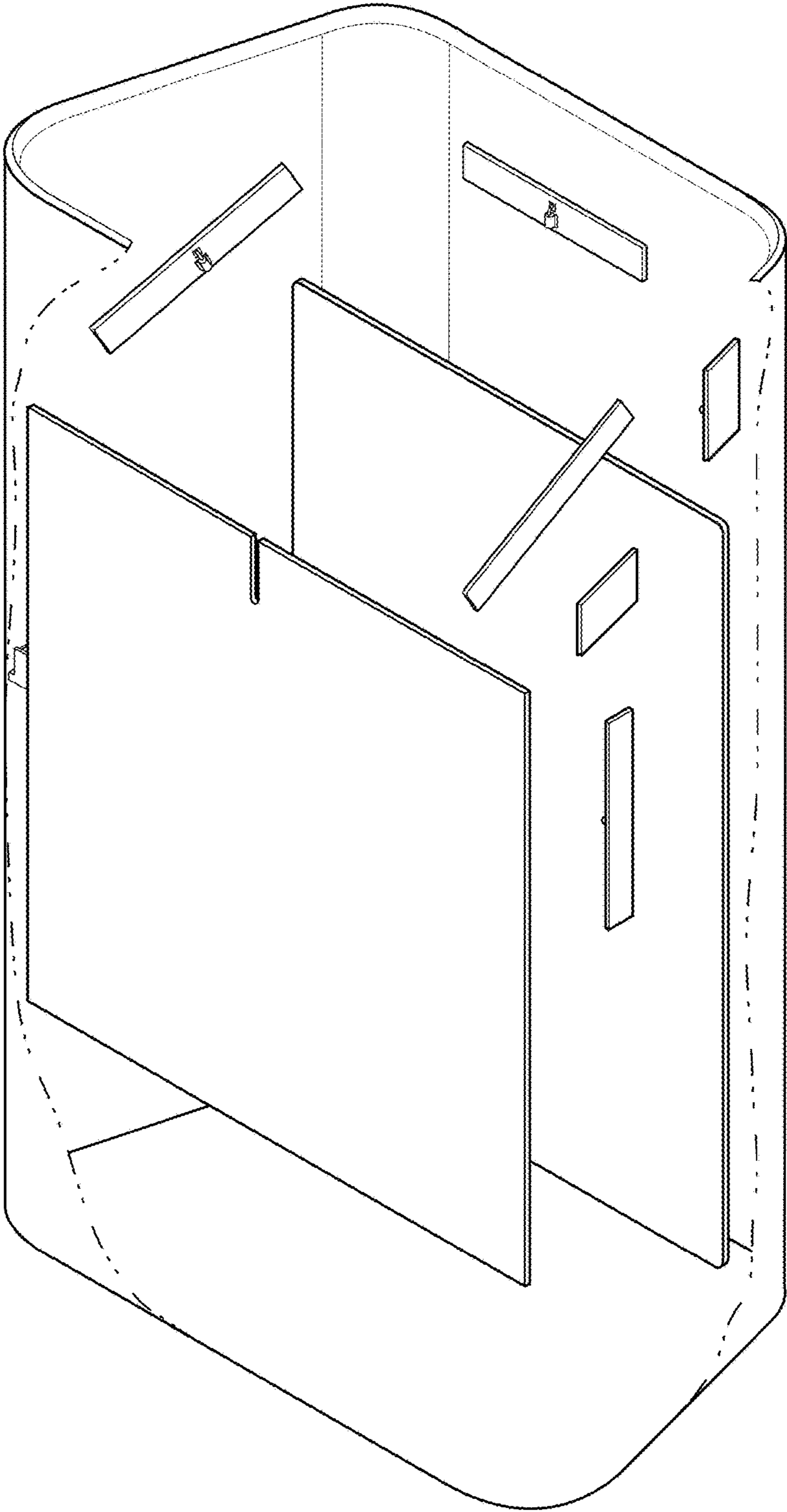

FIG. 18A

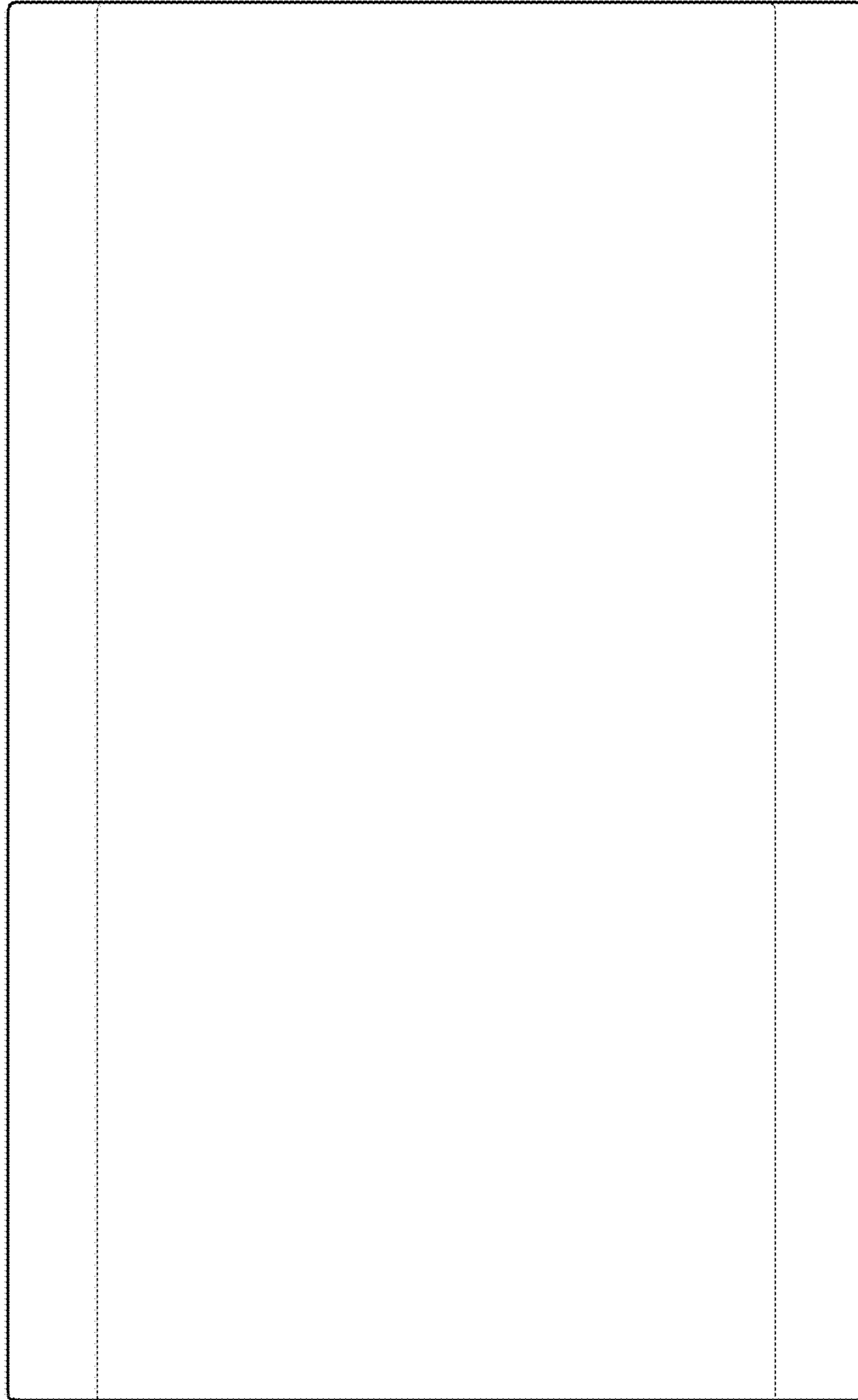

FIG. 19

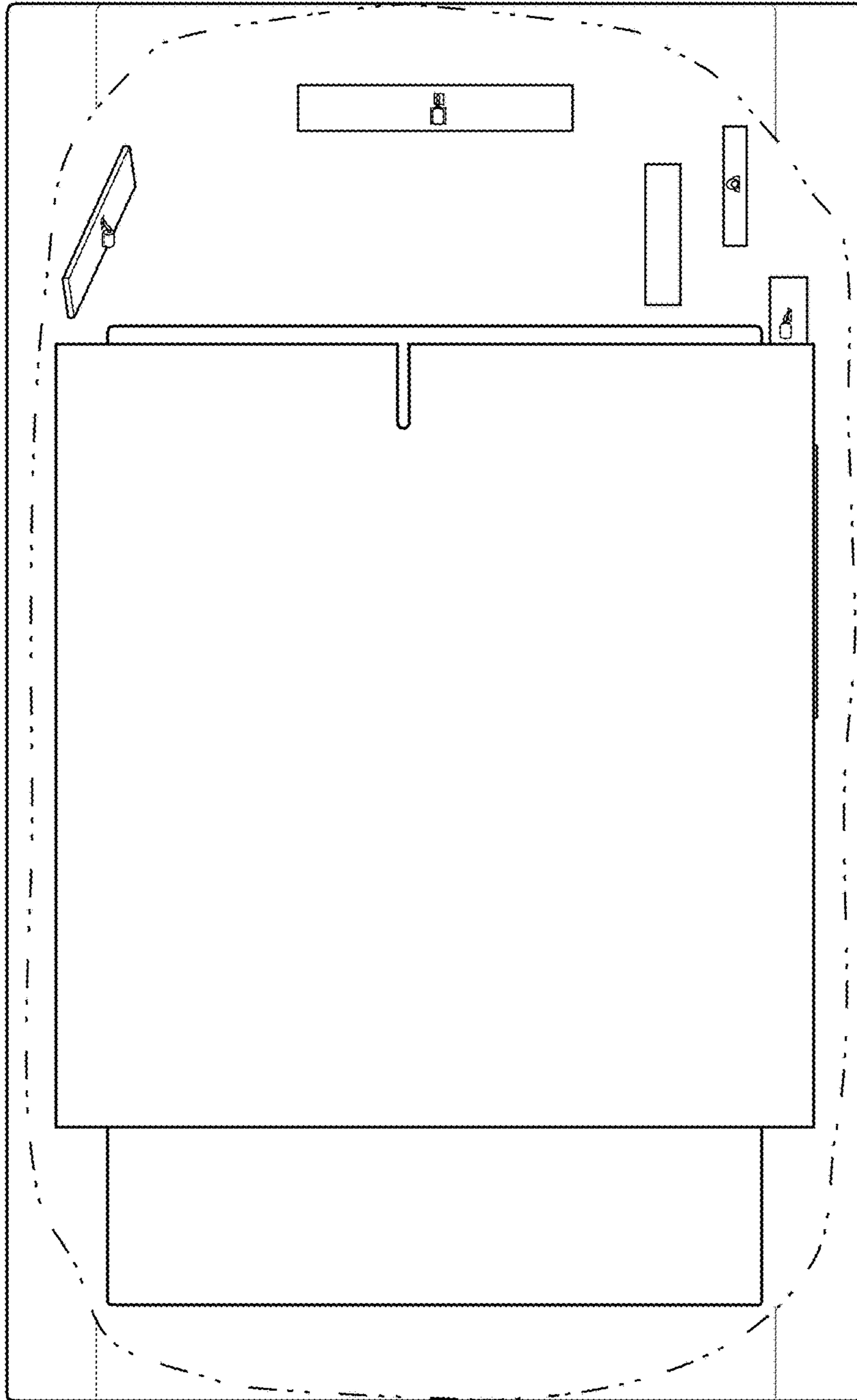

FIG. 19A

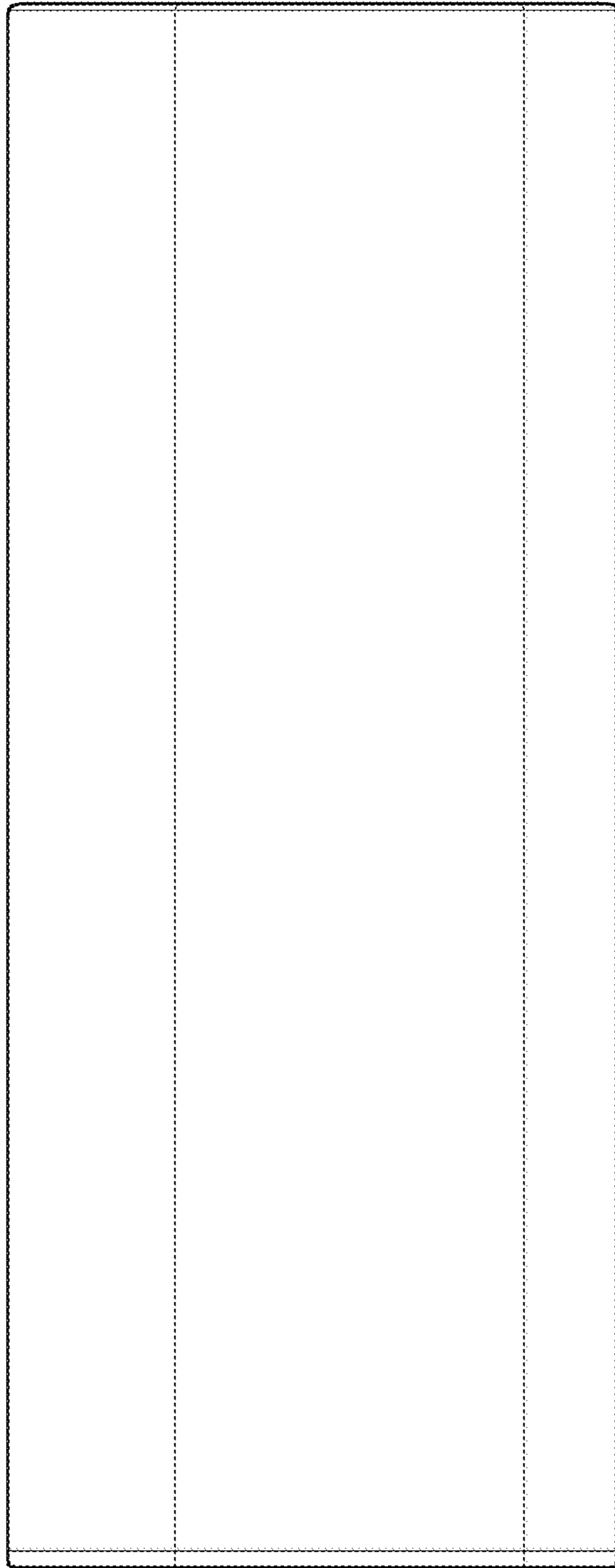

FIG. 20

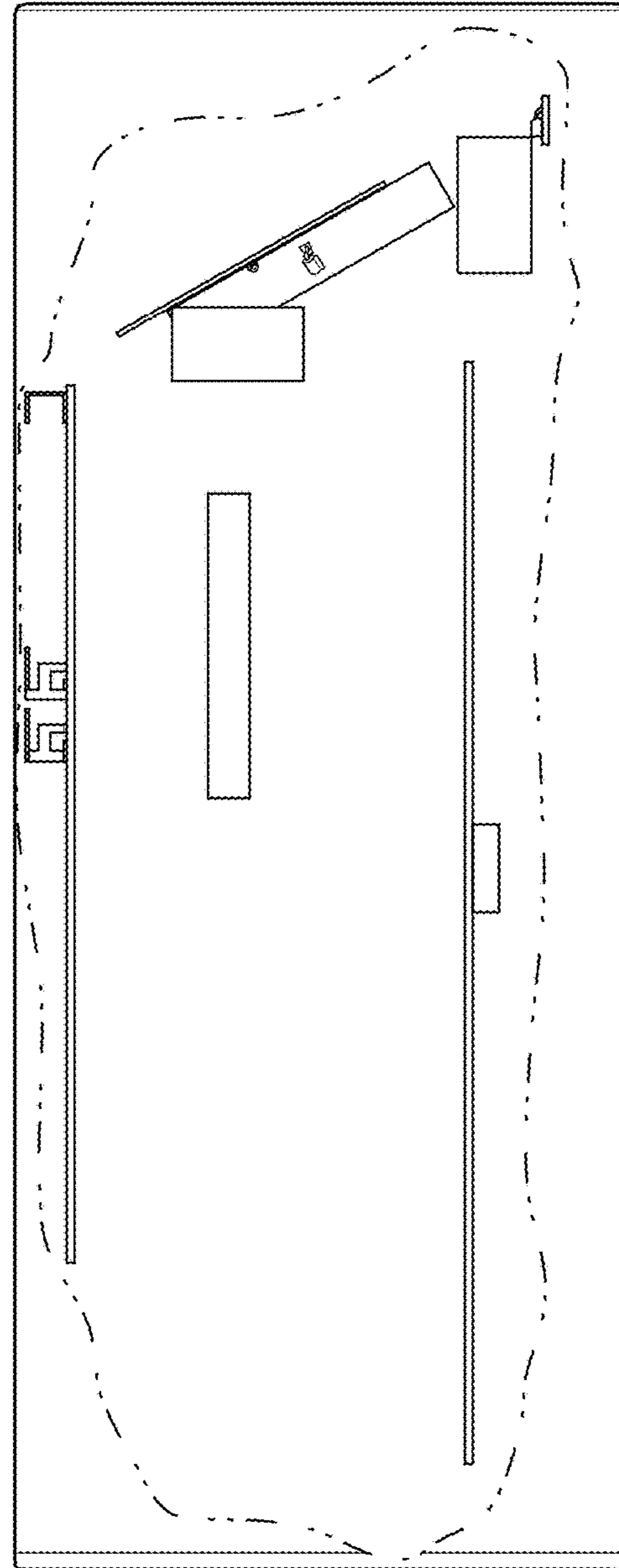

FIG. 20A

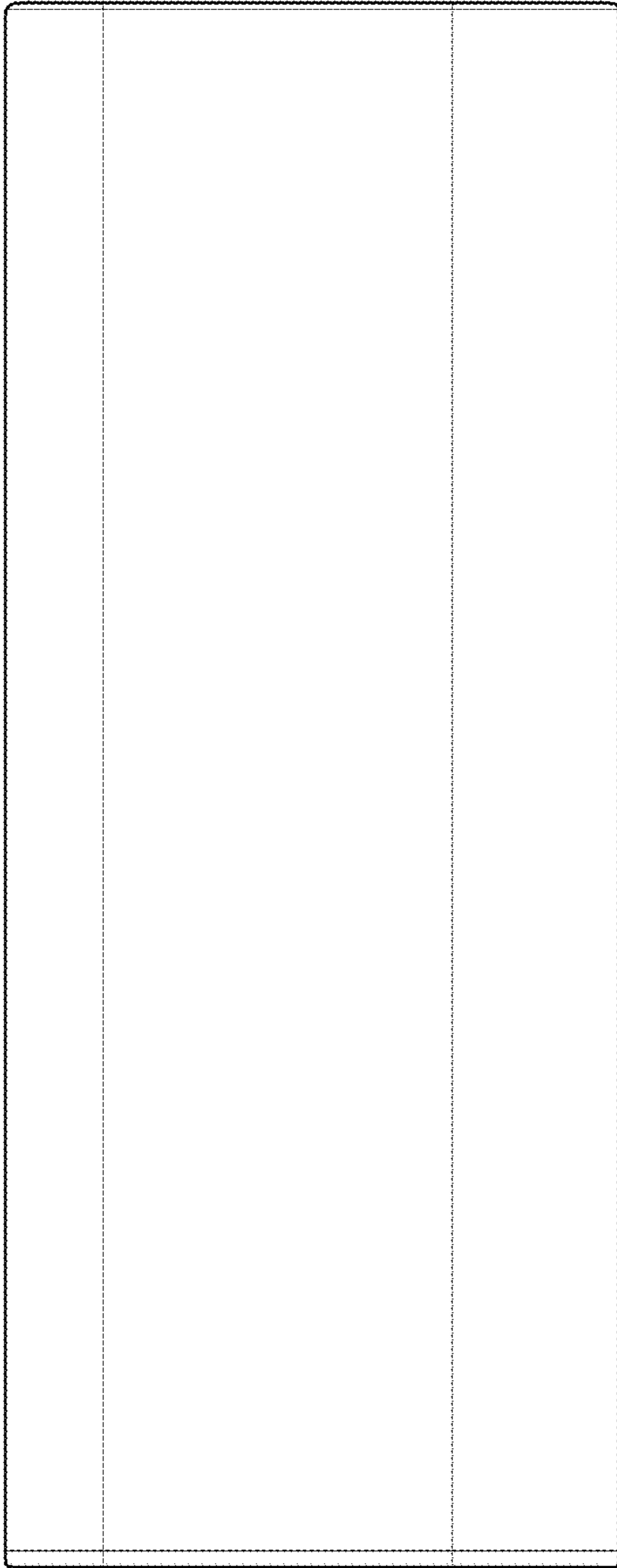

FIG. 21

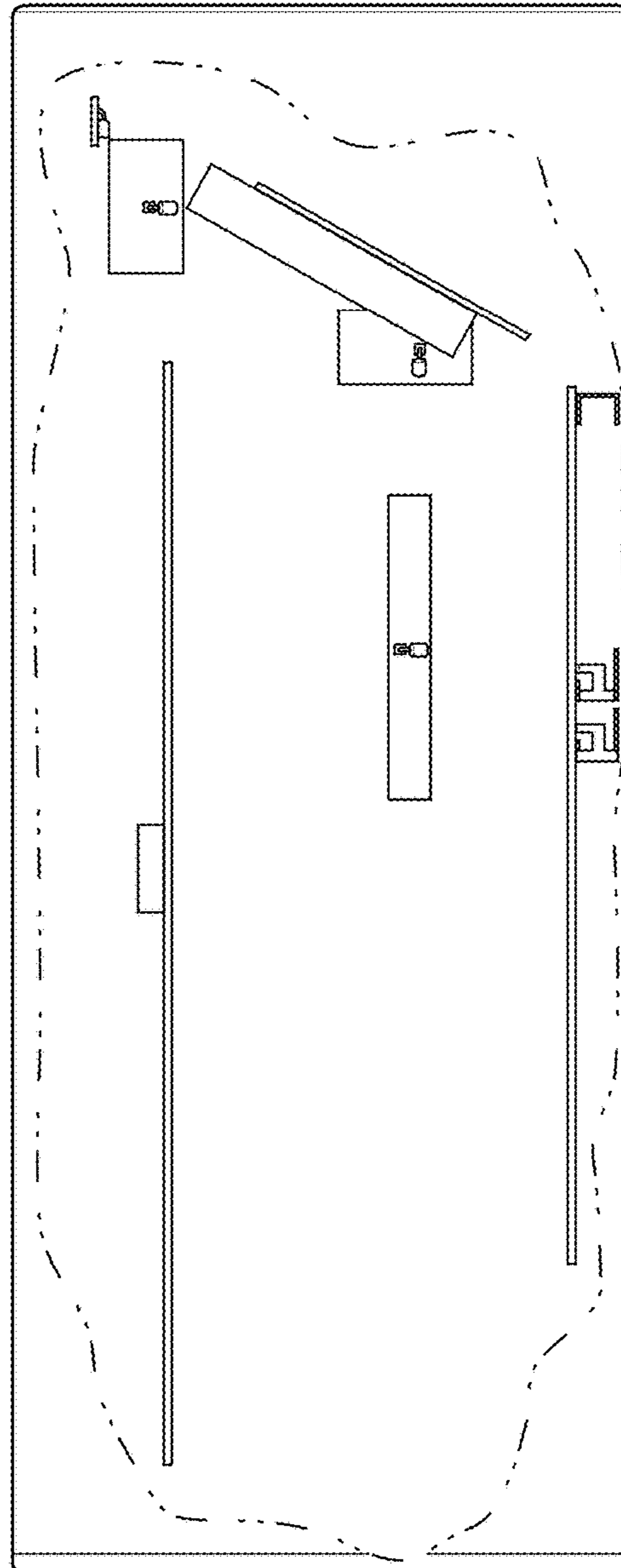

FIG. 21A

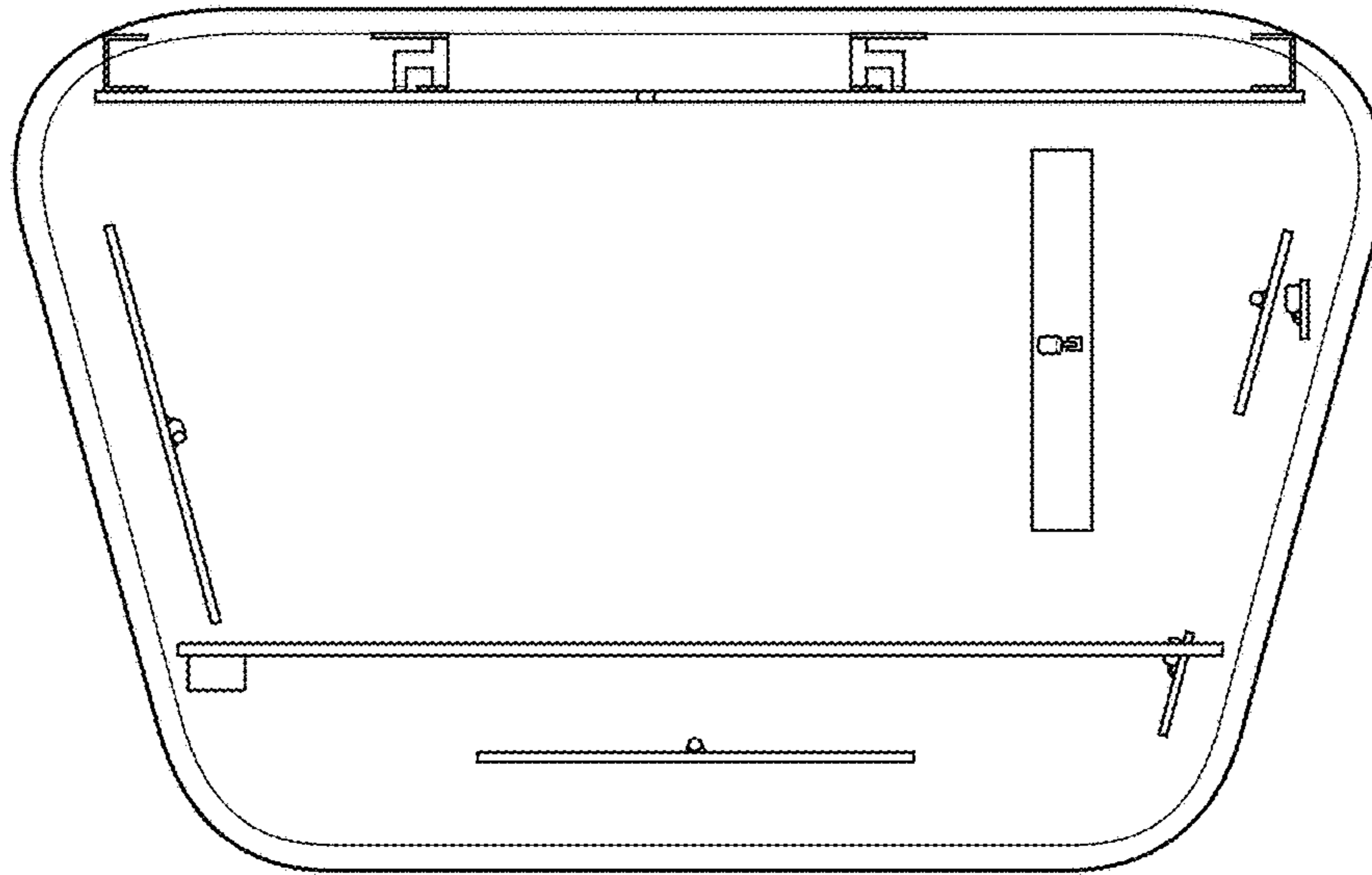

FIG. 22

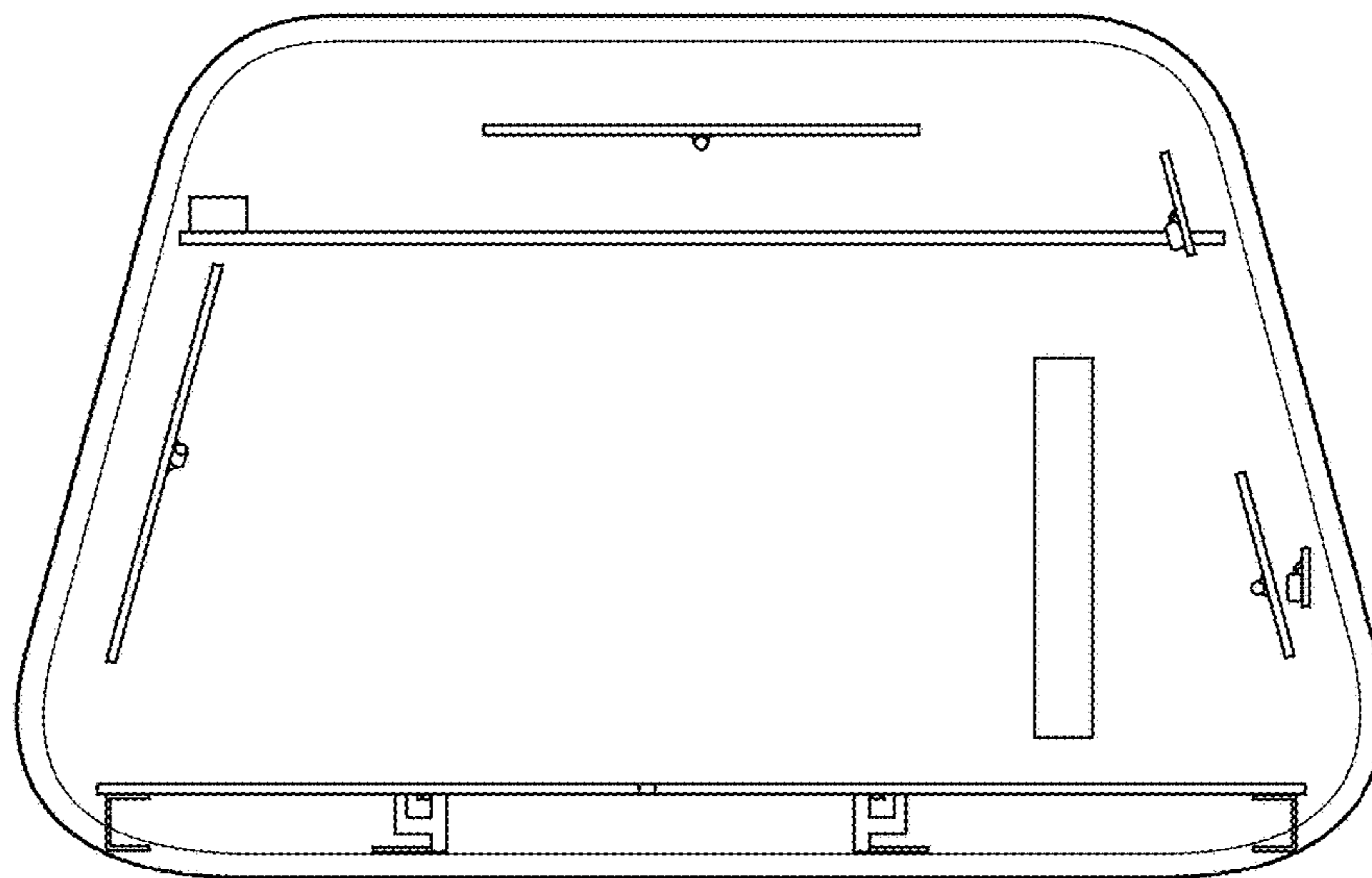

FIG. 23

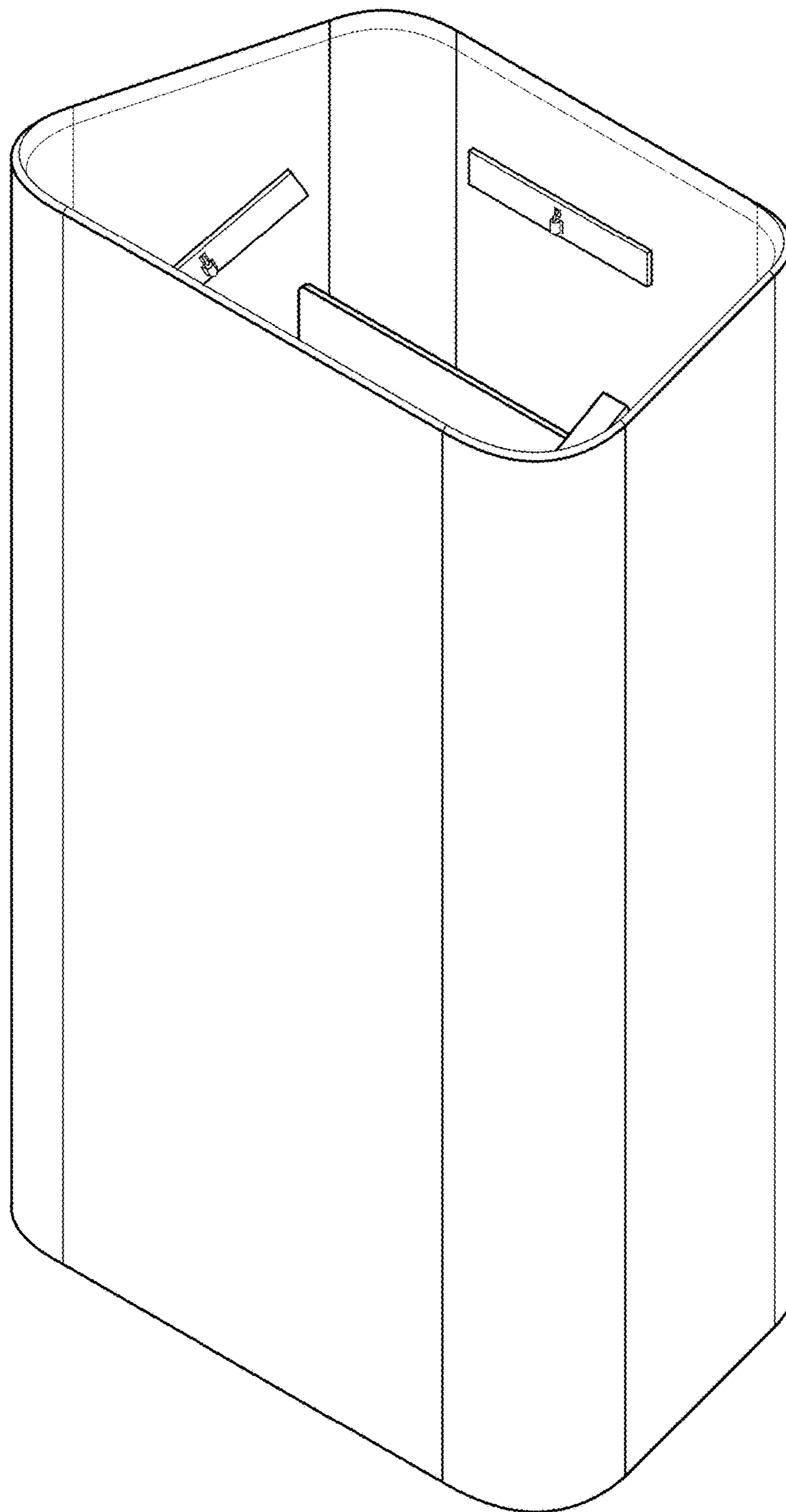

FIG. 24

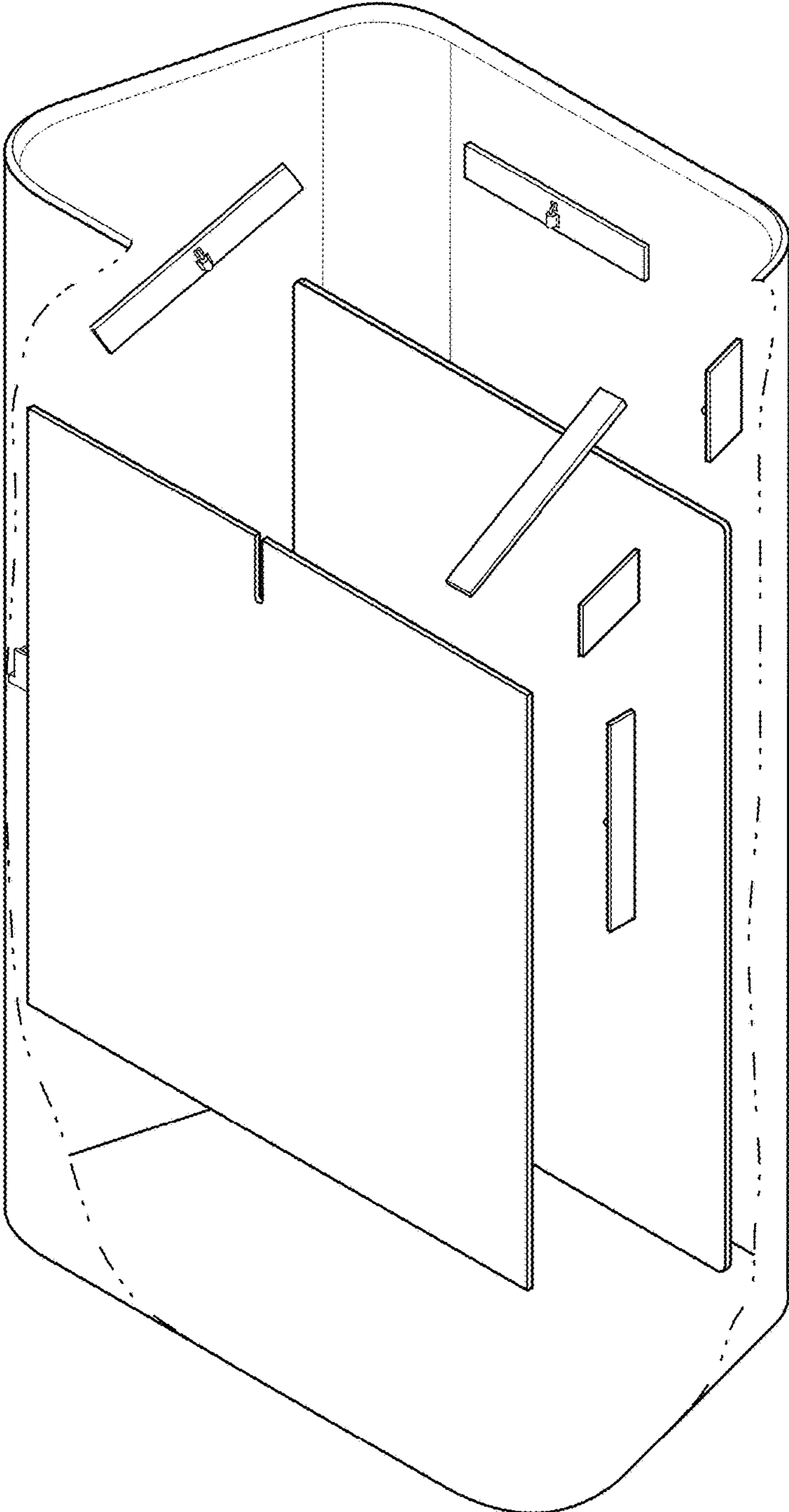

FIG. 24A