



US00D832807S

(12) **United States Design Patent** (10) **Patent No.:** **US D832,807 S**
Xu et al. (45) **Date of Patent:** **** Nov. 6, 2018**

(54) **MOBILE TERMINAL**

(71) Applicant: **ZTE CORPORATION**, Guangdong (CN)

(72) Inventors: **Wen Xu**, Guangdong (CN); **Yuqi Song**, Guangdong (CN)

(73) Assignee: **ZTE Corporation**, Shenzhen, Guangdong (CN)

(**) Term: **15 Years**

(21) Appl. No.: **35/503,756**

(22) Filed: **May 16, 2017**

(80) **Hague Agreement Data**

Int. Filing Date: **May 16, 2017**

Int. Reg. No.: **DM/097801**

Int. Reg. Date: **May 16, 2017**

Int. Reg. Pub. Date: **Oct. 6, 2017**

(30) **Foreign Application Priority Data**

Nov. 21, 2016 (CN) 2016 3 0564422

(51) **LOC (11) Cl.** **14-03**

(52) **U.S. Cl.**
USPC **D14/138 G; D14/341**

(58) **Field of Classification Search**

USPC D14/138 G, 138 AD, 248, 138 R,
D14/138 AC, 247, 137, 341-347

CPC H04M 1/0202; H04M 1/0235; H04M
1/0237; H04M 1/0239; H04M 1/0266;
H04M 1/0268; H04M 1/027; H04M
1/0295

See application file for complete search history.

(56) **References Cited**

U.S. PATENT DOCUMENTS

D782,435 S * 3/2017 Yuan D14/138 AA

D784,946 S * 4/2017 Jun D14/138 AA

D791,730 S * 7/2017 Li D14/138 G
D792,366 S * 7/2017 Zhang D14/138 G
D793,981 S * 8/2017 Seo D14/138 G
D795,213 S * 8/2017 Kim D14/138 G
D795,827 S * 8/2017 Seo D14/138 G
D795,829 S * 8/2017 Seo D14/138 G
D797,071 S * 9/2017 Seo D14/138 G
D797,697 S * 9/2017 Lee D14/138 G
D798,260 S * 9/2017 Seo D14/138 G
D810,715 S * 2/2018 Cho D14/138 G
D812,585 S * 3/2018 Song D14/138 G
D812,586 S * 3/2018 Zhu D14/138 G
D813,854 S * 3/2018 Lee D14/248
D816,633 S * 5/2018 Lee D14/138 G
D817,912 S * 5/2018 Choi D14/138 G
D817,950 S * 5/2018 Lee D14/341
D818,982 S * 5/2018 Cho D14/138 G
D819,019 S * 5/2018 Zhang D14/341
D820,232 S * 6/2018 Shin D14/138 G
D821,344 S * 6/2018 Park D14/138 G
D821,377 S * 6/2018 Cho D14/248

* cited by examiner

Primary Examiner — Michael A. Pratt

(74) *Attorney, Agent, or Firm* — Oppedahl Patent Law Firm LLC

(57) **CLAIM**

The ornamental design for a mobile terminal, as shown and described.

DESCRIPTION

1. Mobile terminal

1.1 : Front

1.2 : Back

1.3 : Left

1.4 : Right

1.5 : Top

1.6 : Bottom

1.7 : Perspective

1.8 : Perspective

1 Claim, 8 Drawing Sheets

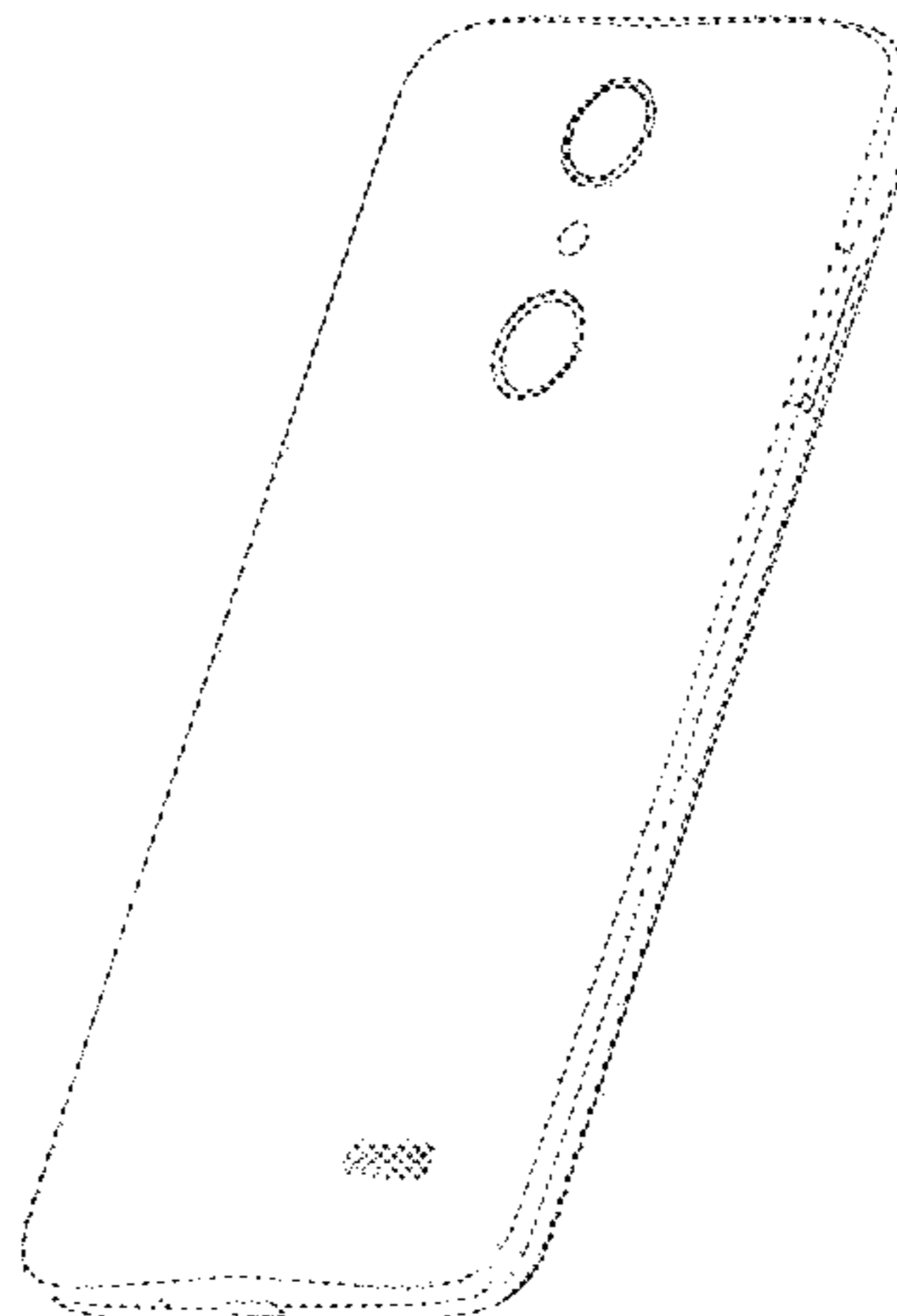
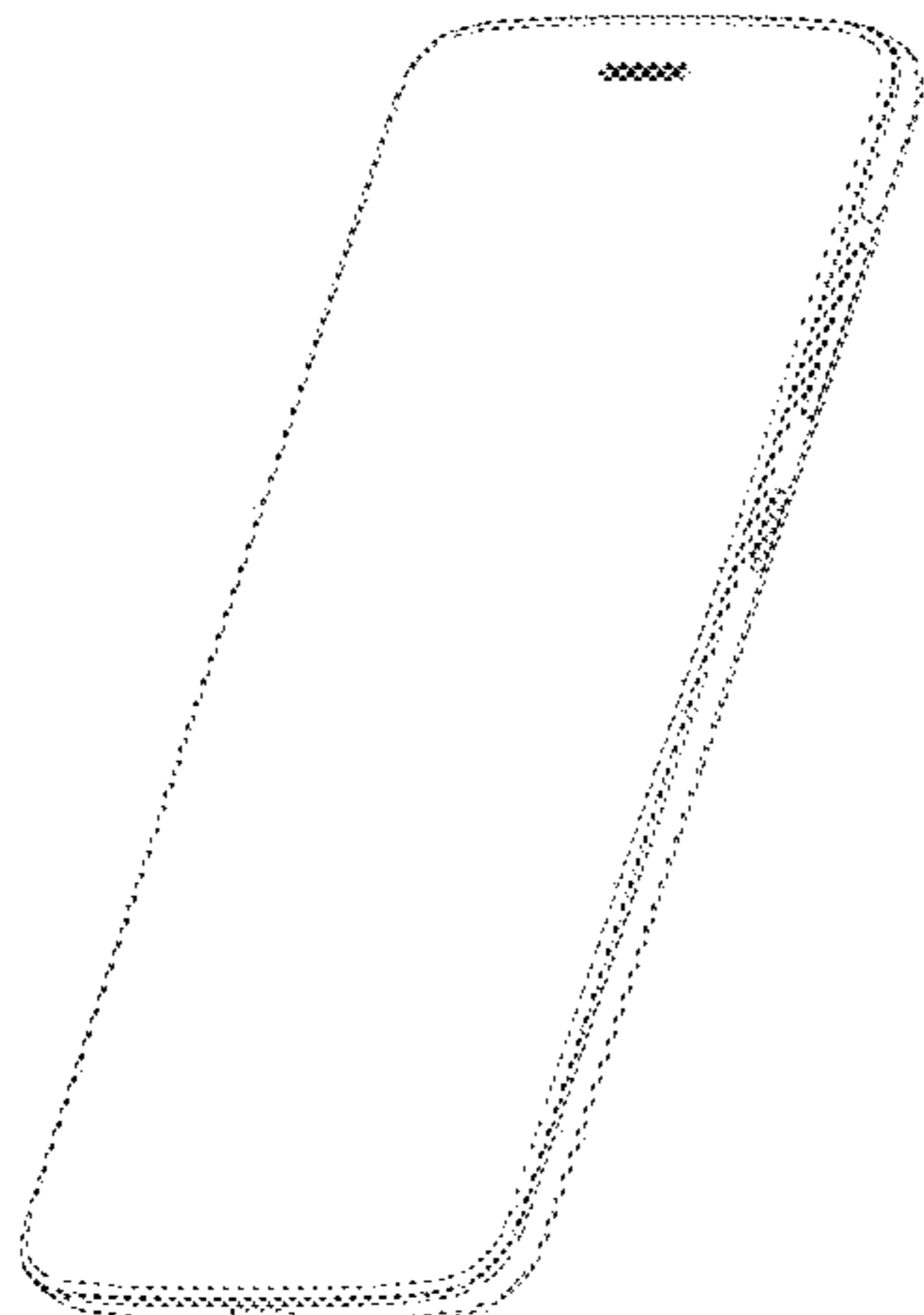

1.1

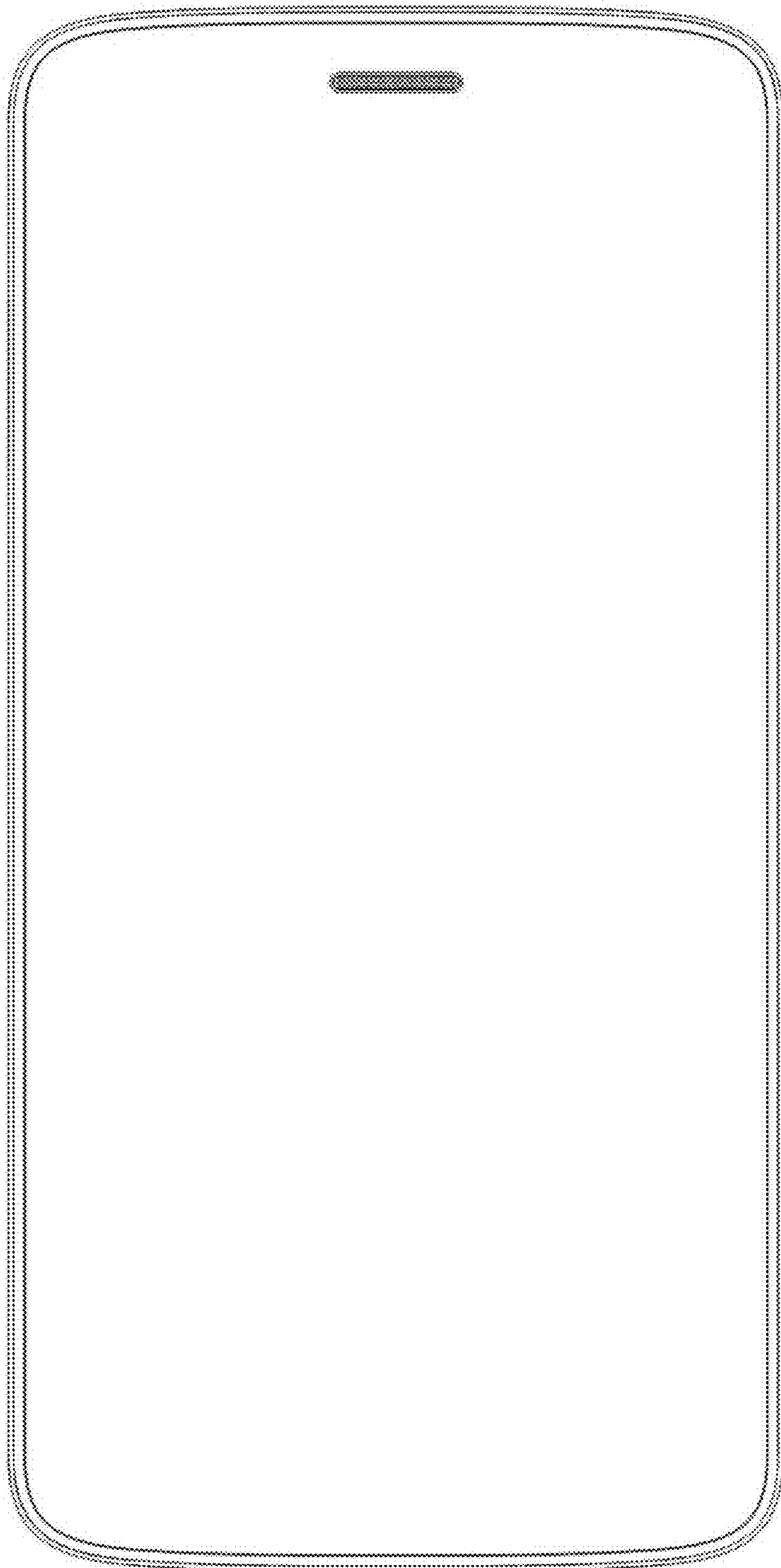

1.2

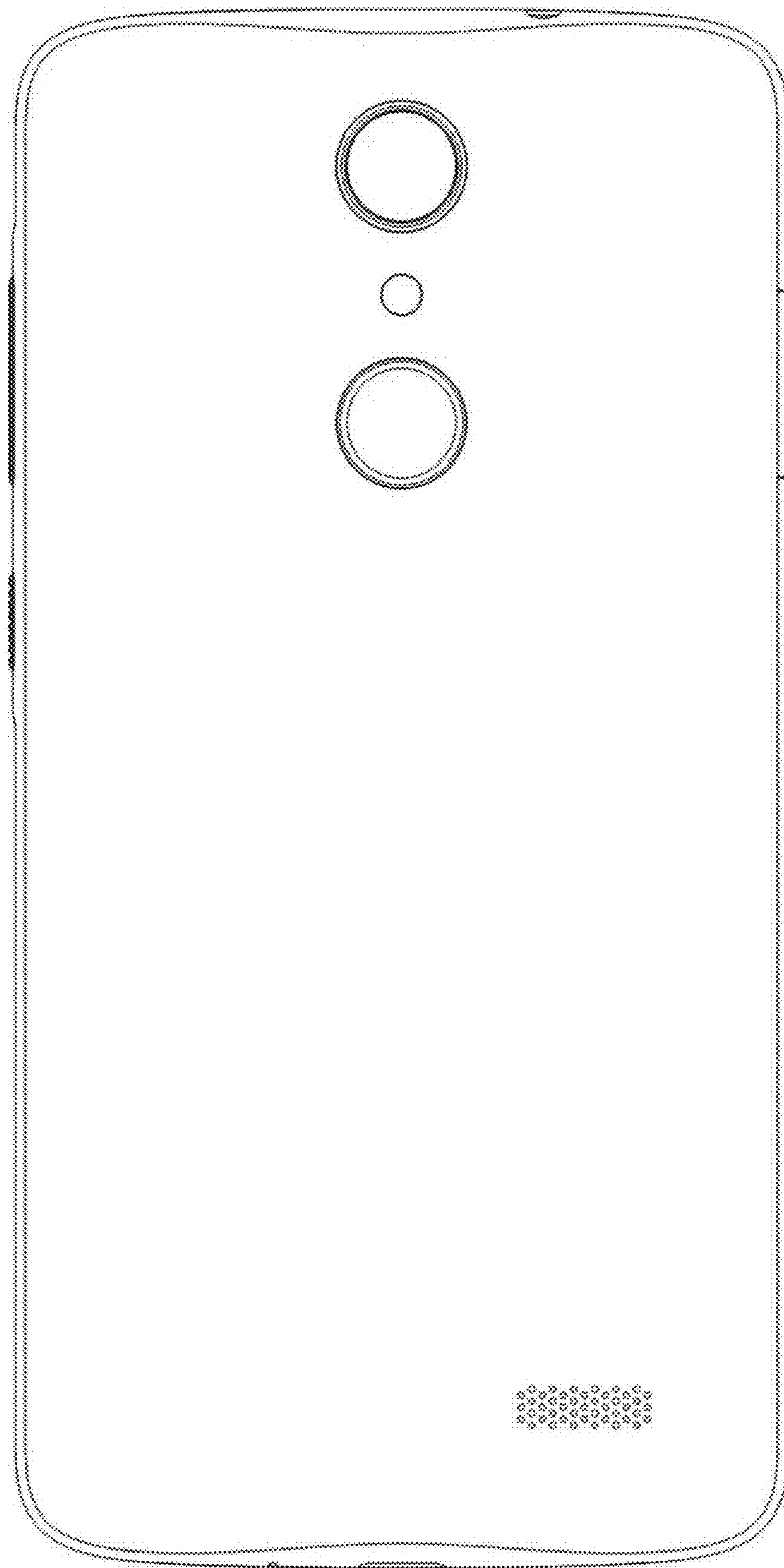

1.3

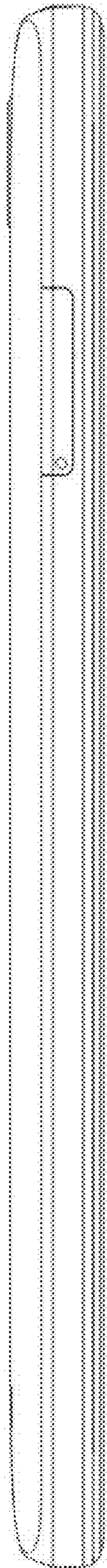

1.4

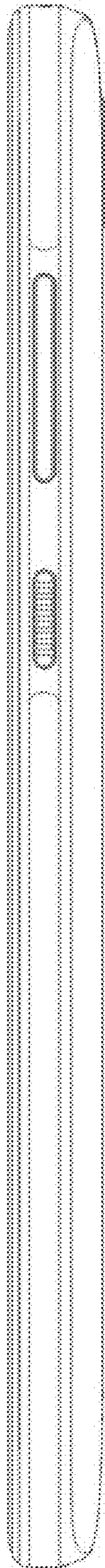

1.5

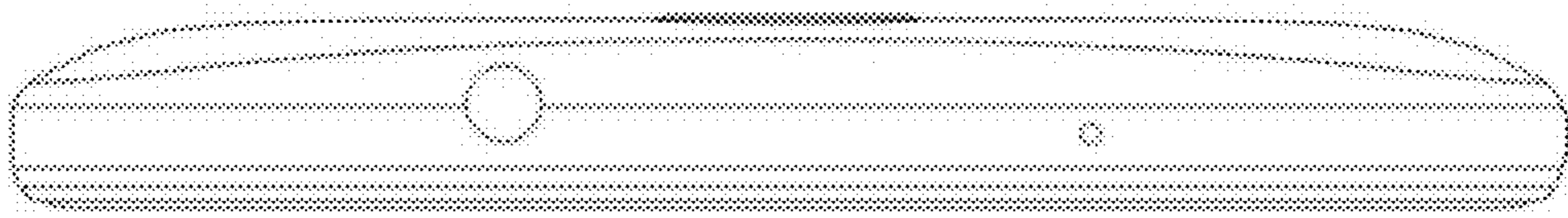

1.6

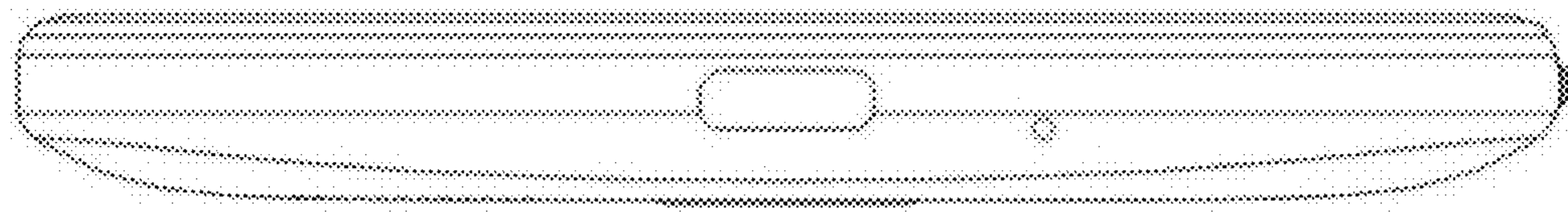

1.7

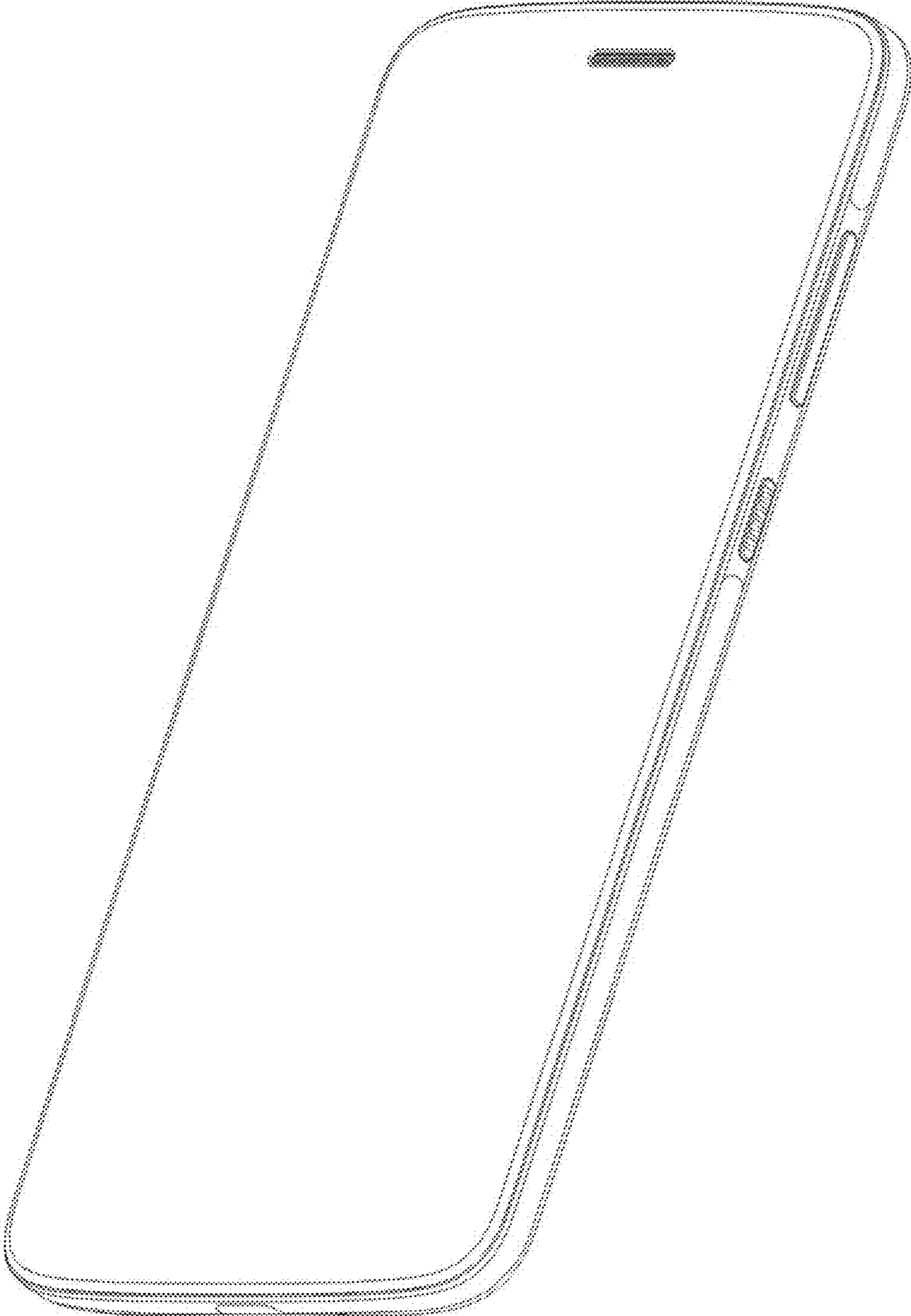

1.8

