



US00D832719S

(12) **United States Design Patent** (10) **Patent No.:** **US D832,719 S**
Moynihan (45) **Date of Patent:** **** Nov. 6, 2018**

(54) **FLUID CONTAINER AND DISPENSER**

(71) Applicant: **Dave E. Moynihan**, Penfield, NY (US)

(72) Inventor: **Dave E. Moynihan**, Penfield, NY (US)

(**) Term: **15 Years**

(21) Appl. No.: **29/612,786**

(22) Filed: **Aug. 3, 2017**

(51) **LOC (11) Cl.** **09-05**

(52) **U.S. Cl.**
USPC **D9/707**

(58) **Field of Classification Search**
USPC D9/702-714, 429-432, 447, 720, 414,
D9/571-575, 682, 738-747, 516-517,
D9/529-530, 547-549, 569, 537-538,
D9/544, 503-505, 545; 383/6, 9, 22, 96,
383/61.1, 80-81, 104, 901, 63, 203, 107,
383/119, 120, 123; D24/118, 207;
222/92, 107, 206; 604/316, 403, 410,
604/408; 220/495.03, 669, 575;
215/381-385, 12.1; D3/202, 303, 232,
D3/244

CPC B65D 1/00; B65D 1/0223; B65D 1/24;
B65D 1/38; B65D 1/02; B65D 11/00;
B65D 11/02; B65D 11/04; B65D 11/10;
B65D 11/14; B65D 11/20; B65D 29/02;
B65D 29/04; B65D 33/00; B65D 33/02;
B65D 41/00; B65D 41/02; B65D 47/00;
B65D 47/02; B65D 47/04; B65D 47/06

See application file for complete search history.

(56) **References Cited**

U.S. PATENT DOCUMENTS

D478,504 S *	8/2003	Crozet	D9/708
D680,446 S *	4/2013	Moynihan	D9/709
D680,880 S *	4/2013	Johnson	D9/709
D699,128 S *	2/2014	Moynihan	D9/707
D701,774 S *	4/2014	Steigelman	D9/703
D711,251 S *	8/2014	Epstein	D9/707
D785,462 S *	5/2017	Contessa	D9/702

* cited by examiner

Primary Examiner — Abraham Bahta

(74) *Attorney, Agent, or Firm* — Theodore J. Bielen, Jr.

(57) **CLAIM**

The ornamental design for a fluid container and dispenser, as shown and described.

DESCRIPTION

FIG. 1 is a top, left side perspective view of a first embodiment of a liquid container and dispenser showing my new design;

FIG. 2 is a front elevational view;

FIG. 3 is a rear elevational view;

FIG. 4 is a top plan view;

FIG. 5 is a left side elevational view, the right side elevational view being a mirror image thereof; and,

FIG. 6 is a bottom plan view.

1 Claim, 6 Drawing Sheets

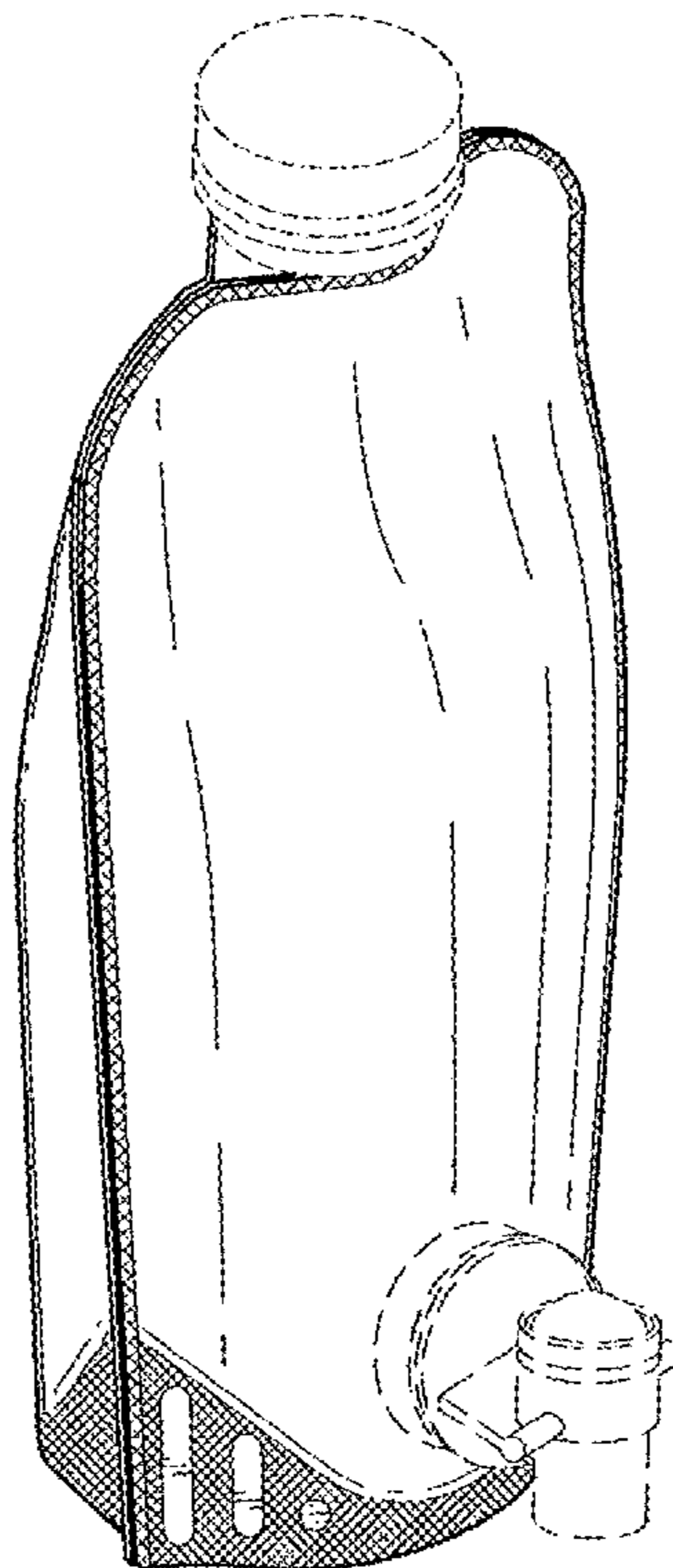

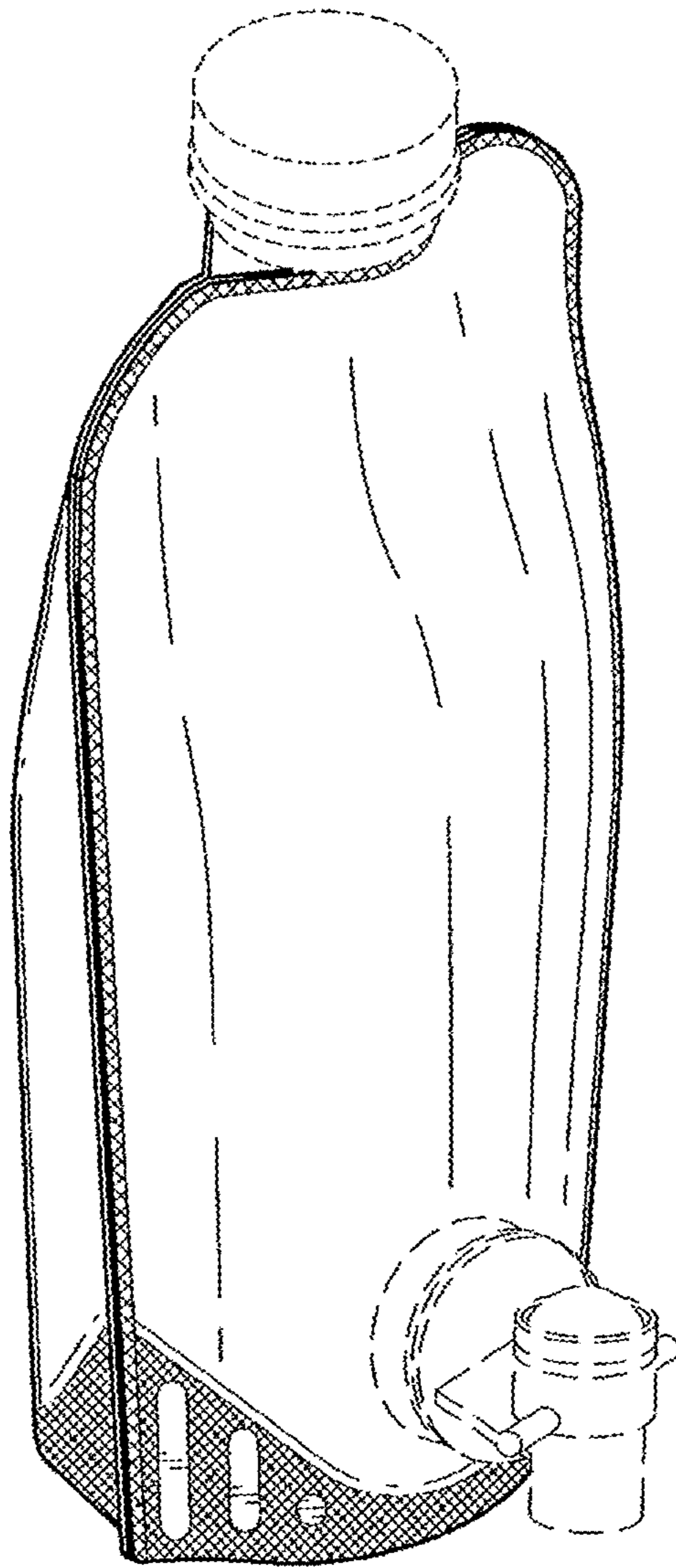

FIG. 1

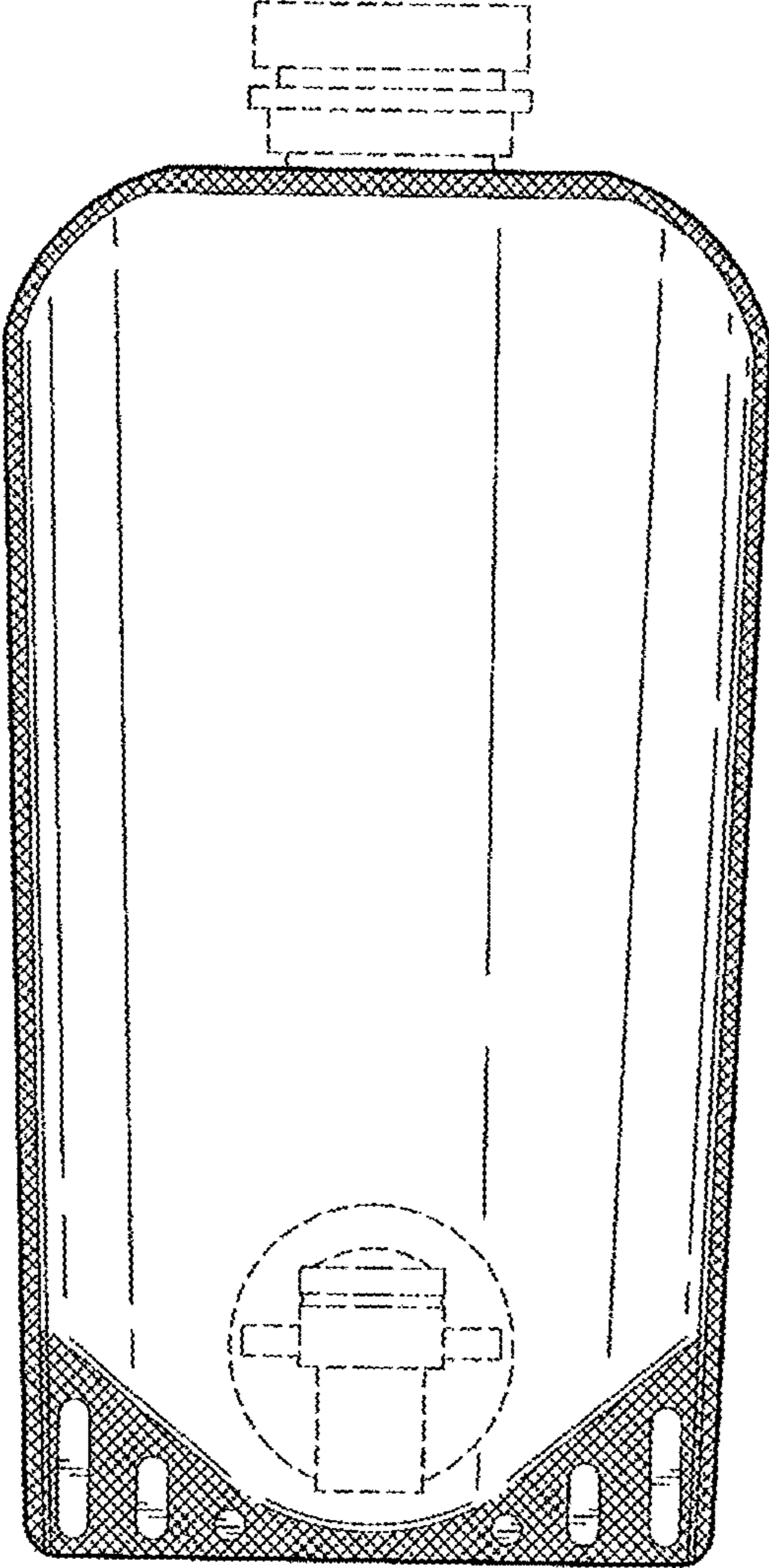

FIG. 2

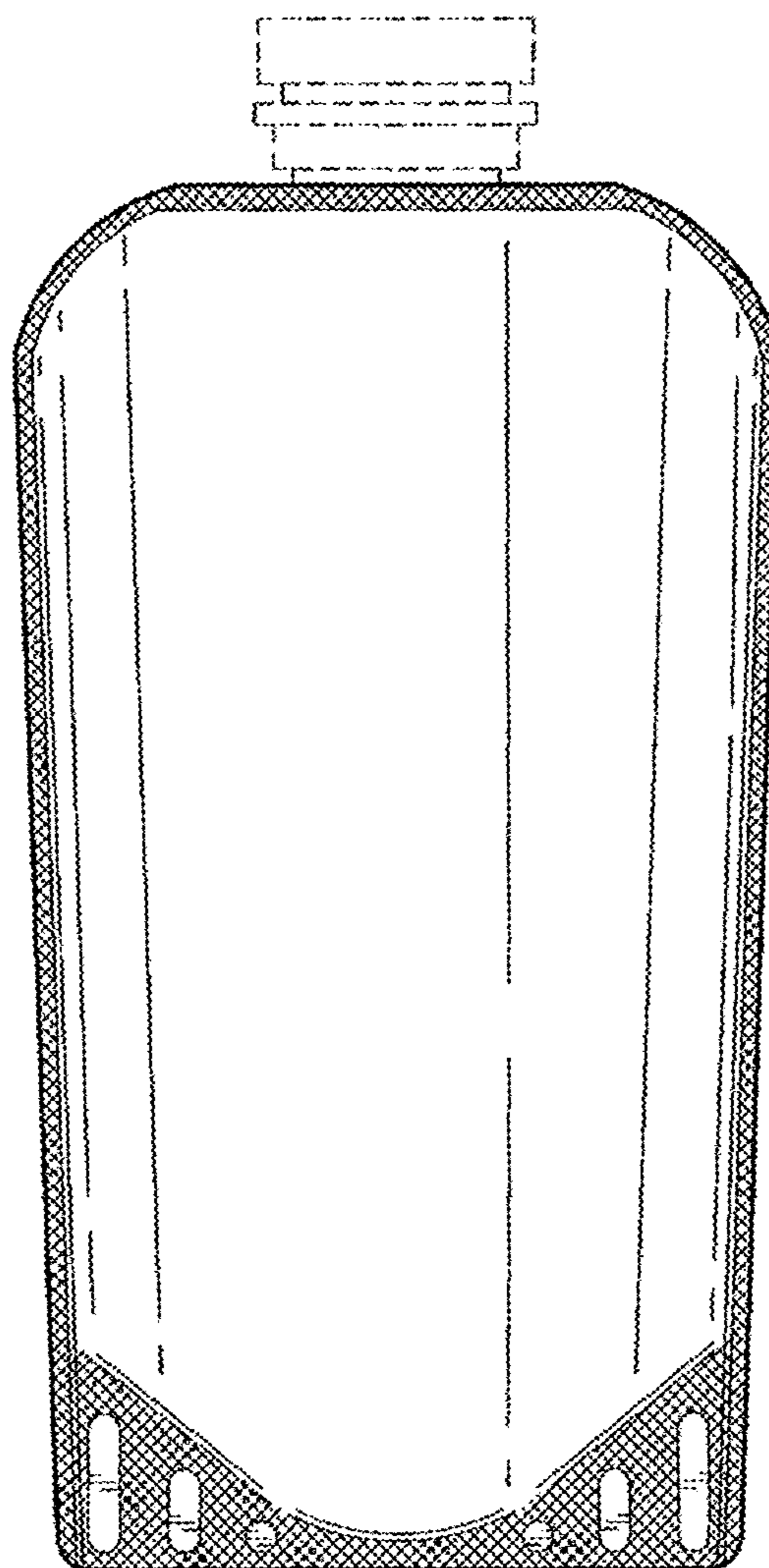

FIG. 3

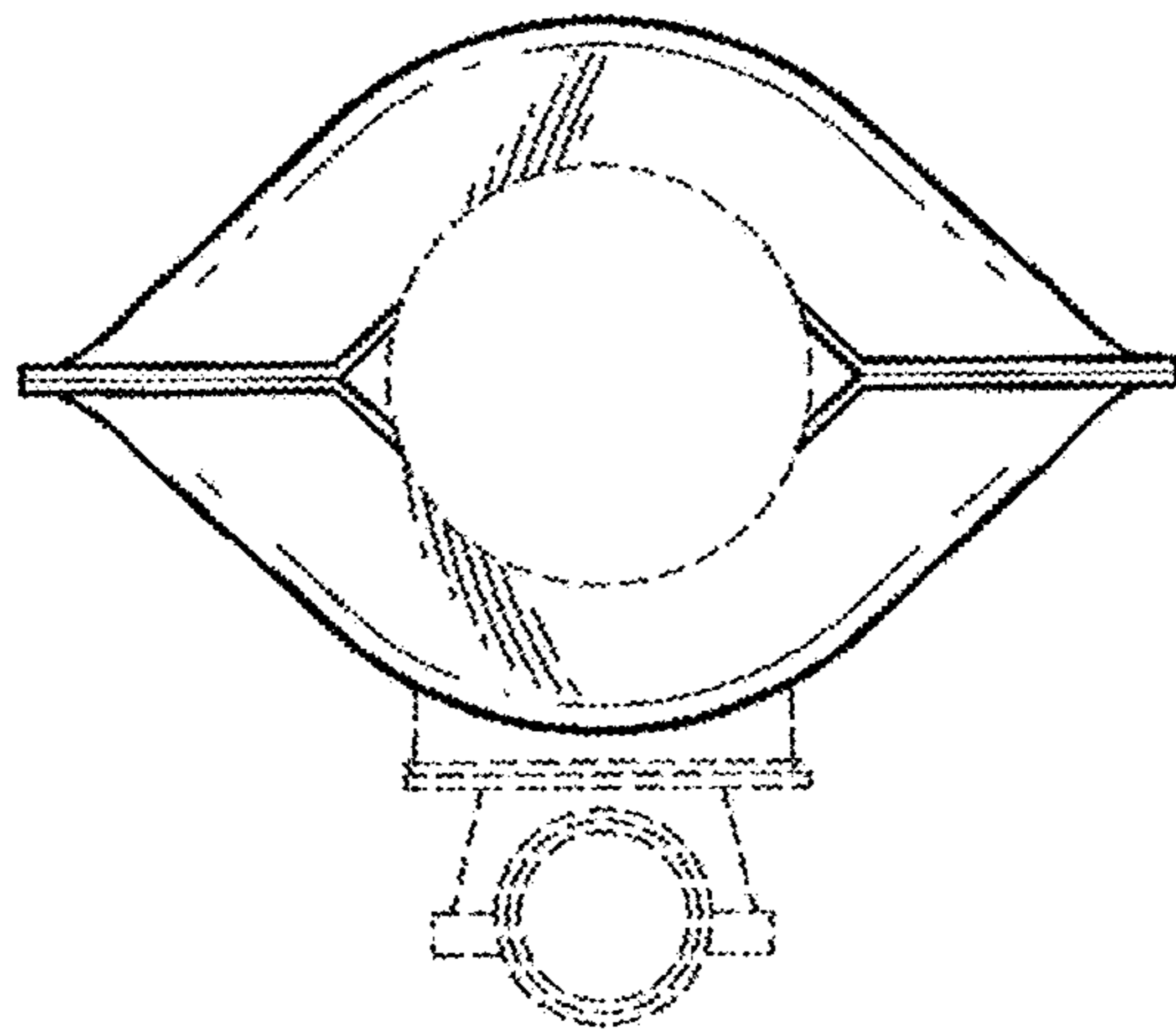

FIG. 4

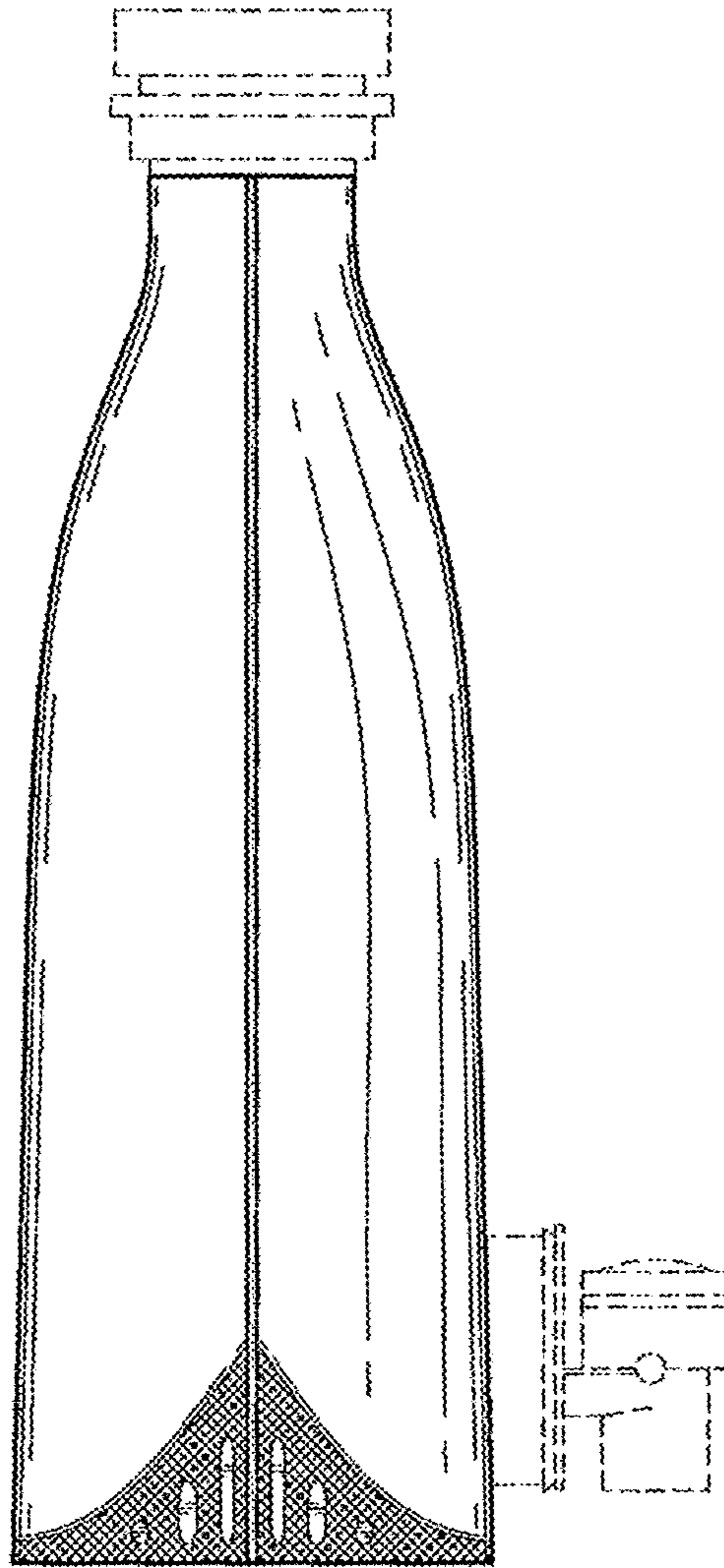

FIG. 5

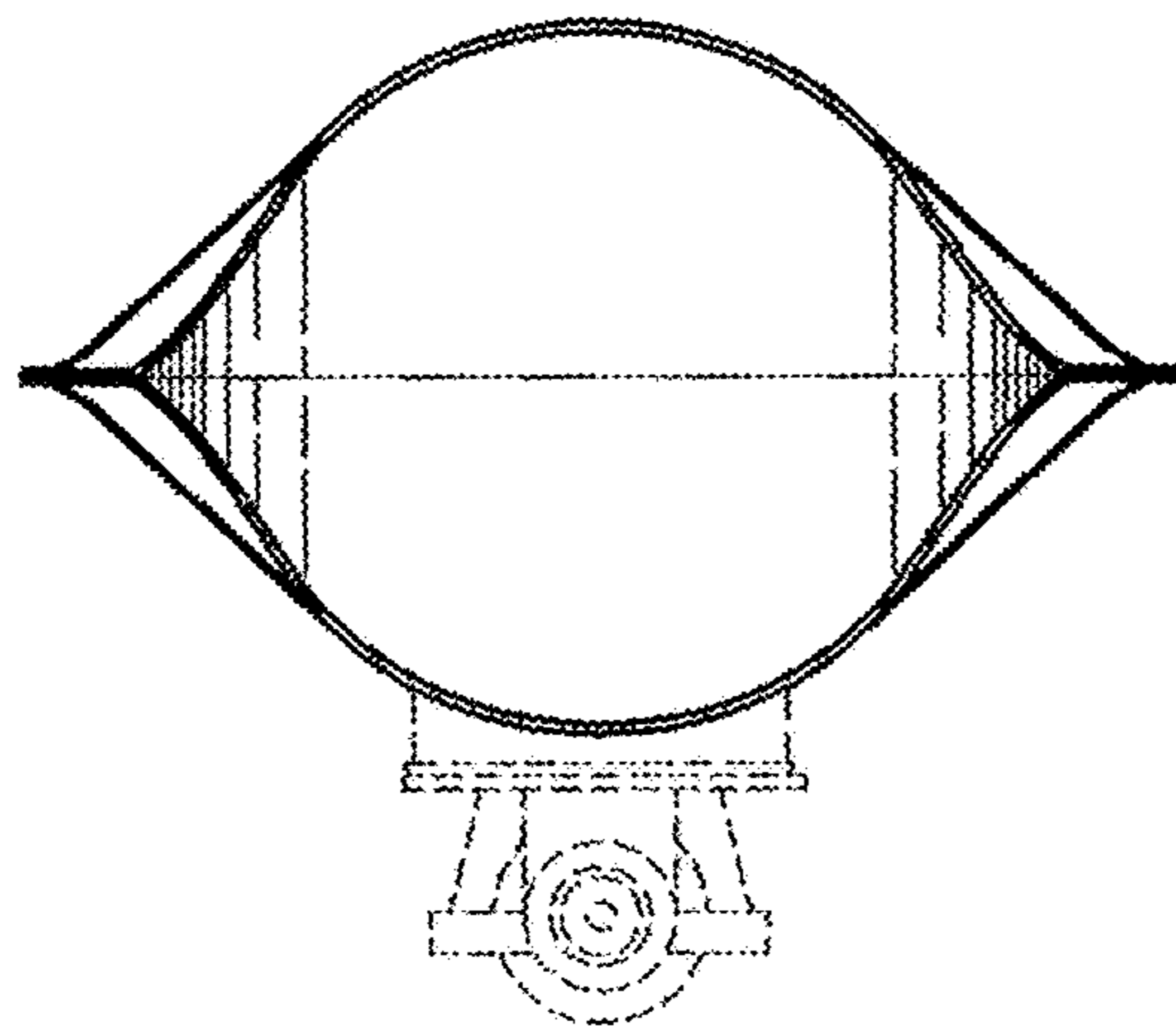

FIG. 6