



US00D832693S

(12) **United States Design Patent** (10) **Patent No.:** **US D832,693 S**  
**Ksiazek et al.** (45) **Date of Patent:** **\*\* Nov. 6, 2018**

(54) **TOWEL CLIP**  
(71) Applicant: **O2COOL, LLC**, Chicago, IL (US)  
(72) Inventors: **Michael Ksiazek**, Burr Ridge, IL (US);  
**Luis Lahens**, Boca Raton, FL (US);  
**Mak Shek Fung**, Hong Kong (CN)  
(73) Assignee: **O2COOL, LLC**, Chicago, IL (US)  
(\*\*) Term: **15 Years**  
(21) Appl. No.: **29/599,895**  
(22) Filed: **Apr. 7, 2017**  
(51) **LOC (11) Cl.** ..... **08-08**  
(52) **U.S. Cl.**  
USPC ..... **D8/395**  
(58) **Field of Classification Search**  
USPC ..... D8/349, 382, 394, 395, 398; D23/376;  
D26/125  
CPC .. A47G 25/485; B65D 33/1675; D06F 55/02;  
F16B 2/10; F16B 2/20  
See application file for complete search history.

(56) **References Cited**  
U.S. PATENT DOCUMENTS  
D249,128 S \* 8/1978 Stookey ..... D10/74  
D299,006 S \* 12/1988 Mednick ..... D21/599  
D365,017 S \* 12/1995 Rohrig ..... D8/394  
D414,006 S \* 9/1999 Ancona ..... D21/597  
D477,528 S \* 7/2003 Adams ..... D19/65  
D477,987 S \* 8/2003 Adams ..... D19/65  
D477,988 S \* 8/2003 Adams ..... D19/65  
D533,804 S \* 12/2006 Anastasiadis ..... D11/84  
D561,573 S \* 2/2008 Hyde ..... D8/395  
D612,455 S \* 3/2010 Henderson ..... D21/597  
D614,246 S \* 4/2010 Cohen ..... D21/472  
D622,784 S \* 8/2010 Cohen ..... D10/46.2  
D631,103 S \* 1/2011 Cohen ..... D21/472  
D670,998 S \* 11/2012 Lavoie ..... D8/395

D671,822 S \* 12/2012 van der Lande ..... D8/395  
D671,823 S \* 12/2012 van der Lande ..... D8/395  
D671,824 S \* 12/2012 van der Lande ..... D8/395  
D671,825 S \* 12/2012 van der Lande ..... D8/395  
D690,459 S \* 9/2013 Asquith ..... D26/125  
D697,396 S \* 1/2014 Goodman ..... D8/395  
D697,397 S \* 1/2014 Goodman ..... D8/395  
D705,646 S \* 5/2014 Finn ..... D8/395  
D706,616 S \* 6/2014 Katz ..... D8/394  
D707,546 S \* 6/2014 Katz ..... D8/394  
D714,681 S \* 10/2014 Katz ..... D11/215  
D720,816 S \* 1/2015 Nelson ..... D21/453  
D721,948 S \* 2/2015 Hellkamp ..... D8/395  
D725,462 S \* 3/2015 Zilisch ..... D8/395  
D743,245 S \* 11/2015 Roeters ..... D8/395  
D750,476 S \* 3/2016 Huang ..... D8/395  
D751,377 S \* 3/2016 Duffy ..... D8/395  
D752,965 S \* 4/2016 Blaney ..... D8/394

(Continued)

*Primary Examiner* — John Windmuller  
*Assistant Examiner* — Steven J Czyz  
(74) *Attorney, Agent, or Firm* — Thompson Coburn LLP

(57) **CLAIM**  
The ornamental design for a towel clip, as shown and described.

**DESCRIPTION**

FIG. 1 is a perspective view of a towel clip showing our new design;  
FIG. 2 is a front view thereof;  
FIG. 3 is a rear view thereof;  
FIG. 4 is a left side view thereof;  
FIG. 5 is a right side view thereof;  
FIG. 6 is a top view thereof; and,  
FIG. 7 is a bottom view thereof.  
The dot-dash-dot lines in the drawings represent the boundary of the claim and form no part of the claimed design. The broken lines depict portions of the article that form no part of the claimed design.

**1 Claim, 7 Drawing Sheets**

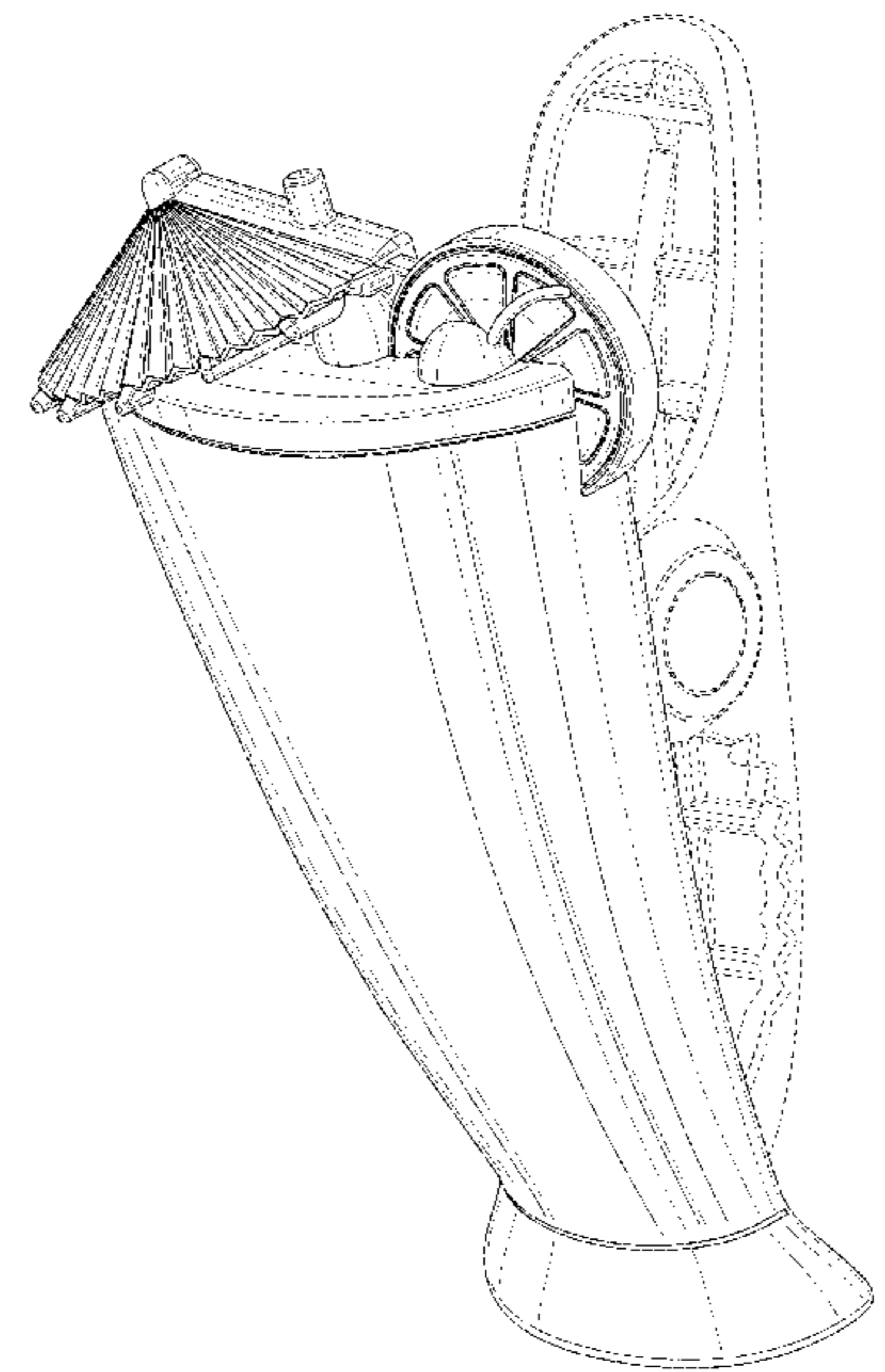

(56)

**References Cited**

U.S. PATENT DOCUMENTS

D752,966 S *	4/2016	Katz .....	D8/395
D752,967 S *	4/2016	Katz .....	D8/395
D753,775 S *	4/2016	Majure Maysan .....	D21/597
D755,620 S *	5/2016	Li .....	D8/395
D787,926 S *	5/2017	Cramer .....	D8/394
D794,437 S *	8/2017	Zinser .....	D8/395
D795,050 S *	8/2017	Kim .....	D8/395
D796,945 S *	9/2017	Stokeley .....	D8/395
D798,139 S *	9/2017	Giannatti .....	D8/394
D799,022 S *	10/2017	Ksiazek .....	D23/411
D799,951 S *	10/2017	Habraken .....	D8/395

\* cited by examiner

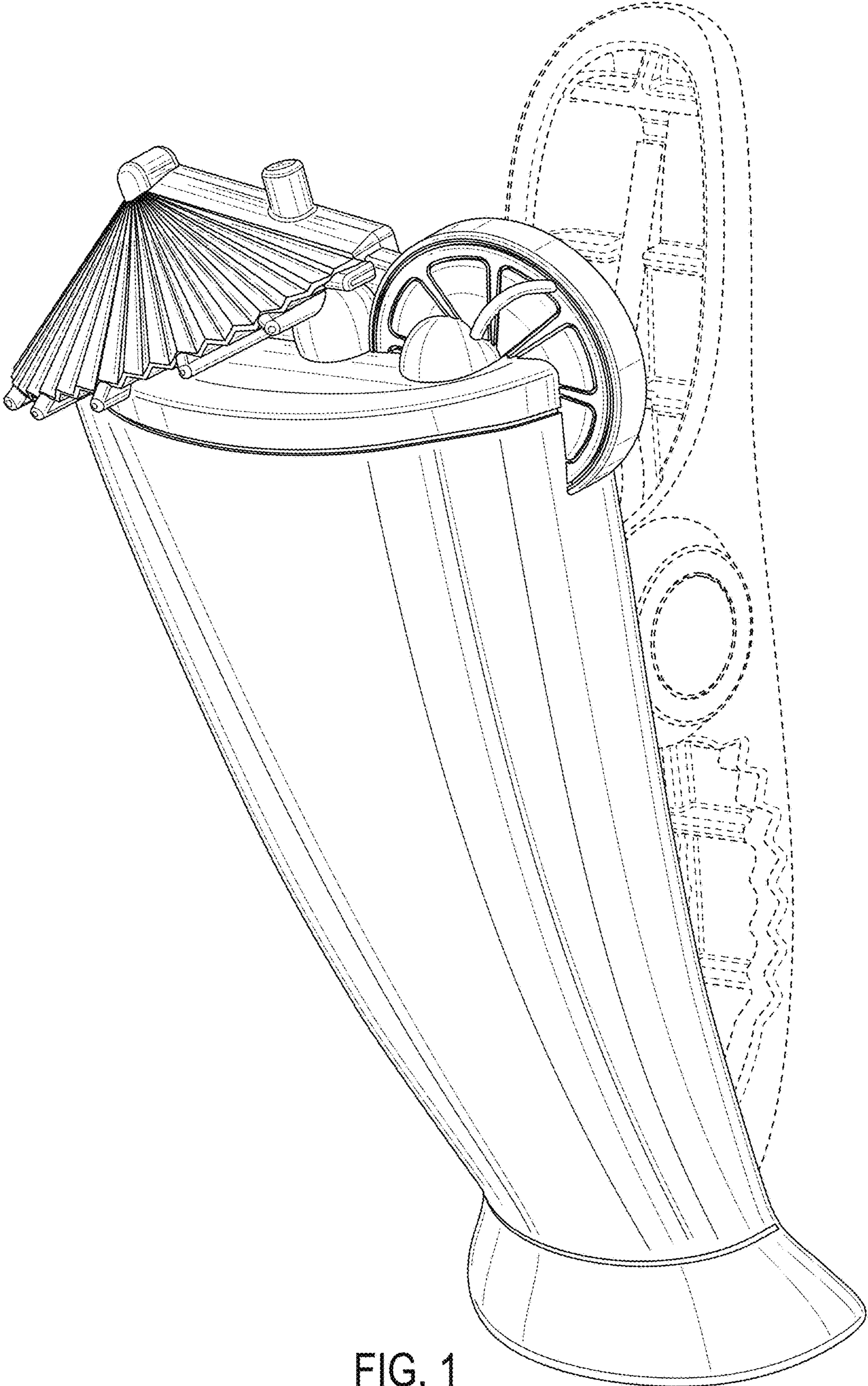

FIG. 1

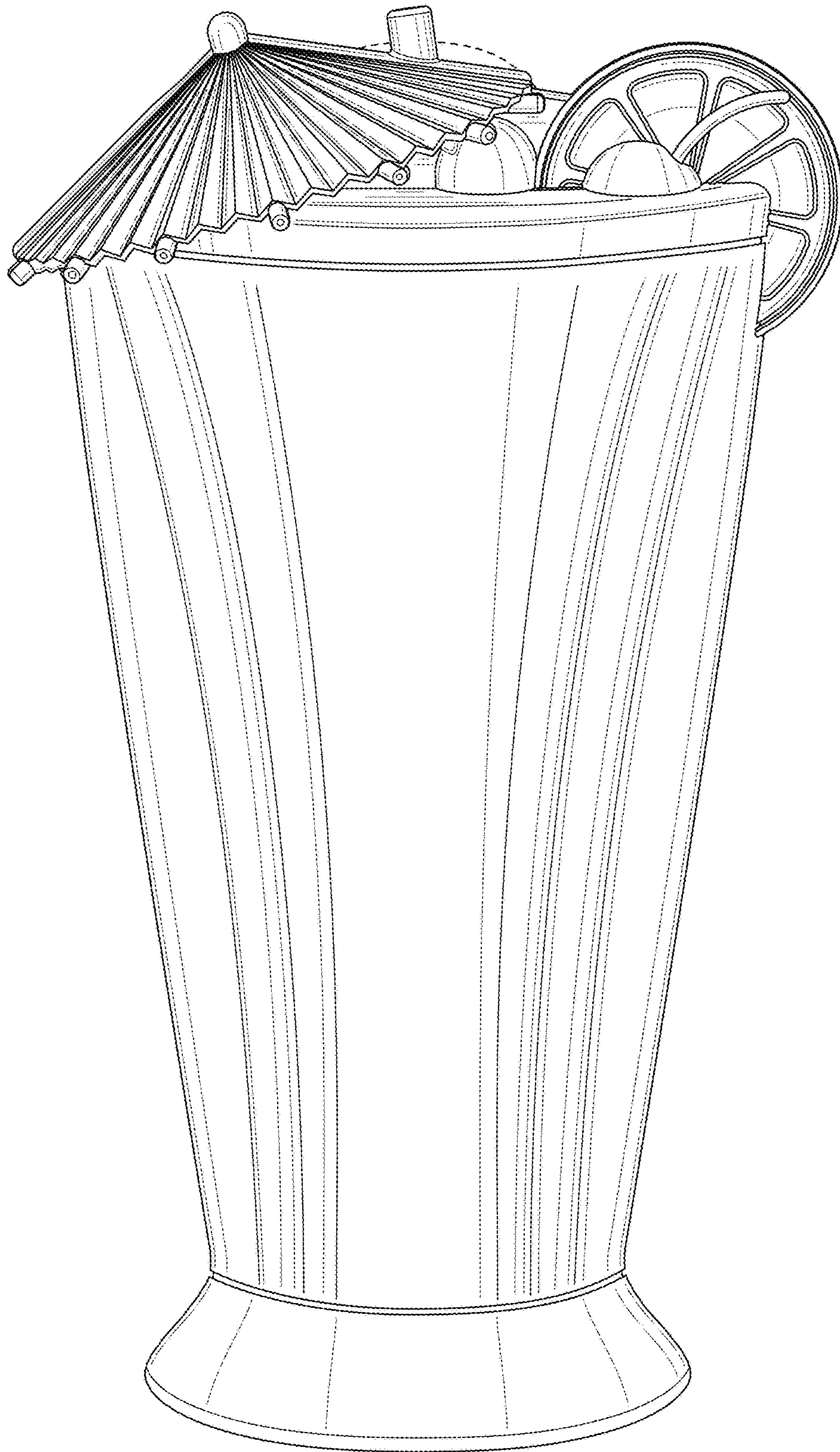

FIG. 2

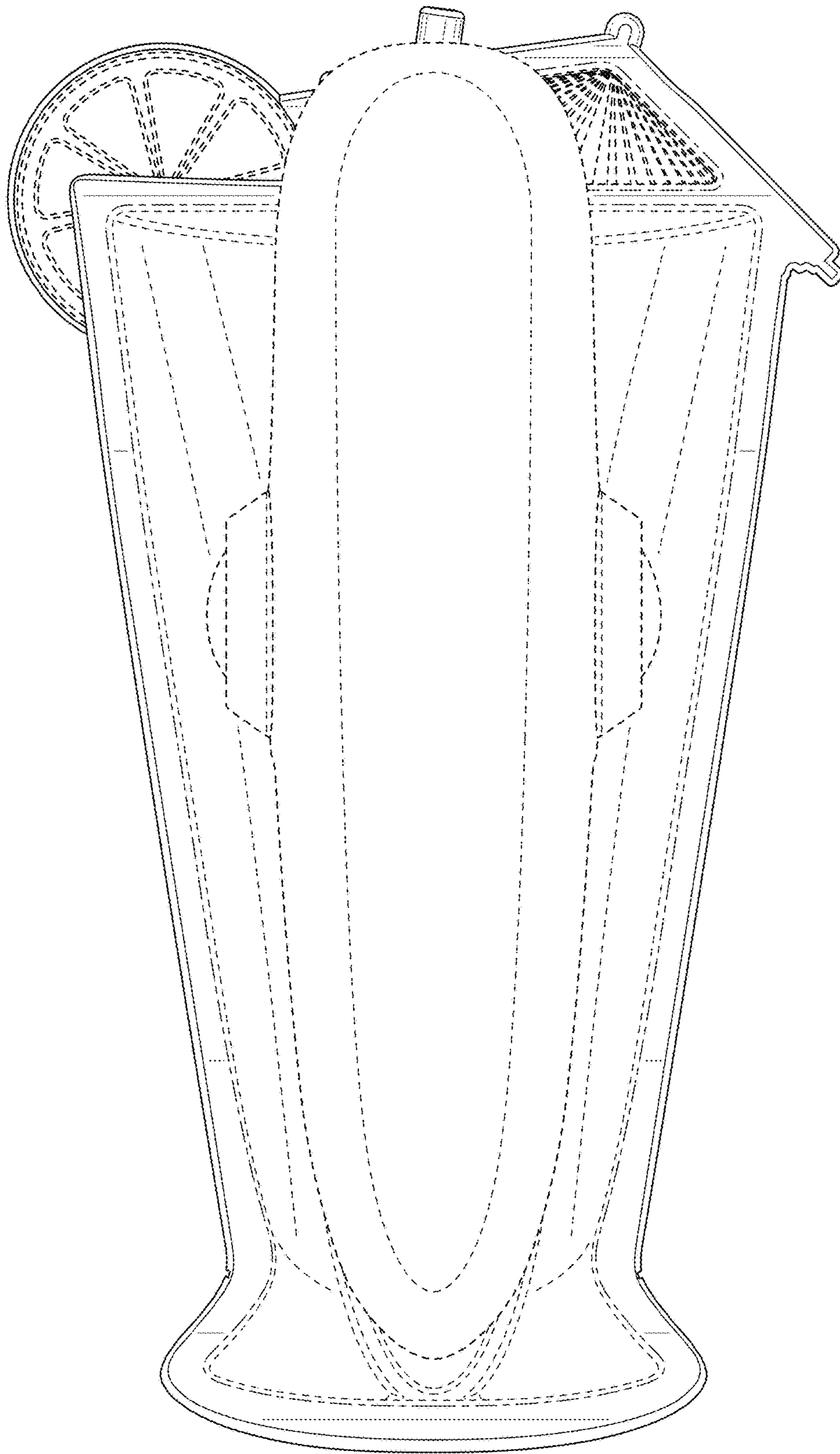

FIG. 3

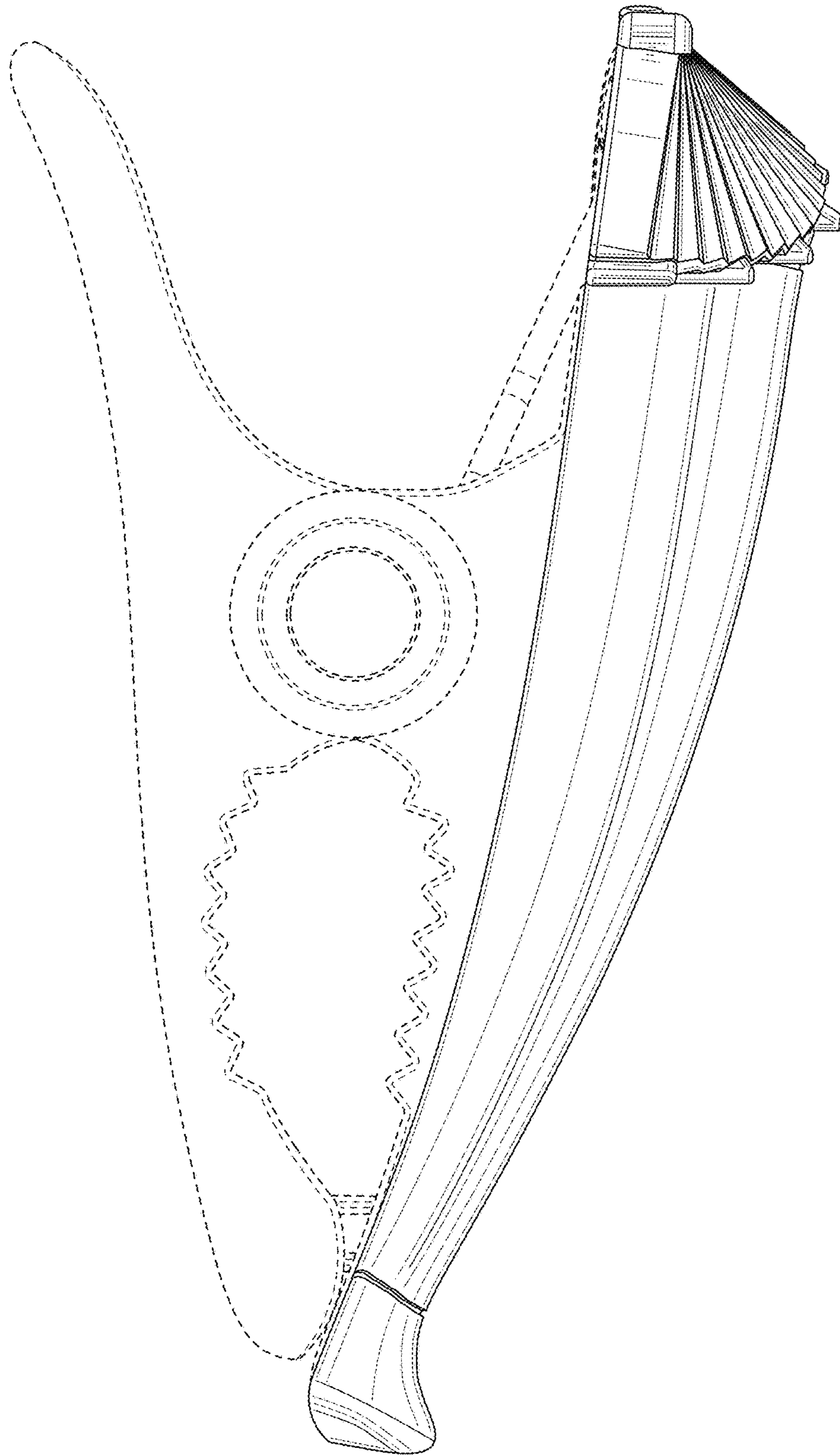

FIG. 4

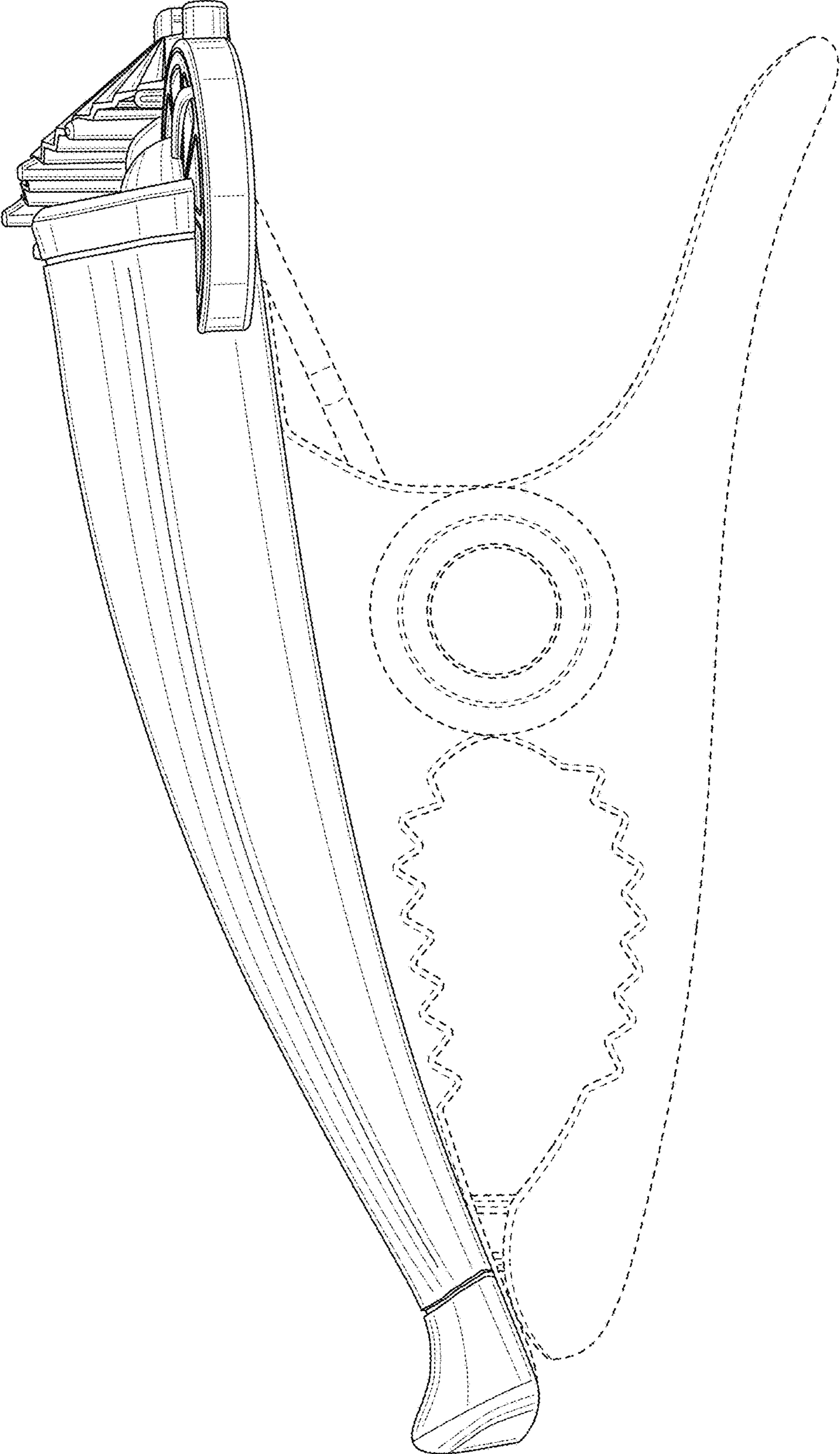

FIG. 5

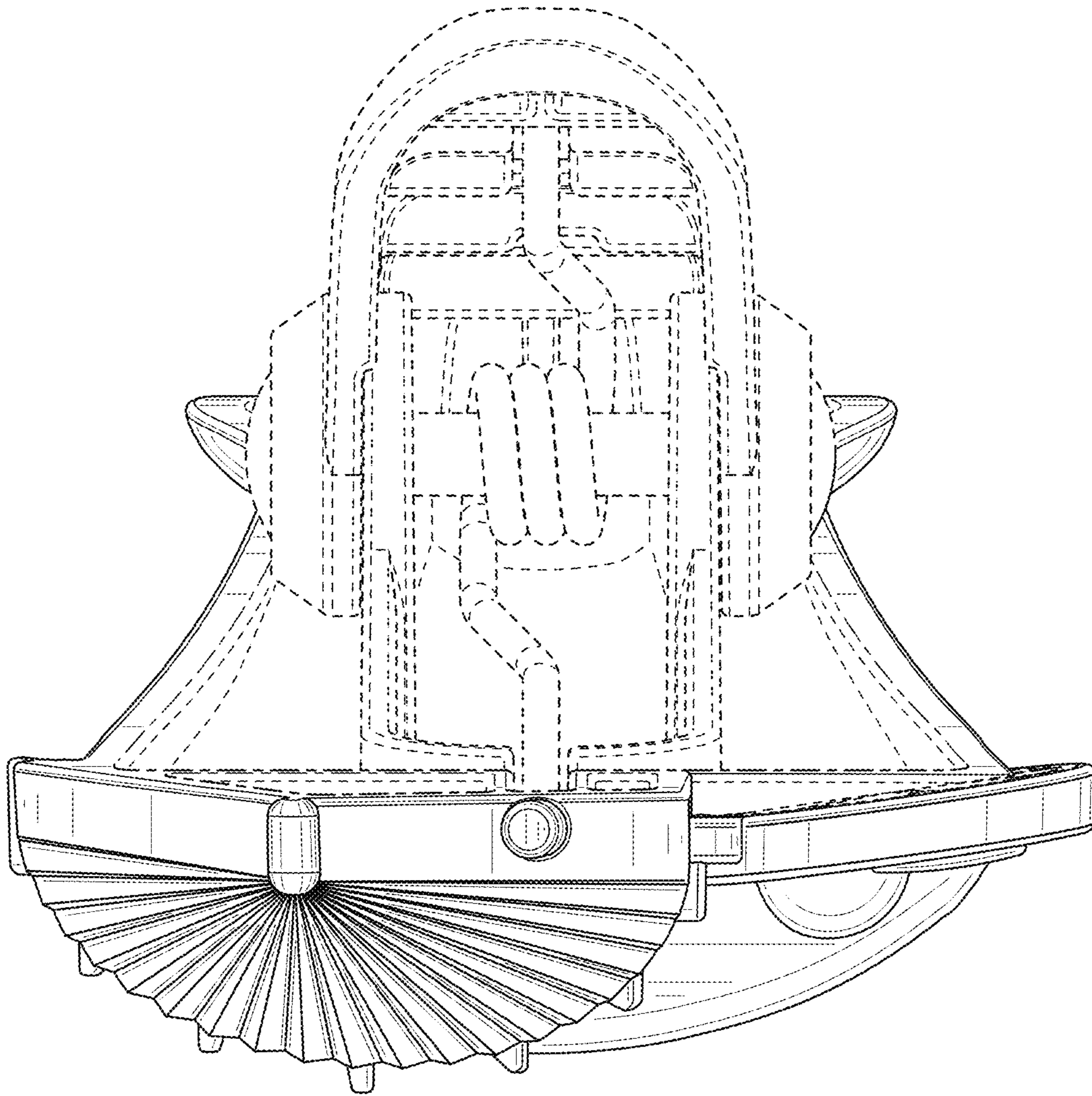

FIG. 6



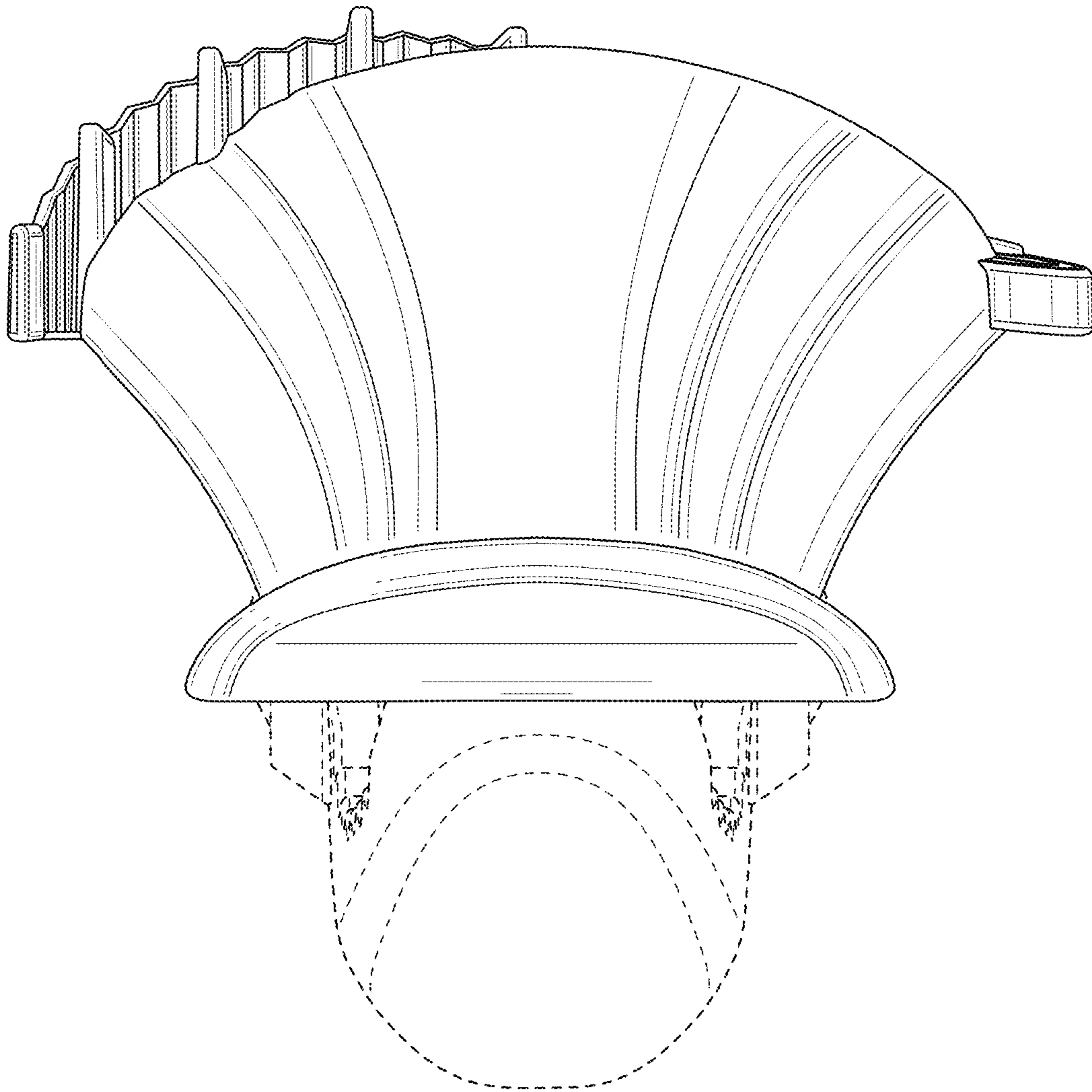

FIG. 7