



US00D832650S

(12) **United States Design Patent**
Diebel et al.

(10) **Patent No.:** **US D832,650 S**
(45) **Date of Patent:** **** Nov. 6, 2018**

(54) **WATER BOTTLE**
(71) Applicant: **FC Brands LLC**, New York, NY (US)
(72) Inventors: **Markus Peter Diebel**, San Francisco, CA (US); **Joe Sung-Ho Tan**, San Francisco, CA (US)
(73) Assignee: **FC Brands LLC**, New York, NY (US)
(**) Term: **15 Years**
(21) Appl. No.: **29/581,695**

D467,804 S * 12/2002 Restrepo D9/500
D490,321 S * 5/2004 Durant D9/500
D509,433 S * 9/2005 Trayser D9/501
D548,089 S * 8/2007 Waldner D9/503
D548,090 S * 8/2007 Waldner D9/503
D553,914 S * 10/2007 Wahl D7/608
D607,747 S * 1/2010 Cella D9/500
D627,227 S * 11/2010 Andis D7/510
D630,474 S * 1/2011 Gilbert D7/608
8,371,244 B2 * 2/2013 Krasner A01K 7/00
119/72.5
D689,332 S * 9/2013 Krasner D30/132
D691,475 S * 10/2013 Potts D9/500

(Continued)

(22) Filed: **Oct. 20, 2016**
(51) **LOC (11) Cl.** **07-01**
(52) **U.S. Cl.**
USPC **D7/511**; D7/523; D7/532; D9/501;
D9/503
(58) **Field of Classification Search**
USPC D7/507, 509, 510, 511, 523, 529, 530,
D7/608, 536, 532, 624.1, 624.2; D9/500,
D9/502, 503, 504, 517, 530, 538, 539,
D9/540, 541, 544, 545, 547, 548, 552,
D9/569, 453, 452, 501; 220/592.16,
220/592.17; 215/396, 397, 398
CPC A47G 19/22; A47G 19/2205; A47G
19/2211; A47G 19/2266; A47G 19/2272;
A45F 3/16; B65D 41/04
See application file for complete search history.

OTHER PUBLICATIONS

<http://a2.leadongcdn.com/cloud/qkBonKRiSinjnlqi/silicone-s.jpg> Tin
Eye Results Feb. 29, 2016.*

(Continued)

Primary Examiner — Marianne N Pandozzi
Assistant Examiner — Jae Liang
(74) *Attorney, Agent, or Firm* — Pierce Atwood LLP

(57) **CLAIM**

The ornamental design for a water bottle, as shown and described.

DESCRIPTION

FIG. 1 is a front isometric view of a water bottle showing our new design;
FIG. 2 is a front elevational view thereof;
FIG. 3 is a rear elevational view thereof;
FIG. 4 is a left side elevational view thereof;
FIG. 5 is a right side elevational view thereof;
FIG. 6 is a top view thereof; and,
FIG. 7 is a bottom view thereof.
The broken lines in the drawings depict portions of the water bottle that form no part of the claimed design.

1 Claim, 4 Drawing Sheets

(56) **References Cited**

U.S. PATENT DOCUMENTS

D242,017 S * 10/1976 Raynokis D9/501
D274,221 S * 6/1984 Biesecker D9/501
D276,889 S * 12/1984 Biesecker D9/500
D289,260 S * 4/1987 Weckman D9/501
D310,328 S * 9/1990 Dinand D9/434
D321,628 S * 11/1991 Kobayashi D7/608
D354,915 S * 1/1995 Schneider D9/454
D406,062 S * 2/1999 Brewer D9/520
D422,916 S * 4/2000 Herrmann D9/443

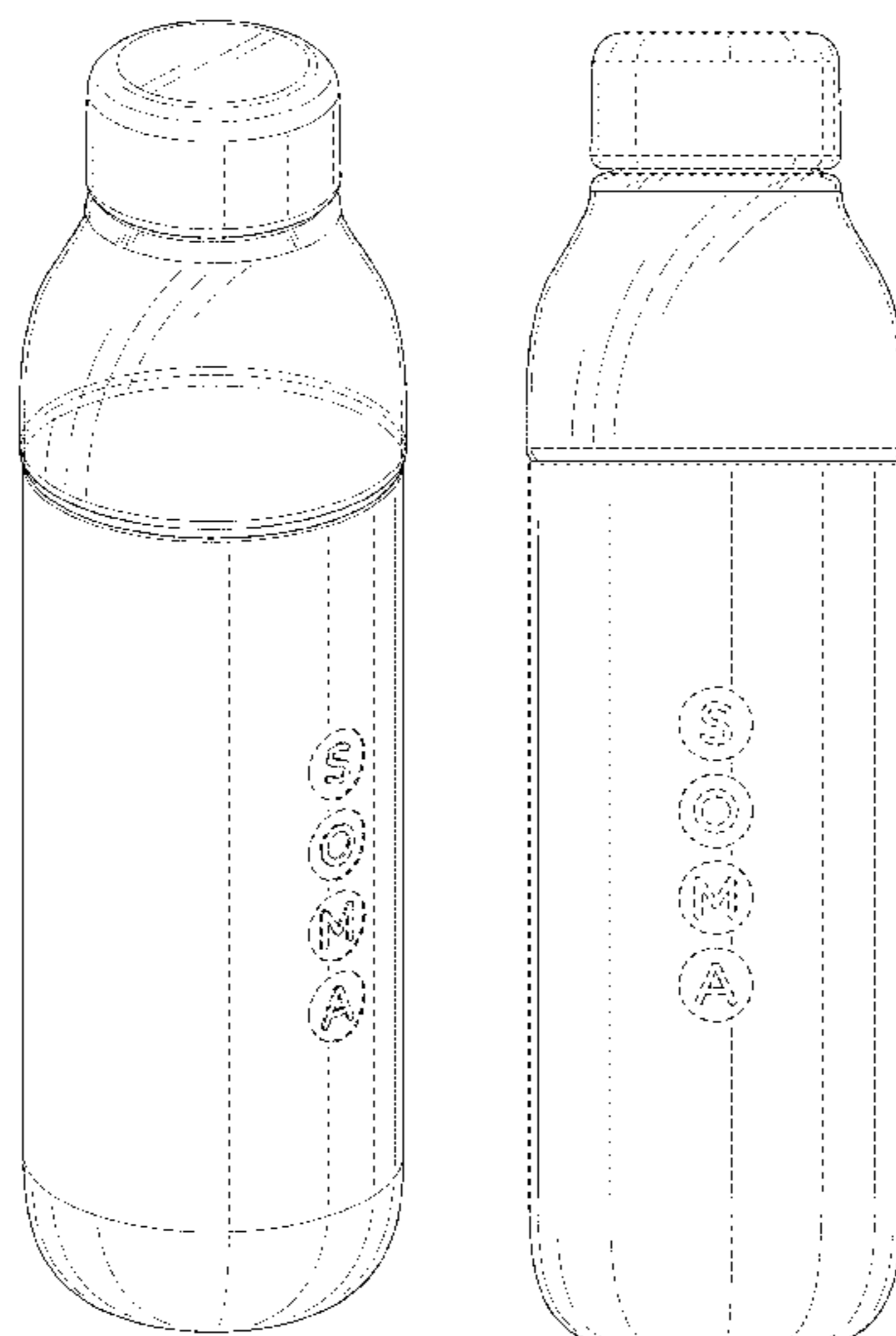

(56)

References Cited

U.S. PATENT DOCUMENTS

D696,945	S *	1/2014	Newman	D9/500
D697,418	S *	1/2014	Maier	D7/598
D697,804	S *	1/2014	Hanson	D9/500
D705,063	S *	5/2014	Weiss	D9/500
D724,896	S *	3/2015	Williams	D7/511
D743,259	S *	11/2015	Delacourt	D9/500
D743,741	S *	11/2015	Itzhaki	D7/510
D752,440	S *	3/2016	Fleischhacker	D9/500
D753,442	S *	4/2016	Weernink	D7/507
D779,881	S *	2/2017	Lee	D7/510
D785,454	S *	5/2017	Dhillon	D9/500
D790,279	S *	6/2017	Izen	D7/509
D796,956	S *	9/2017	Clark	D9/500
2004/0068900	A1 *	4/2004	Moran	G09F 3/00 40/311

OTHER PUBLICATIONS

<https://www.amazon.com/Silicone-Sleeves-Pratico-Kitchen-Similar/dp/B01CL2QOBI> Mar. 5, 2016 Pratico Kitchen.*

https://www.amazon.com/gp/product/B00IR77J52/ref=s9_dcacsd_dcoop_bw_c_x_12_w. Contigo Tranquil Bottle Feb. 12, 2014.*

https://www.amazon.co.jp/...%E7%AD%92-%E3%83%9E%E3%82%B0%E3%83%9C%E3%83%88%E3%83%AB-%E5%AD%A6%E6%A0%A1%E4%BC%9A%E7%A4%BE%E5%90%84%E5%A0%B4%E6%89%80%E7%94%A8/dp/B00X9Z2DI0/ref=pd_lpo_vtph_201_lp_t_3?_encoding=UTF8&psc=1&refRID=BKMWK0PZ8M13EFMYACDV Miu Color May 7, 2015.*

* cited by examiner

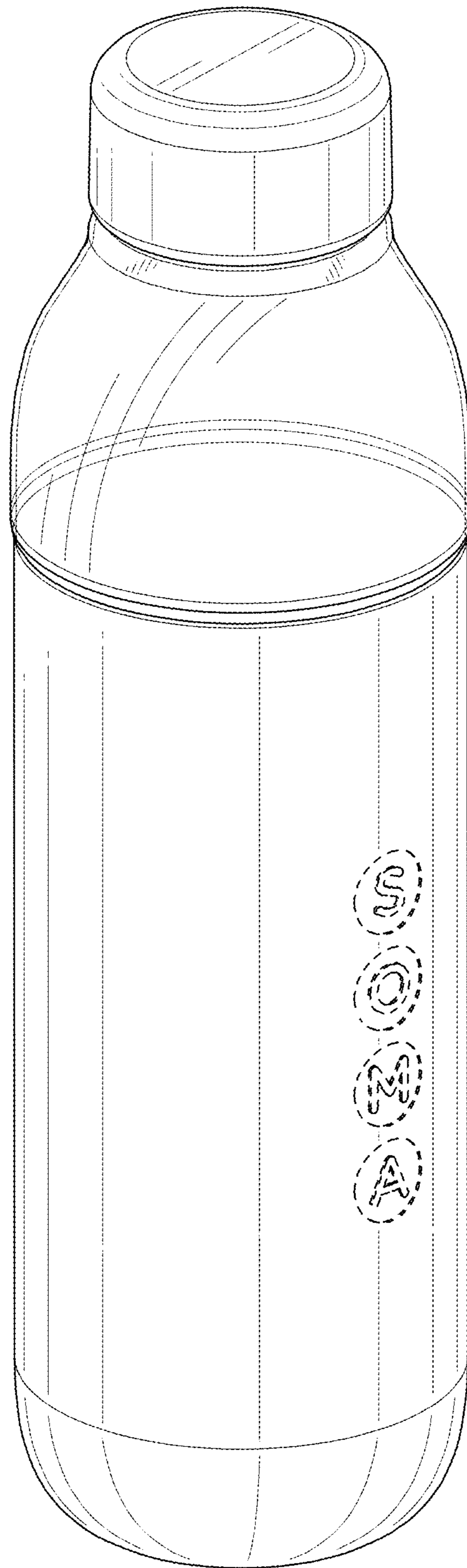

Fig. 1

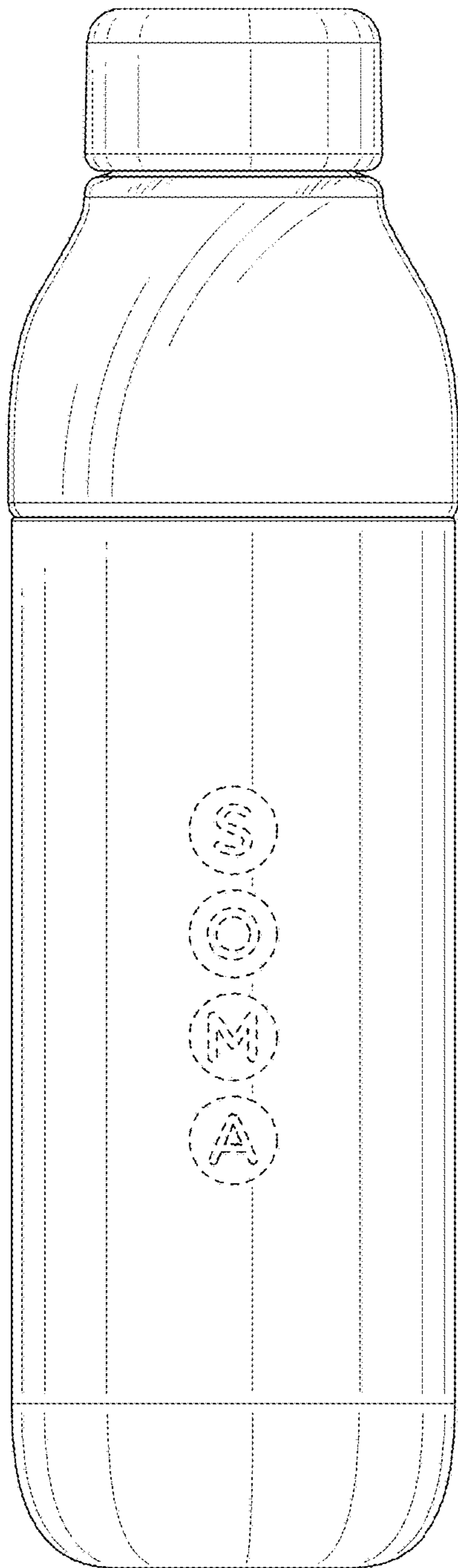

Fig. 2

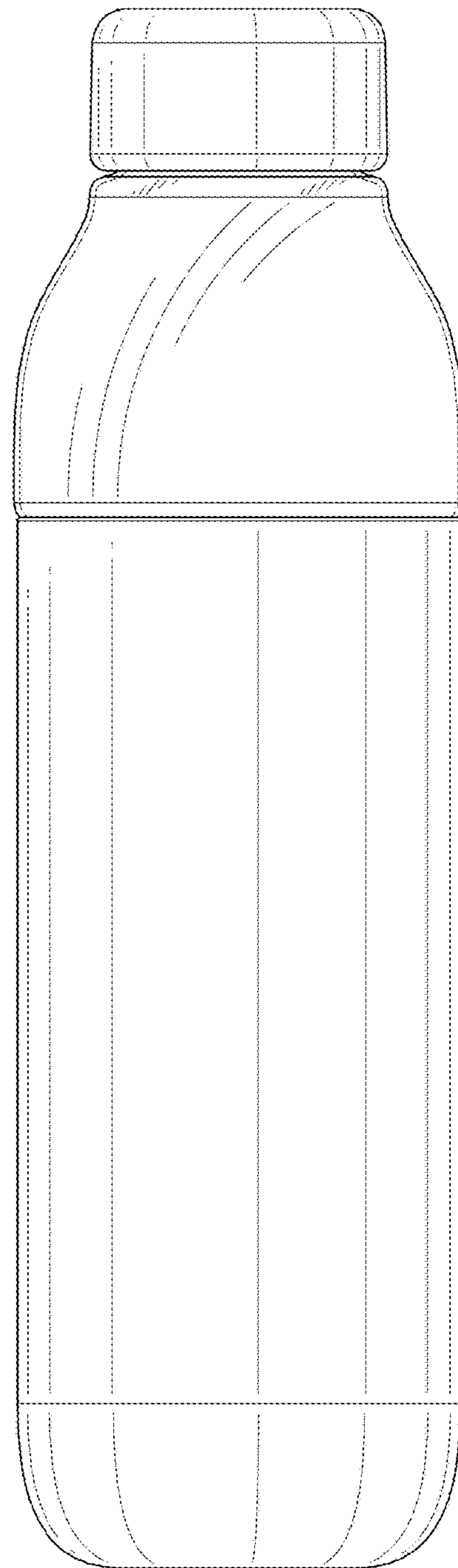

Fig. 3

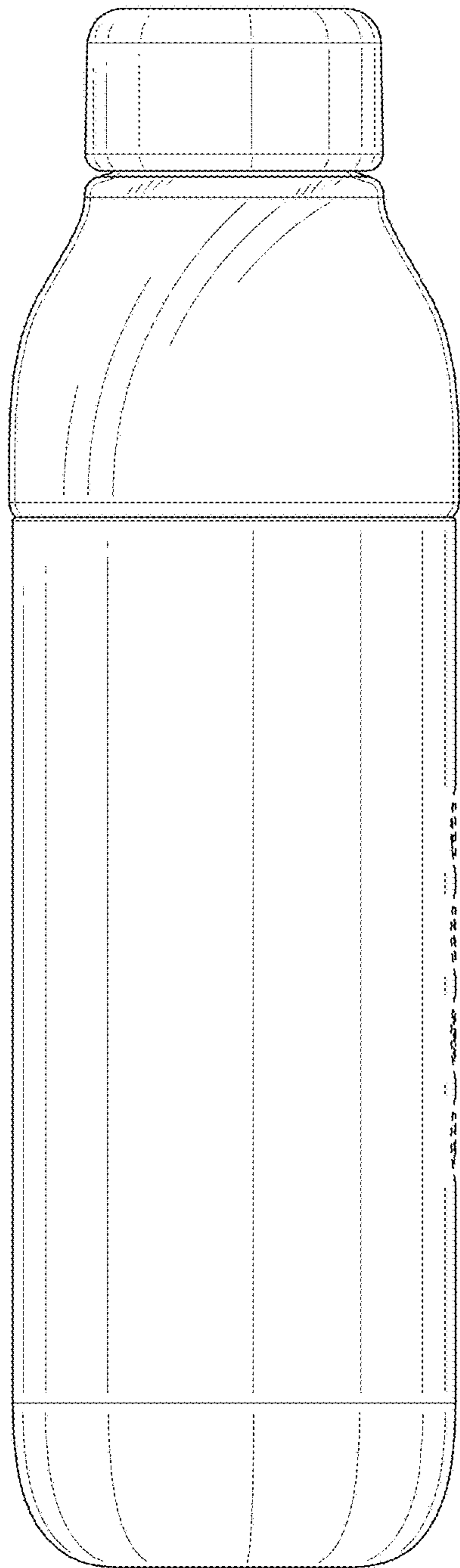

Fig. 4

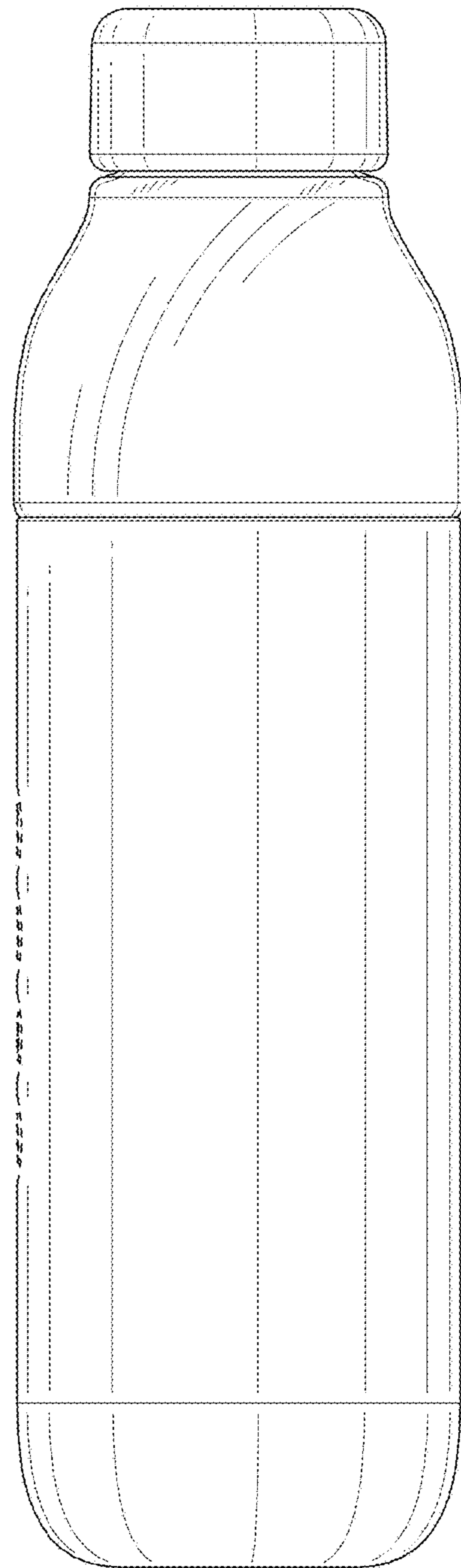

Fig. 5

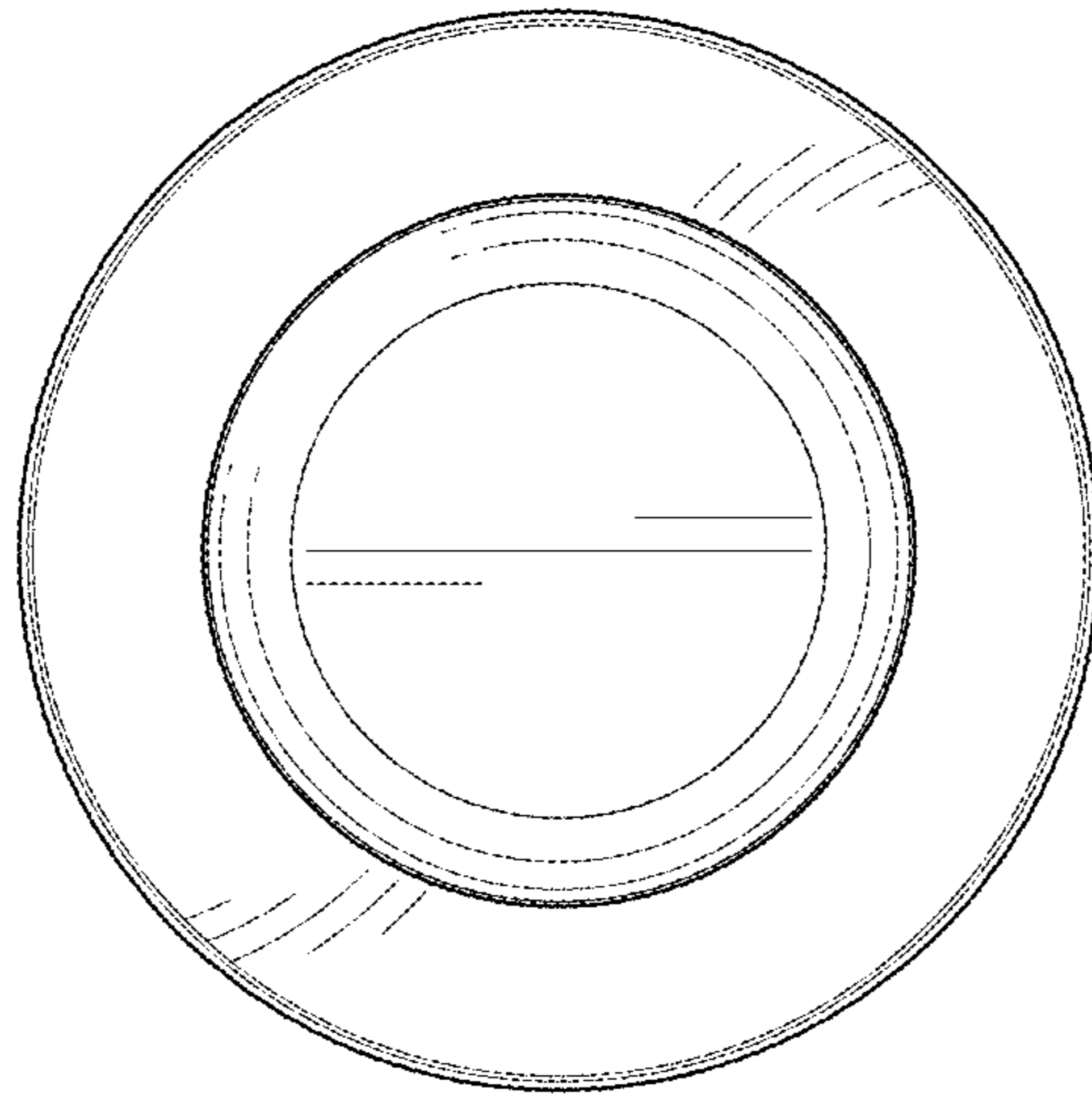

Fig. 6

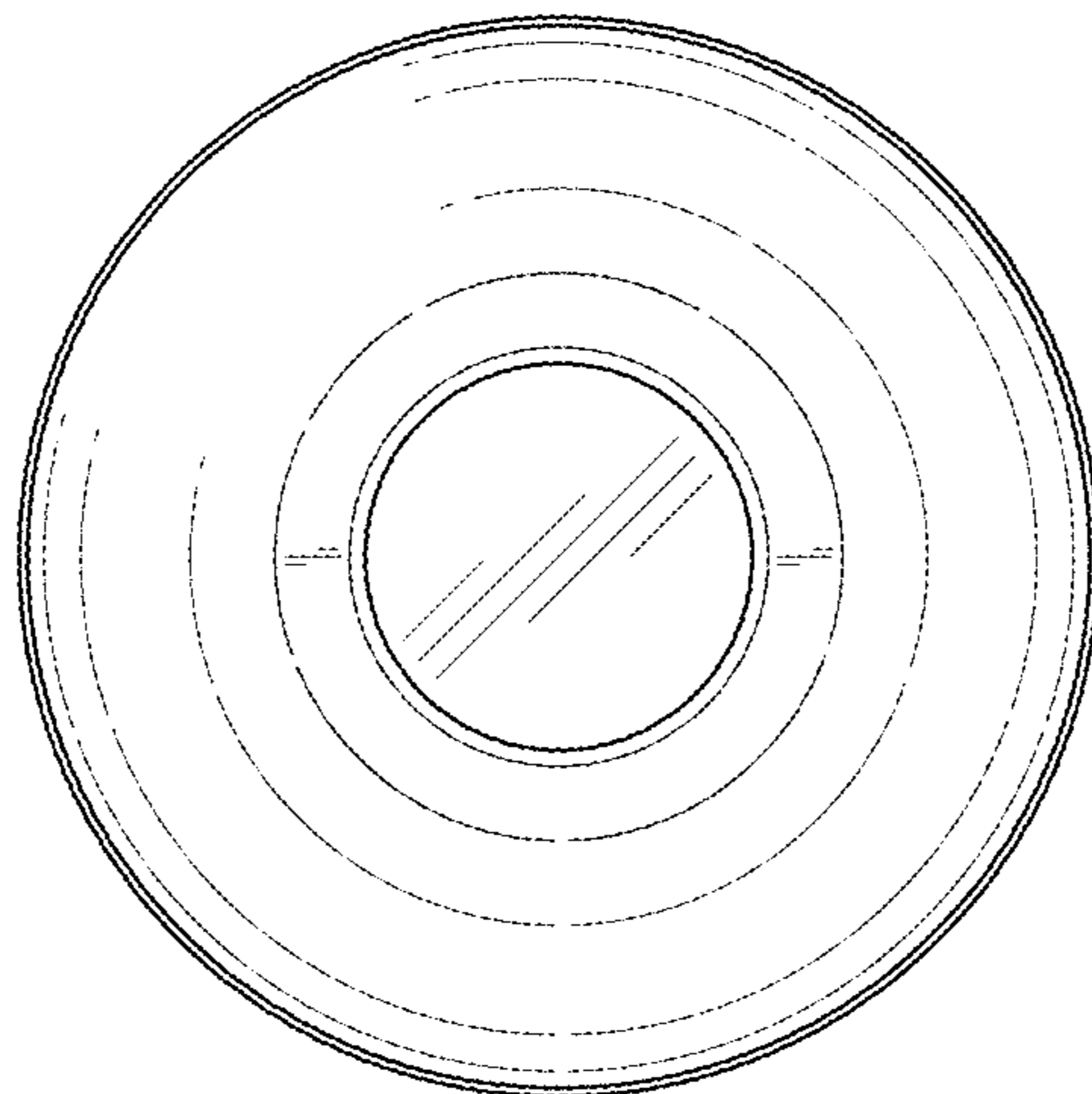

Fig. 7

UNITED STATES PATENT AND TRADEMARK OFFICE
CERTIFICATE OF CORRECTION

PATENT NO. : D832,650 S
APPLICATION NO. : 29/581695
DATED : November 6, 2018
INVENTOR(S) : Markus Peter Diebel et al.

Page 1 of 1

It is certified that error appears in the above-identified patent and that said Letters Patent is hereby corrected as shown below:

On the Title Page

(56) References Cited, US Patent Documents, please amend:

From:

D242,017 S 10/1976 "Raynokis"

To:

D242,017 S 10/1976 -- Reynolds --

Signed and Sealed this
Twelfth Day of February, 2019



Andrei Iancu
Director of the United States Patent and Trademark Office