



US00D832584S

(12) **United States Design Patent**
Composto

(10) **Patent No.:** **US D832,584 S**

(45) **Date of Patent:** **** Nov. 6, 2018**

(54) **HAIR BRUSH**

(71) Applicant: **Sebastian Renzo Composto**, Costa Mesa, CA (US)

(72) Inventor: **Sebastian Renzo Composto**, Costa Mesa, CA (US)

(**) Term: **15 Years**

(21) Appl. No.: **29/614,272**

(22) Filed: **Aug. 17, 2017**

(51) **LOC (11) Cl.** **04-02**

(52) **U.S. Cl.**
USPC **D4/100**

(58) **Field of Classification Search**
USPC D4/100, 108, 110, 11, 116, 117, 120, D4/121, 127, 128, 132-136; D28/10, 13, D28/15, 24, 25, 26, 28, 35, 38, 74
CPC A46B 3/00; A46B 3/22; A46B 5/00; A46B 5/0016; A46B 5/02; A46B 1/00; A46B 9/00; A46B 9/02; A46B 9/023; A46B 9/028; A46B 2200/00; A46B 2200/10; A46B 15/00; A46B 15/0014; A46B 11/08; A45D 24/16

See application file for complete search history.

(56) **References Cited**

U.S. PATENT DOCUMENTS

D362,119 S * 9/1995 Chan D4/133
D570,045 S * 5/2008 Julemont D28/35

D766,504 S * 9/2016 Hollinger D28/15
D766,589 S * 9/2016 Cheung D4/136
D771,310 S * 11/2016 He D28/15
D781,598 S * 3/2017 Treeby D4/136
D804,188 S * 12/2017 Du D4/100
D808,658 S * 1/2018 Sophie D4/100
D815,837 S * 4/2018 Zhou D4/100
2018/0055188 A1* 3/2018 Potts A45D 20/48
2018/0125223 A1* 5/2018 Exley A46B 15/003

* cited by examiner

Primary Examiner — Wan Laymon

Assistant Examiner — Clint A Samuel

(74) *Attorney, Agent, or Firm* — Dunlap Bennett & Ludwig PLLC

(57) **CLAIM**

The ornamental design for a hair brush, as shown and described.

DESCRIPTION

FIG. 1 is a perspective view of a hair brush, showing my new design;
FIG. 2 is a right side elevation view thereof, the left side elevation view being a mirror image thereof;
FIG. 3 is a top plan view thereof;
FIG. 4 is a bottom plan view thereof;
FIG. 5 is a front elevation view thereof; and,
FIG. 6 is a rear elevation view thereof.
The broken lines shown in the drawings depict portions of the hair brush that form no part of the claimed design.

1 Claim, 3 Drawing Sheets

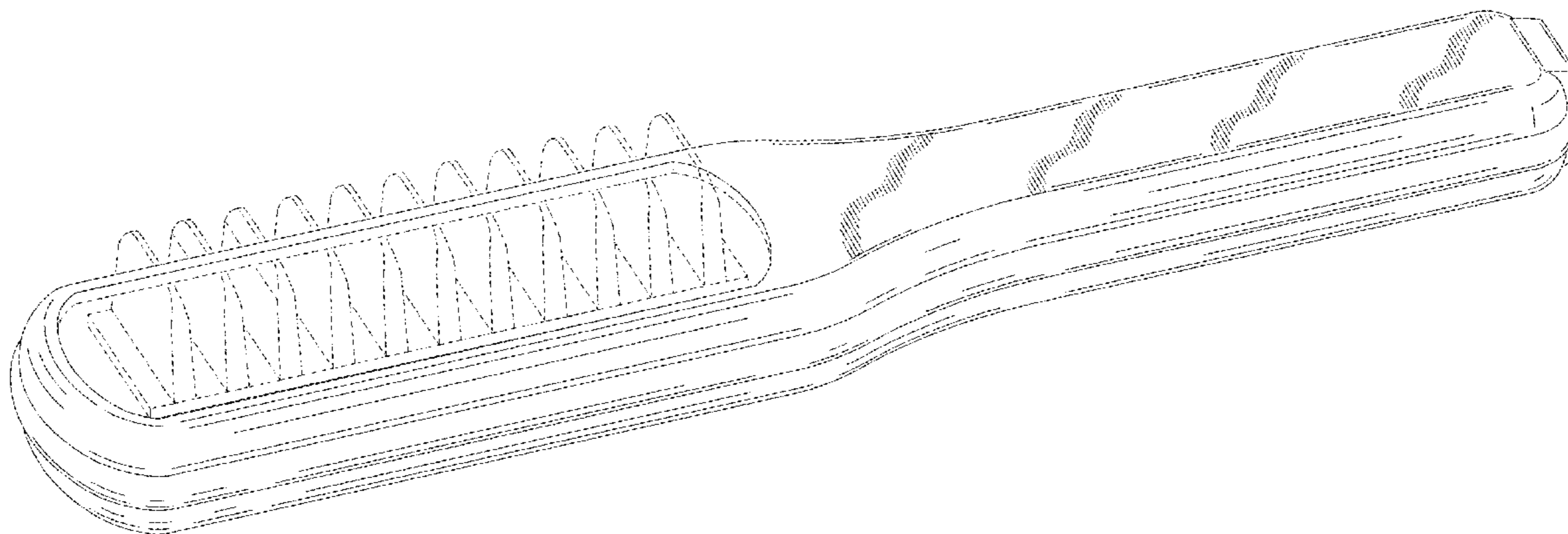

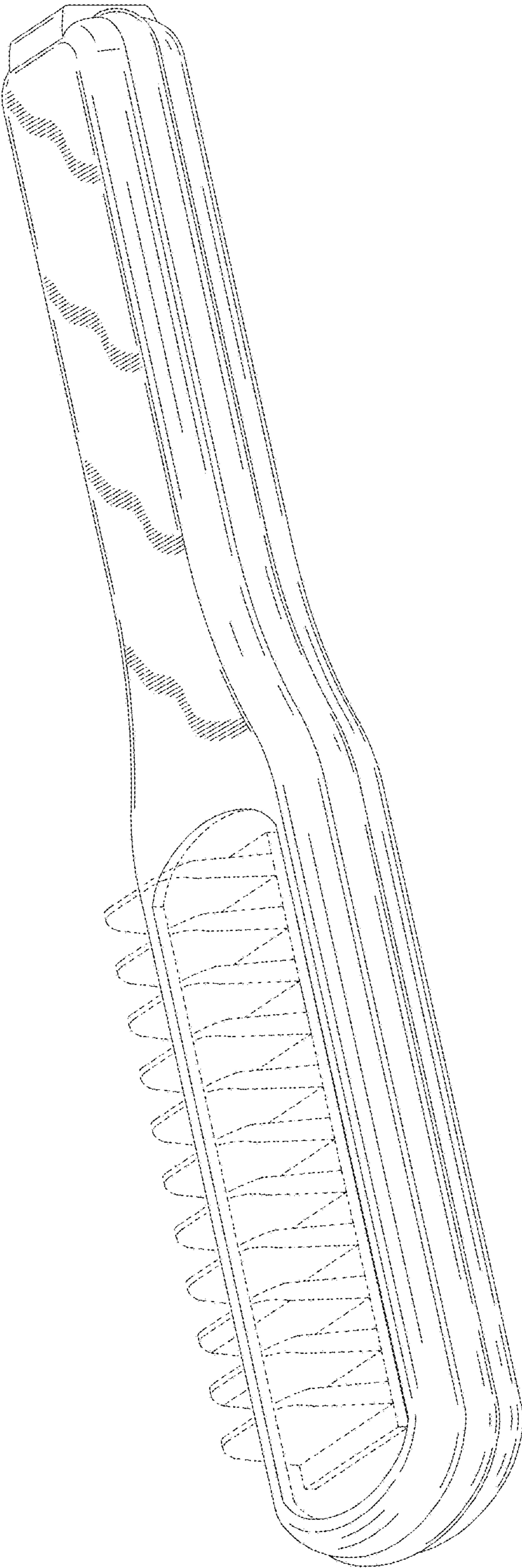

FIG.1

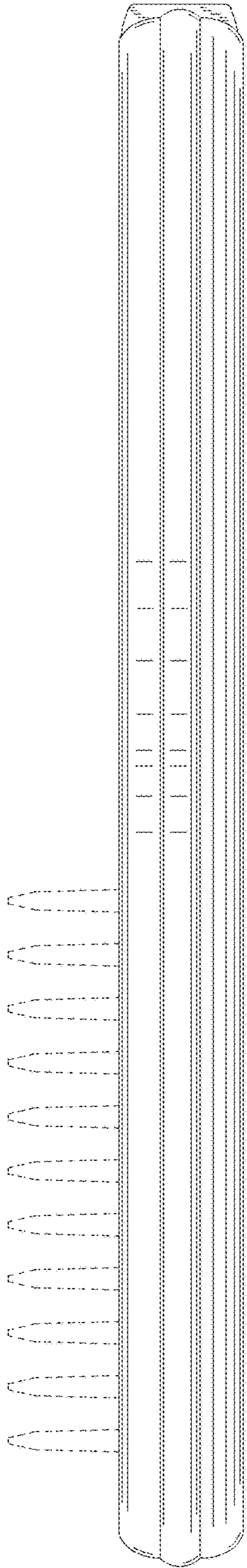

FIG. 2

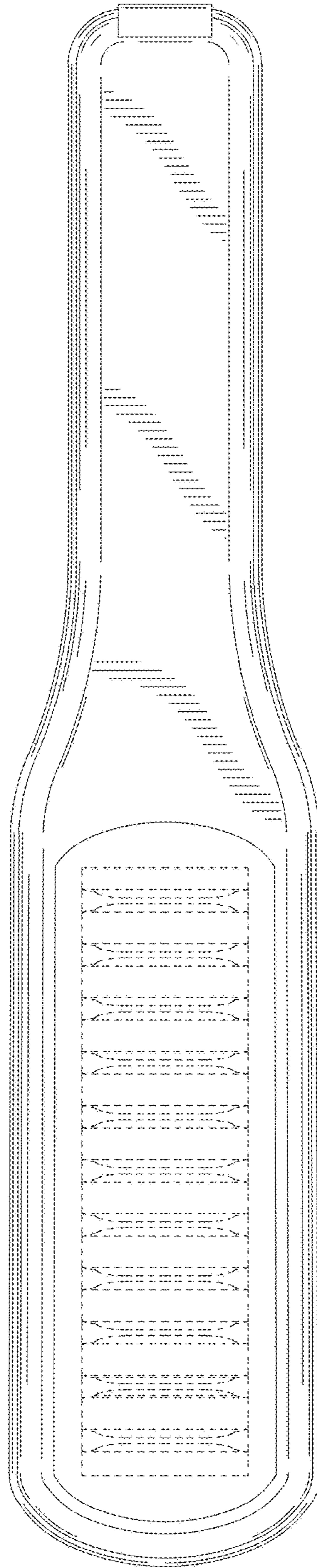

FIG. 3

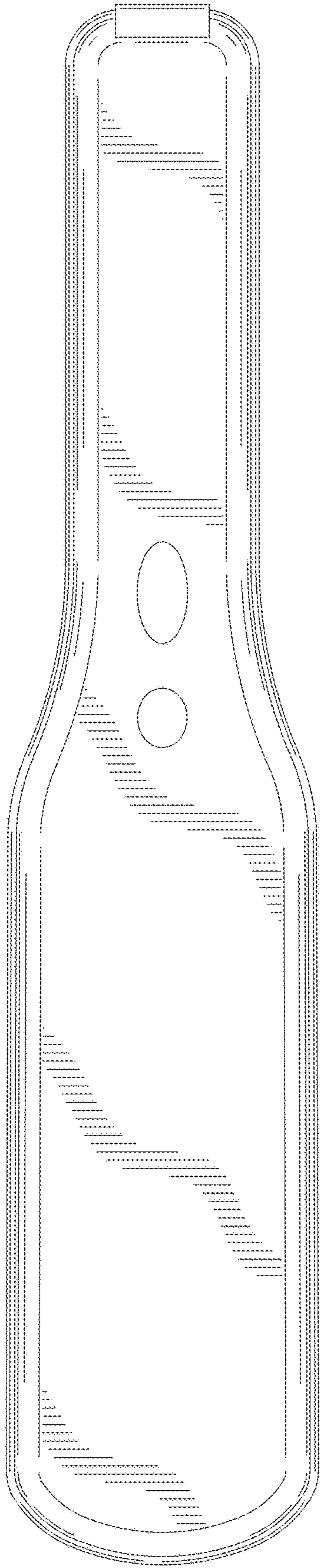

FIG. 4

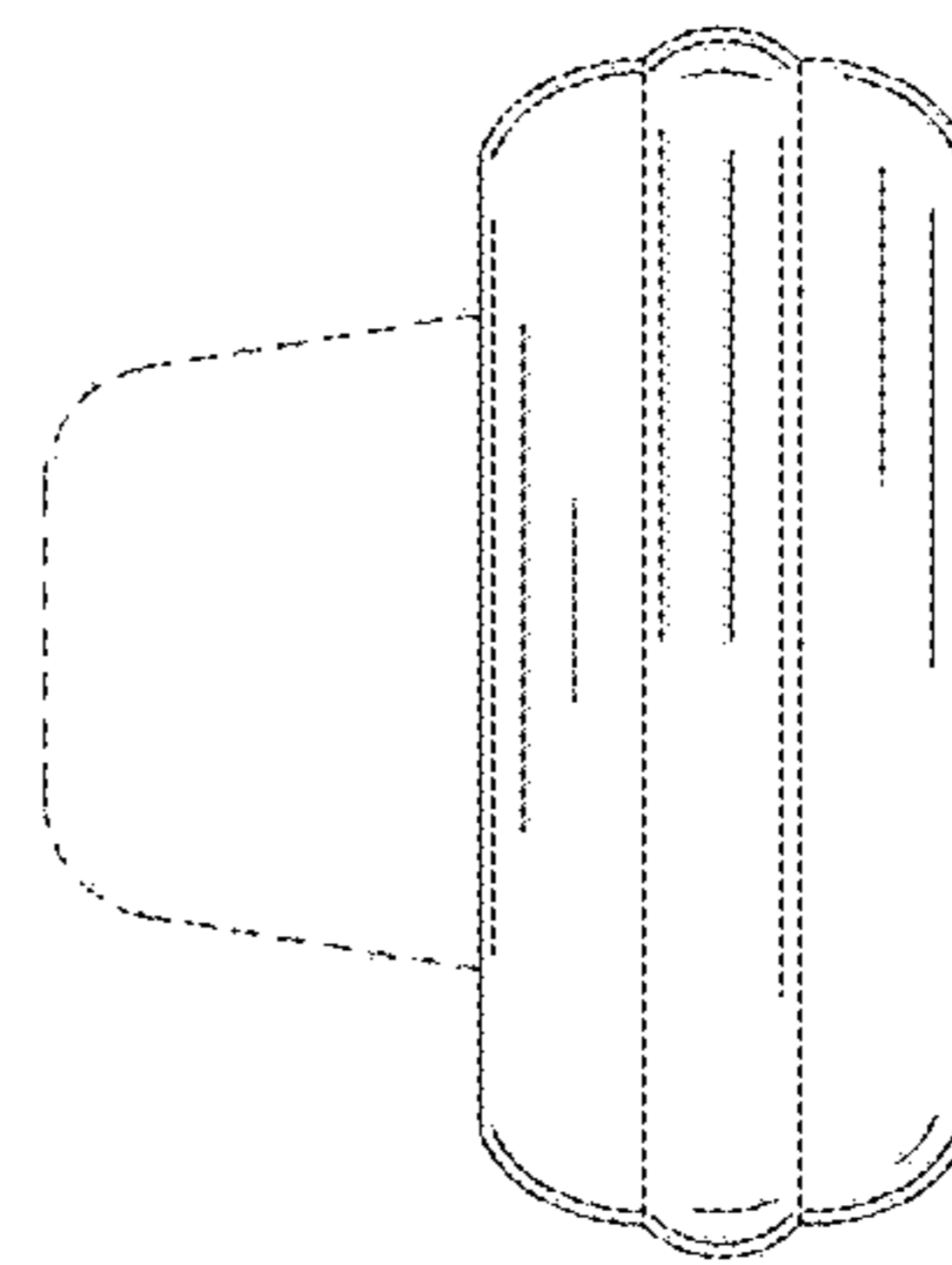

FIG. 5

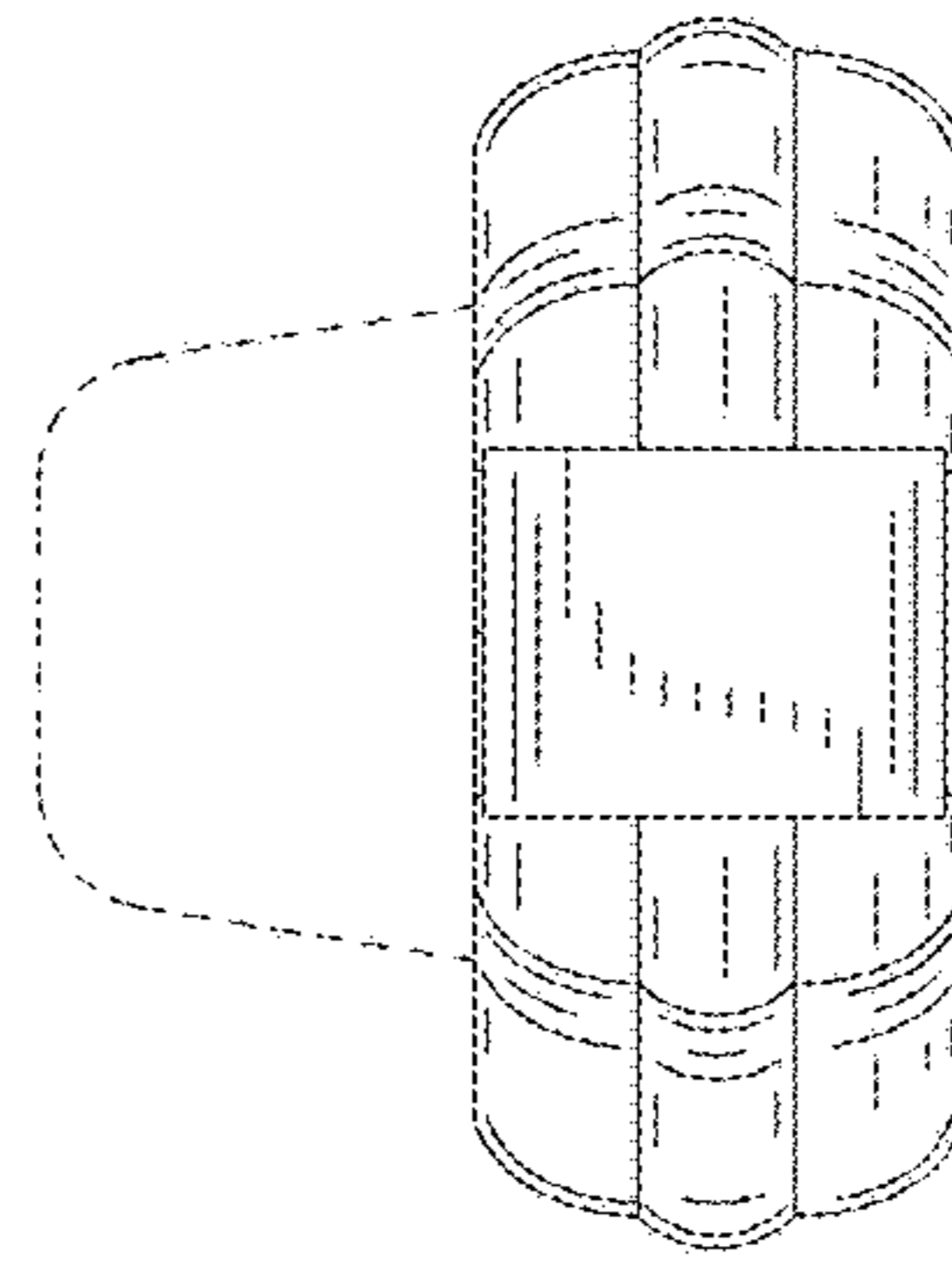

FIG. 6