

US00D832582S

(12) **United States Design Patent** (10) **Patent No.:** **US D832,582 S**
Lee et al. (45) **Date of Patent:** **** Nov. 6, 2018**

(54) **BINOCULAR CASE** D431,356 S * 10/2000 Ammerman D3/216
D762,059 S * 7/2016 Klot D3/217

(71) Applicant: **NIKON INC.**, Melville, NY (US) * cited by examiner

(72) Inventors: **David C. Lee**, New Fairfield, CT (US);
Jeffrey Hunter, Shoreman, NY (US);
Randy A. Garrison, Northpoint, NY (US)
Primary Examiner — Holly H Baynham
(74) *Attorney, Agent, or Firm* — Oliff PLC

(73) Assignee: **NIKON INC.**, Melville, NY (US) (57) **CLAIM**

(**) Term: **15 Years** The ornamental design for a binocular case, as shown and described.

(21) Appl. No.: **29/623,501**

(22) Filed: **Oct. 25, 2017**

(51) **LOC (11) Cl.** **03-01**

(52) **U.S. Cl.**
USPC **D3/318**; D3/216

(58) **Field of Classification Search**
USPC D3/216–217, 244, 318
CPC A45F 4/02; A45F 3/04; A45C 7/00; A45C
9/00

See application file for complete search history.

(56) **References Cited**

U.S. PATENT DOCUMENTS

D402,107 S * 12/1998 Allison D3/217

DESCRIPTION

FIG. 1 is a front, top, left-side perspective view of the binocular case;
FIG. 2 is a front elevational view thereof;
FIG. 3 is a top plan view thereof;
FIG. 4 is a right-side elevational view thereof;
FIG. 5 is a left-side elevational view thereof;
FIG. 6 is a rear elevational view thereof; and,
FIG. 7 is a front, top, left-side perspective view thereof in an open state.
The broken lines depict unclaimed parts of the binocular case, and thus form no part of the claimed design.

1 Claim, 6 Drawing Sheets

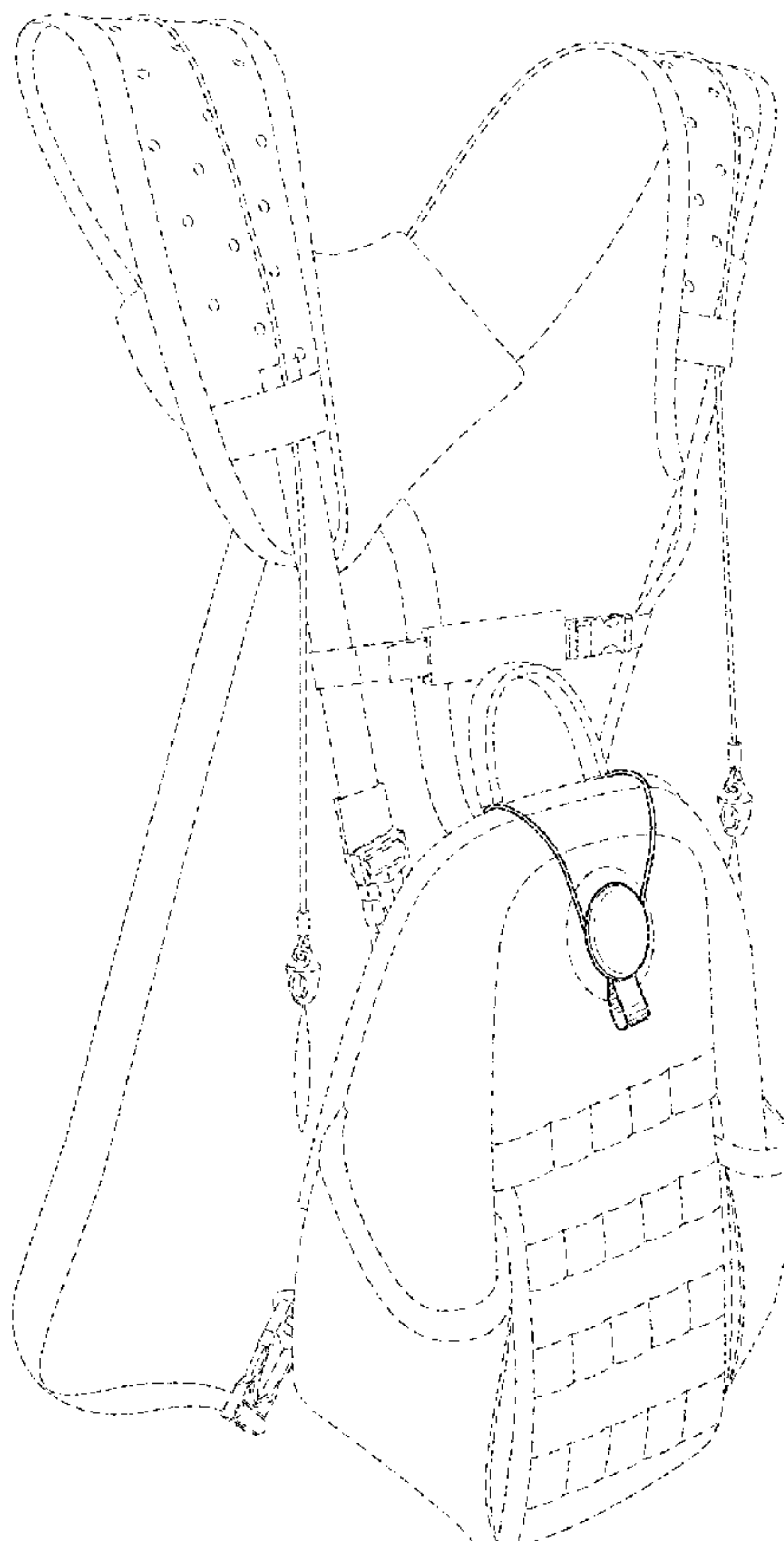

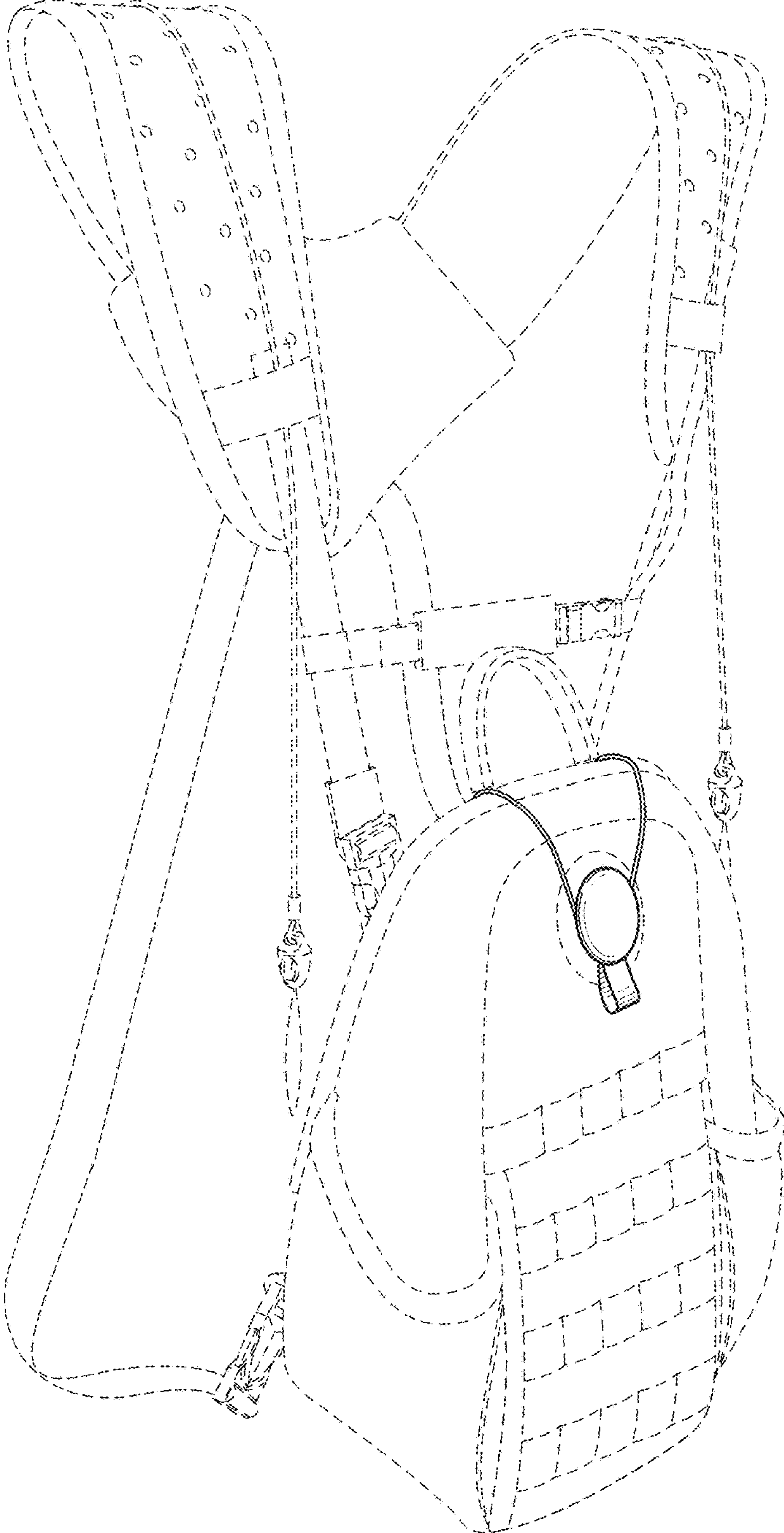

FIG. 1

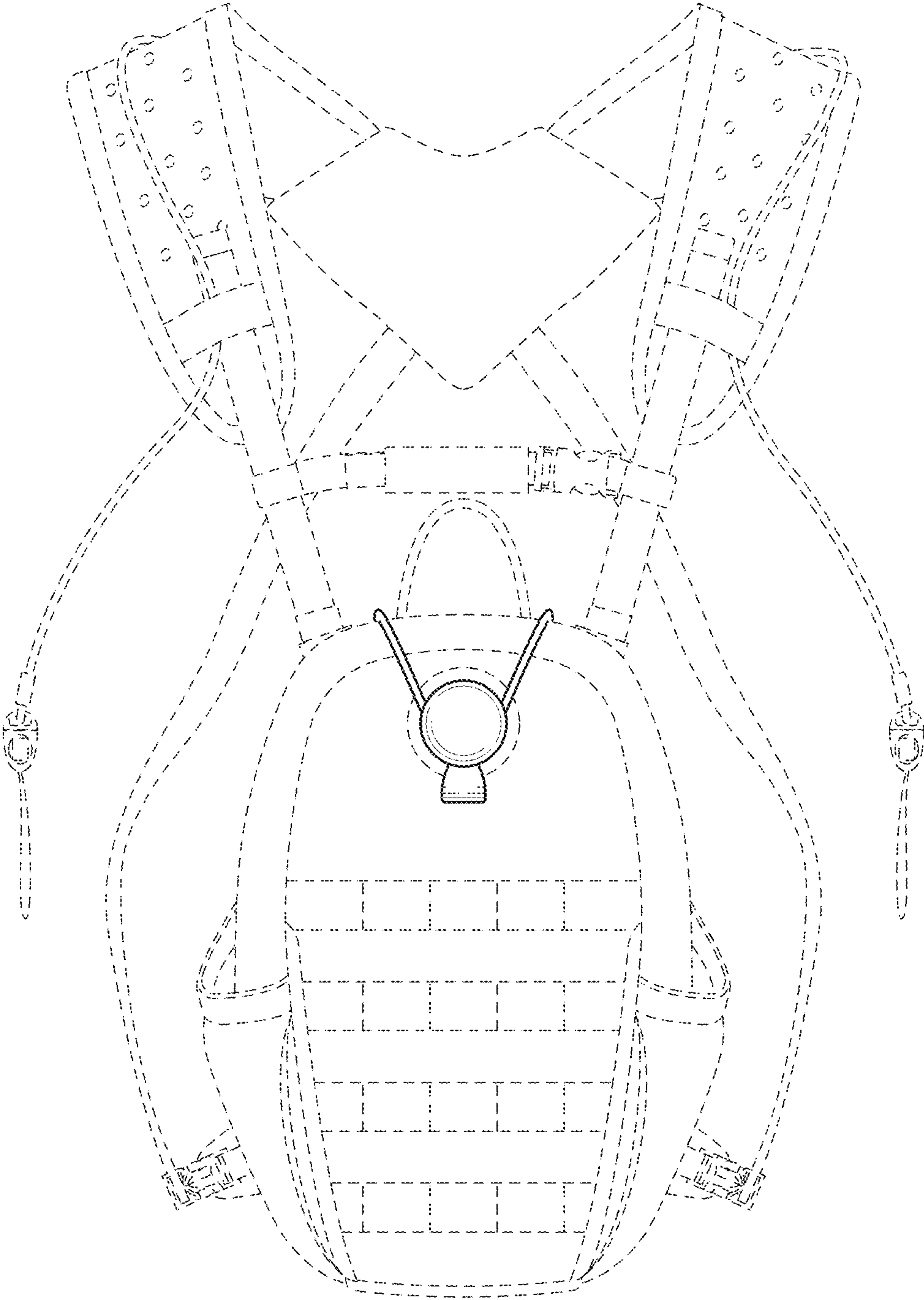

FIG. 2

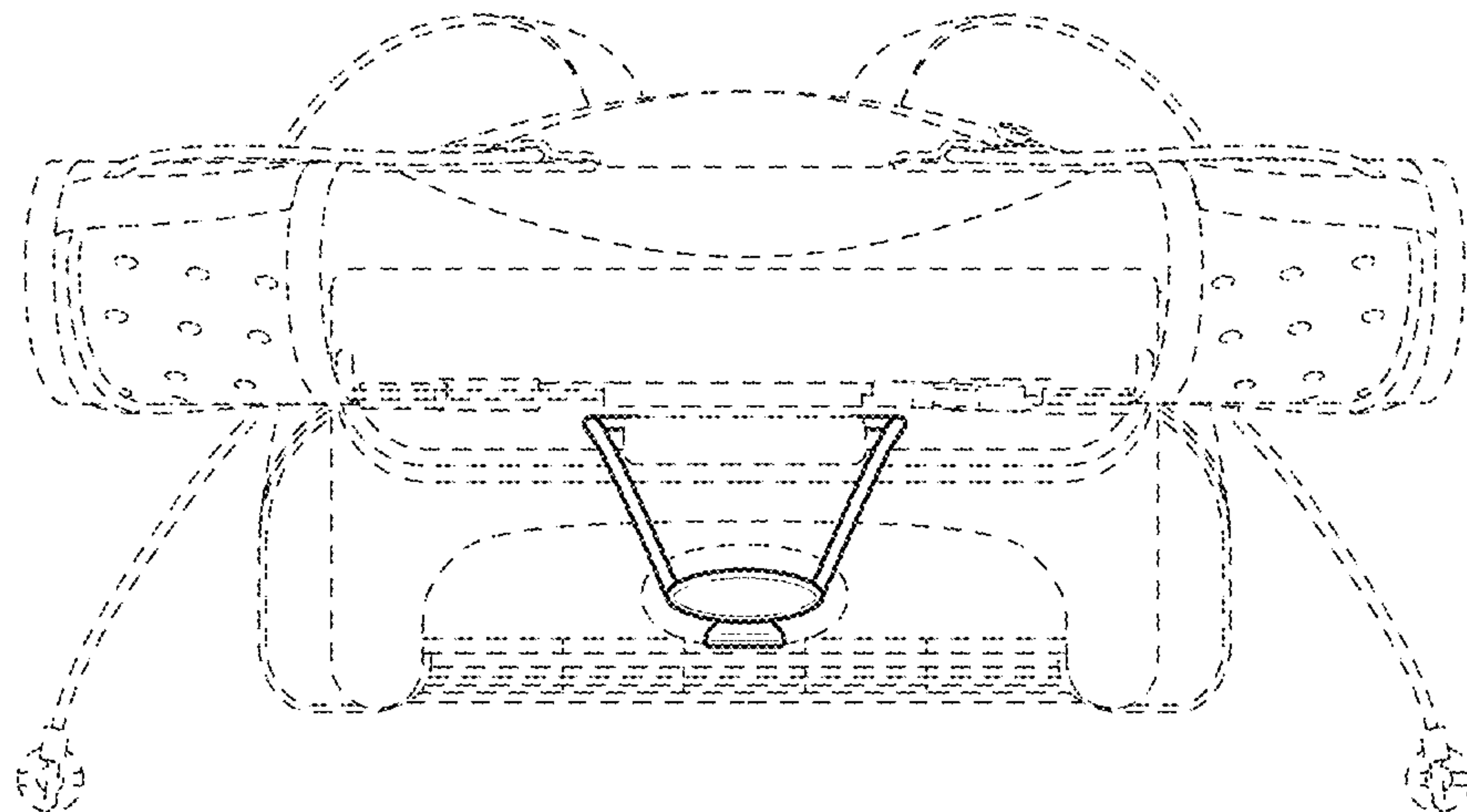

FIG. 3

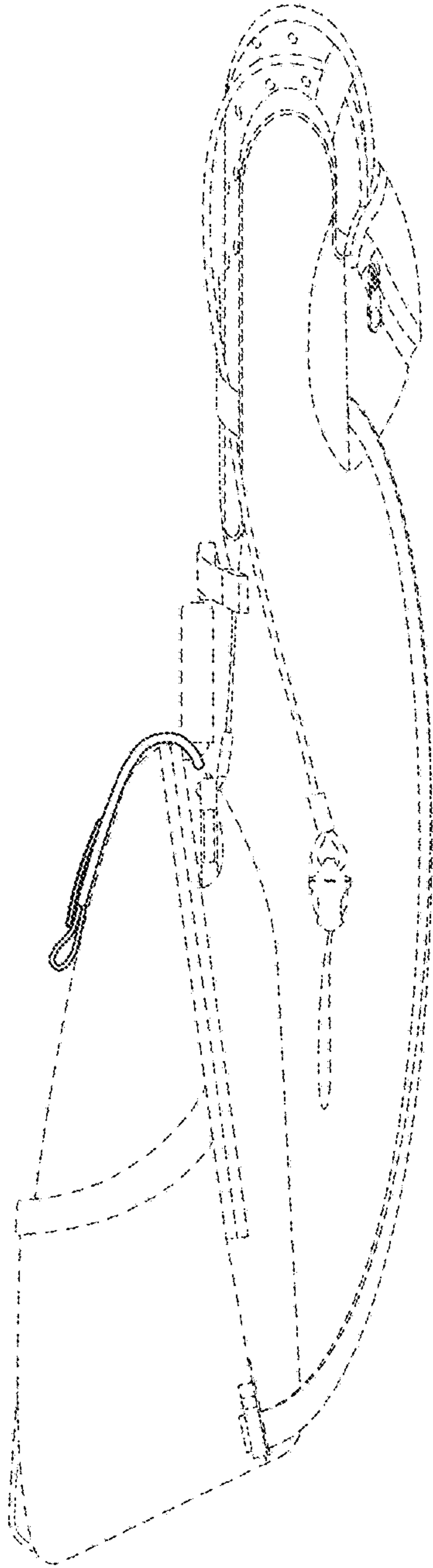

FIG. 4

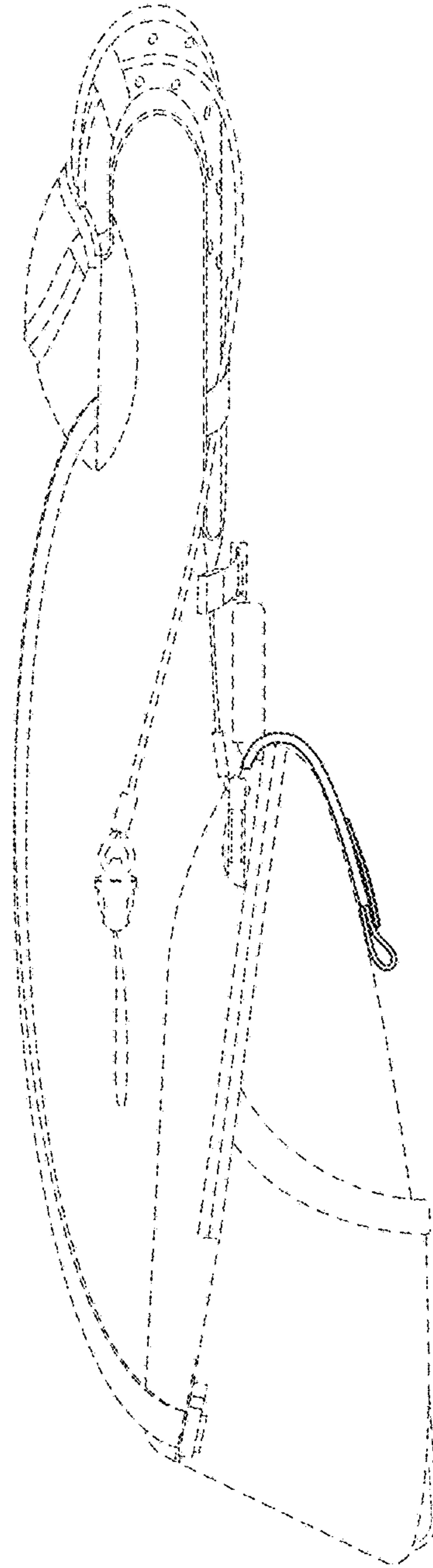

FIG. 5

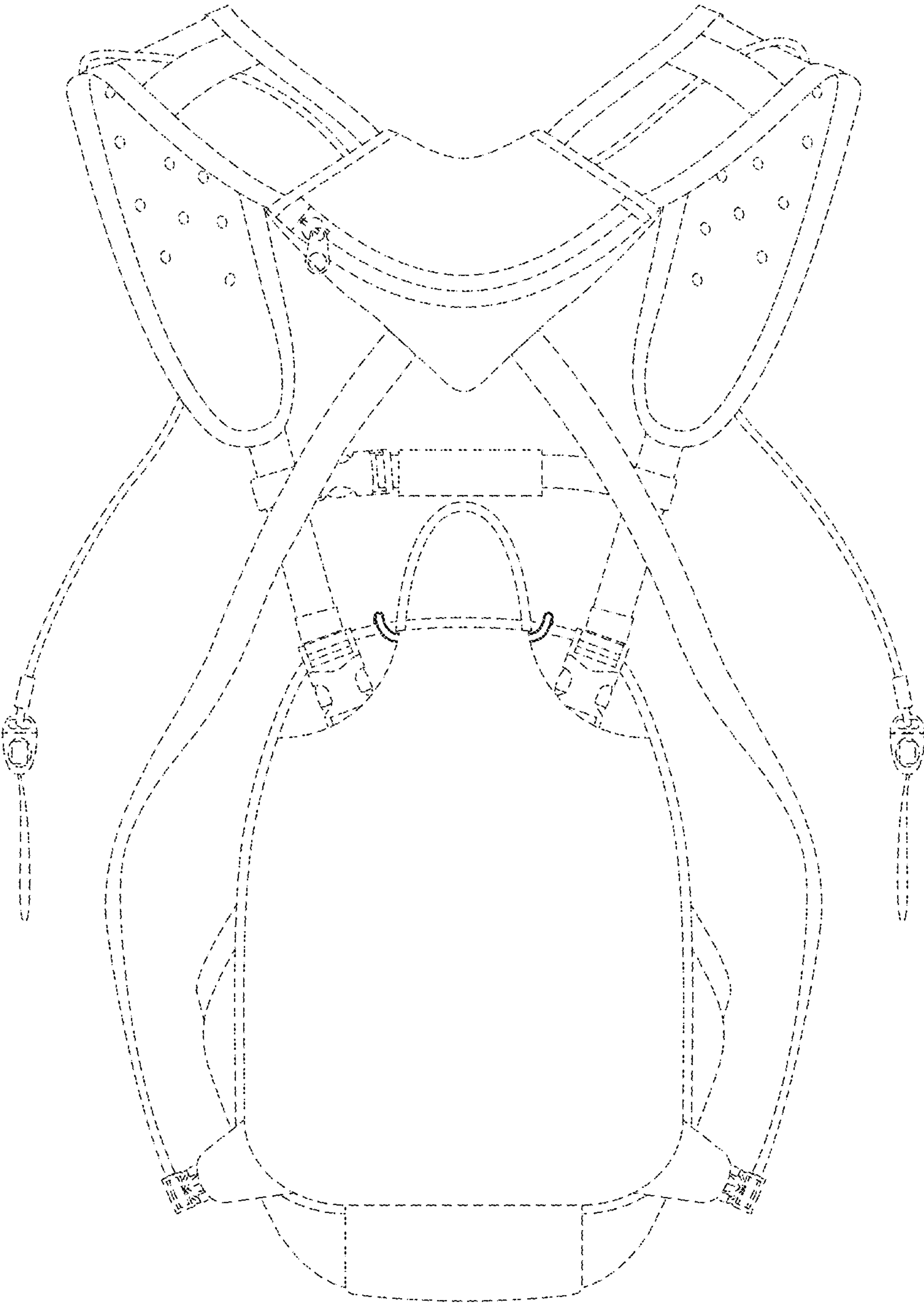

FIG. 6

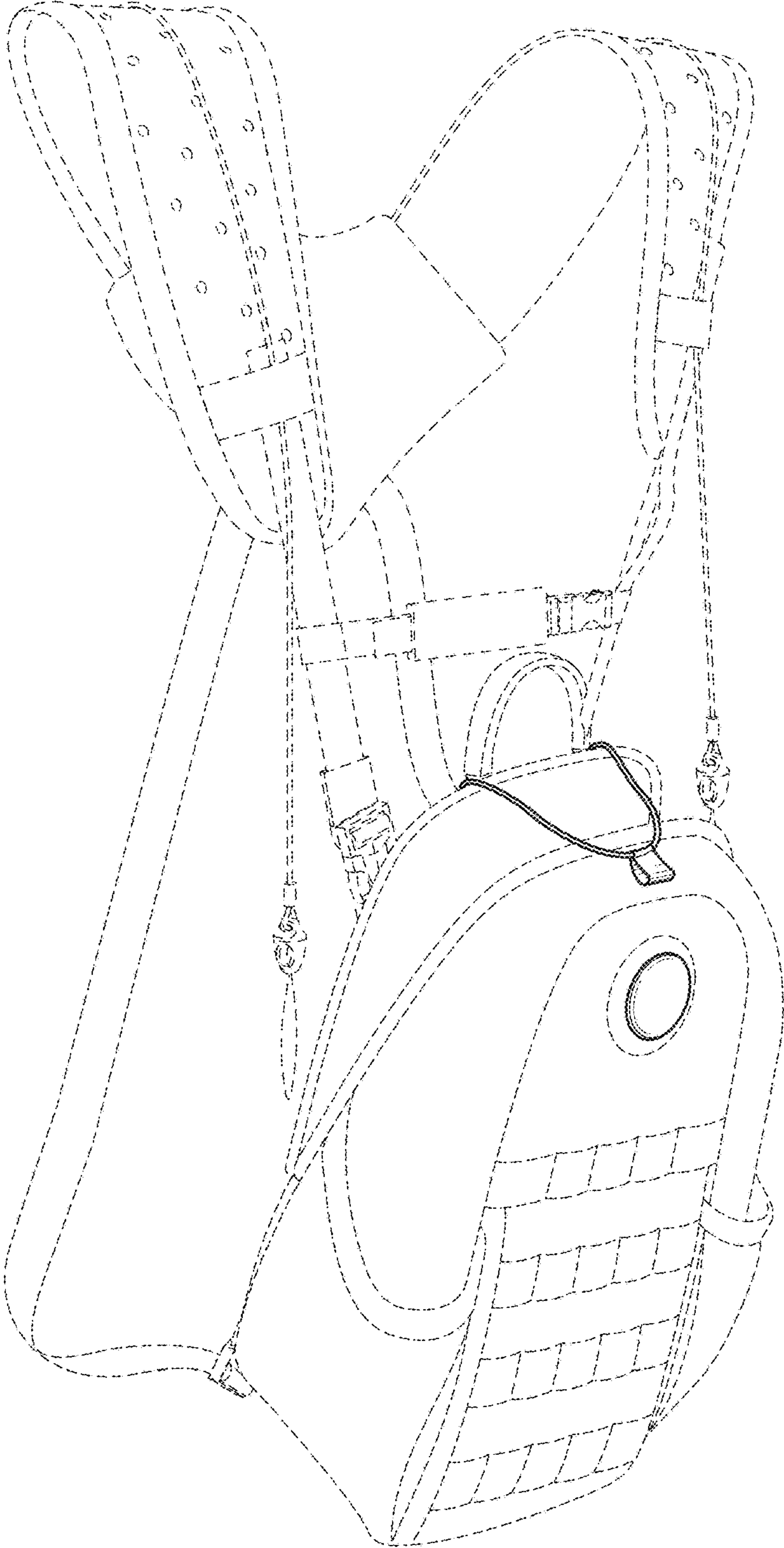

FIG. 7