



US00D832566S

(12) **United States Design Patent** (10) **Patent No.:** **US D832,566 S**
Kuerbis (45) **Date of Patent:** **** Nov. 6, 2018**

(54) **SHOE UPPER**

(71) Applicant: **NIKE, Inc.**, Beaverton, OR (US)

(72) Inventor: **Tate E. Kuerbis**, Portland, OR (US)

(73) Assignee: **NIKE, Inc.**, Beaverton, OR (US)

(**) Term: **15 Years**

(21) Appl. No.: **29/600,686**

(22) Filed: **Apr. 14, 2017**

(51) **LOC (11) Cl.** **02-99**

(52) **U.S. Cl.**
USPC **D2/972**

(58) **Field of Classification Search**
USPC D2/902, 906-908, 923, 944, 946, 969,
D2/972-975, 978; D5/46, 47, 49, 53
CPC ... A43B 13/181; A43B 13/141; A43B 13/186;
A43B 13/188; A43B 23/00; A43B 23/02;
A43B 5/00; A43B 23/26; A43B 1/04;
A43B 11/14; A43B 7/00; A43B 3/12;
A43C 3/00; A43C 5/00; A43C 7/00;
A43C 11/004

See application file for complete search history.

(56) **References Cited**

U.S. PATENT DOCUMENTS

D283,366 S *	4/1986	Chassaing	D2/902
D296,721 S *	7/1988	Brown	D2/973
D297,591 S *	9/1988	Brown	D2/973
D297,781 S *	9/1988	Diaz	D2/973
D369,897 S *	5/1996	Worthington	D2/969
D444,624 S *	7/2001	Wilson	D2/902
D466,683 S *	12/2002	Chen	D2/907
D473,702 S *	4/2003	Burg	D2/969
D476,471 S *	7/2003	Alfaro	D2/972
D513,362 S *	1/2006	Kuerbis	D2/972
D534,342 S *	1/2007	Minami	D2/972
D536,519 S *	2/2007	Caine	D2/969
D574,581 S *	8/2008	Cooper	D2/902

D662,301 S *	6/2012	Raysse	D2/969
D767,871 S	10/2016	Avar	
D769,604 S *	10/2016	Mueller	D2/972
D779,187 S	2/2017	Williams, Jr.	
D781,563 S *	3/2017	Chang	D2/972
D790,832 S *	7/2017	Fogg	D2/972
D793,069 S *	8/2017	Jury	D2/972
D815,421 S *	4/2018	Sokol	D2/972
D816,974 S *	5/2018	Hernandez	D2/972

OTHER PUBLICATIONS

The Complete History of the Air Jordan 1—XX8 [online], [retrieved Mar. 27, 2017], Retrieved from Internet <URL: <http://www.complex.com/sneakers/2013/07/air-jordan-complete-history-from-i-xx8/air-jordan-xx8>>; 30 color sheets, Dated Jul. 1, 2013.

(Continued)

Primary Examiner — Dominic V Simone
(74) *Attorney, Agent, or Firm* — Banner & Witcoff, Ltd.

(57) **CLAIM**

The ornamental design for a shoe upper, as shown and described.

DESCRIPTION

FIG. 1 is a side view of a shoe upper showing my new design;
FIG. 2 is a rear perspective view thereof;
FIG. 3 is a rear view thereof;
FIG. 4 is a second rear perspective view thereof; and,
FIG. 5 is an opposite side view thereof.
The broken lines immediately adjacent to the shaded area define the bounds of the claimed design and form no part thereof. The four unshaded regions within the shaded area that are demarcated by broken lines form no part of the claimed design. The broken lines showing the remainder of the shoe represent unclaimed subject matter and form no part of the claimed design.

1 Claim, 5 Drawing Sheets

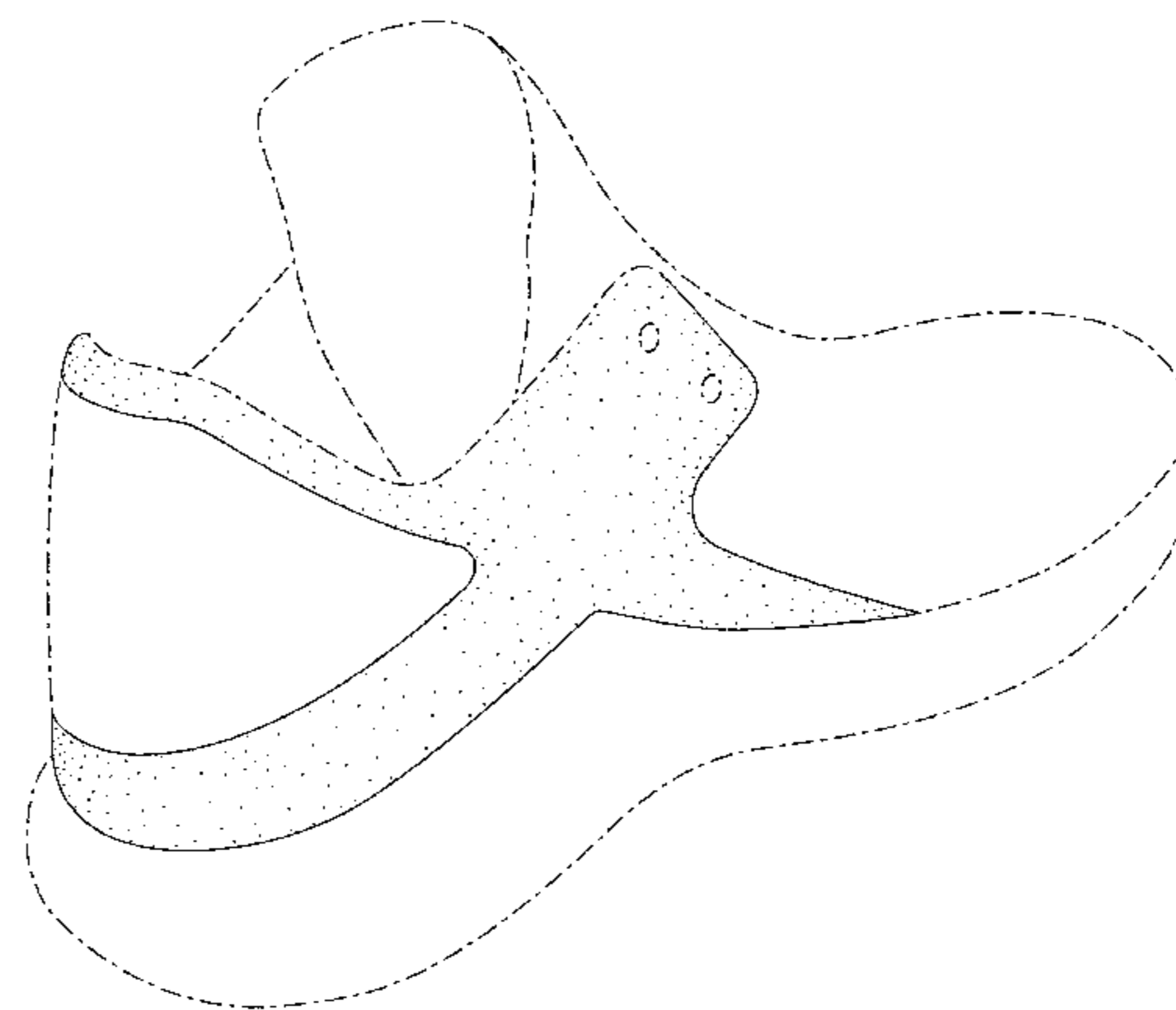
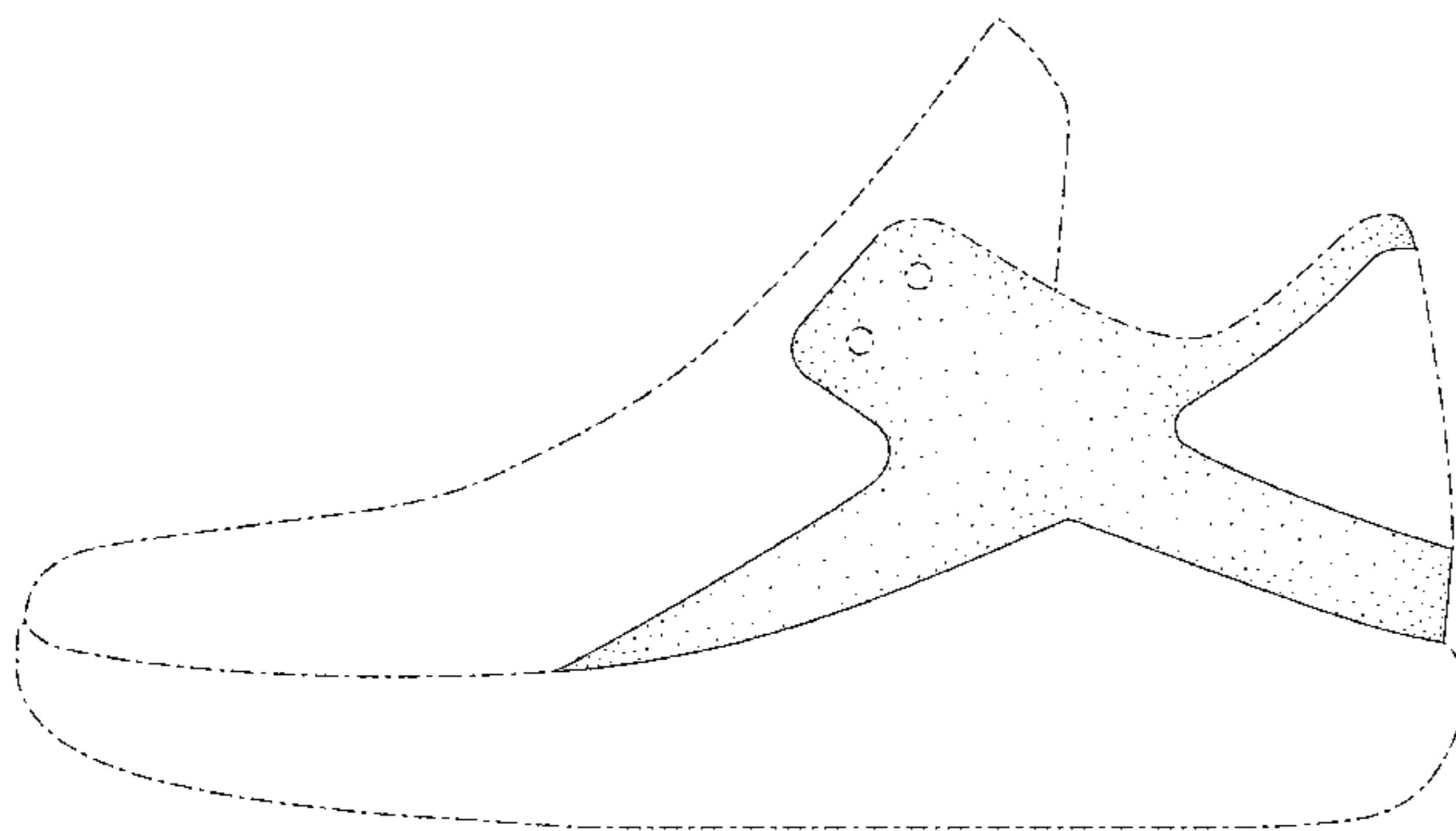

(56)

References Cited

OTHER PUBLICATIONS

Leo S. Chang on “The Signature Shoe of Nike Basketball” [online], [retrieved Mar. 27, 2017], Retrieved from Internet <URL: <http://news.nike.com/news/hyperdunk-2016-nikelab>>; 12 color sheets, Dated Jun. 27, 2016.

Introducing the Nike Hyperdunk 2017[online], [retrieved Mar. 27, 2017], Retrieved from Internet <URL: <https://solecollector.com/news/2017/03/nike-hyperdunk-2017-release-date-897808>>; 7 color sheets, Dated Mar. 12, 2017.

* cited by examiner

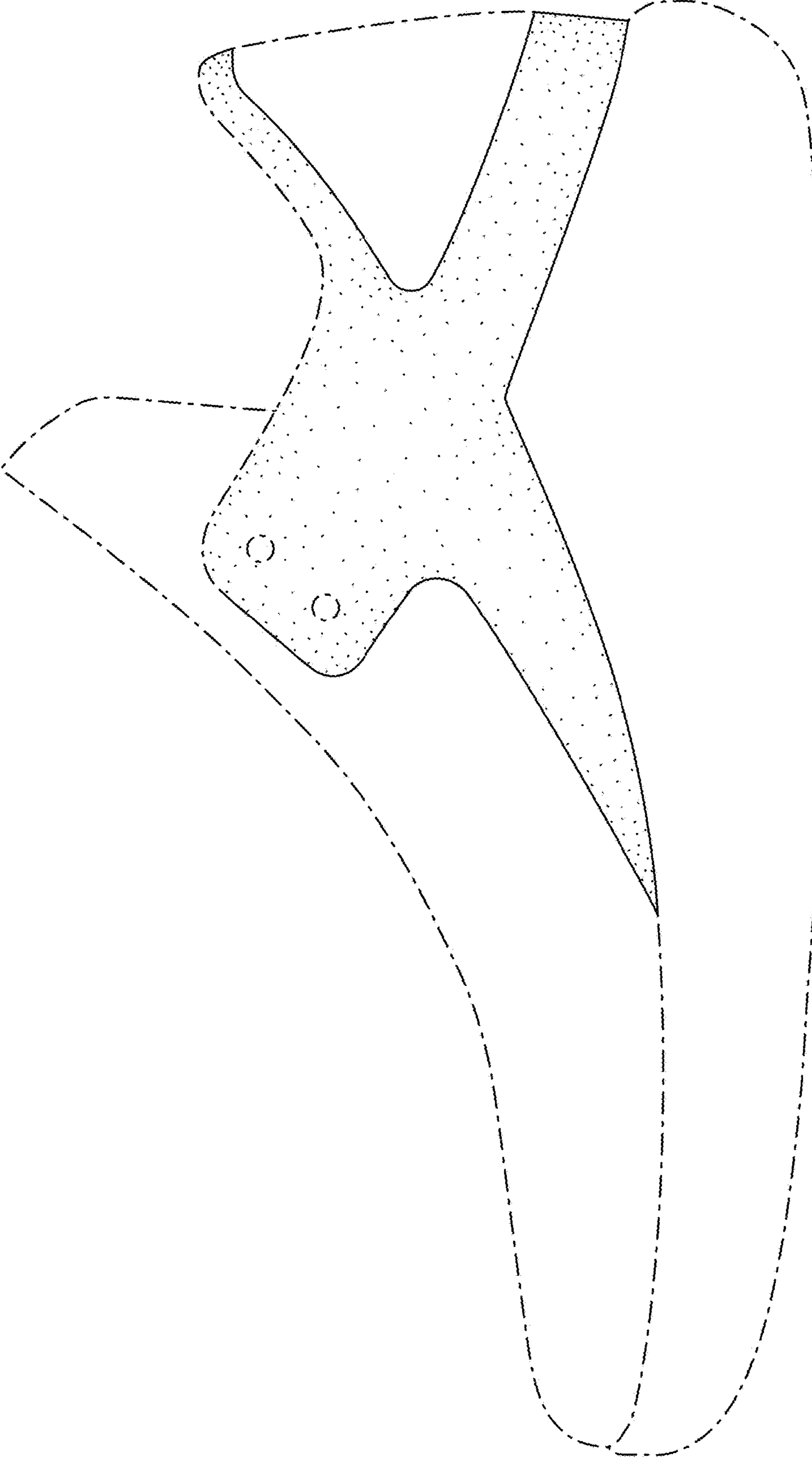

FIG. 1

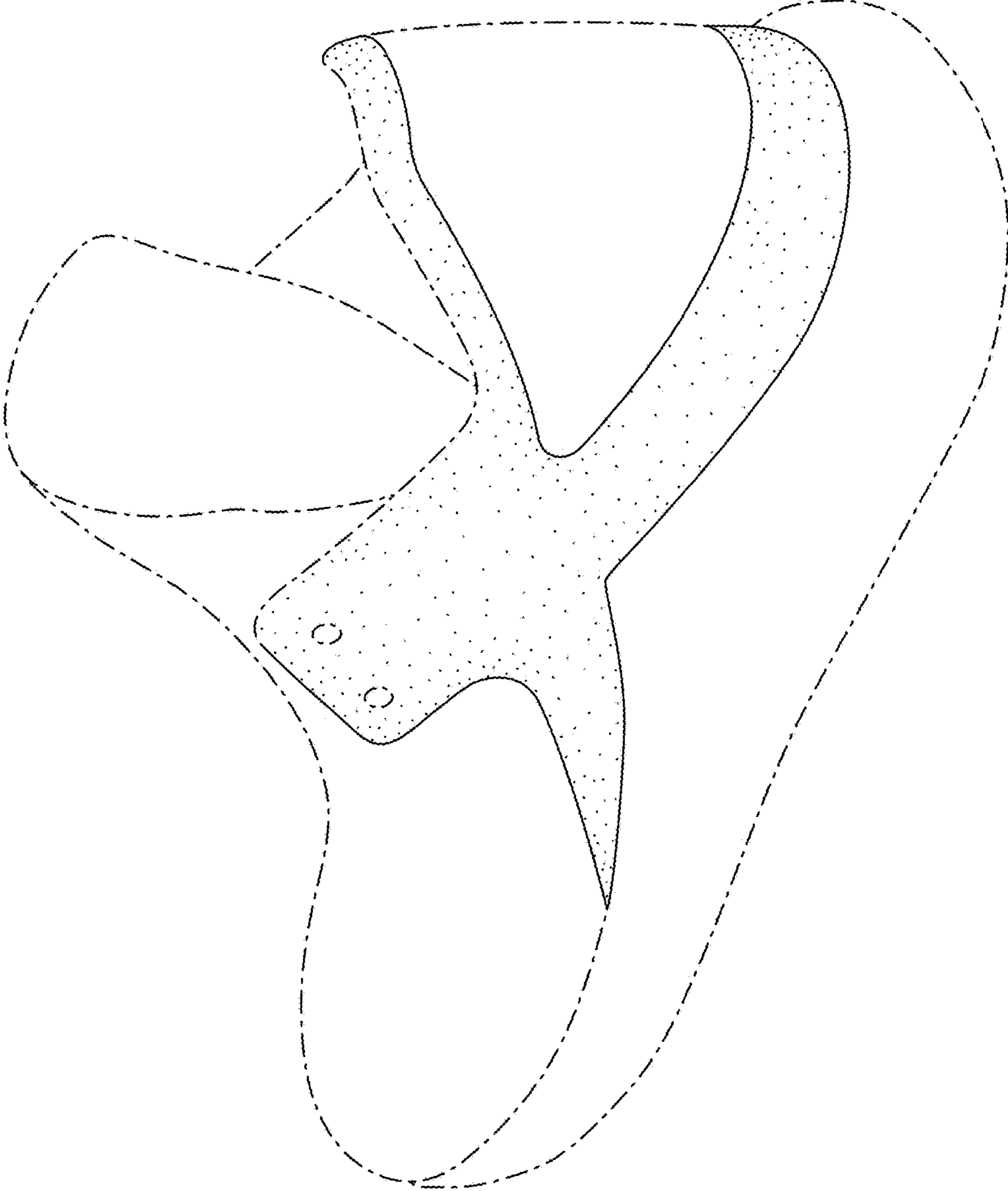

FIG. 2

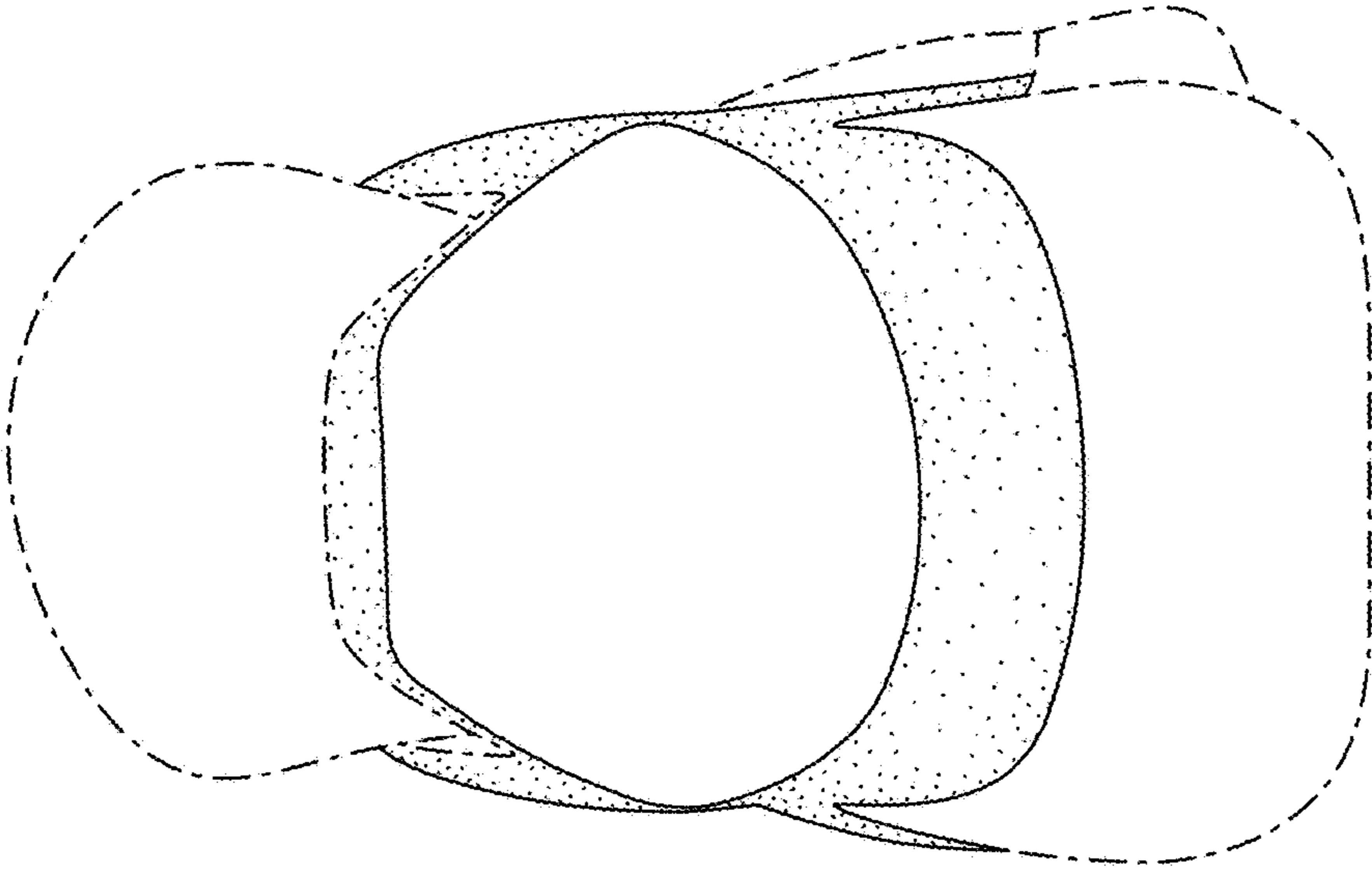

FIG. 3

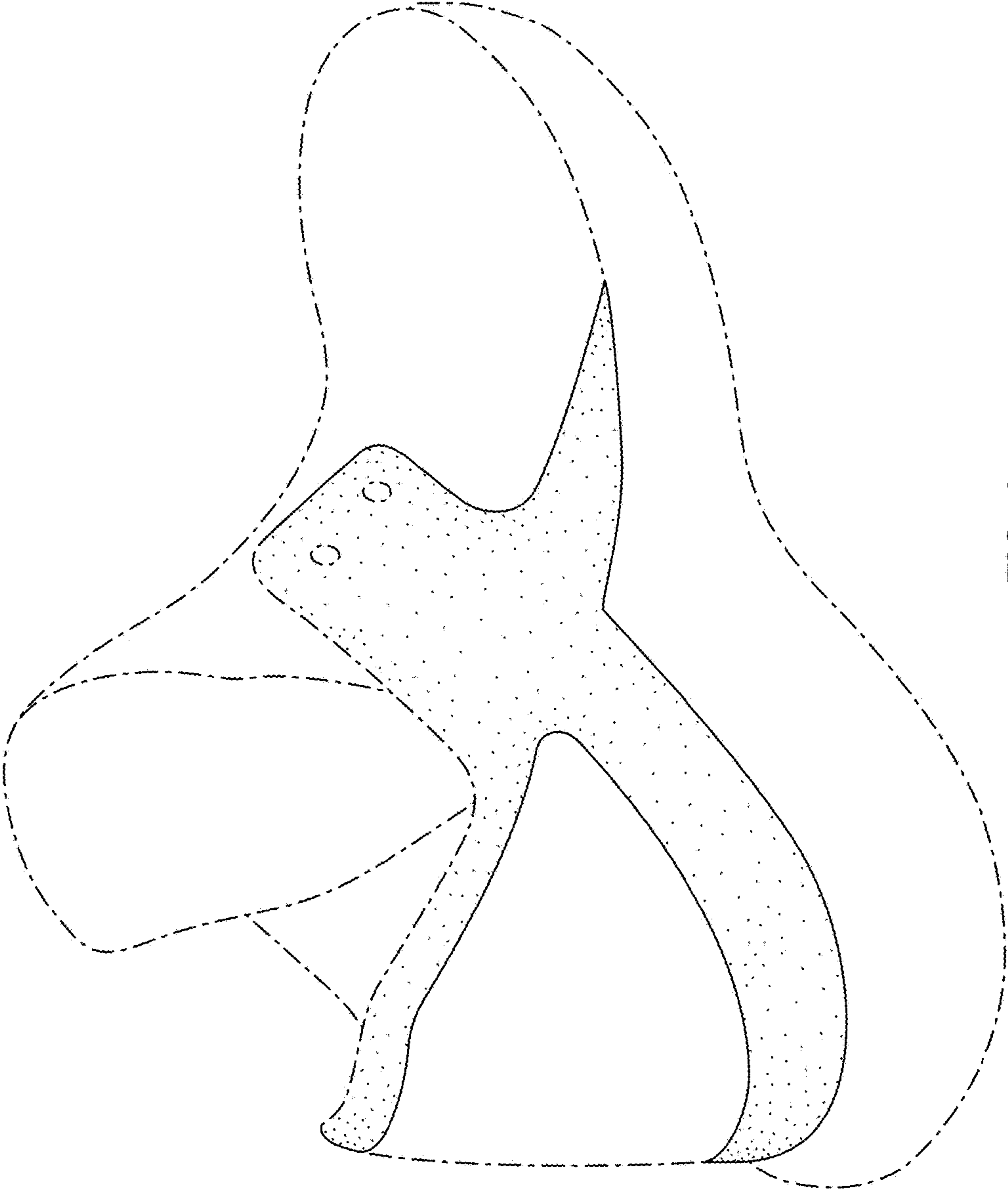

FIG. 4

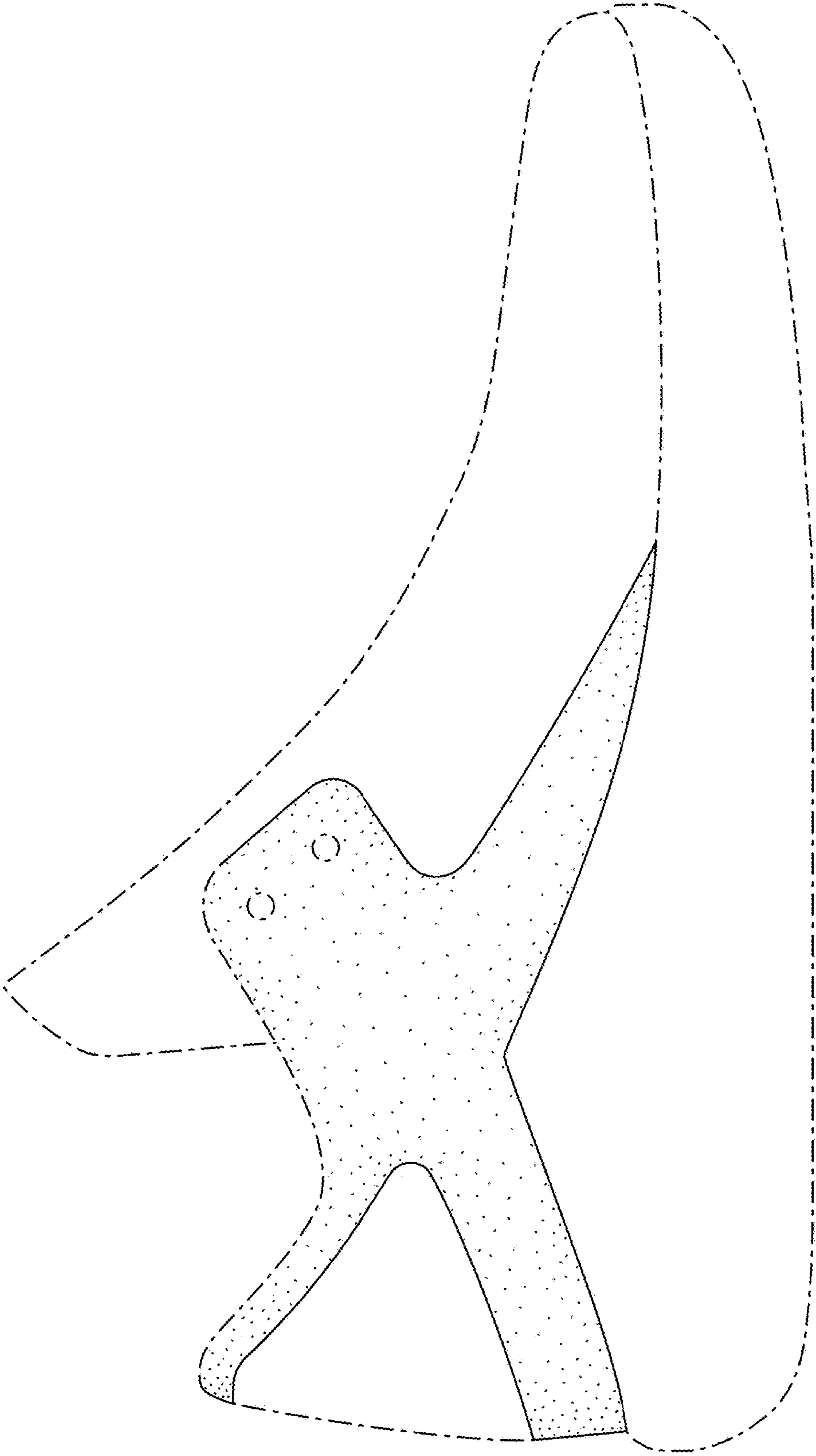

FIG. 5