

US00D832526S

(12) **United States Design Patent**  
**Stobar**

(10) **Patent No.:** **US D832,526 S**

(45) **Date of Patent:** **\*\* \*Oct. 30, 2018**

(54) **KNEEPAD**

(71) Applicant: **JS Products, Inc.**, Las Vegas, NV (US)

(72) Inventor: **James K. Stobar**, Los Angeles, CA (US)

(73) Assignee: **JS Products, Inc.**, Las Vegas, NV (US)

(\*) Notice: This patent is subject to a terminal disclaimer.

(\*\*) Term: **15 Years**

(21) Appl. No.: **29/560,250**

(22) Filed: **Apr. 4, 2016**

(51) **LOC (11) Cl.** ..... **29-02**

(52) **U.S. Cl.**  
USPC ..... **D29/121.1**

(58) **Field of Classification Search**

USPC ..... D29/121.1, 100, 115, 116.3, 120.1, 122;  
D2/711, 713; 128/95.1, 96.1, 98.1, 846,  
128/891; 602/67, 72, 73, 96, 108, 114;  
2/2, 455; 450/38, 228, 267, 403, 405;  
623/7; 604/352, 353, 395

CPC ..... A41D 13/05; A41D 13/0525; A63B 71/08  
See application file for complete search history.

(56) **References Cited**

**U.S. PATENT DOCUMENTS**

D377,851 S \* 2/1997 Dancyger ..... D29/121.1  
D380,876 S \* 7/1997 Campbell ..... D29/121.1

D466,254 S \* 11/2002 Hung ..... D29/121.1  
D594,161 S \* 6/2009 Worden ..... D29/121.1  
D602,209 S \* 10/2009 Cheung ..... D29/121.1  
D717,499 S \* 11/2014 Stauber ..... D29/121.1  
D732,749 S \* 6/2015 Vito ..... D29/121.1  
D741,552 S \* 10/2015 Vito ..... D29/121.1

\* cited by examiner

*Primary Examiner* — Randall Gholson

(57) **CLAIM**

The ornamental design for a kneepad, as shown and described.

**DESCRIPTION**

FIG. 1 is a first perspective view of a kneepad;  
FIG. 2 is a right side view of the kneepad;  
FIG. 3 is a left side view of the kneepad;  
FIG. 4 is a front view of the kneepad;  
FIG. 5 is a back view of the kneepad;  
FIG. 6 is a top view of the kneepad;  
FIG. 7 is a bottom view of the kneepad; and,  
FIG. 8 is a second perspective view of the kneepad.  
The dashed lines in FIGS. 1-8 are shown for environmental purposes and form no part of the claimed design. The shading lines shown in the drawings represent the approximate three-dimensional contour of the design, and are not intended to indicate surface decoration. All other surface(s) or portion(s) of the design not shown in the figures or otherwise described in the specification form no part of the claimed design.

**1 Claim, 8 Drawing Sheets**

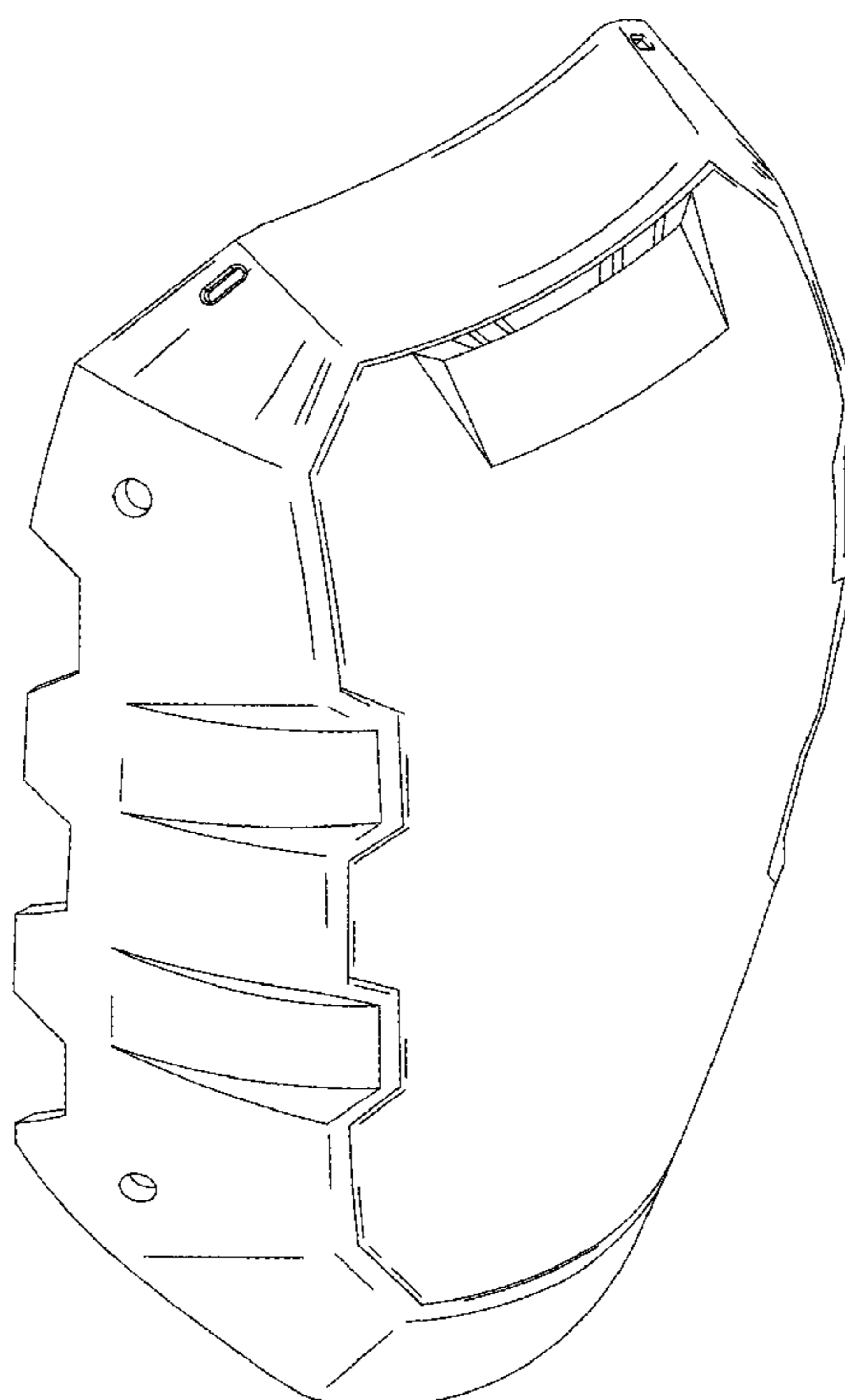

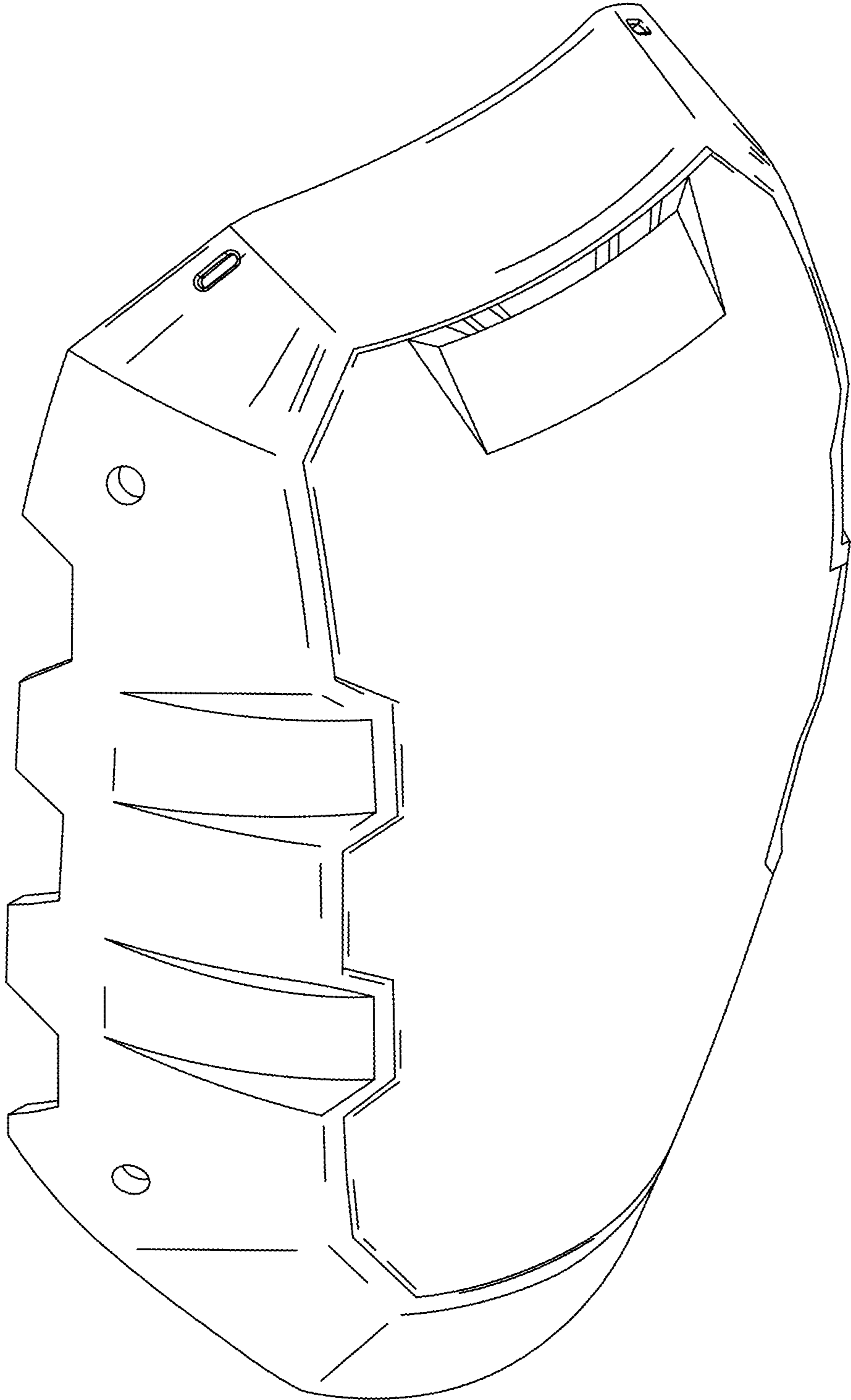

FIG. 1

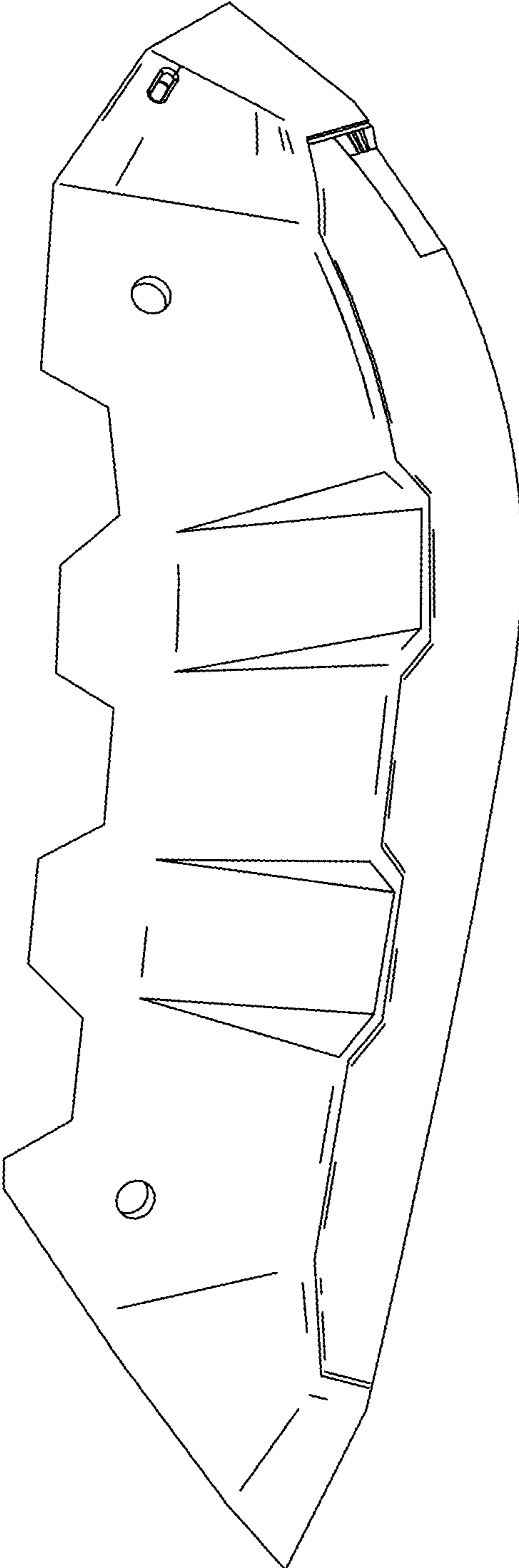

FIG. 2

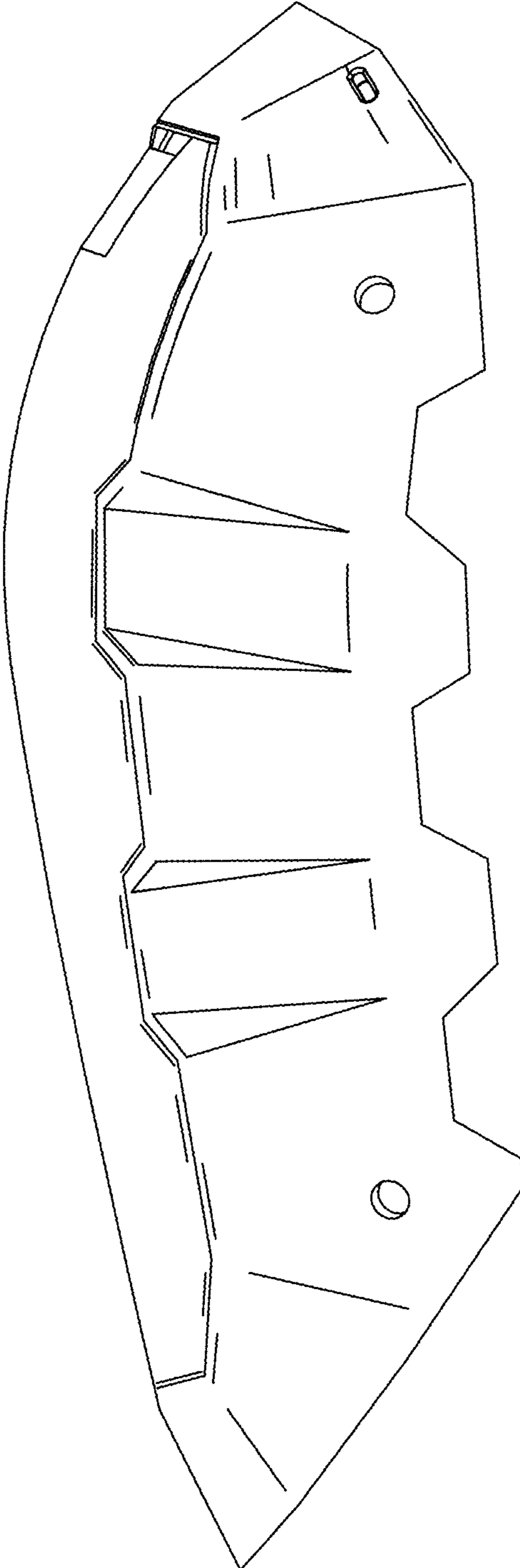

FIG. 3

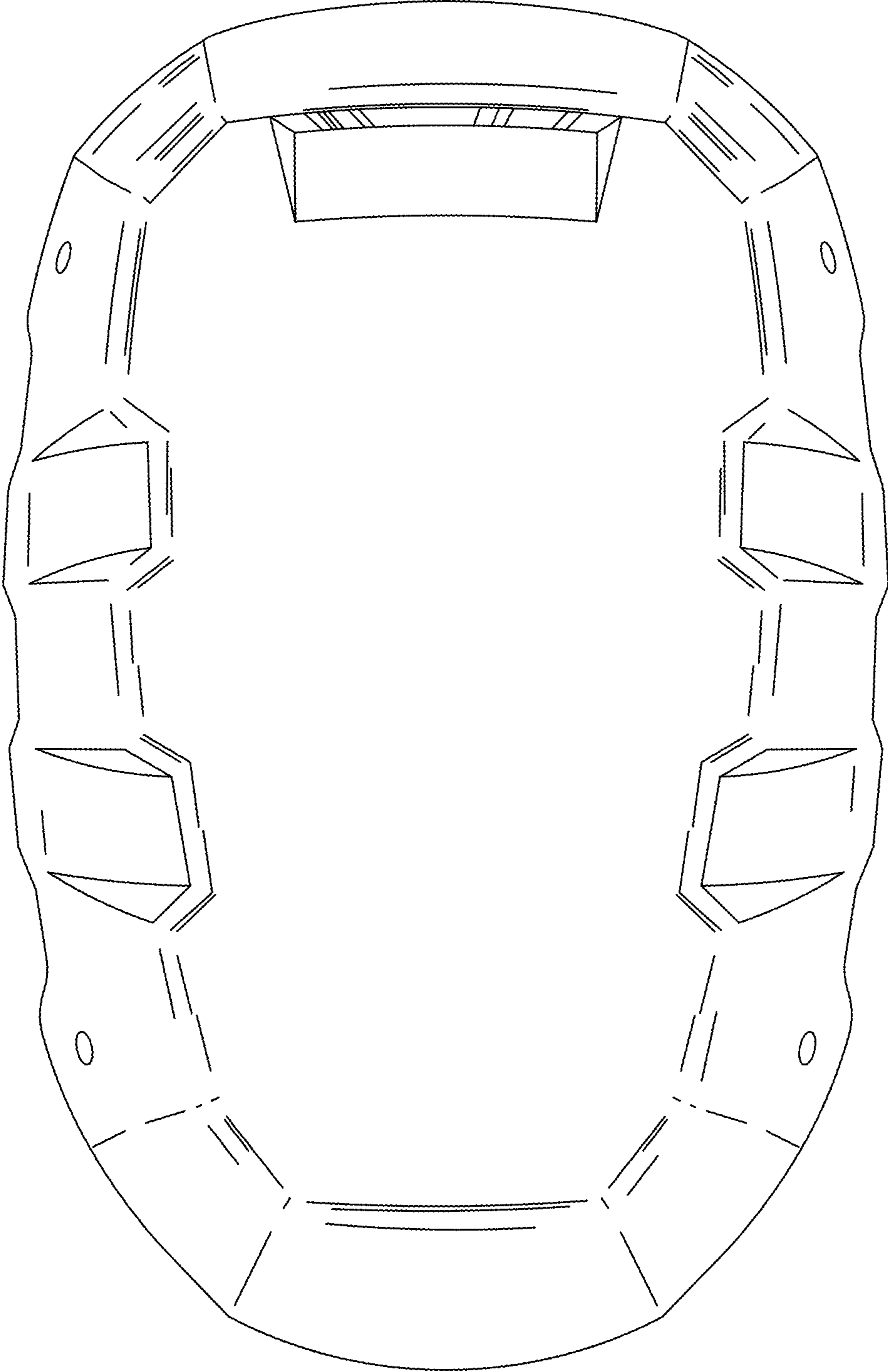

FIG. 4

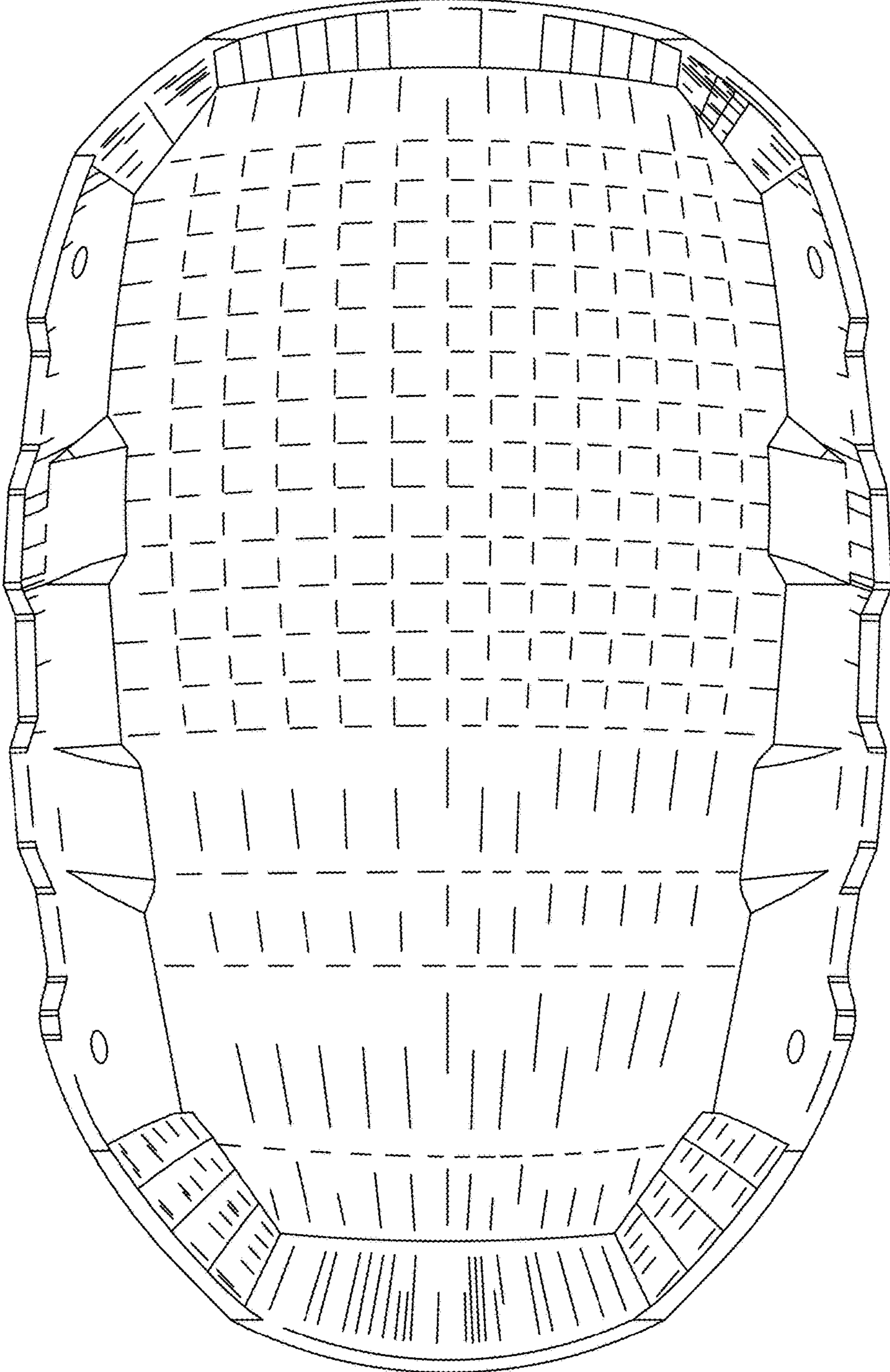

FIG. 5

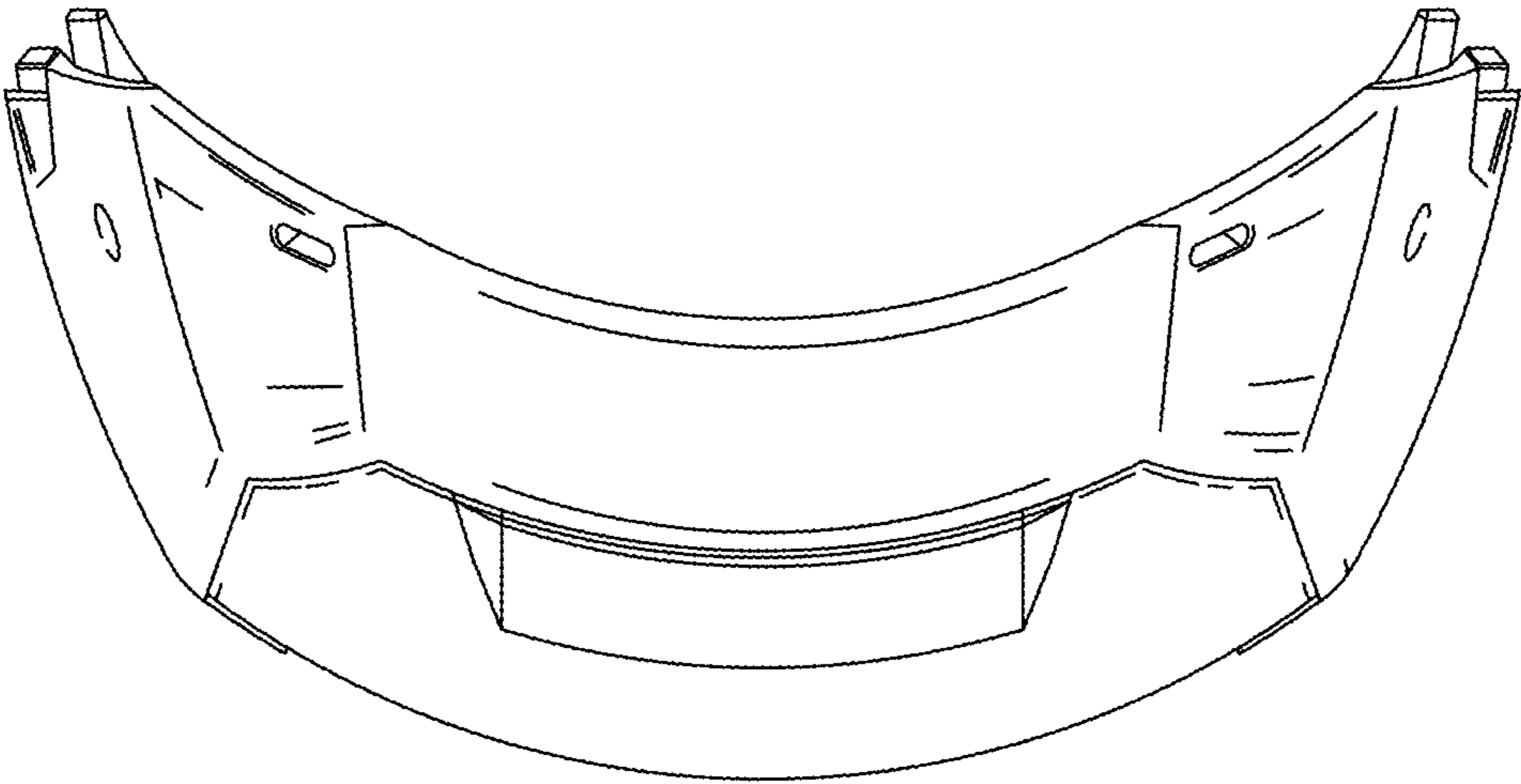

FIG. 6

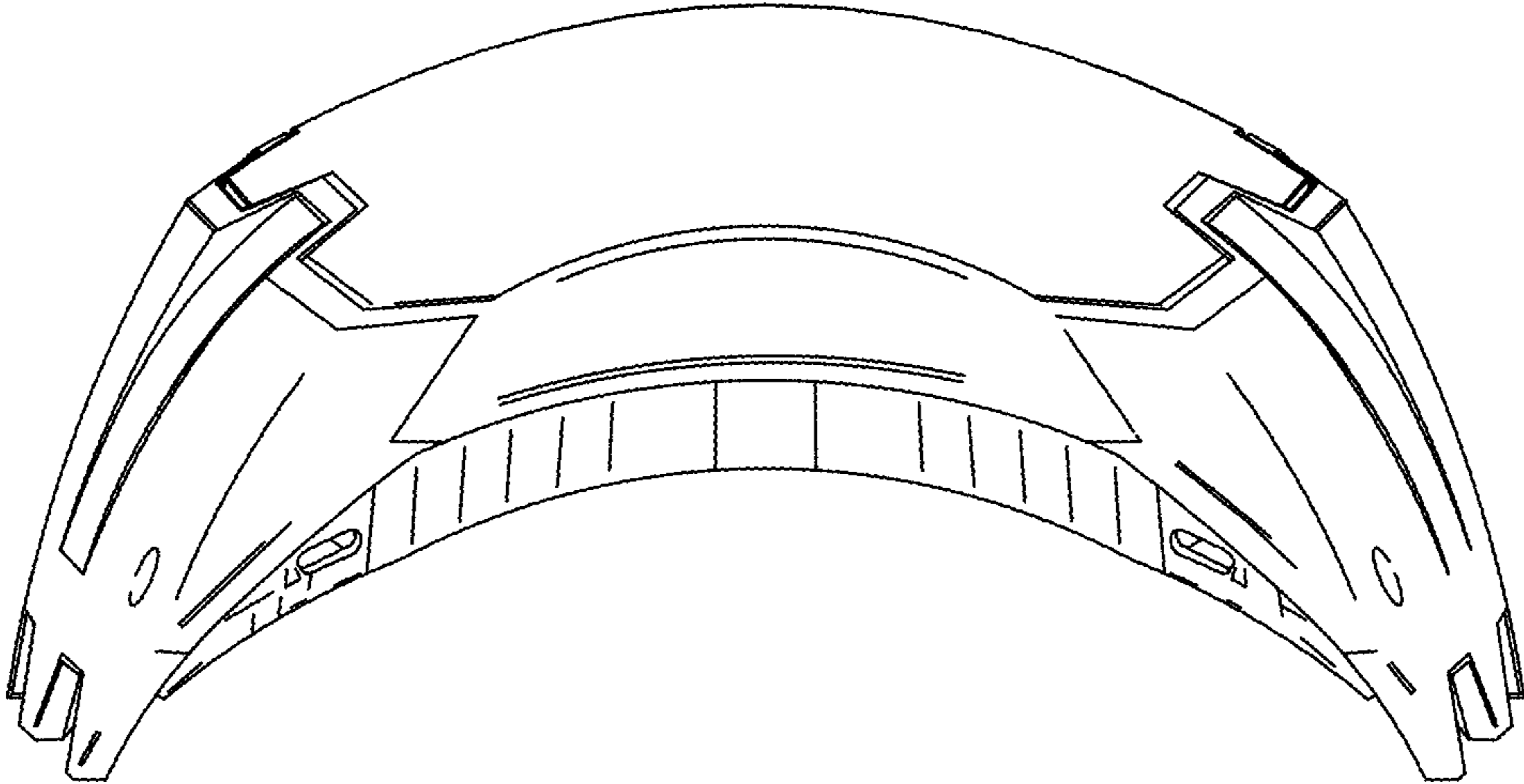

FIG. 7



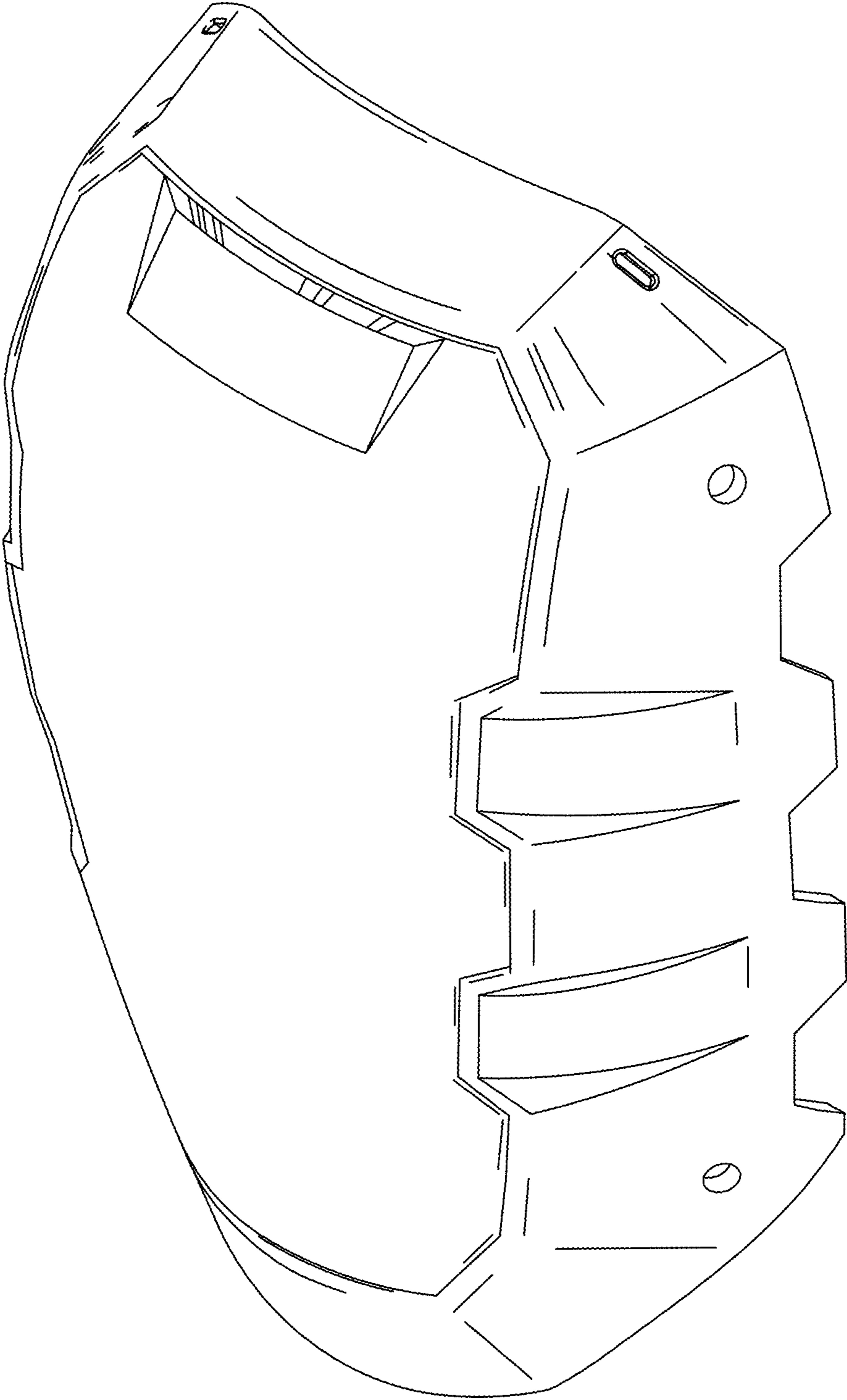

FIG. 8