



US00D832521S

(12) **United States Design Patent** (10) **Patent No.:** **US D832,521 S**  
**West** (45) **Date of Patent:** **\*\* Oct. 30, 2018**

- (54) **MASCARA CONTAINER WITH RETRACTABLE WAND**
- (71) Applicant: **SINGLEMASTER LLC**, New York, NY (US)
- (72) Inventor: **Margot West**, New York, NY (US)
- (73) Assignee: **Singlemaster LLC**, New York, NY (US)
- (\*\*) Term: **15 Years**
- (21) Appl. No.: **29/640,975**
- (22) Filed: **Mar. 19, 2018**
- (51) **LOC (11) Cl.** ..... **28-03**
- (52) **U.S. Cl.**  
USPC ..... **D28/76; D4/121; D4/128**
- (58) **Field of Classification Search**  
USPC ..... **D28/7, 76-77; D4/128, 116, 121, 114**  
(Continued)
- (56) **References Cited**

**U.S. PATENT DOCUMENTS**

D25,775 S \* 7/1896 Neubert ..... D4/121  
 783,937 A \* 2/1905 Edwards et al. .... A46B 9/06  
 15/172

(Continued)

*Primary Examiner* — Jennifer Rivard

(74) *Attorney, Agent, or Firm* — Knobbe, Martens, Olson & Bear, LLP

(57) **CLAIM**

The ornamental design for a mascara container with retractable wand, as shown and described.

**DESCRIPTION**

FIG. 1 is a front, top, and side perspective view of a first embodiment showing a mascara container with retractable wand embodying my new design, with a mascara brush of the retractable mascara wand fully extended.

FIG. 2 is a front view thereof.

FIG. 3 is a back view thereof.

FIG. 4 is a left side view thereof.

FIG. 5 is a right side view thereof.

FIG. 6 is a top view thereof.

FIG. 7 is a bottom view thereof.

FIG. 8 is a front, top, and side perspective view thereof, with the mascara brush extending about perpendicularly to a body of the mascara container with retractable wand.

FIG. 9 is a front view thereof.

FIG. 10 is a back view thereof.

FIG. 11 is a left side view thereof.

FIG. 12 is a right side view thereof.

FIG. 13 is a top view thereof.

FIG. 14 is a bottom view thereof.

FIG. 15 is a front, top, and side perspective view thereof, with the mascara brush facing downward within a channel of the body of the mascara container with retractable wand.

FIG. 16 is a front view thereof.

FIG. 17 is a back view thereof.

FIG. 18 is a left side view thereof.

FIG. 19 is a right side view thereof.

FIG. 20 is a top view thereof.

FIG. 21 is a bottom view thereof.

FIG. 22 is a front, top, and side perspective view thereof, with the mascara brush enclosed within a mascara reservoir of the body of the mascara container with retractable wand.

FIG. 23 is a front view thereof.

FIG. 24 is a back view thereof.

FIG. 25 is a left side view thereof.

FIG. 26 is a right side view thereof.

FIG. 27 is a top view thereof.

FIG. 28 is a bottom view thereof.

FIG. 29 is a front, top, and side perspective view thereof, with the mascara brush in a locked position within the mascara reservoir of the body of the mascara container with retractable wand.

FIG. 30 is a front view thereof.

FIG. 31 is a back view thereof.

FIG. 32 is a left side view thereof.

FIG. 33 is a right side view thereof.

FIG. 34 is a top view thereof; and,

FIG. 35 is a bottom view thereof.

Broken lines are used to illustrate features, which form no part of the claimed design.

**1 Claim, 30 Drawing Sheets**

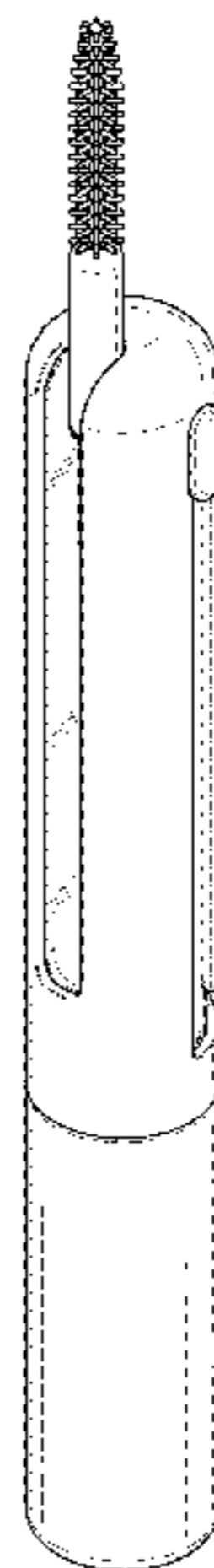

(58) **Field of Classification Search**

CPC ..... A46B 9/021; A46B 2200/1046; A46B  
2200/1053; A46B 11/0037; A45D 40/262;  
A45D 40/267

See application file for complete search history.

(56) **References Cited**

U.S. PATENT DOCUMENTS

1,588,633 A \* 6/1926 Taylor ..... A45D 27/04  
132/290  
4,165,755 A \* 8/1979 Cassai ..... A45D 40/265  
132/218  
D270,769 S \* 9/1983 Cassai ..... D28/7  
4,687,364 A \* 8/1987 Kingsford ..... A45D 40/264  
132/218  
5,951,185 A \* 9/1999 Kingsford ..... A45D 34/043  
132/218  
6,371,129 B1 \* 4/2002 Le Bras-Brown ... A45D 34/043  
132/218

D456,952 S \* 5/2002 Sakurai ..... A45D 34/043  
D28/76  
6,497,235 B2 \* 12/2002 Dorsa ..... A45D 34/06  
132/218  
D598,655 S \* 8/2009 Thorpe ..... D4/121  
8,292,529 B2 \* 10/2012 Francavilla ..... A45D 34/043  
401/101  
D703,955 S \* 5/2014 Nanda ..... A45D 40/265  
D4/104  
8,998,520 B1 \* 4/2015 Tanner ..... A45D 40/264  
401/109  
2004/0184865 A1 \* 9/2004 Carroll ..... A45D 40/20  
401/107  
2009/0097899 A1 \* 4/2009 Carroll ..... A45D 40/02  
401/109  
2010/0065080 A1 \* 3/2010 Wynne ..... A45D 40/262  
132/218  
2010/0139686 A1 \* 6/2010 Legassie ..... A45D 40/264  
132/218  
2011/0116857 A1 \* 5/2011 Carroll ..... A45D 34/04  
401/101

\* cited by examiner

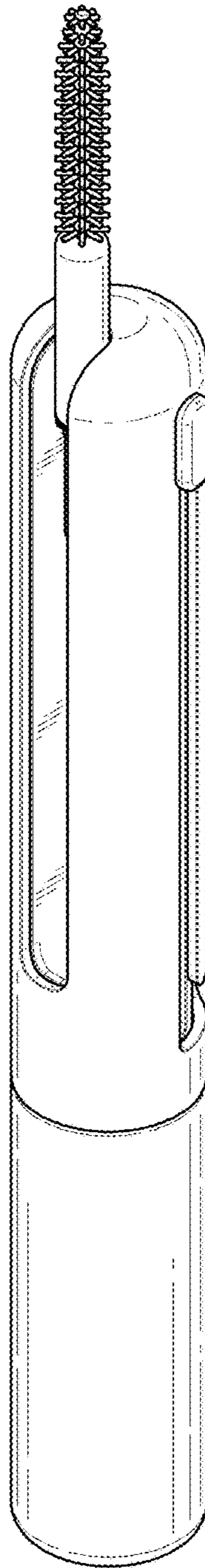

FIG. 1

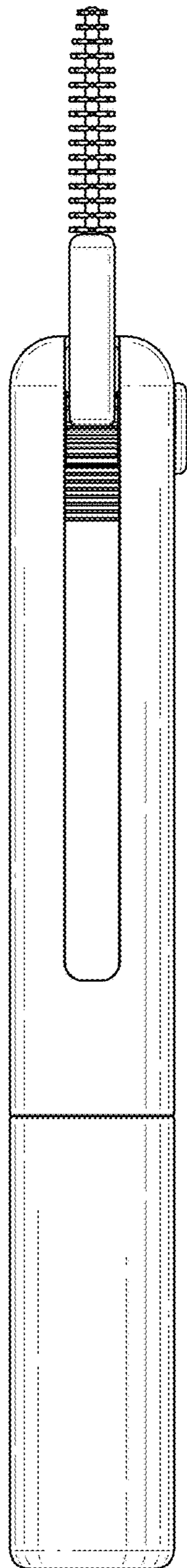

FIG. 2

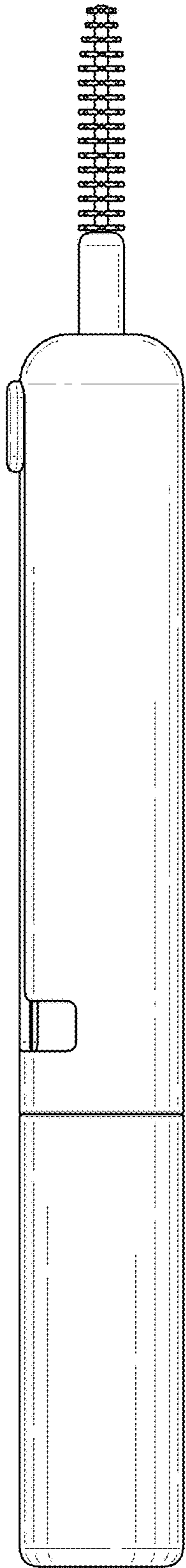

FIG. 3

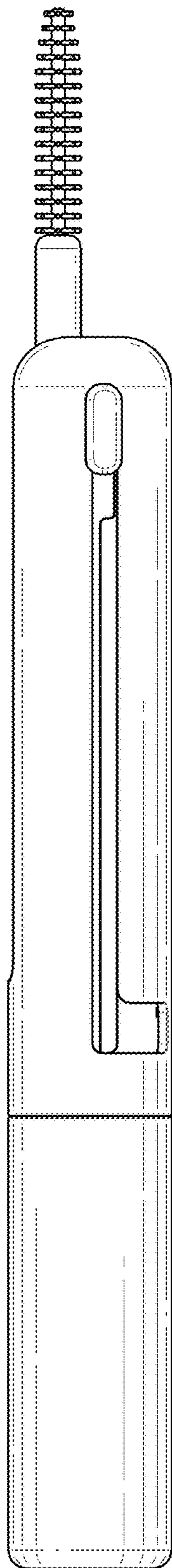

FIG. 4

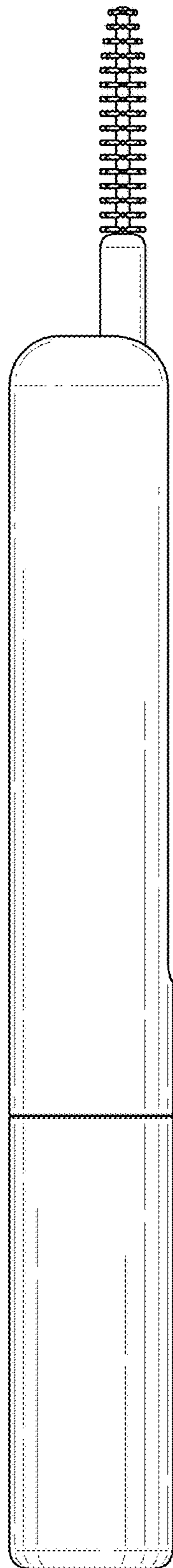

FIG. 5

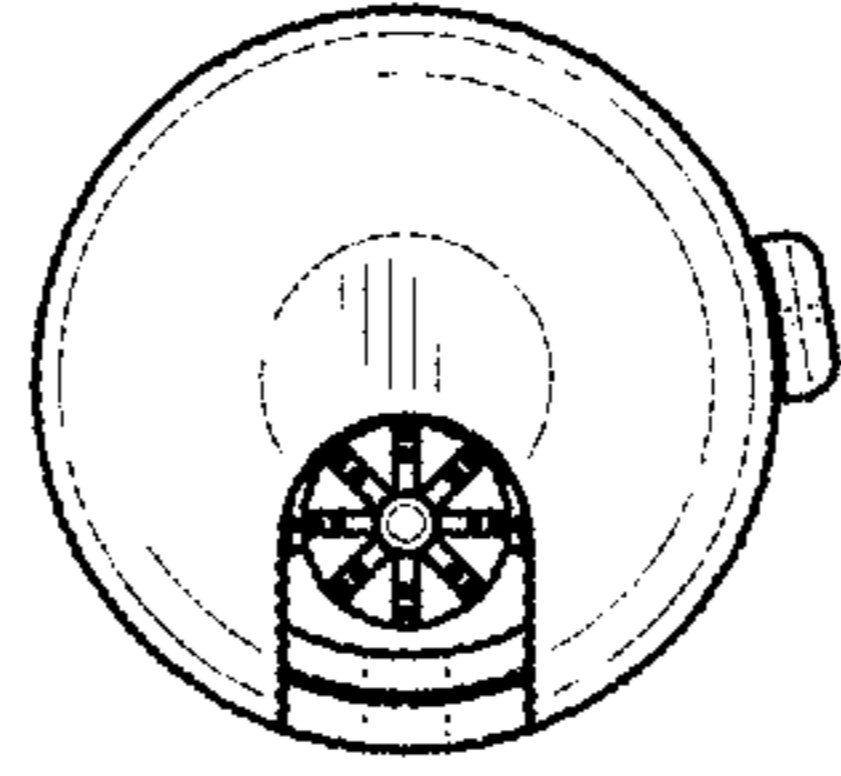

FIG. 6

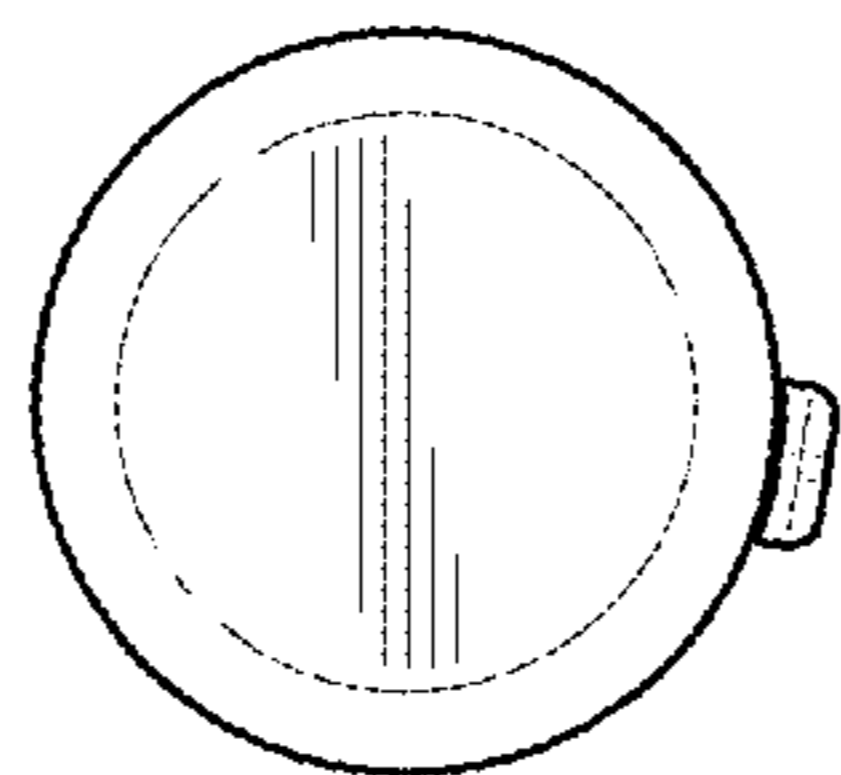

FIG. 7



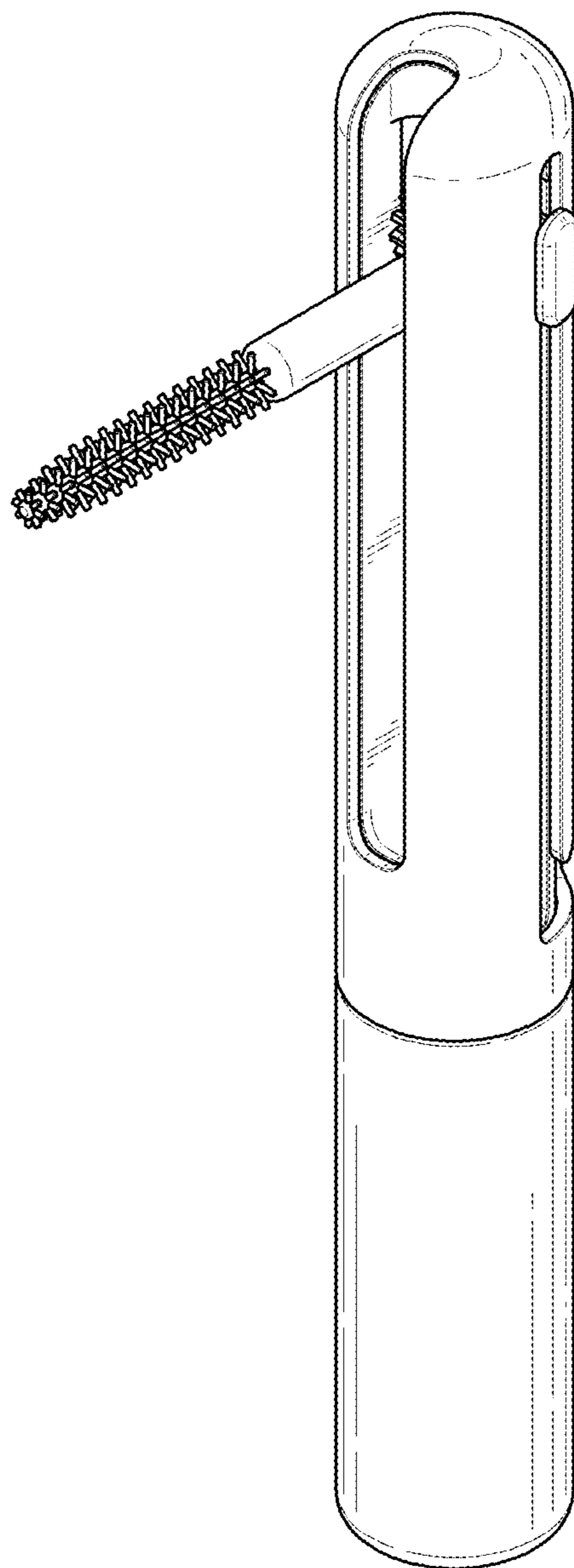

FIG. 8

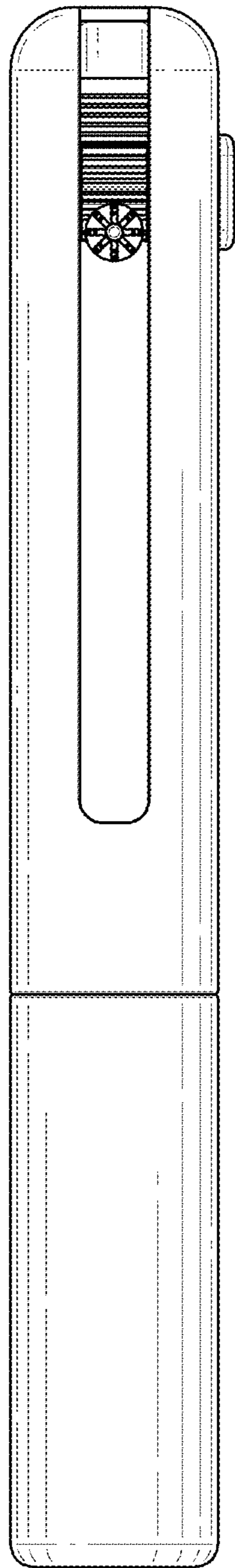

FIG. 9

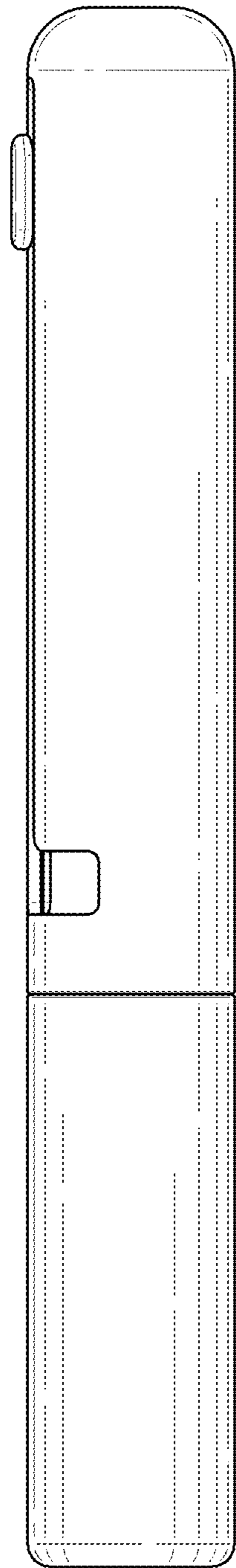

FIG. 10

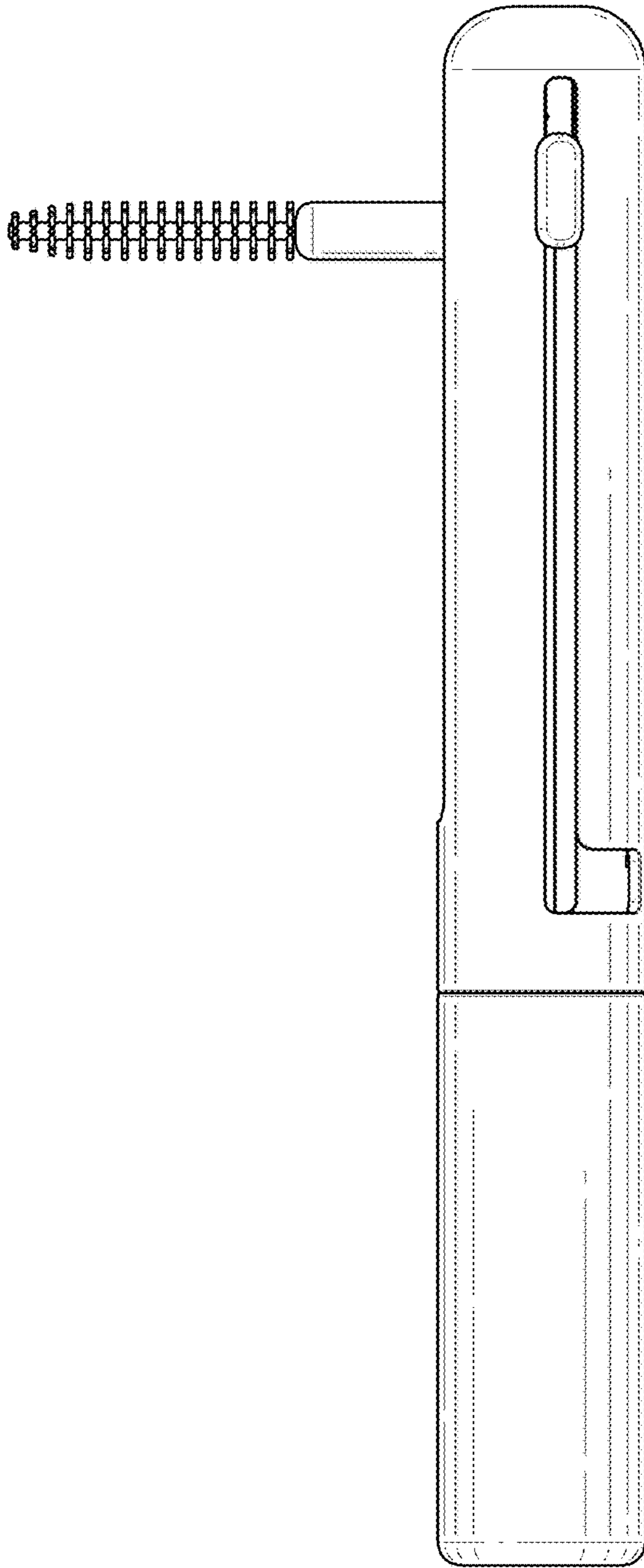

FIG. 11

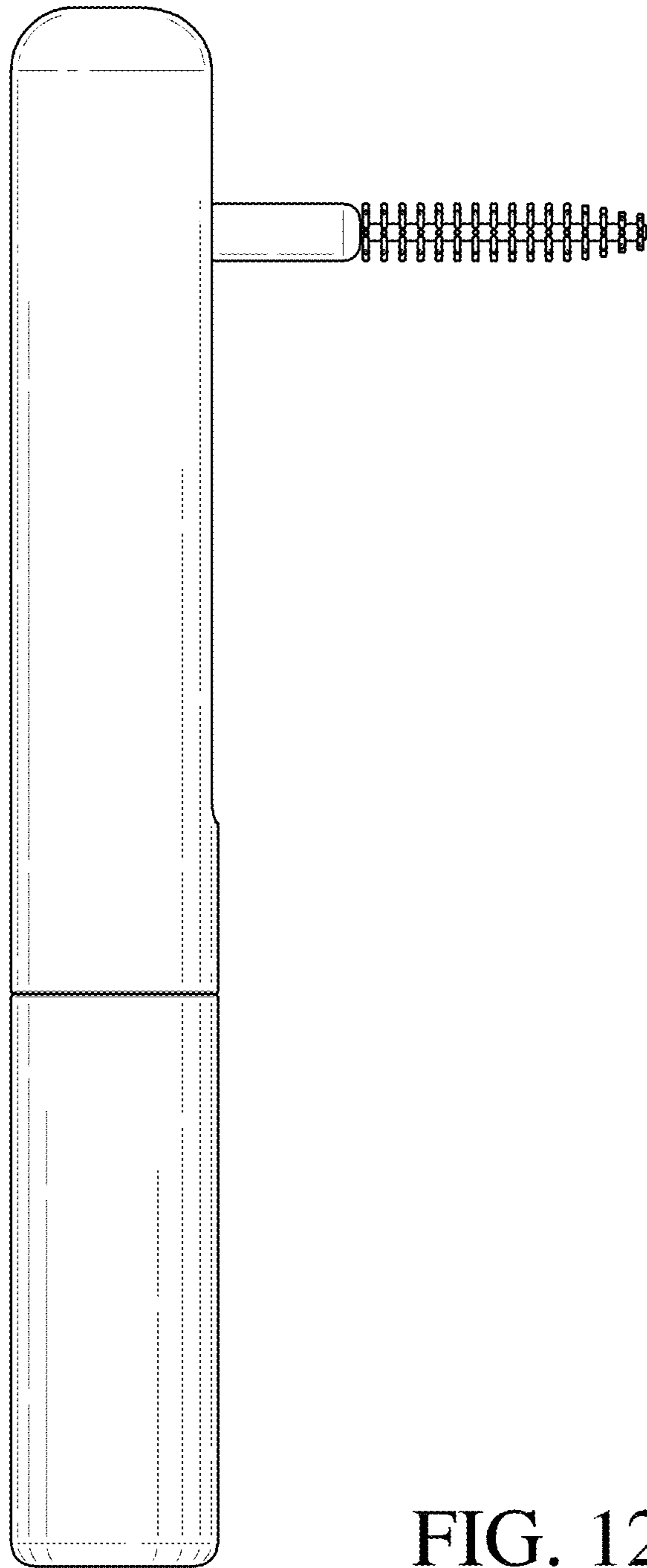

FIG. 12

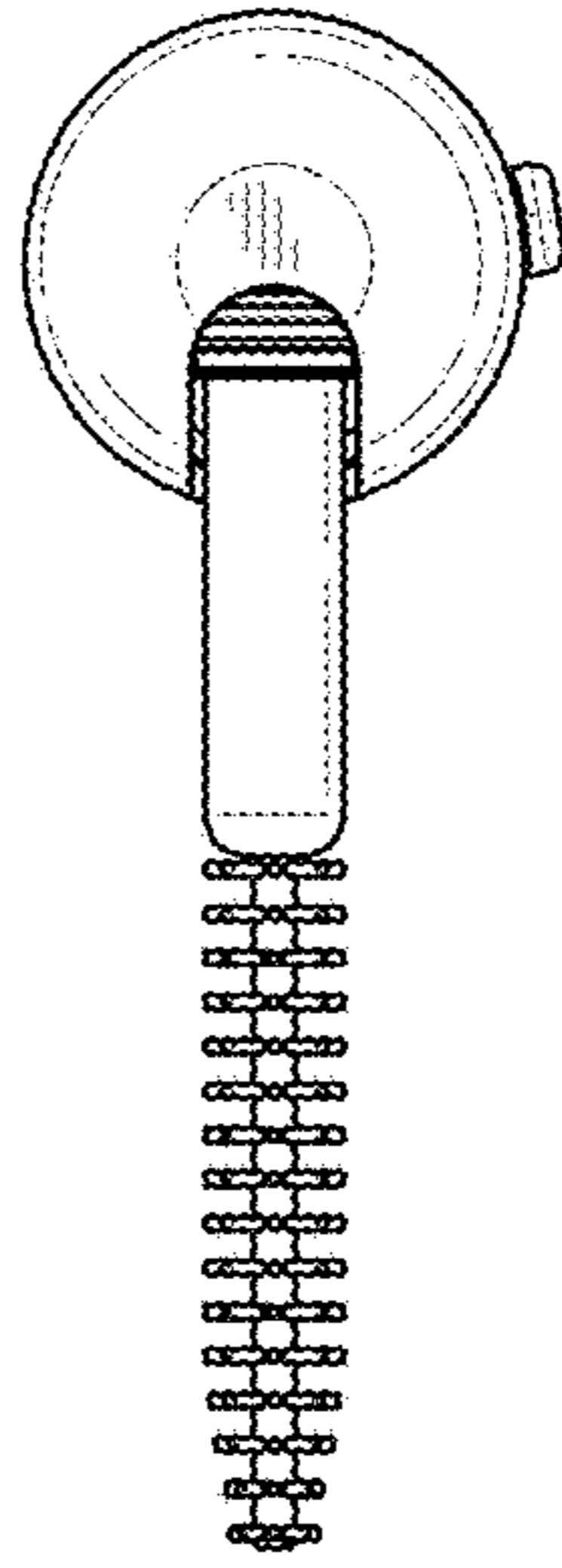

FIG. 13

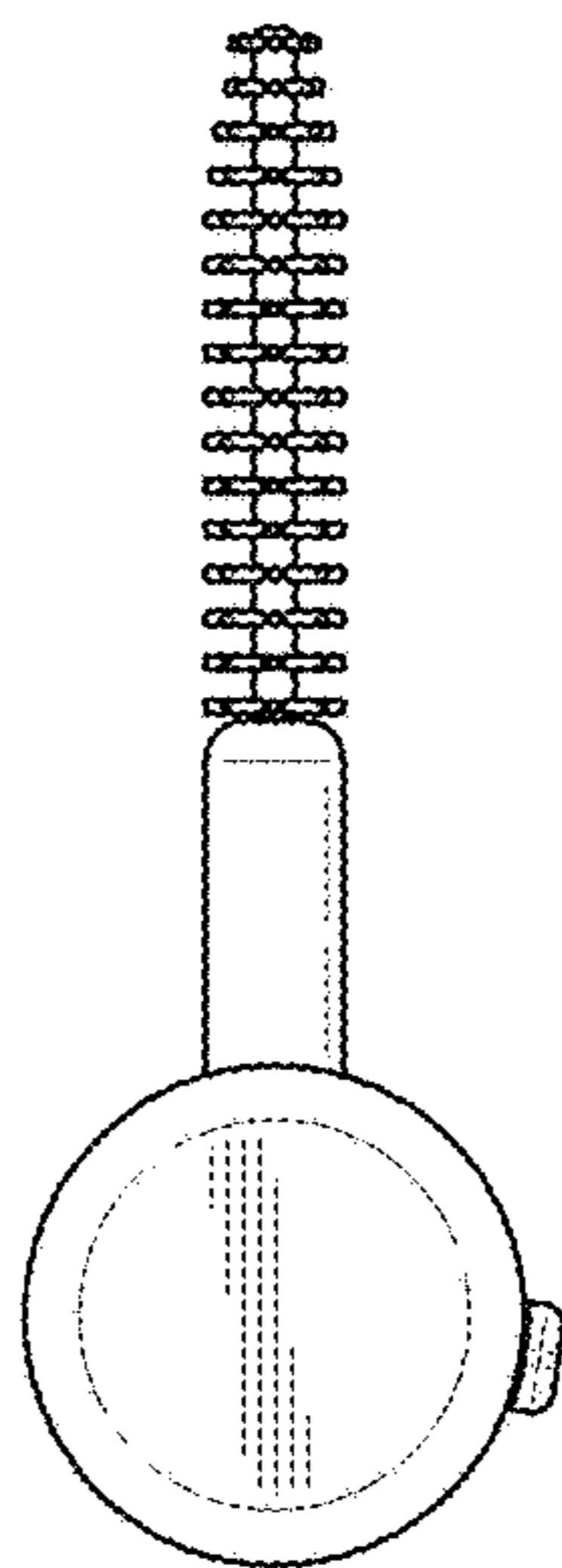

FIG. 14

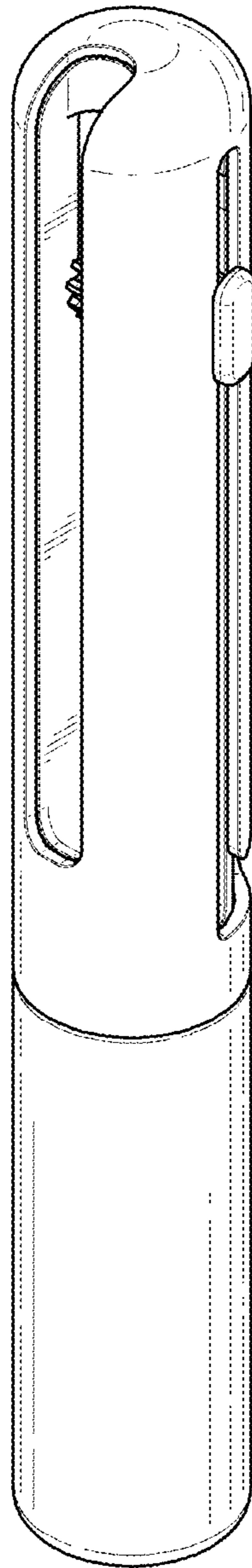

FIG. 15

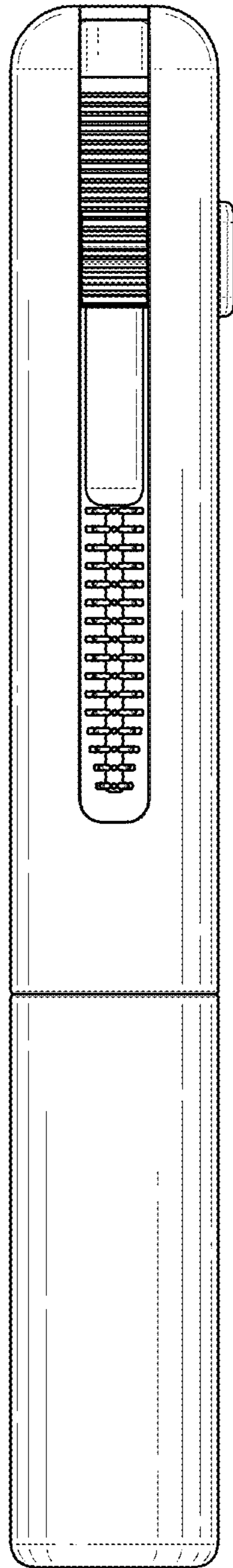

FIG. 16



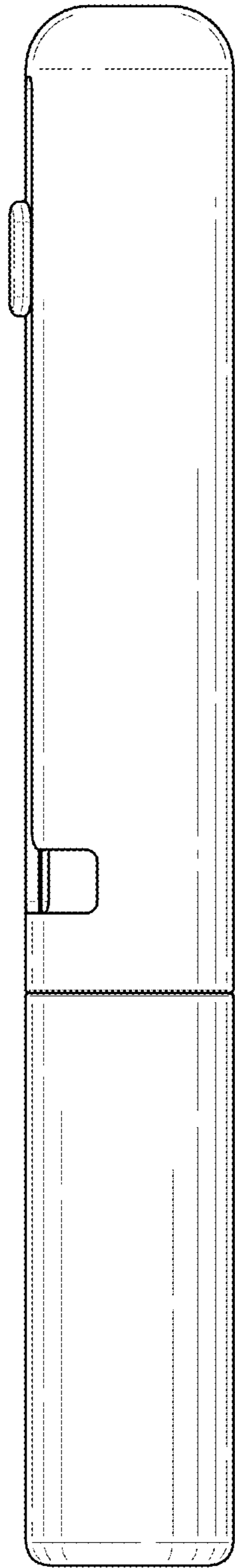

FIG. 17

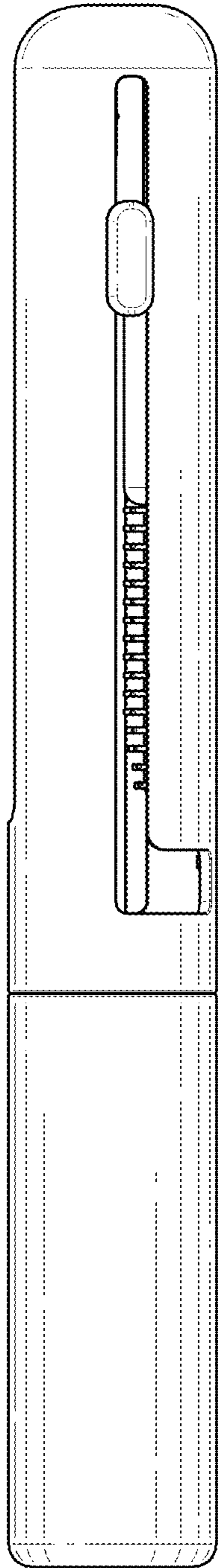

FIG. 18

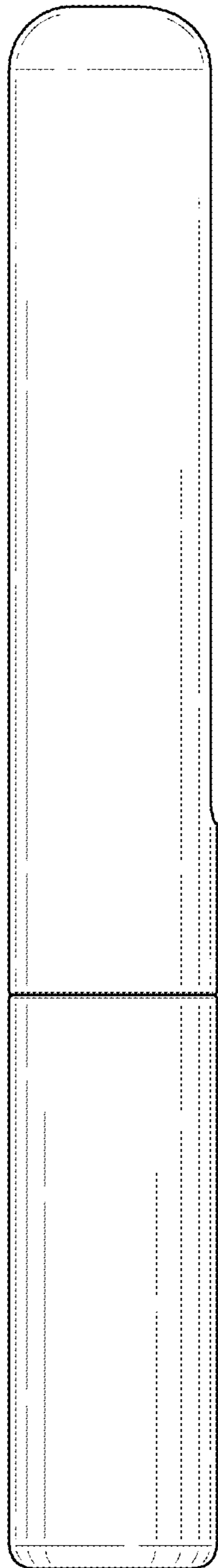

FIG. 19

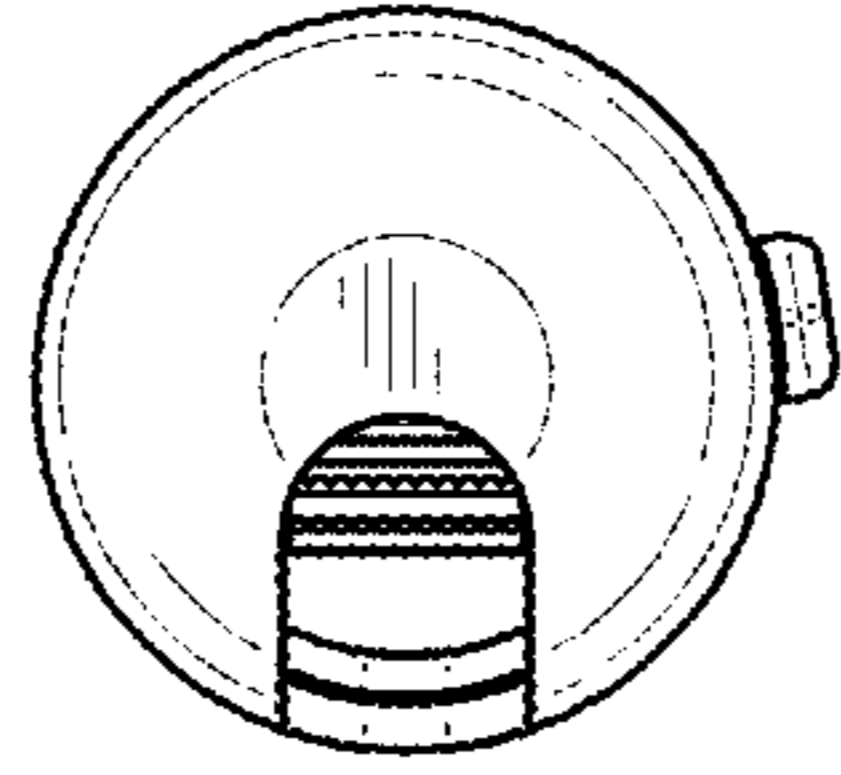

FIG. 20

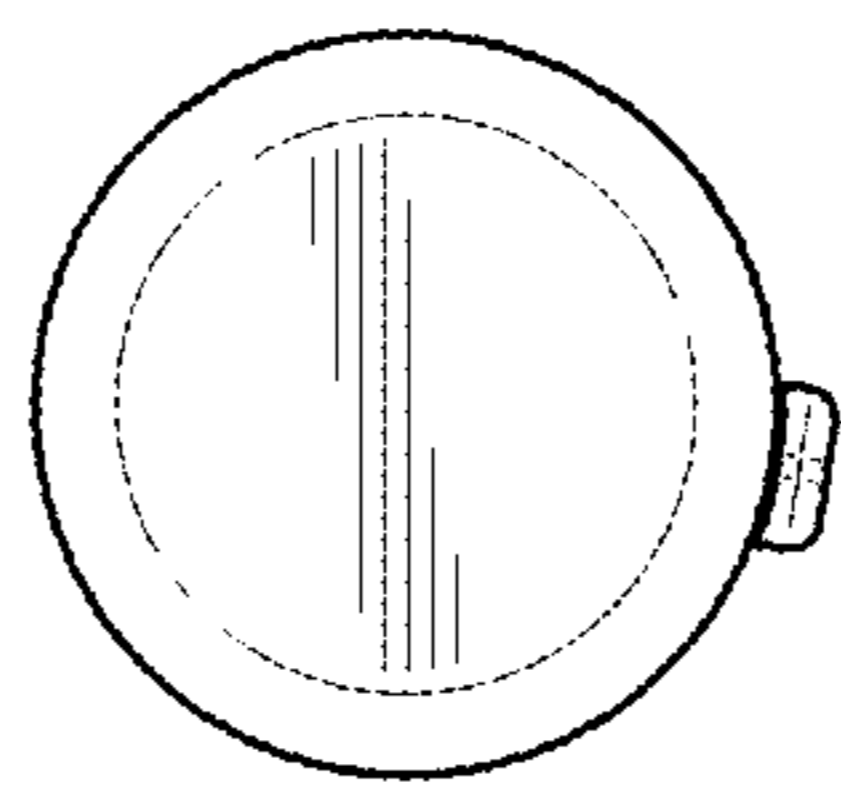

FIG. 21

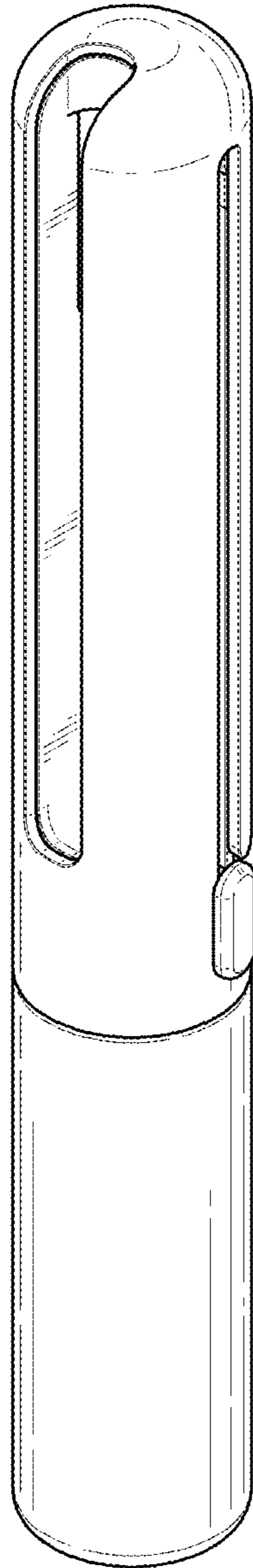

FIG. 22

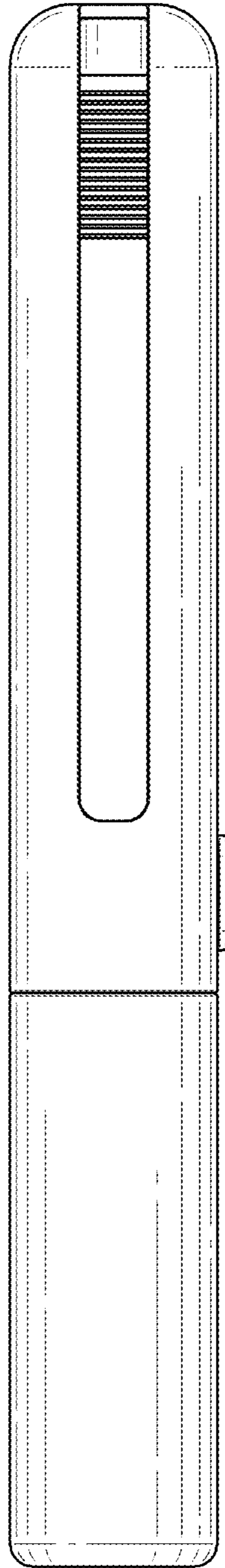

FIG. 23

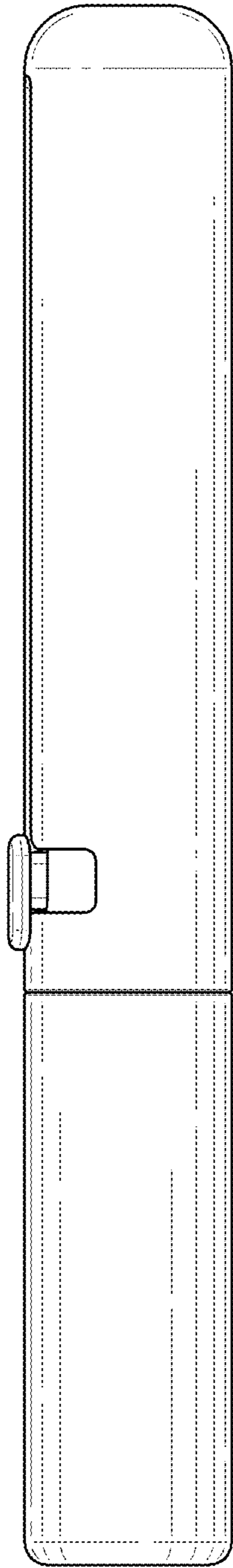

FIG. 24

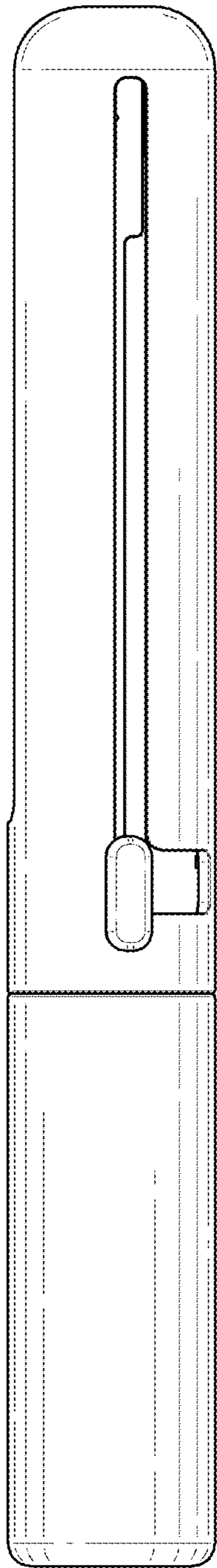

FIG. 25



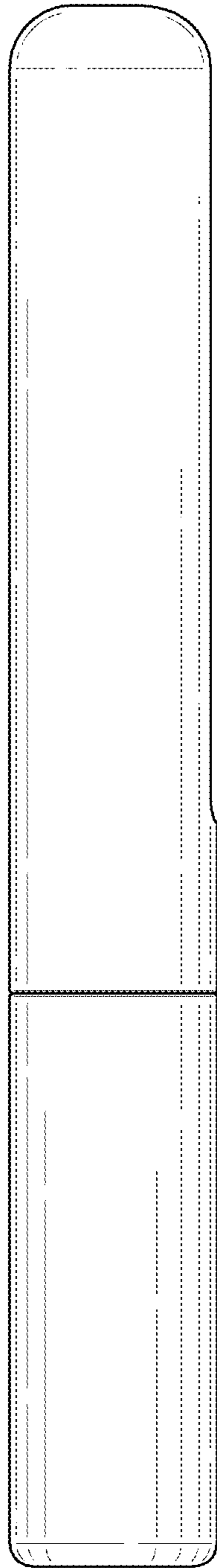

FIG. 26

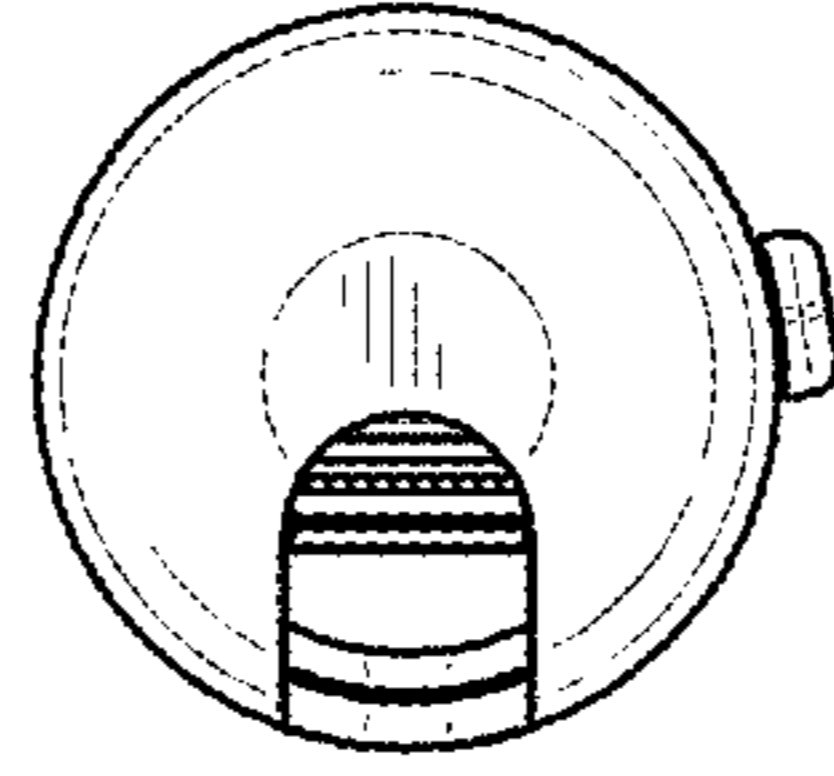

FIG. 27

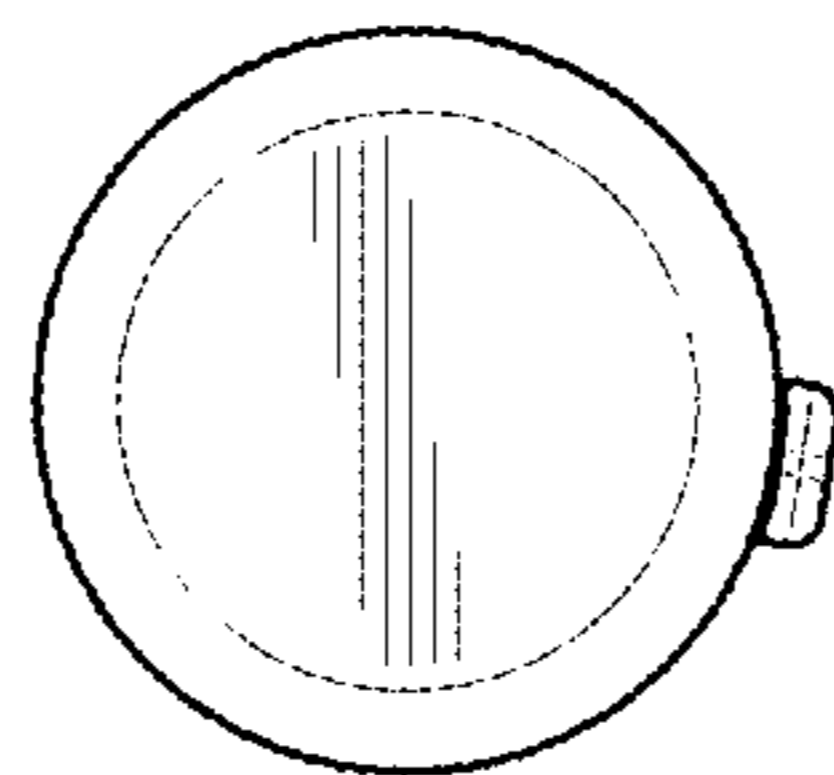

FIG. 28

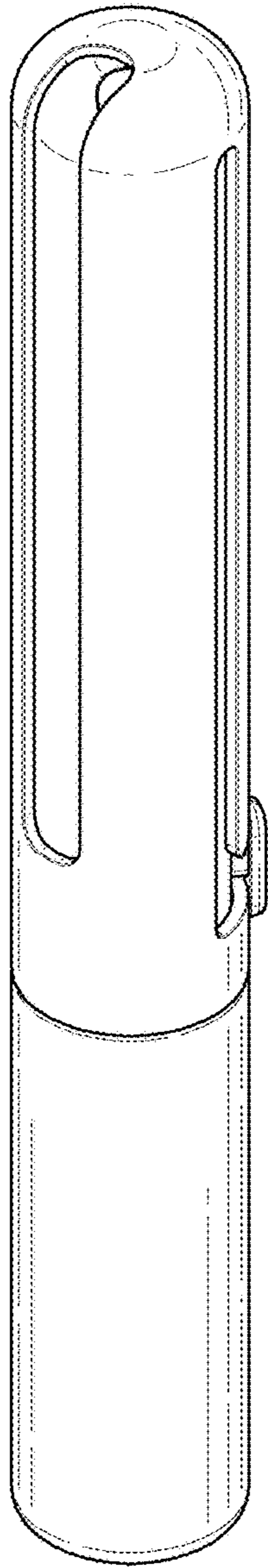

FIG. 29

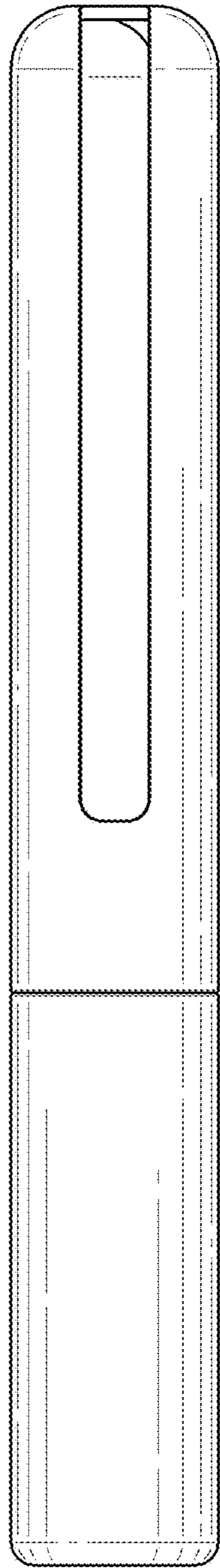

FIG. 30

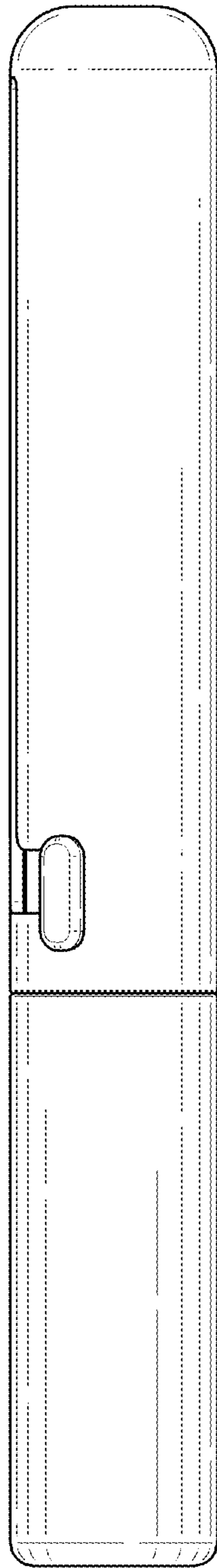

FIG. 31

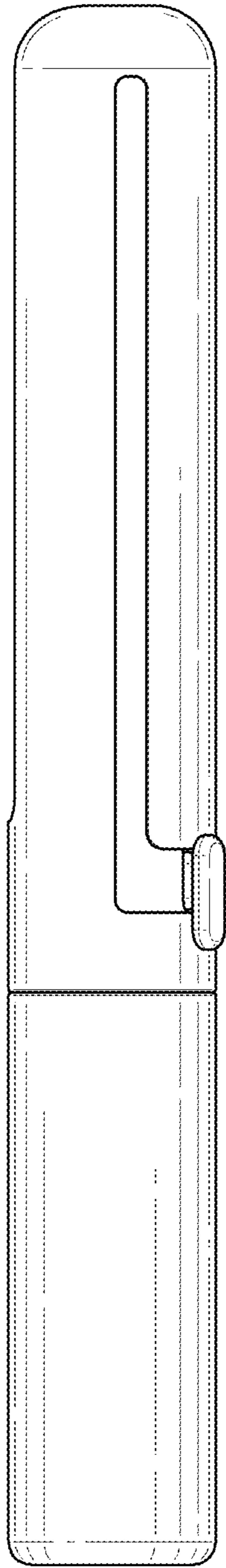

FIG. 32

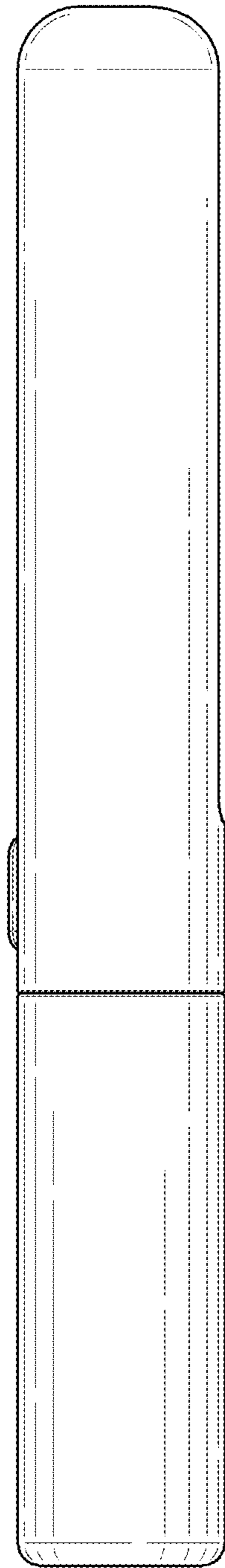

FIG. 33

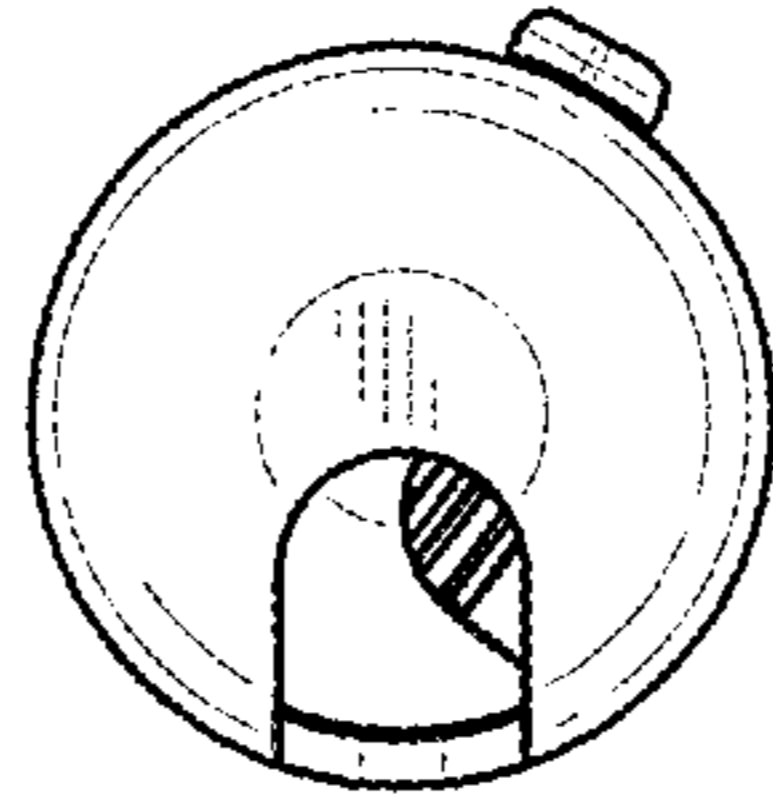

FIG. 34

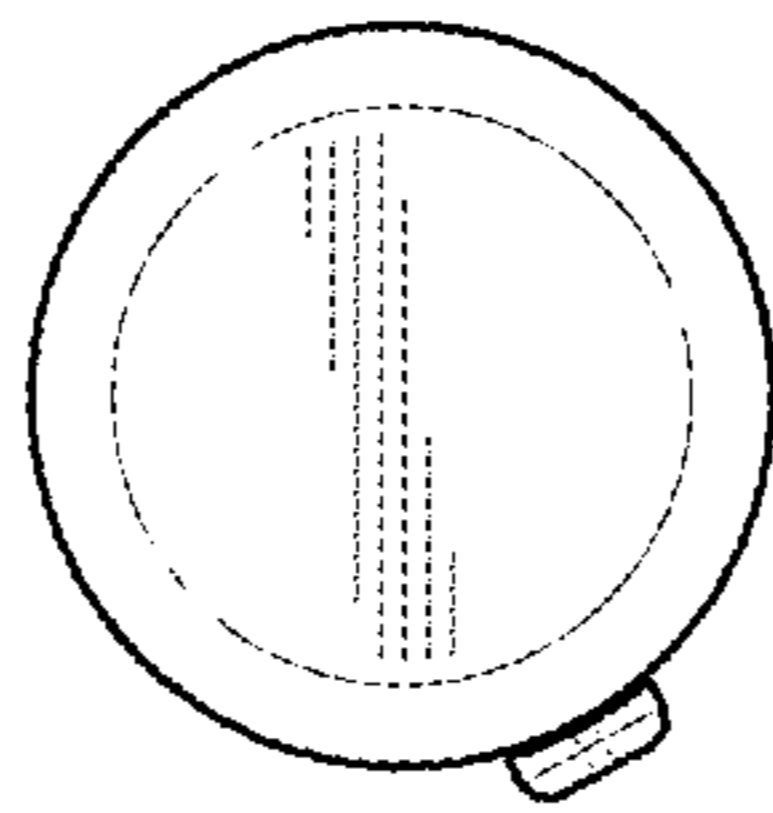

FIG. 35