



US00D832510S

(12) **United States Design Patent**
Kuzia et al.

(10) **Patent No.:** **US D832,510 S**
(45) **Date of Patent:** **** Oct. 30, 2018**

- (54) **HAIR DRYER**
- (71) Applicant: **Spectrum Brands, Inc.**, Middleton, WI (US)
- (72) Inventors: **Jay William Kuzia**, Madison, WI (US);
Seung Il Kim, Madison, WI (US);
Michael John deGrood, Madison, WI (US)
- (73) Assignee: **Spectrum Brands, Inc.**, Middleton, WI (US)
- (**) Term: **15 Years**
- (21) Appl. No.: **29/613,627**
- (22) Filed: **Aug. 11, 2017**
- (51) **LOC (11) Cl.** **28-03**
- (52) **U.S. Cl.**
USPC **D28/18**
- (58) **Field of Classification Search**
USPC D28/10, 11, 12, 13, 14, 15, 16, 17, 18,
D28/19
CPC A45D 20/00; A45D 20/04; A45D 20/06;
A45D 20/10; A45D 20/12; A45D 20/122;
A45D 20/124; A45D 20/18; A45D 20/48;
A45D 20/52
See application file for complete search history.

(56) **References Cited**

U.S. PATENT DOCUMENTS

- D265,767 S * 8/1982 Stewart D28/13
- D278,085 S 3/1985 Rittenhouse et al.
- 4,910,385 A * 3/1990 Shye-Long A45D 20/12
200/332.2
- 5,013,891 A * 5/1991 Shoemaker A45D 20/12
219/383
- 5,715,847 A * 2/1998 Rolf A45D 20/122
132/129
- D398,073 S * 9/1998 Kip D28/13
- D425,665 S * 5/2000 Kling D28/13

- D456,943 S 5/2002 Micinilio et al.
- D473,341 S 4/2003 Bokelman-Dumas
- D651,341 S 12/2011 Schmitz
- D655,037 S * 2/2012 Mau D28/13
- D677,834 S 3/2013 Sayers et al.
- D716,999 S 11/2014 Americano
- D791,407 S * 7/2017 Smith D28/13
- 2002/0043003 A1 * 4/2002 Cruz A45D 20/12
34/97

(Continued)

OTHER PUBLICATIONS

Remington UK Air 3D Hair Dryer, posted Jan. 5, 2018 [online],
retrieved May 22, 2018, retrieved from internet, <<https://www.youtube.com/watch?v=umZZpWMhIKo>>.*

(Continued)

Primary Examiner — Barbara Fox

Assistant Examiner — Messina L Smith

(74) *Attorney, Agent, or Firm* — Banner & Witcoff, Ltd.

(57) **CLAIM**

The ornamental design for a hair dryer, as shown and described.

DESCRIPTION

FIG. 1 is a front perspective view of a hair dryer showing our new design;
 FIG. 2 is a rear perspective view thereof;
 FIG. 3 is a front view thereof;
 FIG. 4 is a rear view thereof;
 FIG. 5 is a right side view thereof;
 FIG. 6 is a left side view thereof;
 FIG. 7 is a top view thereof; and,
 FIG. 8 is a bottom view thereof.

In the drawings, the uneven-length broken lines illustrate the bounds of the claim; the even-length broken lines depict portions of the hair dryer. The broken lines form no part of the claimed design.

1 Claim, 8 Drawing Sheets

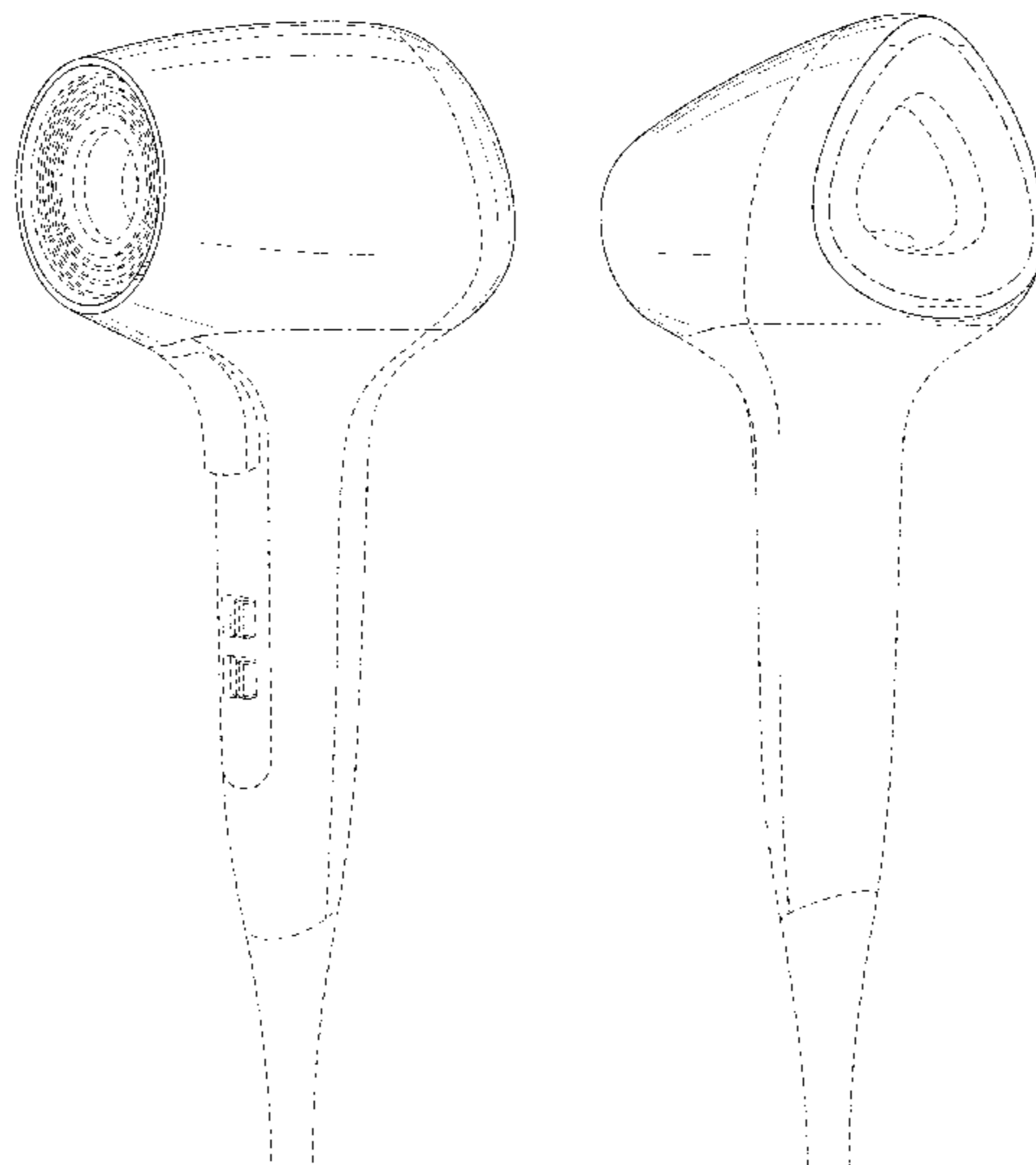

(56)

References Cited

U.S. PATENT DOCUMENTS

2005/0091864 A1* 5/2005 Sullivan A45D 20/12
34/90
2007/0220774 A1* 9/2007 Shin A45D 20/12
34/96
2008/0301968 A1* 12/2008 Lee A45D 20/12
34/97
2017/0164711 A1* 6/2017 Childe A45D 20/12
2017/0258196 A1* 9/2017 Miyata A45D 1/04
2018/0049532 A1* 2/2018 Hsu F26B 23/06

OTHER PUBLICATIONS

Remington Air 3D Hair Dryer Review, posted Nov. 14, 2017 [online], retrieved May 22, 2018, retrieved from internet, <<https://lunavioleta.co.uk/air-3d-hair-dryer-review/>>.*

Conair; “Infinitipro by Conair 1875-Watt Salon Performance AC Motor Styling Tool”; Publication date unknown but prior to filing date of present application; Date Accessed: Aug. 2, 2017; URL: <<https://www.conair.com/c/1e2f14/1875watt-salon-performance-ac-motor-styling-tool/92>>.

Walmart; “Remington Ultimate Finish Hair Dryer”; Publication date unknown but prior to filing date of present application; Date Accessed: Aug. 4, 2017; URL: <<https://www.walmart.com/ip/Remington-Ultimate-Finish-Hair-Dryer/46175588>>.

Souq; “Remington Compact Hair Dryer—D5000 Black”; Publication date unknown but prior to filing date of present application; Date Accessed: Aug. 4, 2017; URL: <<https://uae.souq.com/ae-en/remington-compact-hair-dryer-d5000-black-8667371/i/>>.

* cited by examiner

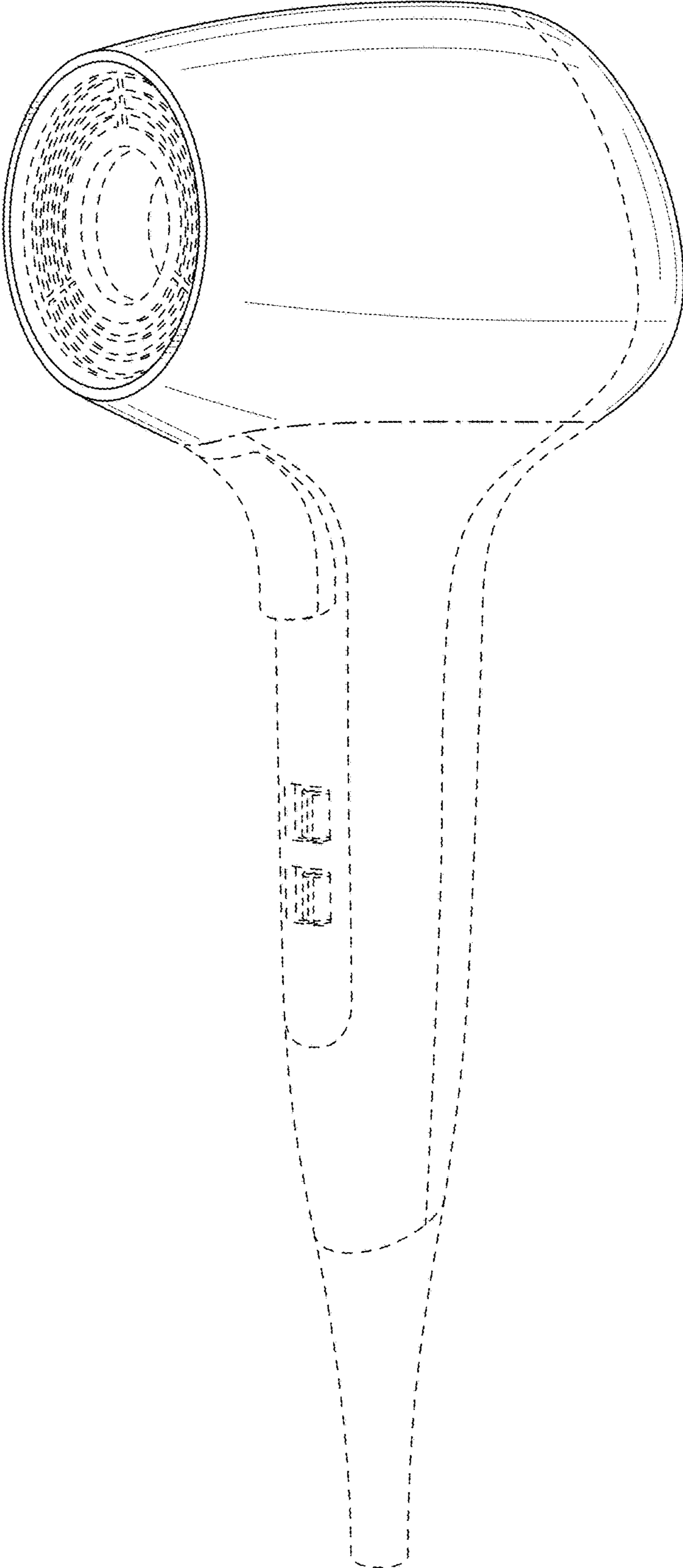

FIG. 1

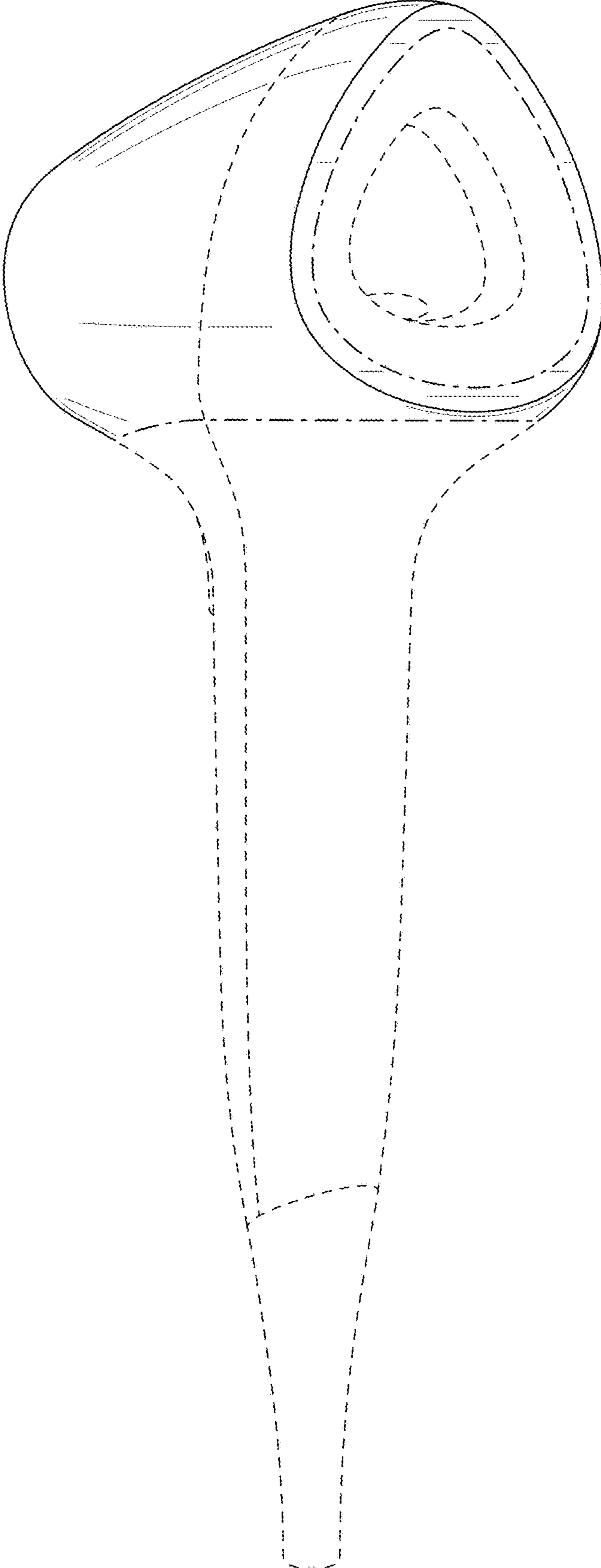

FIG. 2

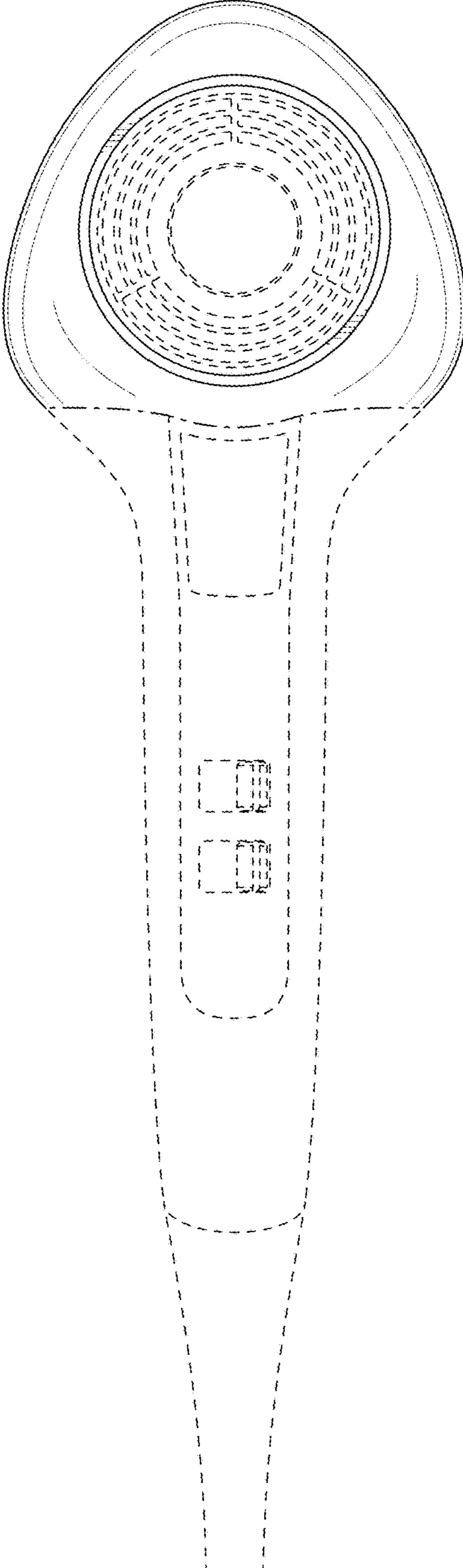

FIG. 3

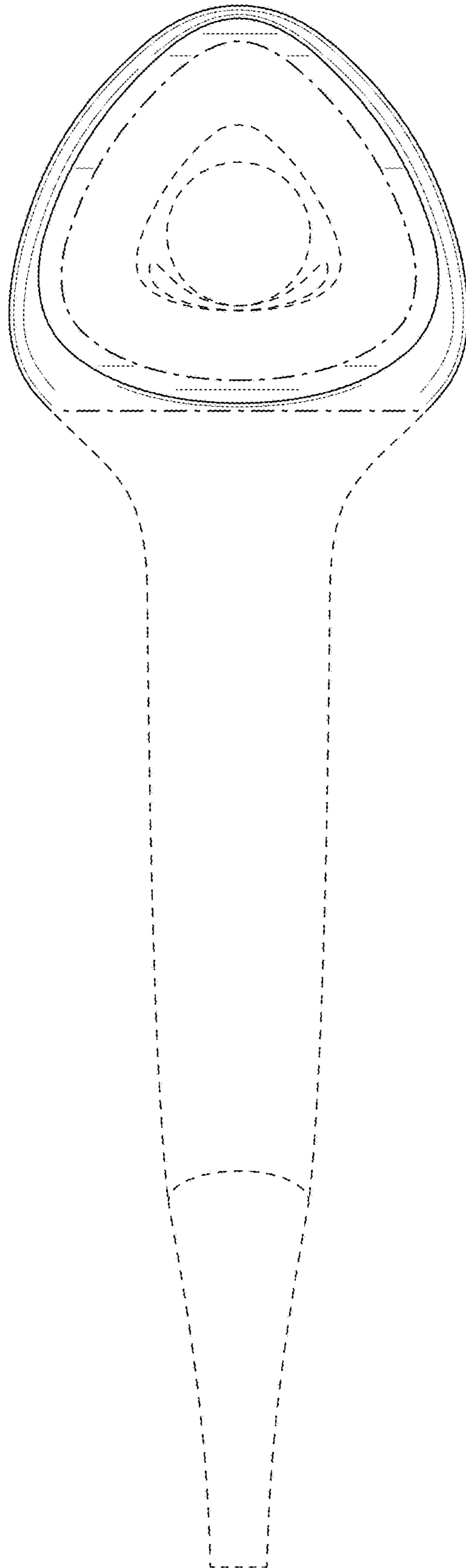

FIG. 4

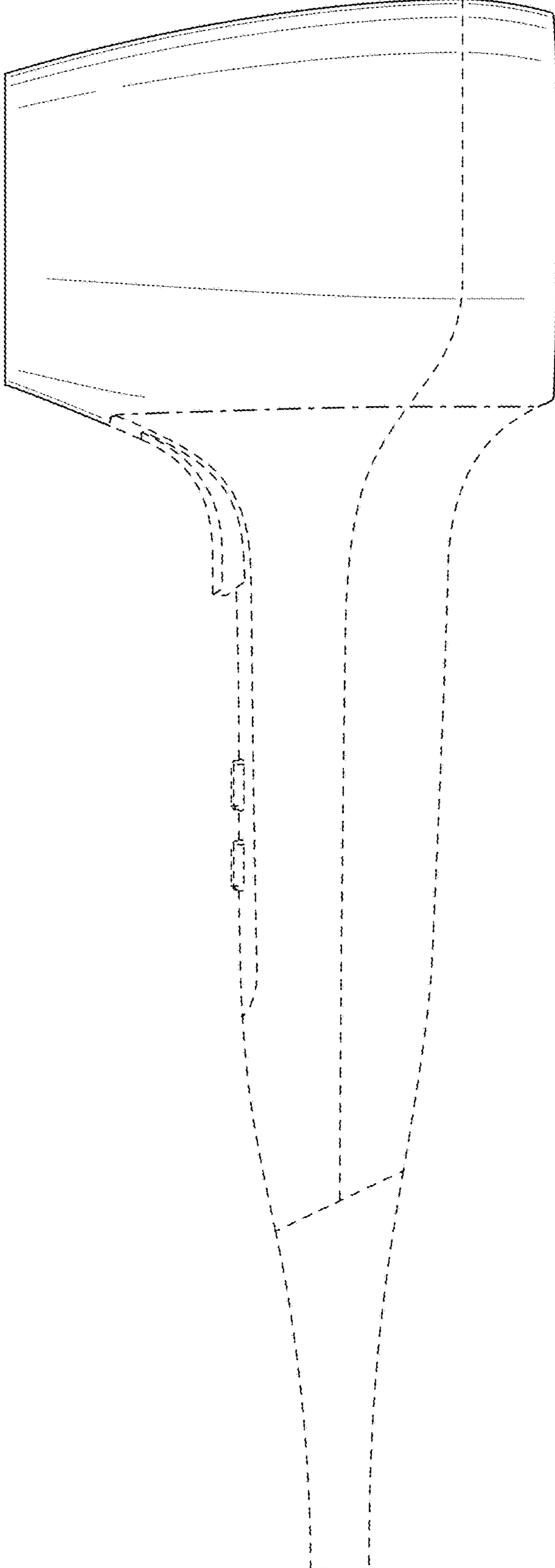

FIG. 5

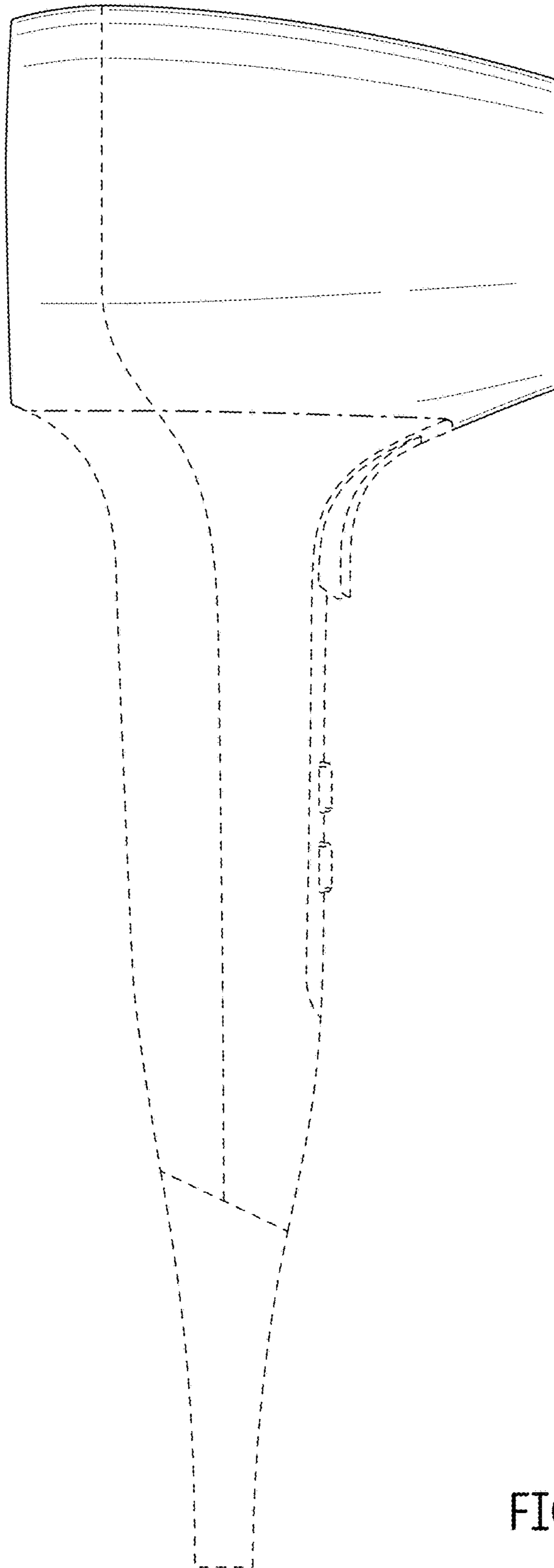

FIG. 6

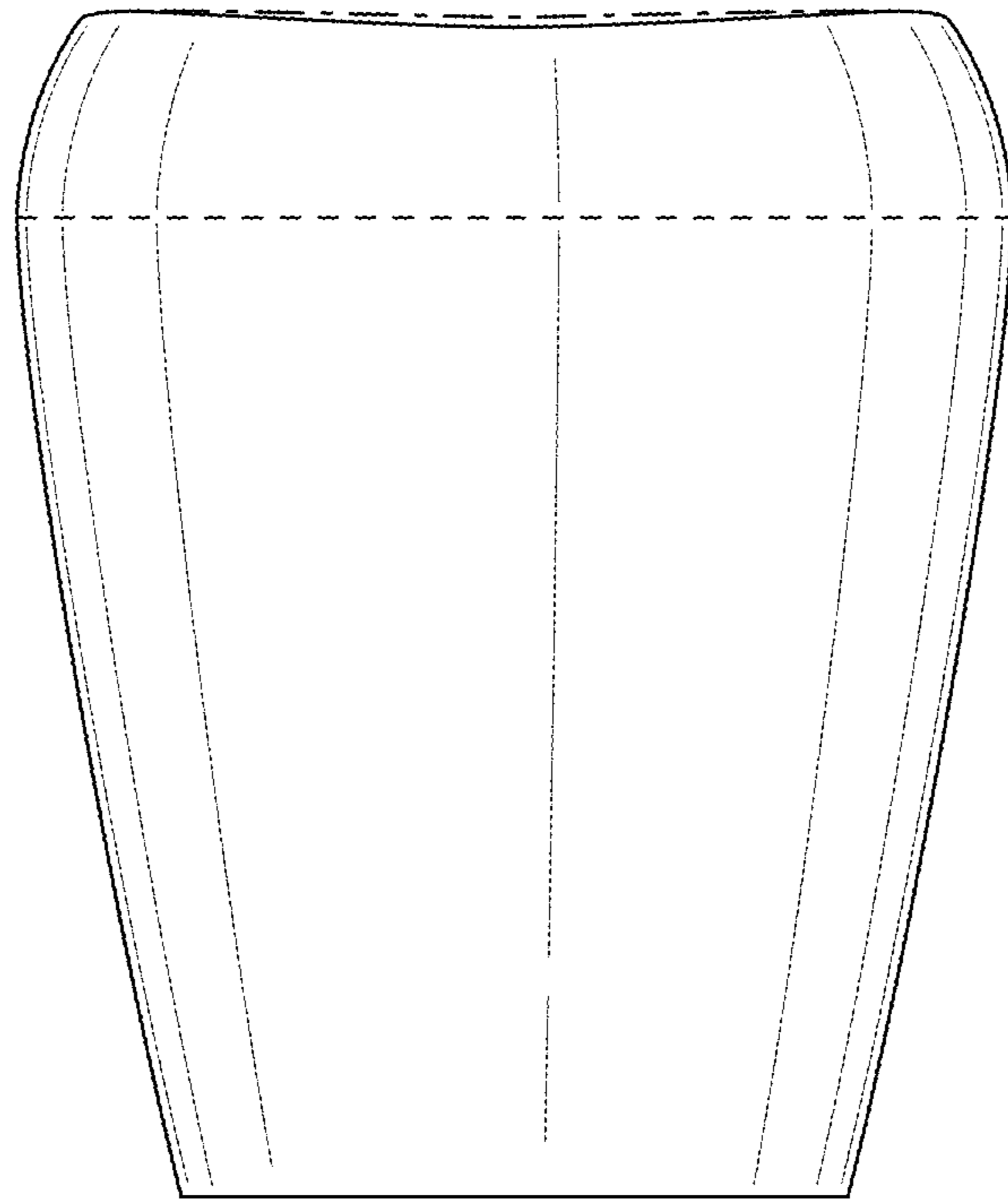

FIG. 7

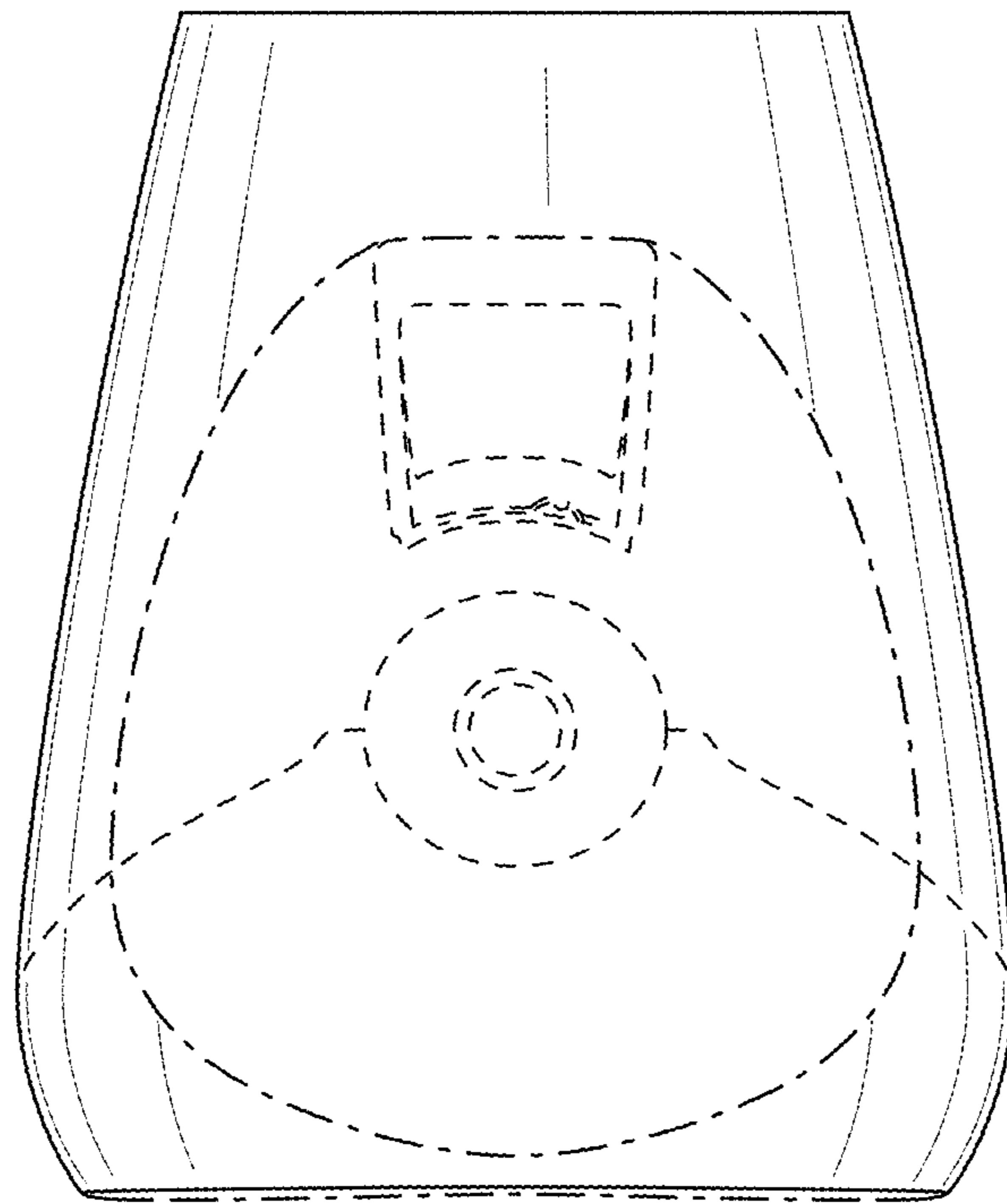

FIG. 8