



US00D832441S

(12) **United States Design Patent** (10) **Patent No.:** **US D832,441 S**
Dacosta et al. (45) **Date of Patent:** **** Oct. 30, 2018**

(54) **SPACER WEDGE** 7,018,416 B2 * 3/2006 Hanson A61B 17/1671
623/17.16

(71) Applicant: **PARAGON 28, INC.**, Englewood, CO 8,357,167 B2 1/2013 Errico et al.
(US) D691,272 S 10/2013 DaCosta et al.
D720,456 S 12/2014 DaCosta et al.
D720,457 S 12/2014 Bono et al.
(72) Inventors: **Albert Dacosta**, Lone Tree, CO (US); D767,133 S 9/2016 Gotfried
Benjamin Majors, Englewood, CO 9,585,765 B2 3/2017 Niemiec et al.
(US) D794,796 S 8/2017 Lin
2003/0105526 A1 6/2003 Bryant et al.
(73) Assignee: **PARAGON 28, INC.**, Englewood, CO 2006/0085071 A1 * 4/2006 Lechmann A61B 17/86
(US) 623/17.11
2008/0269758 A1 * 10/2008 Baynham A61F 2/4455
606/90

(**) Term: **15 Years** (Continued)

(21) Appl. No.: **29/639,277**
(22) Filed: **Mar. 5, 2018**

Primary Examiner — Charles D Hanson
(74) *Attorney, Agent, or Firm* — Heslin Rothenberg
Farley & Mesiti P.C.

Related U.S. Application Data

(63) Continuation of application No. 29/591,158, filed on
Jan. 17, 2017, now Pat. No. Des. 814,037.

(51) **LOC (11) Cl.** **24-02**

(52) **U.S. Cl.**
USPC **D24/155**

(58) **Field of Classification Search**
USPC D24/155–157
CPC A61F 2/4611; A61F 2/442; A61F 2/447;
A61F 2220/0025; A61F 2310/00023;
A61F 2310/00017; A61F 2002/4475;
A61F 2002/30841; A61F 2002/2835;
A61F 2002/30904; A61F 2002/30785;
A61F 2002/443; A61F 2002/30578
See application file for complete search history.

(56) **References Cited**

U.S. PATENT DOCUMENTS

4,863,477 A 9/1989 Monson
6,008,433 A 12/1999 Stone
6,723,097 B2 4/2004 Fraser et al.

(57) **CLAIM**

The ornamental design for a spacer wedge, as shown and
described.

DESCRIPTION

FIG. 1 is a left perspective view of the spacer wedge
comprising the new design;
FIG. 2 is a back perspective view of the design of FIG. 1;
FIG. 3 is a front elevational view of the design of FIG. 1,
wherein the back elevational view is a mirror image thereof;
FIG. 4 is a left elevational view of the design of FIG. 1;
FIG. 5 is a right side elevational view of the design of FIG.
1;
FIG. 6 is a top view of the design of FIG. 1; and,
FIG. 7 is a bottom view of the design of FIG. 1.
The broken lines shown in the figures are directed to the
environment and are for illustrative purposes only and form
no part of the claimed spacer wedge invention.
The relatively light uneven broken lines shown in the figures
represent contour, not surface decoration.

1 Claim, 3 Drawing Sheets

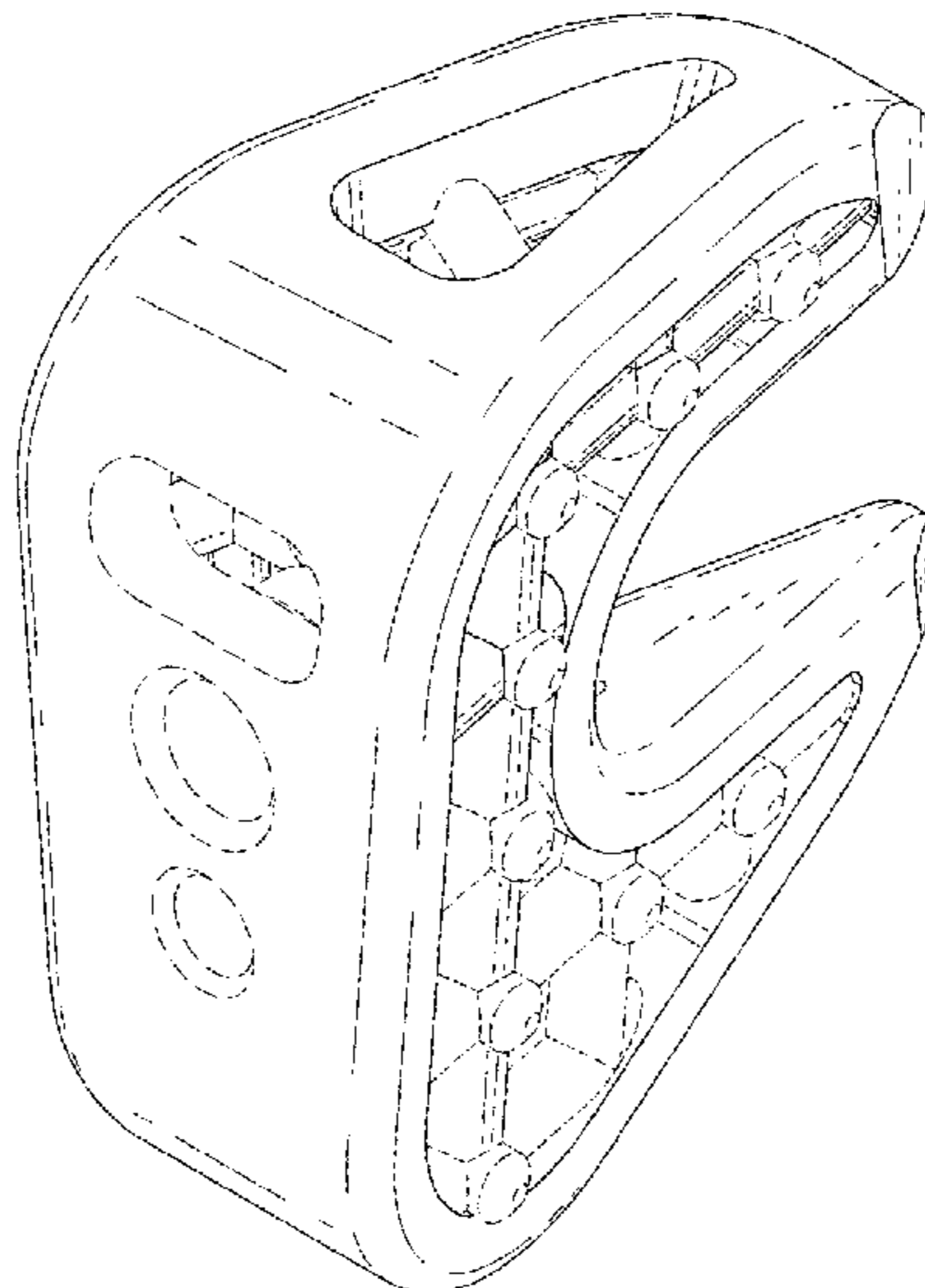

(56)

References Cited

U.S. PATENT DOCUMENTS

2009/0088849 A1* 4/2009 Armstrong A61F 2/4455
623/17.16
2009/0105831 A1* 4/2009 Jones A61B 17/7059
623/17.16
2010/0249935 A1* 9/2010 Slivka A61F 2/4465
623/17.16
2014/0228959 A1* 8/2014 Niemiec A61F 2/4455
623/17.16

* cited by examiner

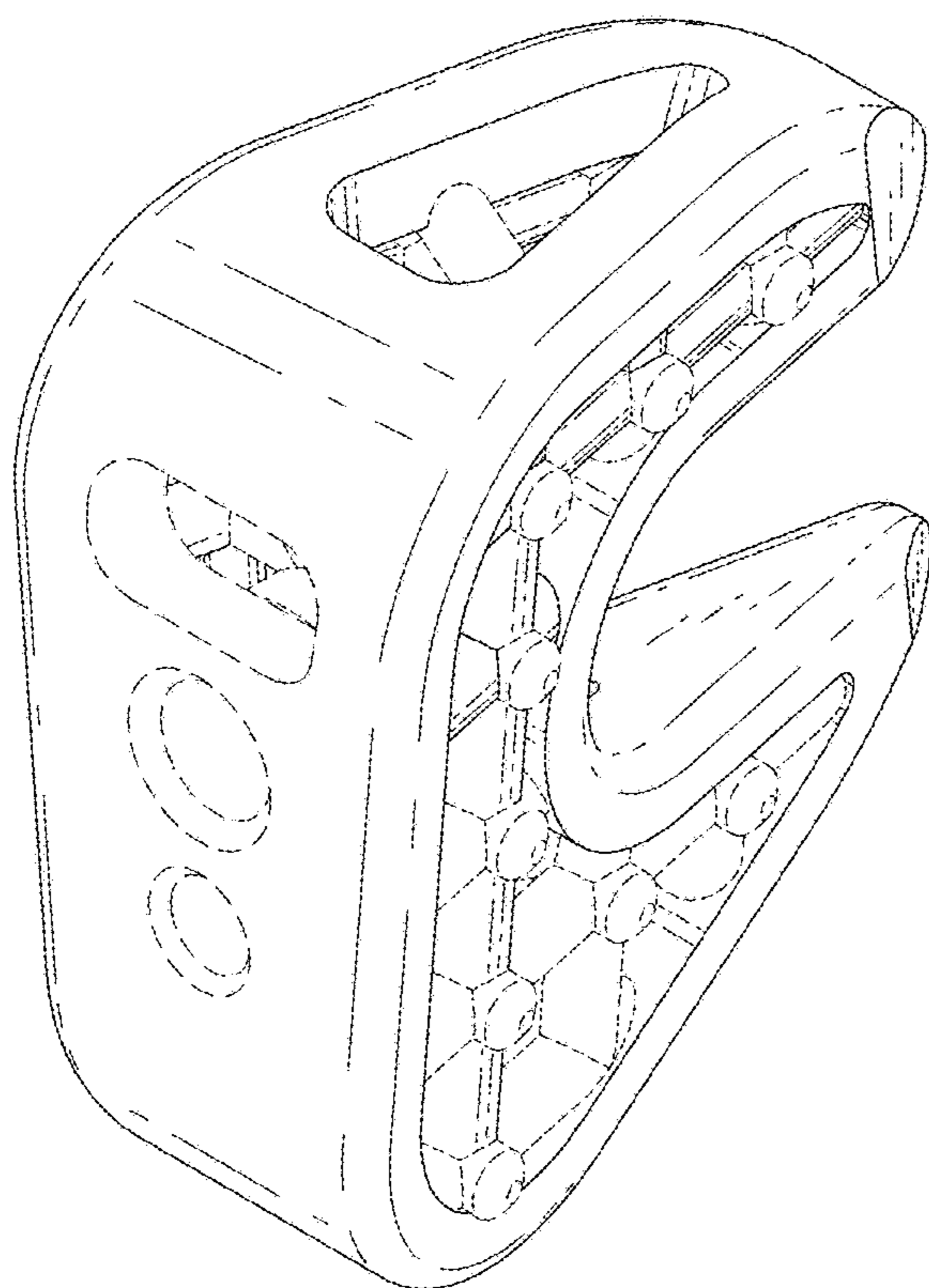

FIG. 1

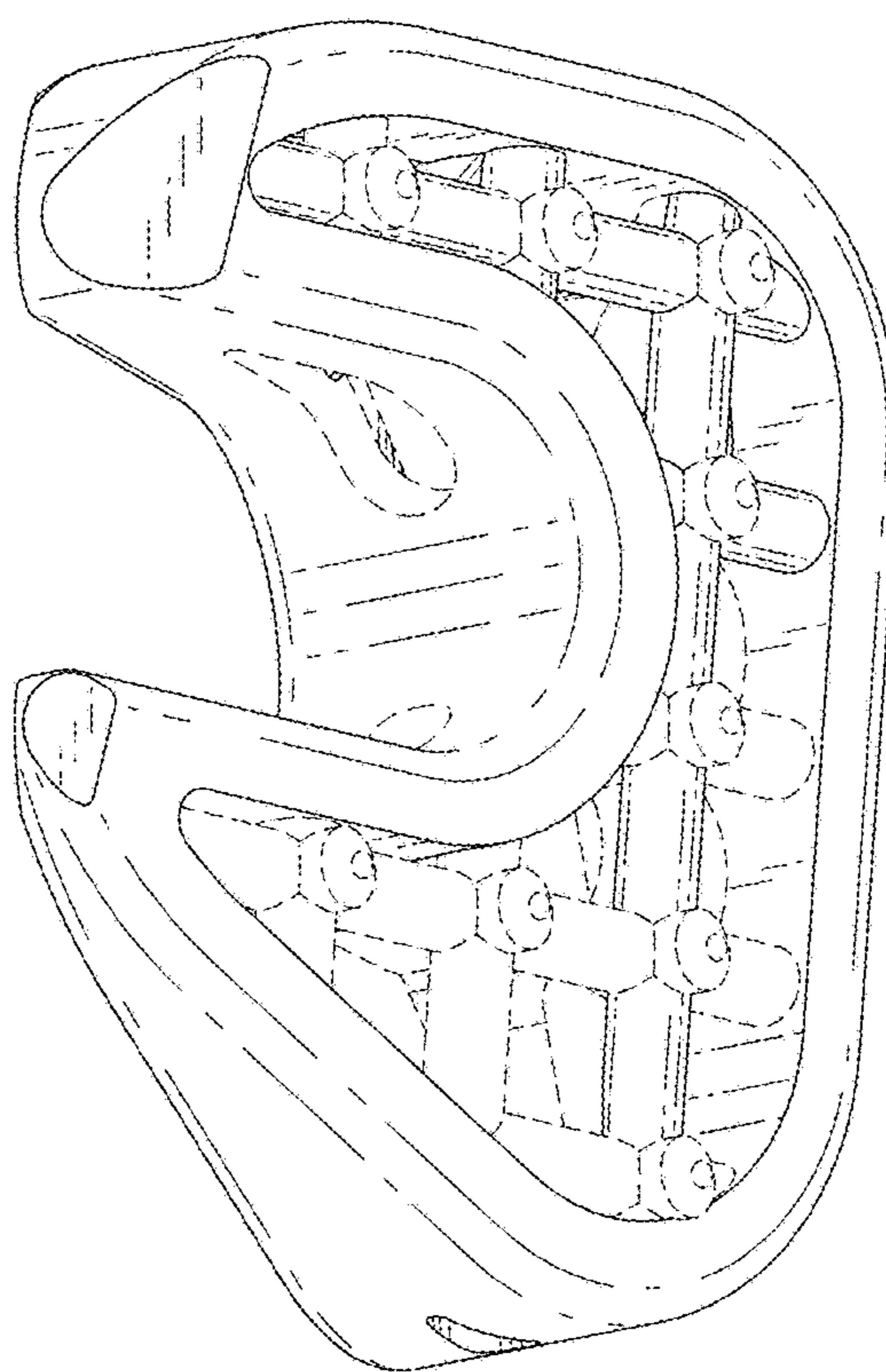

FIG. 2

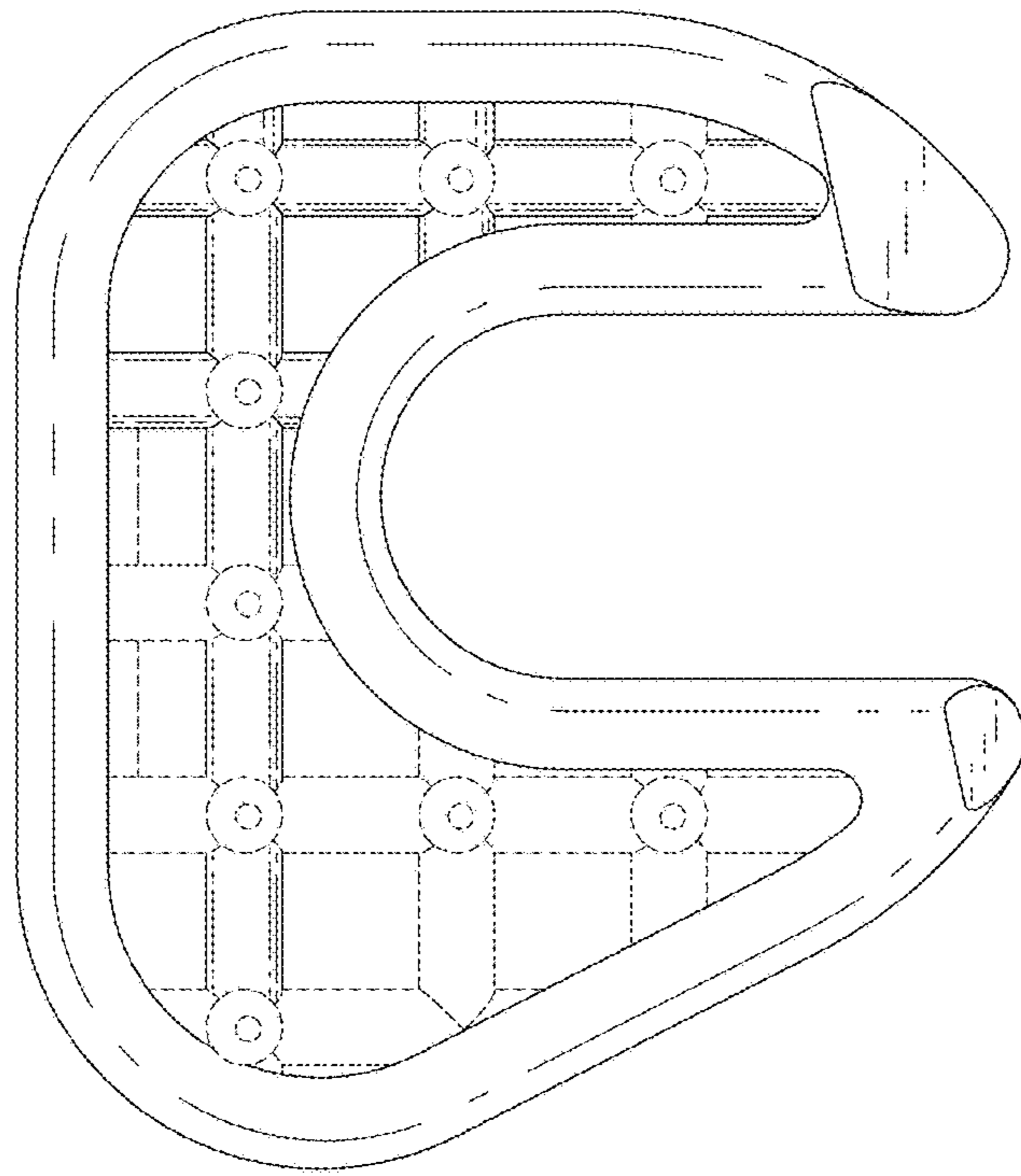

FIG. 3

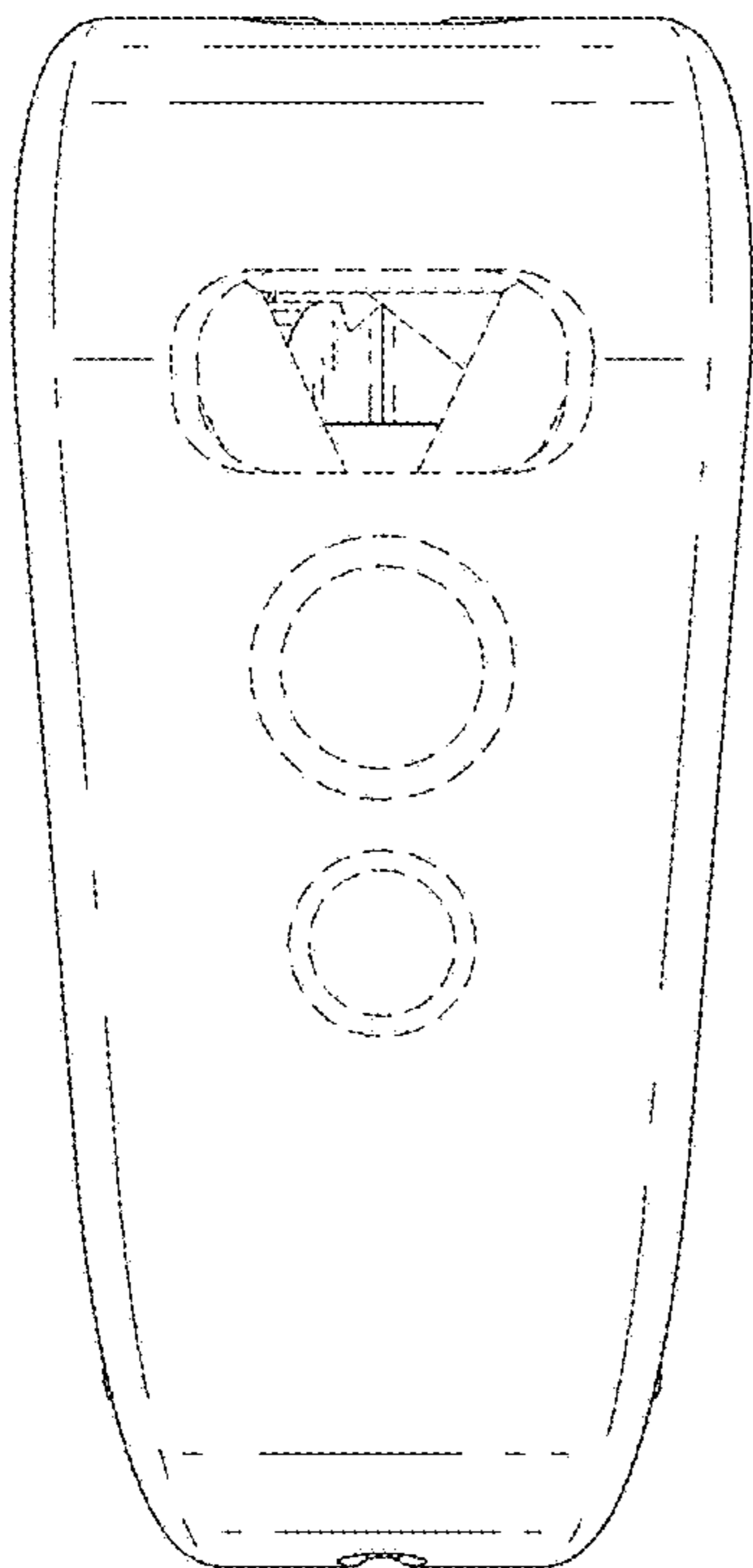

FIG. 4

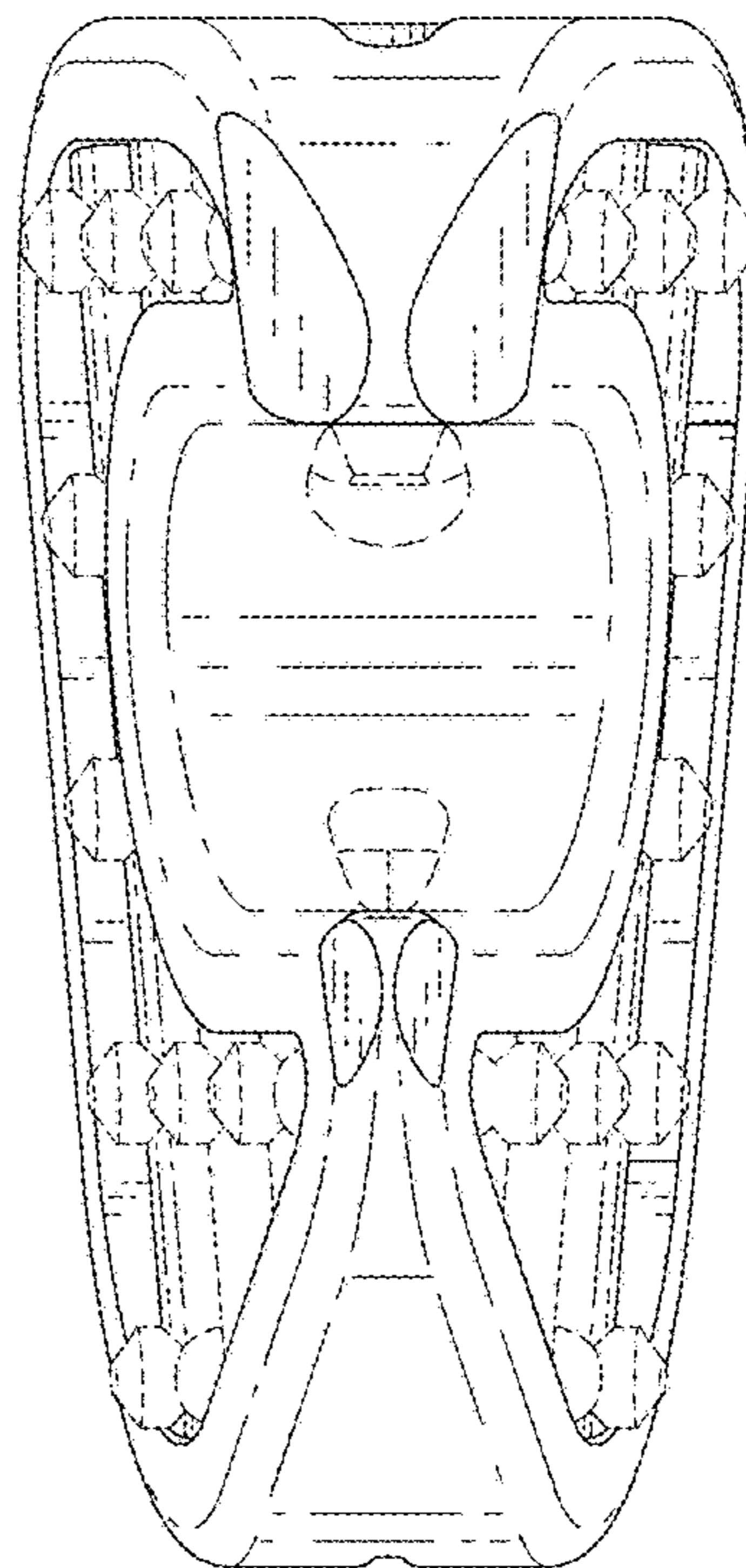

FIG. 5

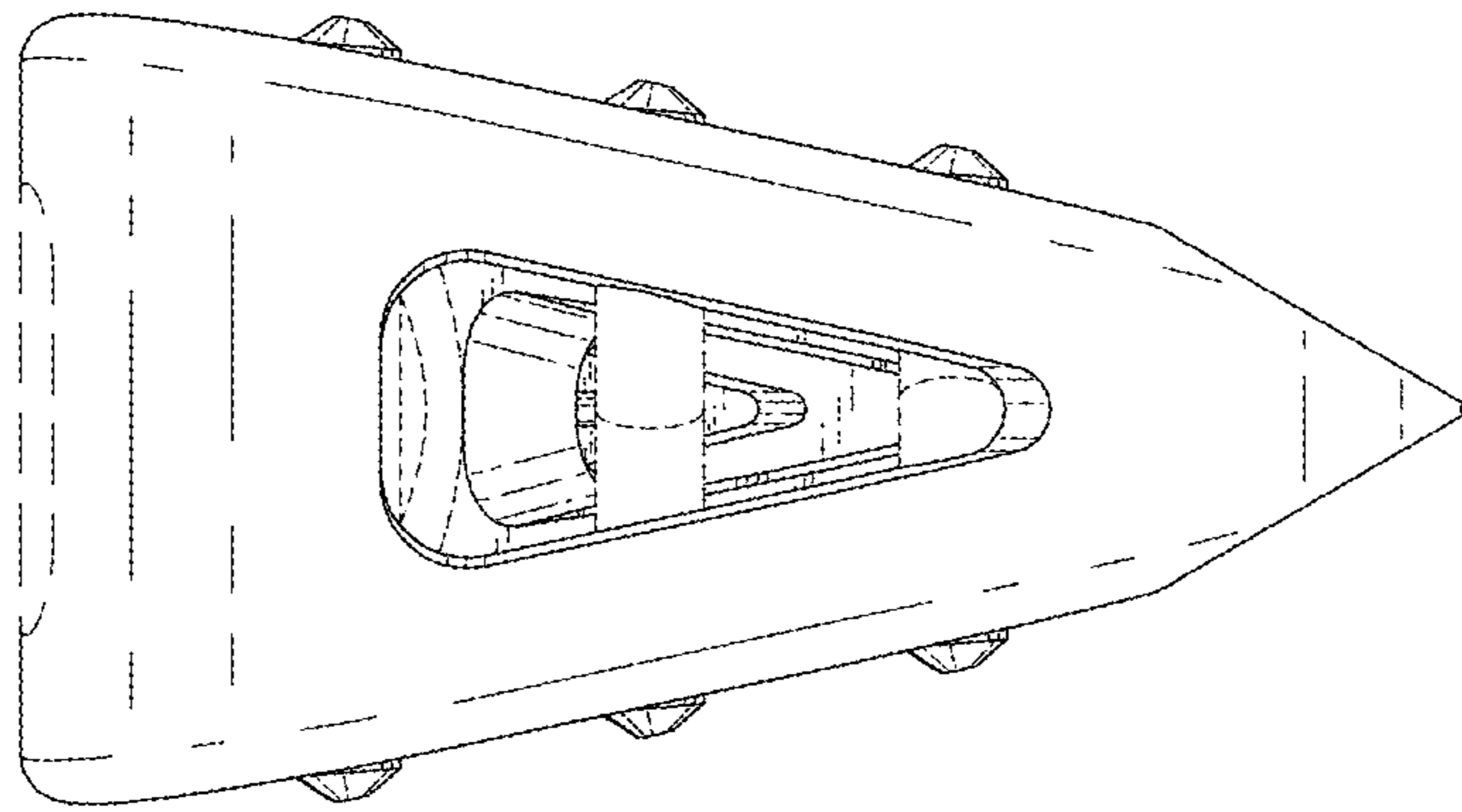

FIG. 6

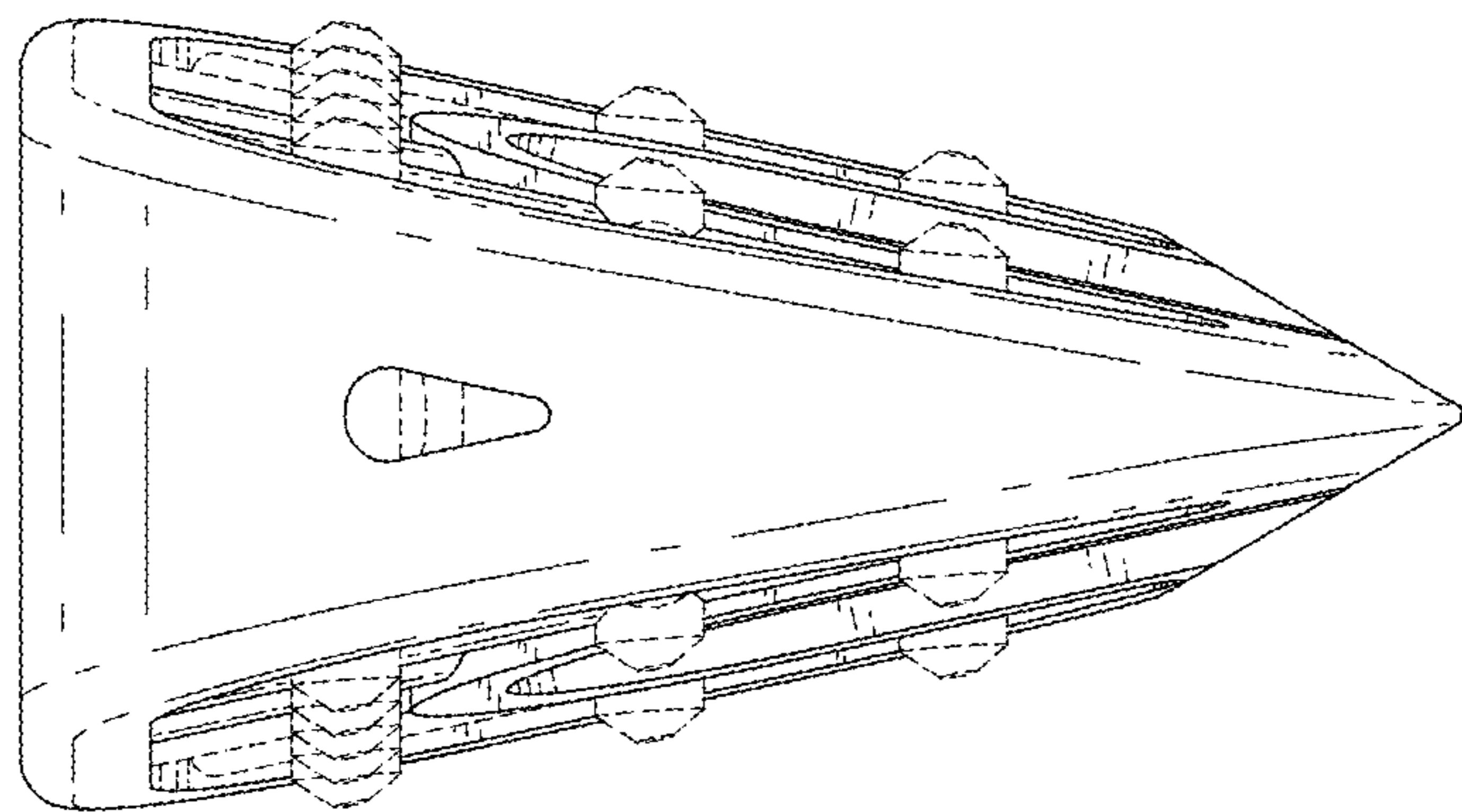

FIG. 7