



US00D832427S

(12) **United States Design Patent** (10) **Patent No.:** **US D832,427 S**
Svantesson et al. (45) **Date of Patent:** **** Oct. 30, 2018**

(54) **HEAT AND MOISTURE EXCHANGER BASE PLATE**

(71) Applicant: **Atos Medical AB**, Horby (SE)

(72) Inventors: **Lars Svantesson**, Horby (SE); **Richard Falkenberg**, Horby (SE)

(73) Assignee: **Atos Medical AB** (SE)

(**) Term: **15 Years**

(21) Appl. No.: **29/573,360**

(22) Filed: **Aug. 4, 2016**

(30) **Foreign Application Priority Data**

Feb. 4, 2016 (EM) 002972281-0002
Feb. 4, 2016 (EM) 002972281-0003
Feb. 4, 2016 (EM) 002972281-0004

(51) **LOC (11) Cl.** **24-04**

(52) **U.S. Cl.**
USPC **D24/128**

(58) **Field of Classification Search**

USPC D24/108, 111, 118, 127, 128; D9/696,
D9/707, 709
CPC A61M 16/066; A61M 16/0465; A61M
16/1045; A61M 1/0001; A61M 3/0262;
A61F 2/203; A61F 5/44; A61F 5/441;
A61F 5/445; A61F 5/448; A61J 1/10;
B65D 33/14; B65D 33/007; B65D
81/3266

See application file for complete search history.

(56) **References Cited**

U.S. PATENT DOCUMENTS

D398,990 S * 9/1998 Briggs D24/118
D516,212 S * 2/2006 Persson D24/128
D533,660 S * 12/2006 Persson D24/128
8,628,507 B1 * 1/2014 Carroll A61F 13/141
604/346

(Continued)

OTHER PUBLICATIONS

Provox Luna Base Plate found online [Jun. 17, 2017]—<http://www.atosmedical.us/product/provox-luna/>.*

Primary Examiner — Brandon M Rosati

Assistant Examiner — John A. Voytek

(74) *Attorney, Agent, or Firm* — Fishman Stewart PLLC

(57) **CLAIM**

The ornamental design for a heat and moisture exchanger base plate, as shown and described.

DESCRIPTION

FIG. 1 is a perspective view of a first embodiment; FIG. 2 is a front view of a first embodiment; FIG. 3 is a back view of a first embodiment; FIG. 4 is a left side view of a first embodiment; FIG. 5 is a right side view of a first embodiment; FIG. 6 is a top view of a first embodiment; FIG. 7 is a bottom view of a first embodiment; FIG. 8 is a perspective view of a second embodiment; FIG. 9 is a front view of a second embodiment; FIG. 10 is a back view of a second embodiment; FIG. 11 is a left side view of a second embodiment; FIG. 12 is a right side view of a second embodiment; FIG. 13 is a top view of a second embodiment; FIG. 14 is a bottom view of a second embodiment; FIG. 15 is a perspective view of a third embodiment; FIG. 16 is a front view of a third embodiment; FIG. 17 is a back view of a third embodiment; FIG. 18 is a left side view of a third embodiment; FIG. 19 is a right side view of a third embodiment; FIG. 20 is a top view of a third embodiment; and, FIG. 21 is a bottom view of a third embodiment.

In the drawings, the broken lines depict environmental subject matter only and form no part of the claimed design. The dot and dashed boundary lines indicate a boundary between the claimed and unclaimed portions of the design.

1 Claim, 15 Drawing Sheets

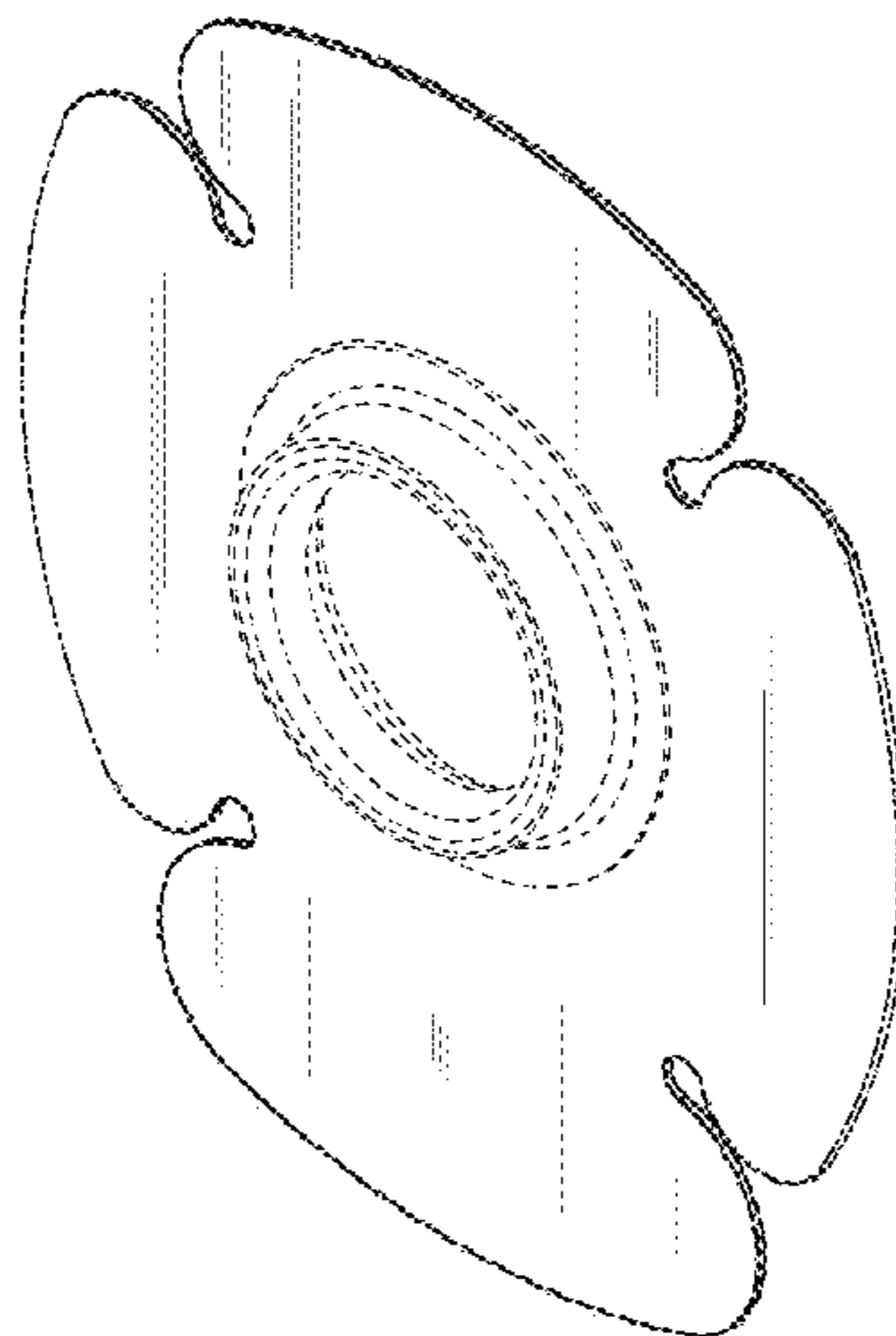

(56)

References Cited

U.S. PATENT DOCUMENTS

D786,425 S * 5/2017 Fahl D24/118
2011/0118684 A1 * 5/2011 Nguyen-DeMary A61F 5/448
604/344
2013/0192603 A1 * 8/2013 Leibitzki A61M 16/0468
128/205.29
2013/0192604 A1 * 8/2013 Persson A61M 16/047
128/207.16
2013/0213404 A1 * 8/2013 Leibitzki A61M 16/047
128/207.14
2013/0304008 A1 * 11/2013 Hanuka A61F 5/4401
604/334
2014/0216445 A1 * 8/2014 Persson A61M 16/0465
128/201.13
2017/0156920 A1 * 6/2017 Hunt A61F 5/448

* cited by examiner

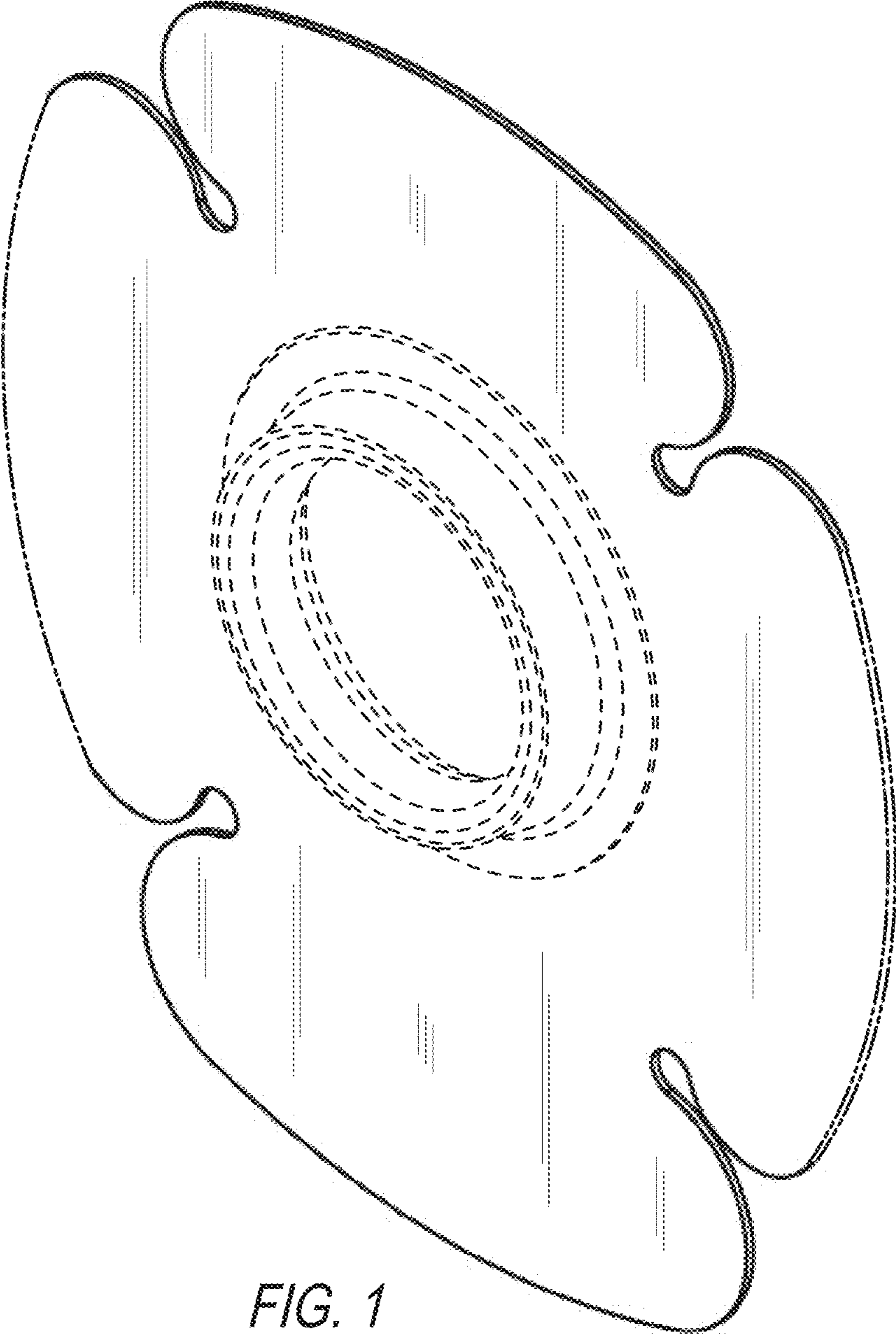

FIG. 1

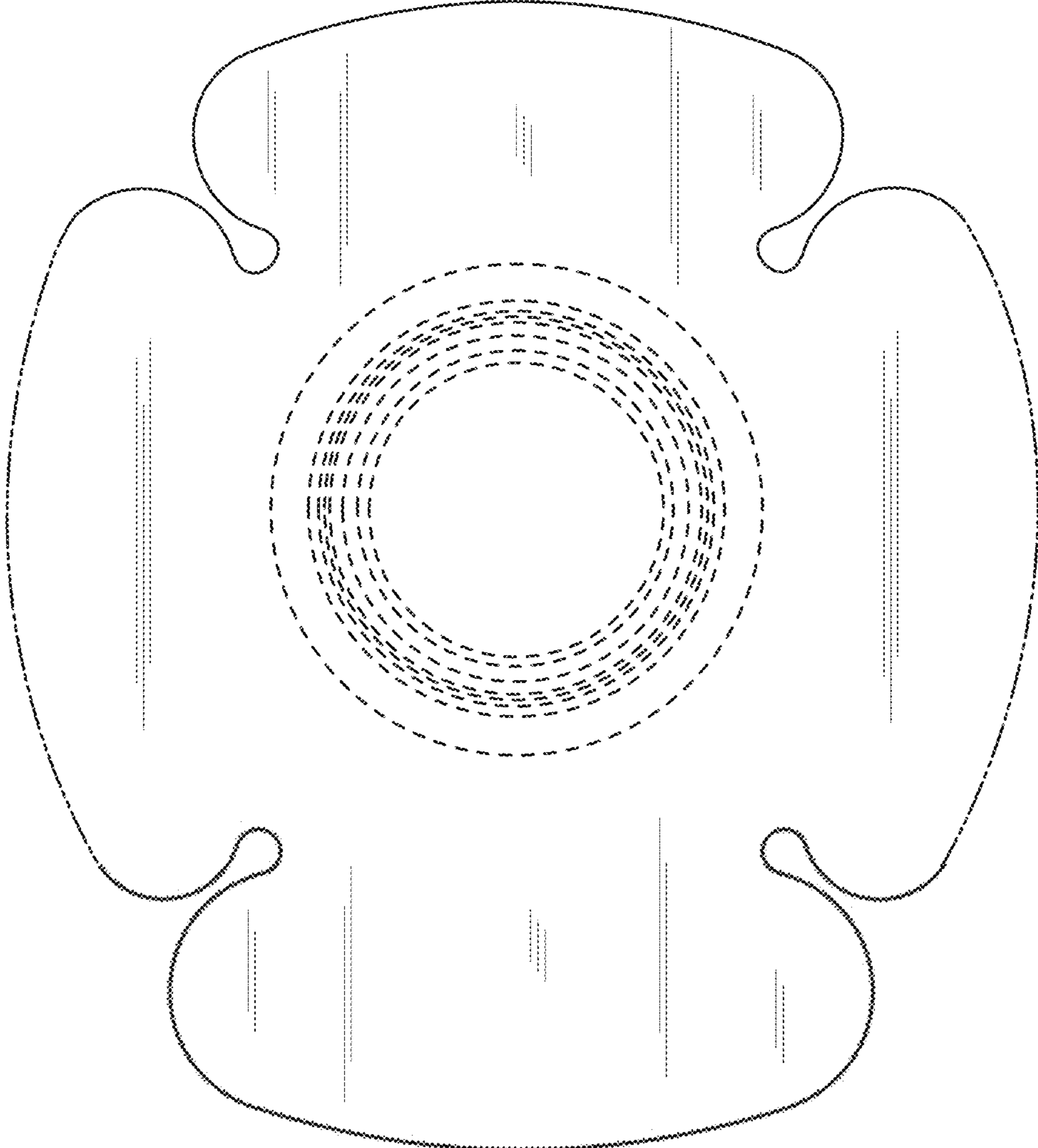

FIG. 2

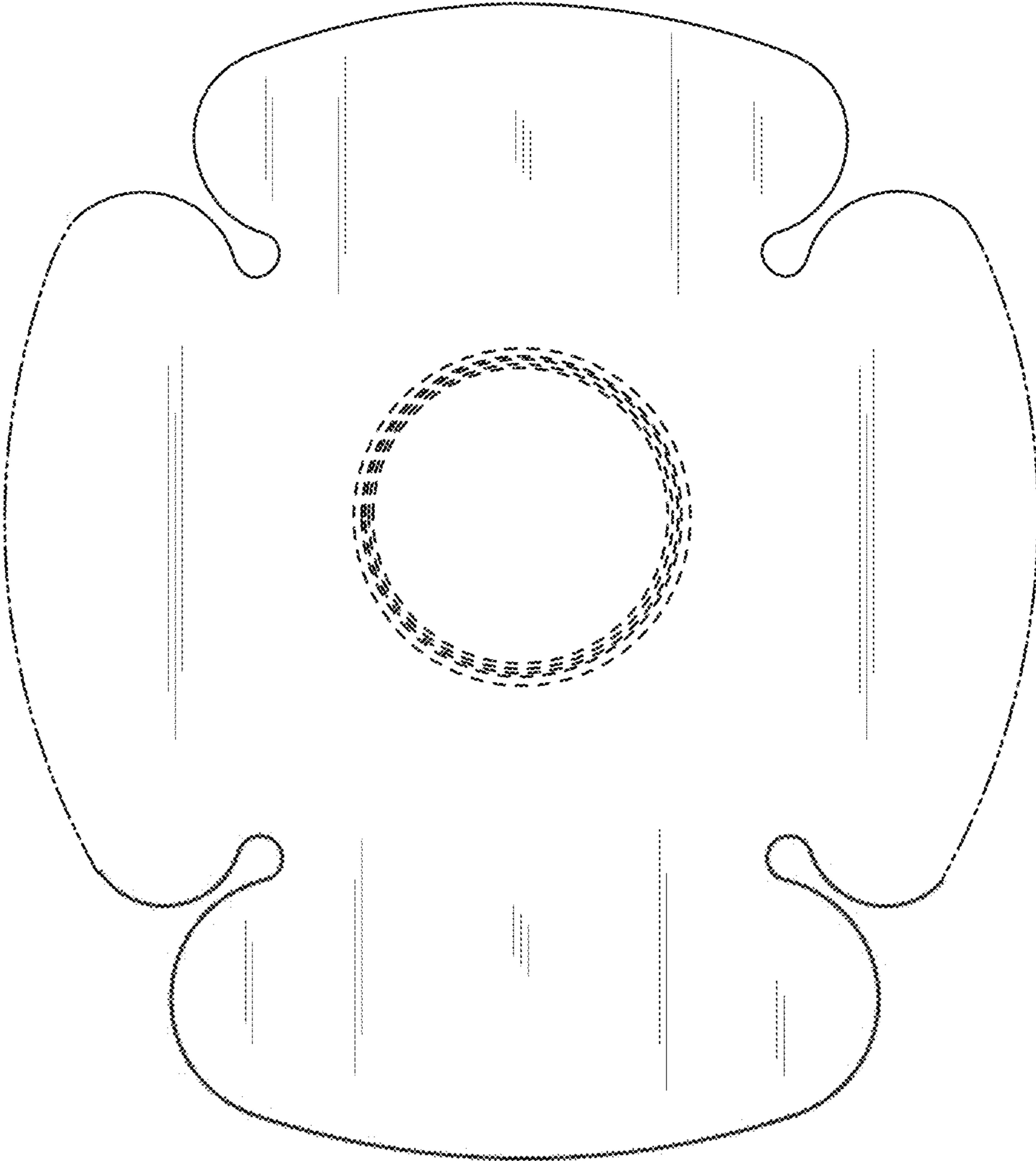

FIG. 3

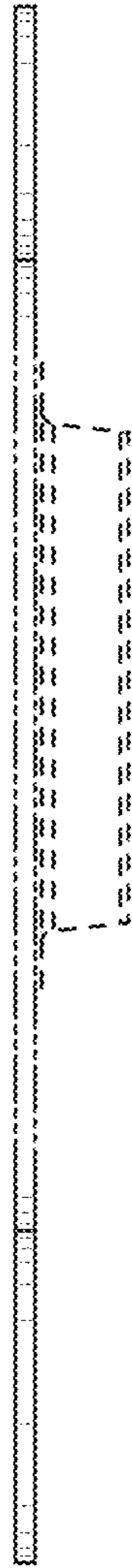

FIG. 4

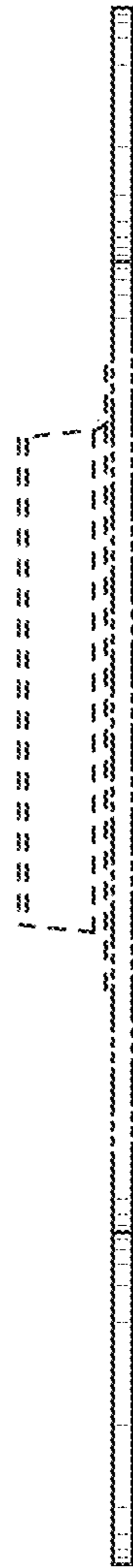

FIG. 5

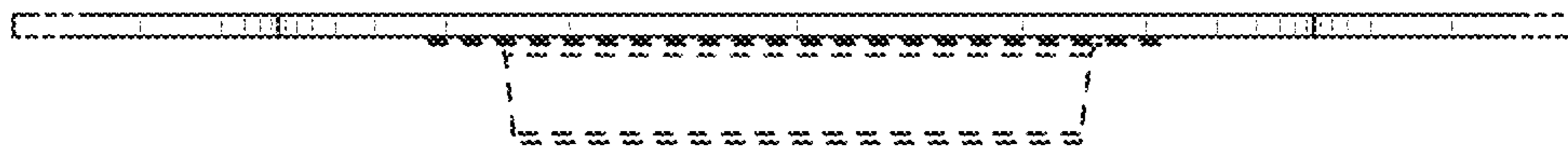

FIG. 6

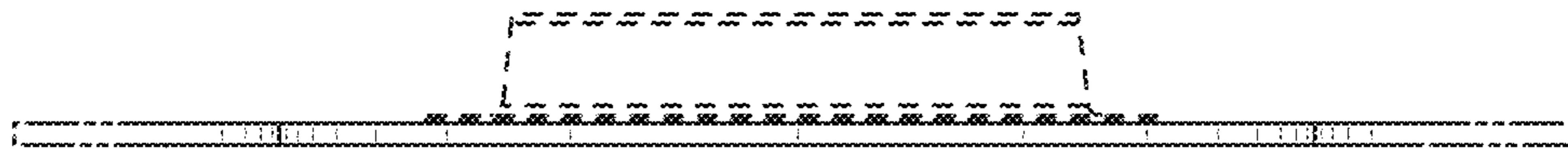

FIG. 7

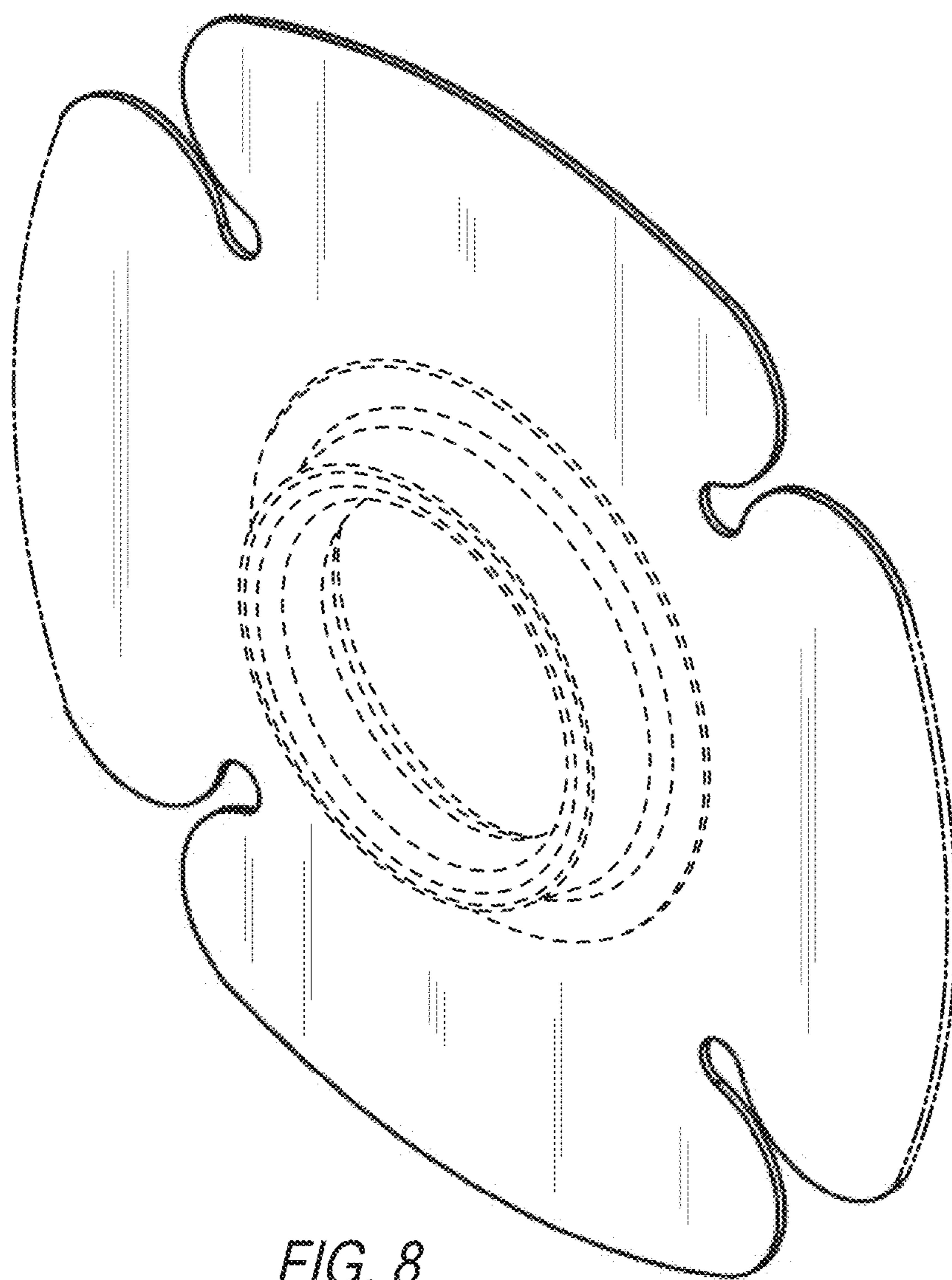

FIG. 8

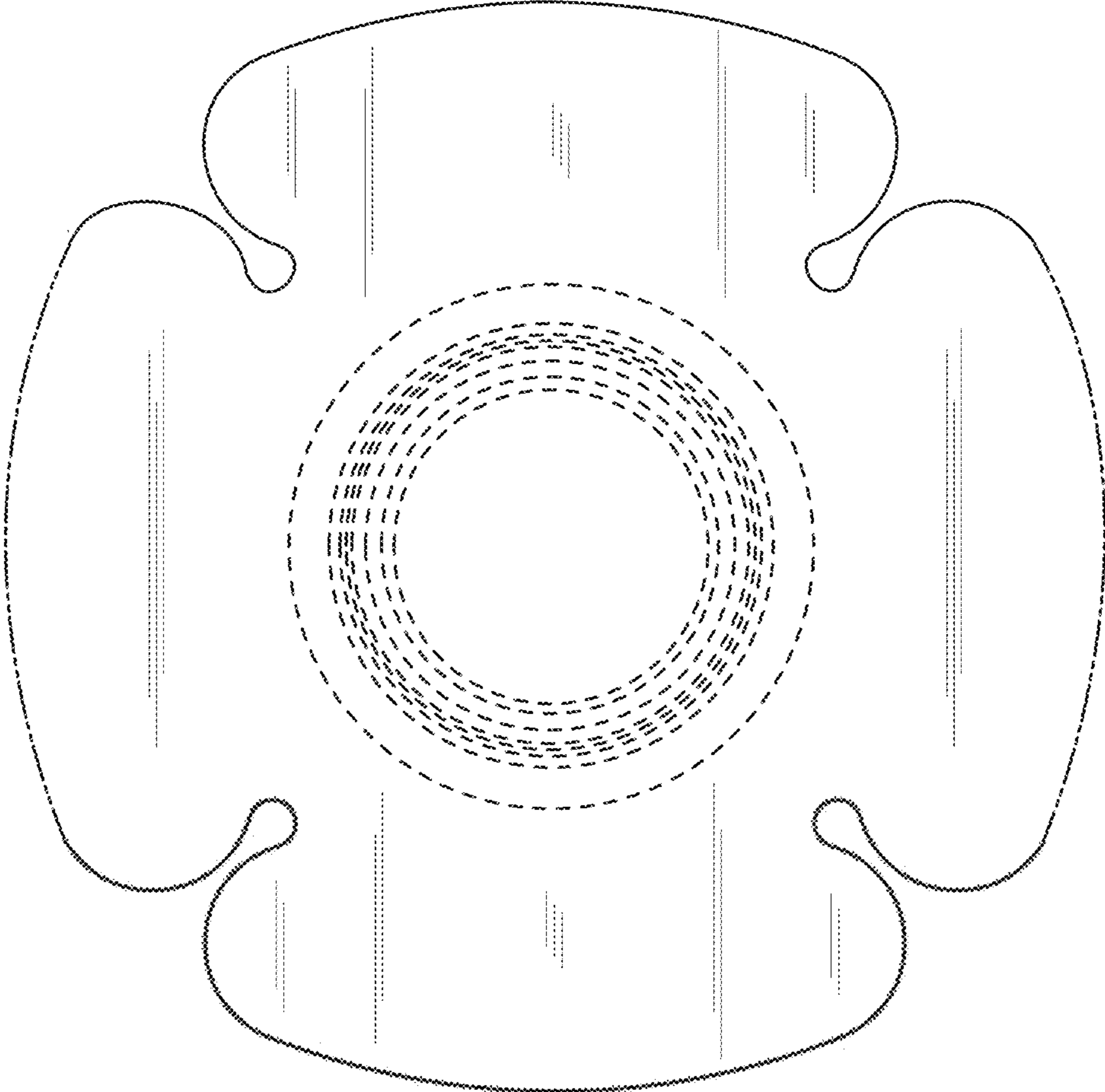

FIG. 9

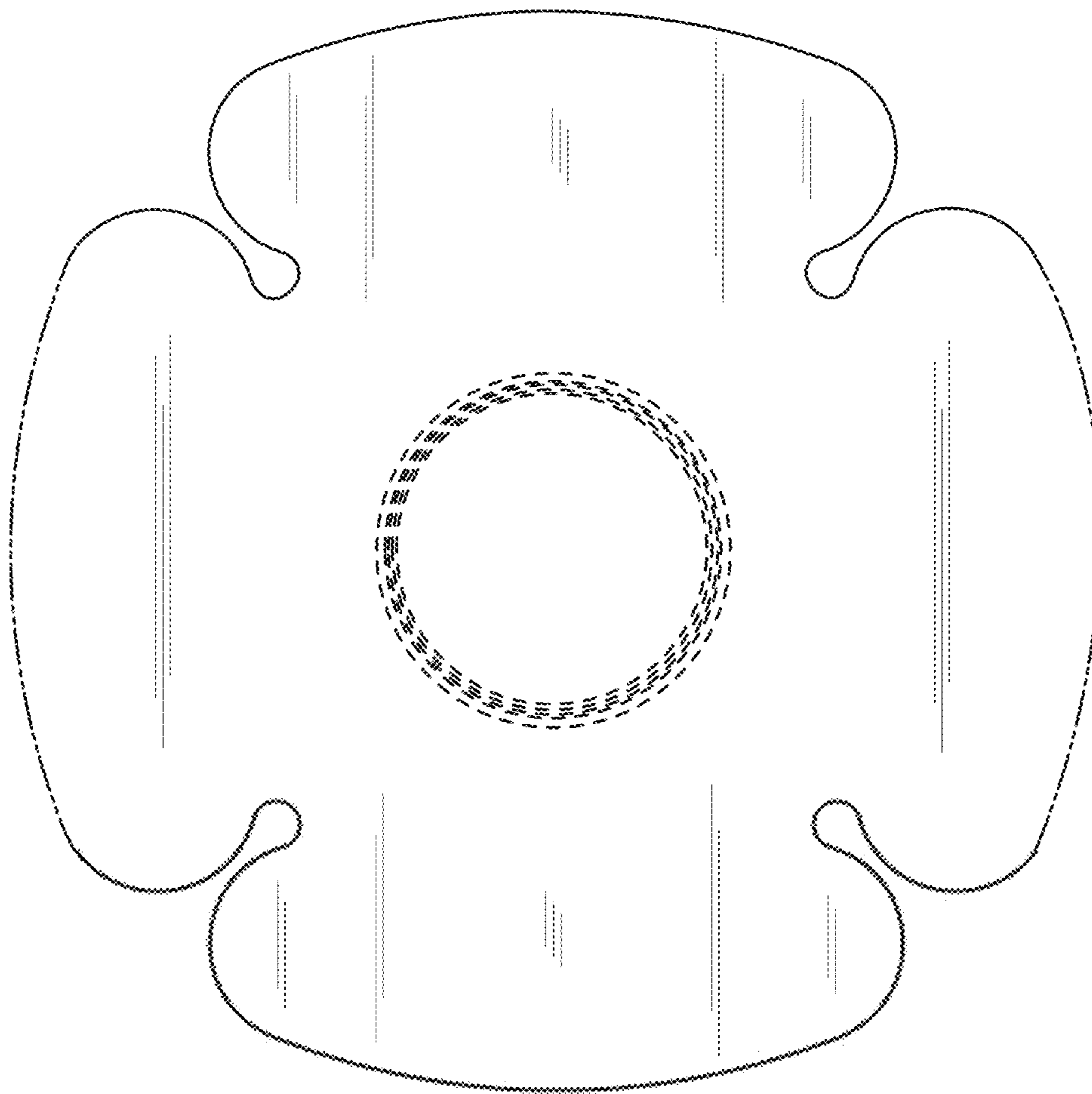

FIG. 10

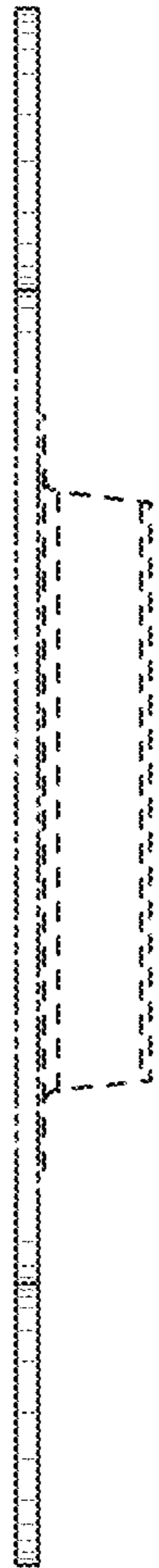

FIG. 11

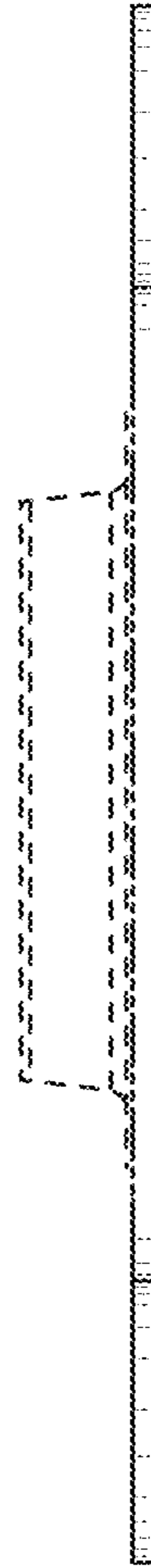

FIG. 12

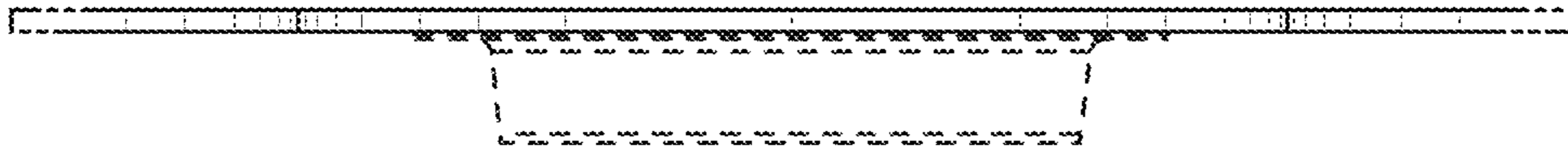

FIG. 13

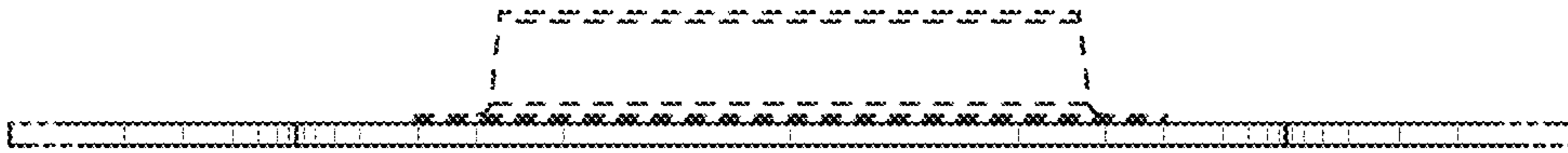

FIG. 14

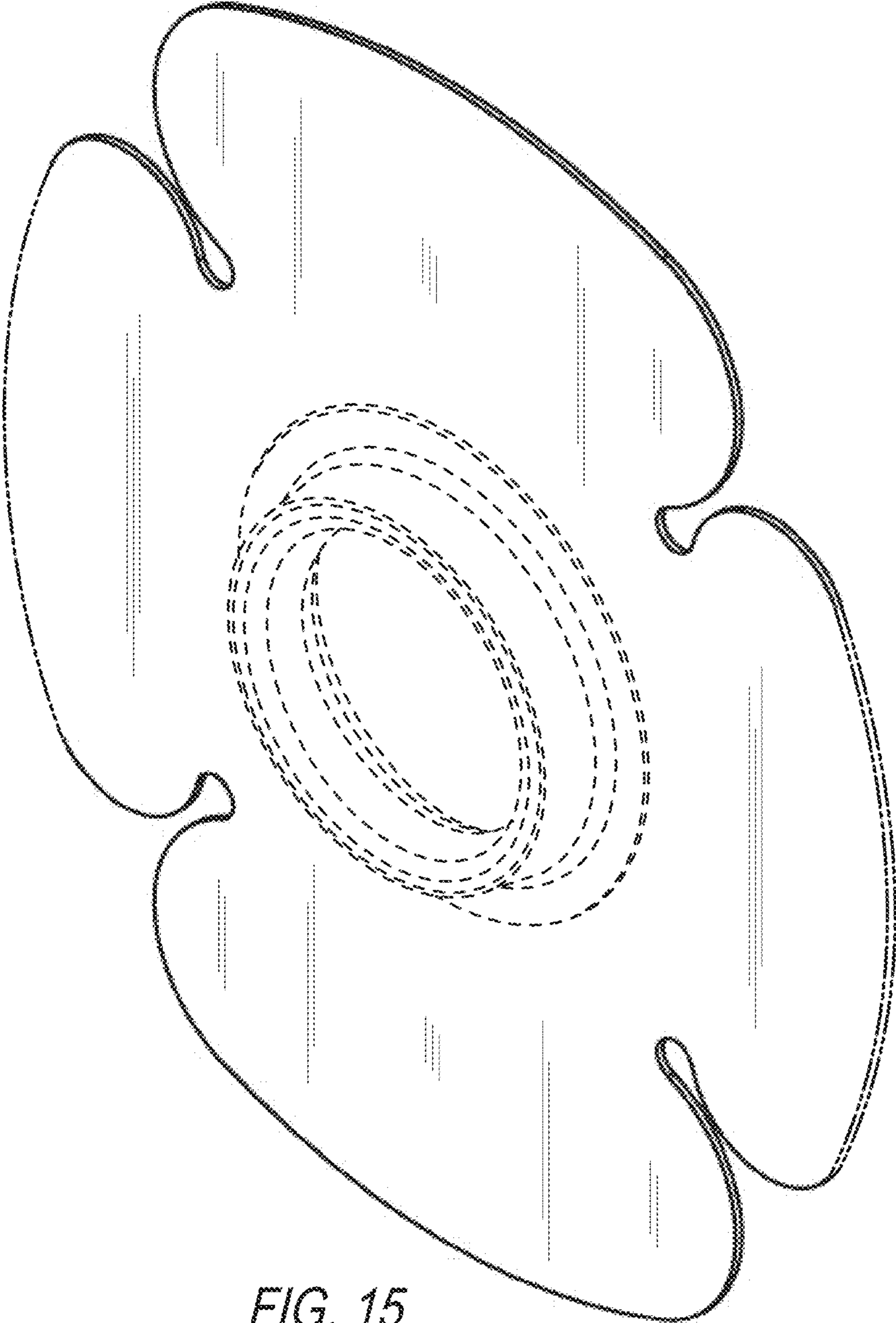

FIG. 15

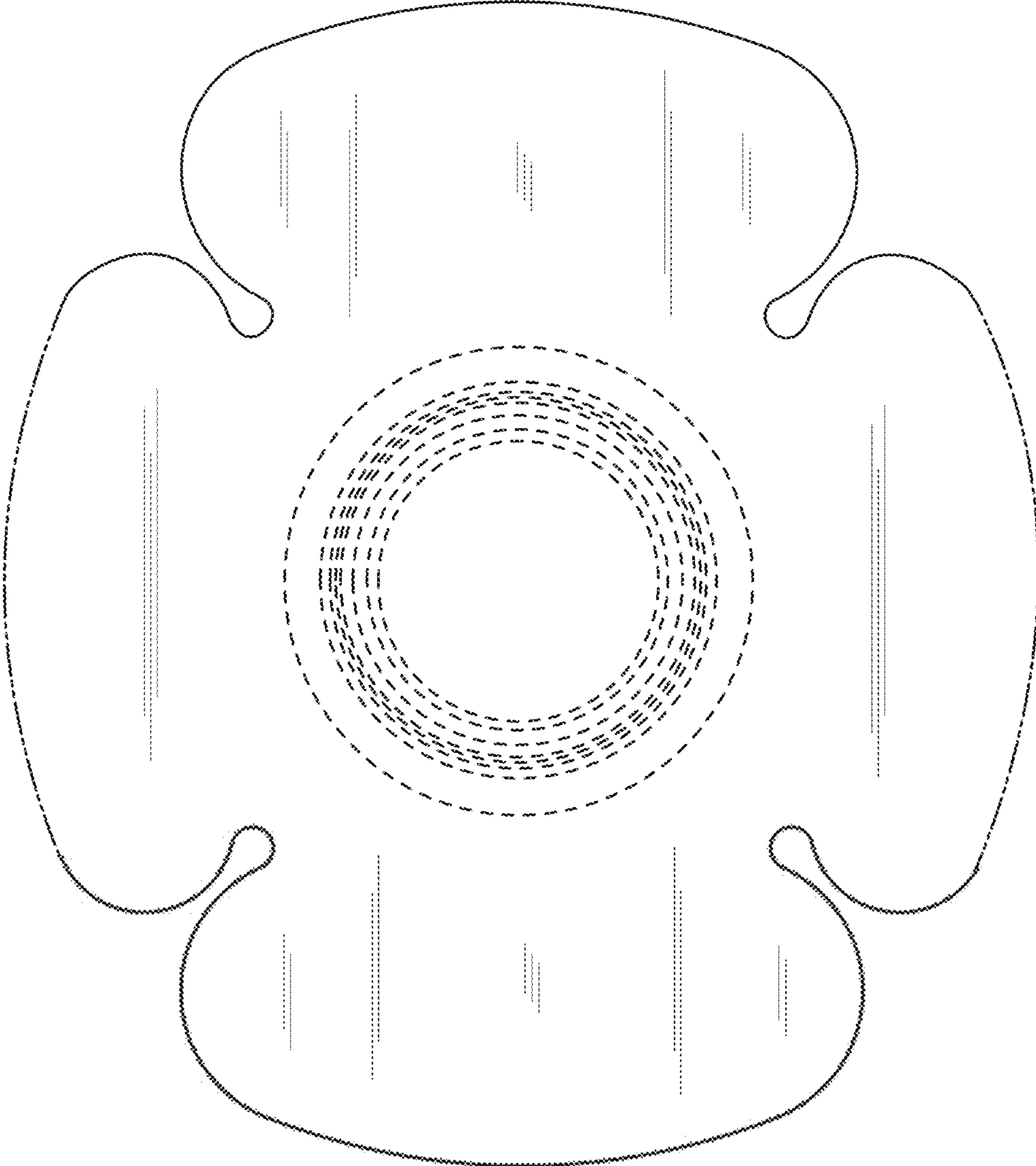

FIG. 16

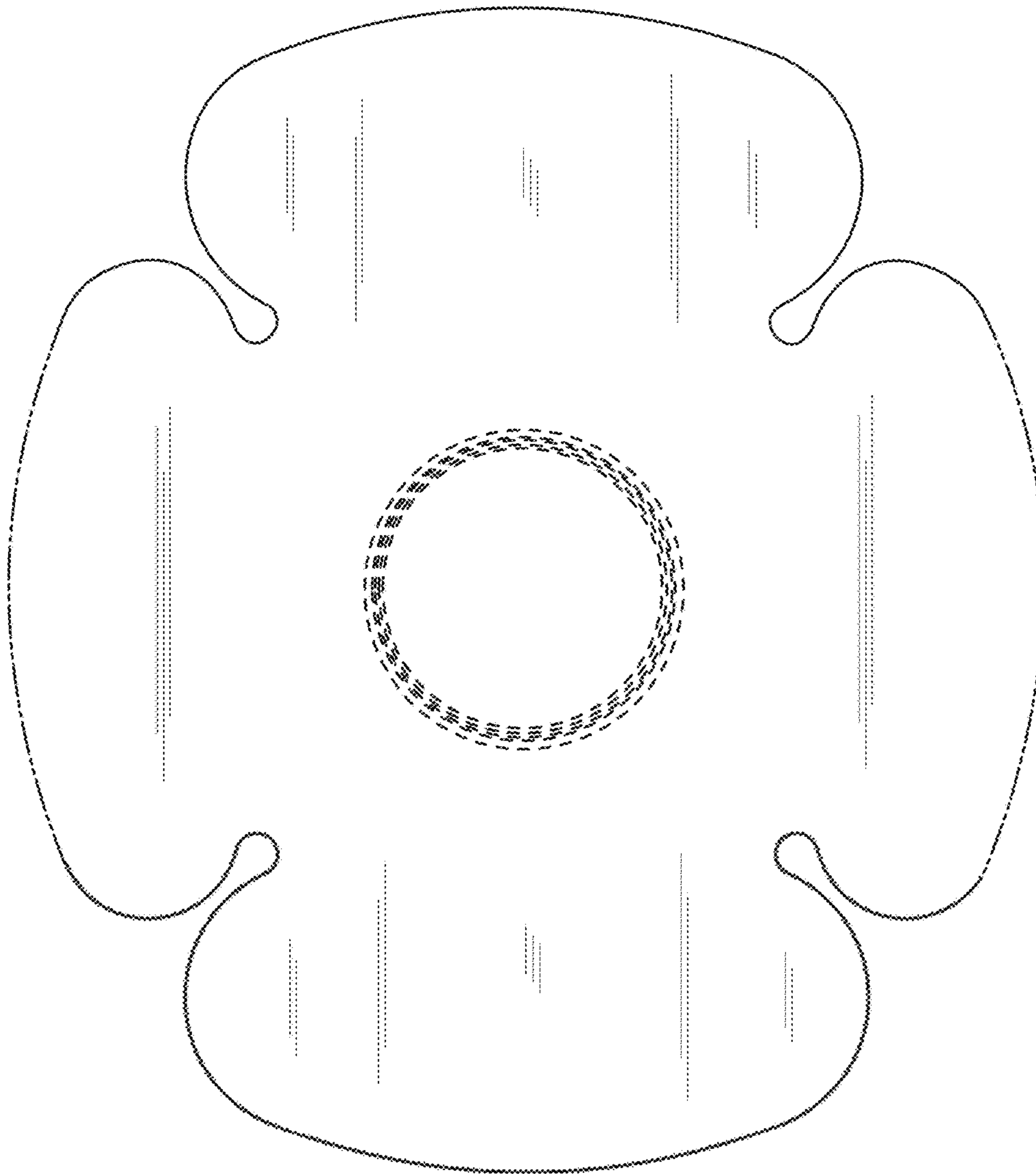

FIG. 17

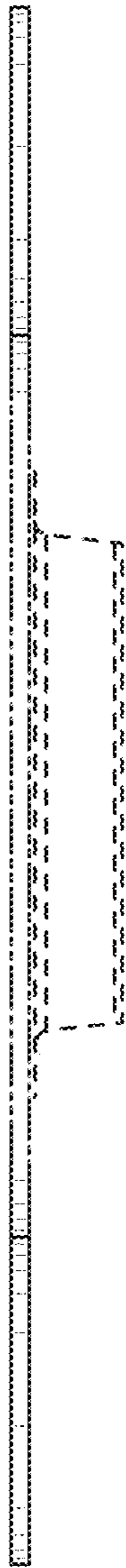

FIG. 18

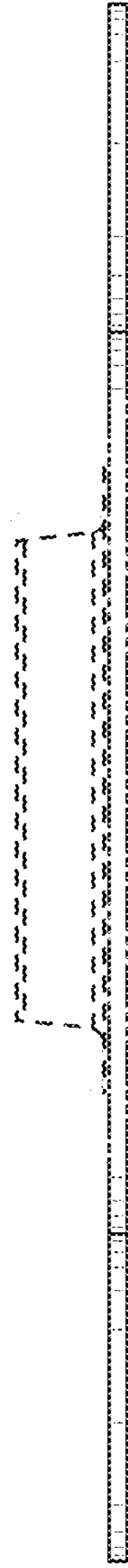

FIG. 19

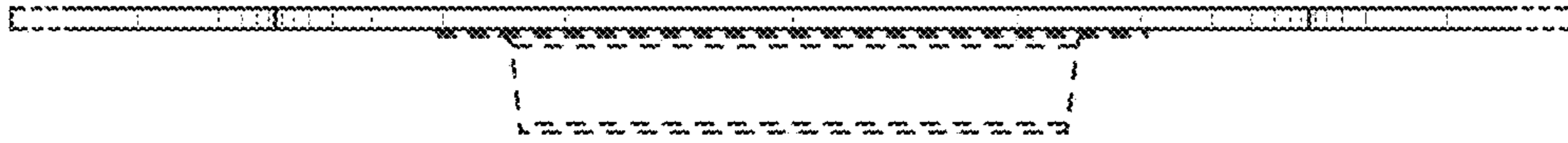

FIG. 20

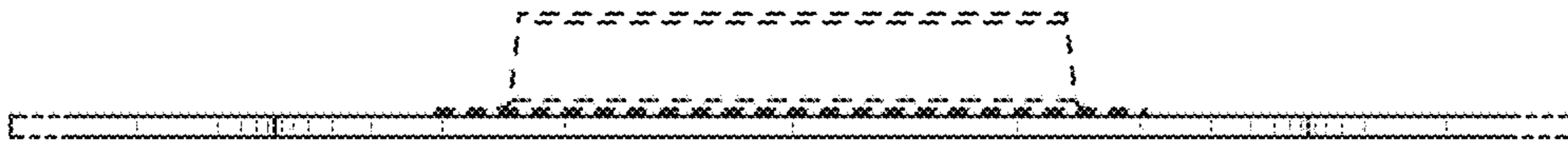

FIG. 21