



US00D832352S

(12) **United States Design Patent**
Cornell

(10) **Patent No.:** **US D832,352 S**
(45) **Date of Patent:** **** Oct. 30, 2018**

- (54) **SIGN**
- (71) Applicant: **George Cornell**, Poway, CA (US)
- (72) Inventor: **George Cornell**, Poway, CA (US)
- (**) Term: **15 Years**
- (21) Appl. No.: **29/597,089**
- (22) Filed: **Mar. 14, 2017**
- (51) **LOC (11) Cl.** **20-03**
- (52) **U.S. Cl.**
USPC **D20/29**
- (58) **Field of Classification Search**
USPC D1/121; D3/214, 232, 318; D5/63;
D9/759, 760; D20/19, 22-29, 40;
D24/171, 189, 190; D8/51
CPC G09F 1/00; G09F 1/02; G09F 1/04; G09F
1/06; G09F 1/08; G09F 1/10; G09F 3/00;
G09F 3/02; G09F 2003/0201; G09F
2003/0202; G09F 2003/0208; G09F
2003/0264; G09F 2003/0266; G09F
2003/0267; G09F 2003/0269; G09F
2003/0276; G09F 2003/0277; G09F 7/00;
G09F 9/00; G09F 9/30; G09F 9/302;
G09F 19/00
See application file for complete search history.

- (56) **References Cited**
U.S. PATENT DOCUMENTS
D128,437 S * 7/1941 Moskowitz D19/4
2,832,176 A * 4/1958 Vergeer A47G 1/141
116/63 P
3,228,139 A * 1/1966 Lohnes A63H 37/00
446/148

D319,259 S *	8/1991	Weir	D19/1
D497,178 S *	10/2004	Weir	D19/2
D555,205 S *	11/2007	Strong	D20/10
D588,228 S *	3/2009	Swan	D22/109
D809,434 S *	2/2018	Le	D12/111
D811,185 S *	2/2018	Yuan	D8/51
D818,045 S *	5/2018	Hemphill	D20/40
2013/0081312 A1 *	4/2013	McFadden	G09F 21/026 40/586

* cited by examiner

Primary Examiner — Mary Ann Calabrese
Assistant Examiner — Catherine Ho
(74) *Attorney, Agent, or Firm* — Procopio Cory
Hargreaves and Savitch LLP

(57) **CLAIM**
I claim the ornamental design for a sign, as shown and described.

DESCRIPTION
FIG. 1 is a perspective view of a sign shown in an open position;
FIG. 2 is a front elevational view thereof;
FIG. 3 is a rear elevation view thereof;
FIG. 4 is a top plan view thereof;
FIG. 5 is a bottom plan view thereof;
FIG. 6 is a left elevational view thereof;
FIG. 7 is a right elevational view thereof;
FIG. 8 is a front elevational view of a sign shown in an closed position;
FIG. 9 is a rear elevation view thereof;
FIG. 10 is a top plan view thereof;
FIG. 11 is a bottom plan view thereof;
FIG. 12 is a left elevation view thereof; and,
FIG. 13 is a right elevational view thereof.

1 Claim, 3 Drawing Sheets

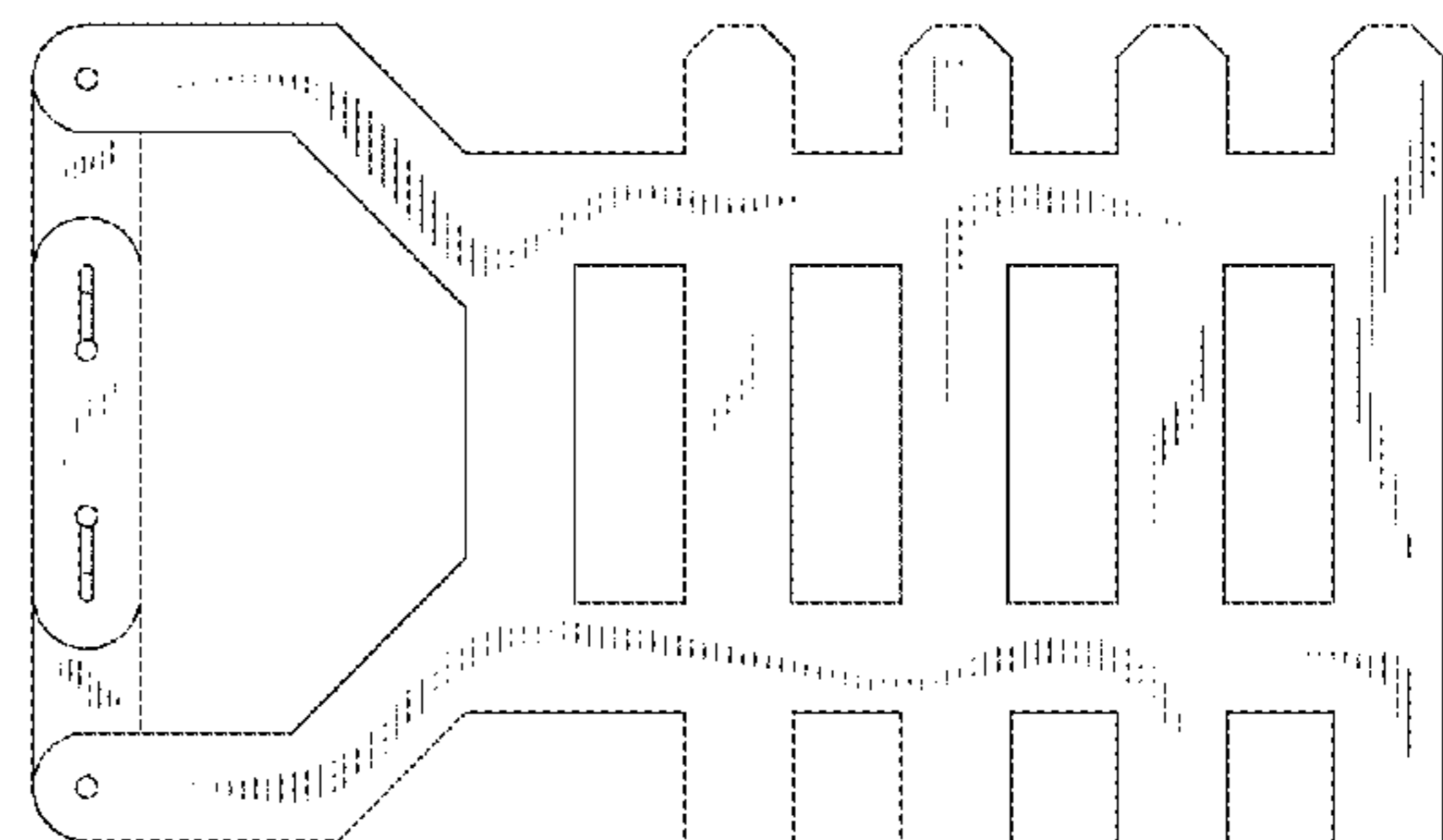
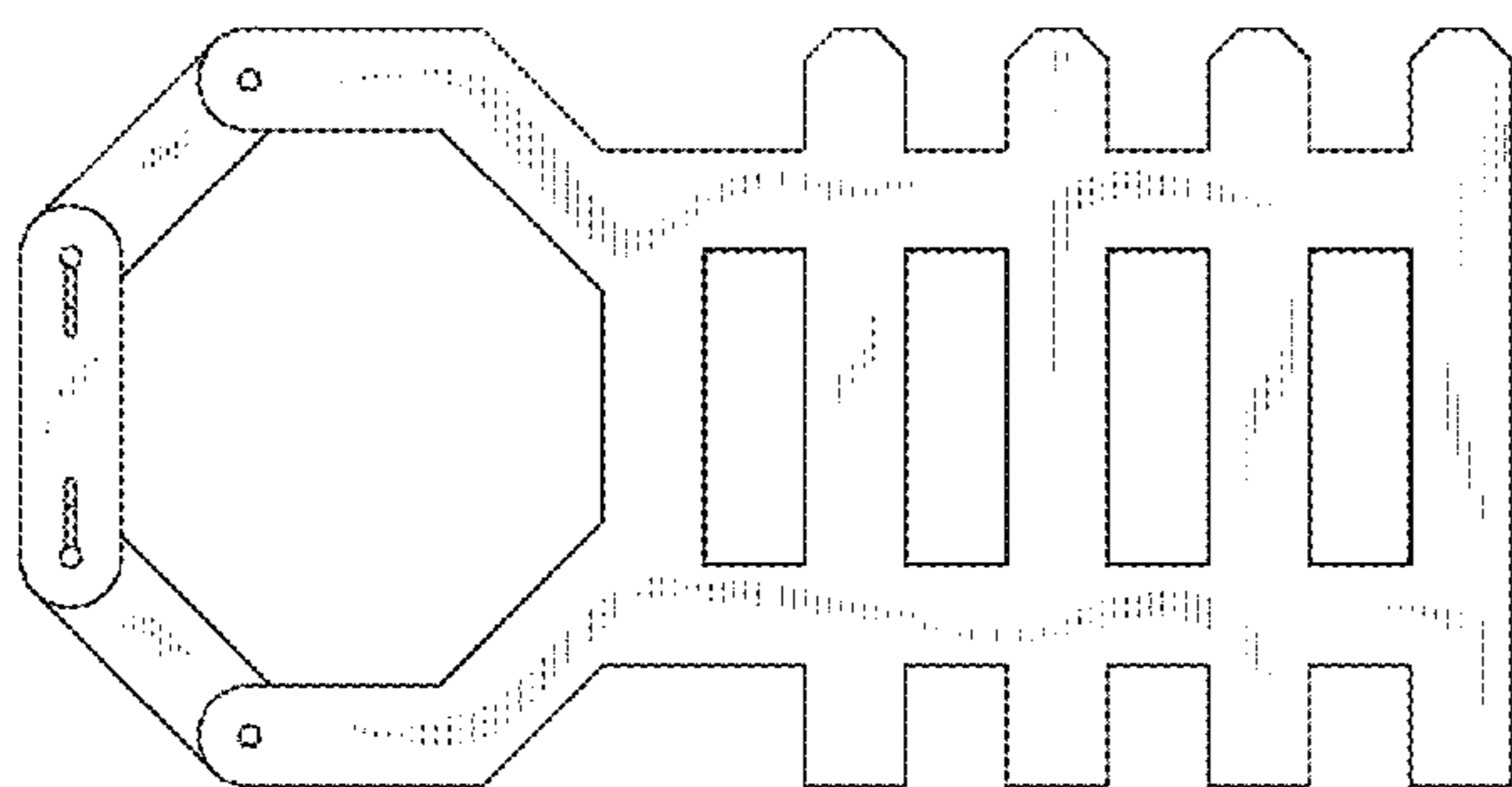

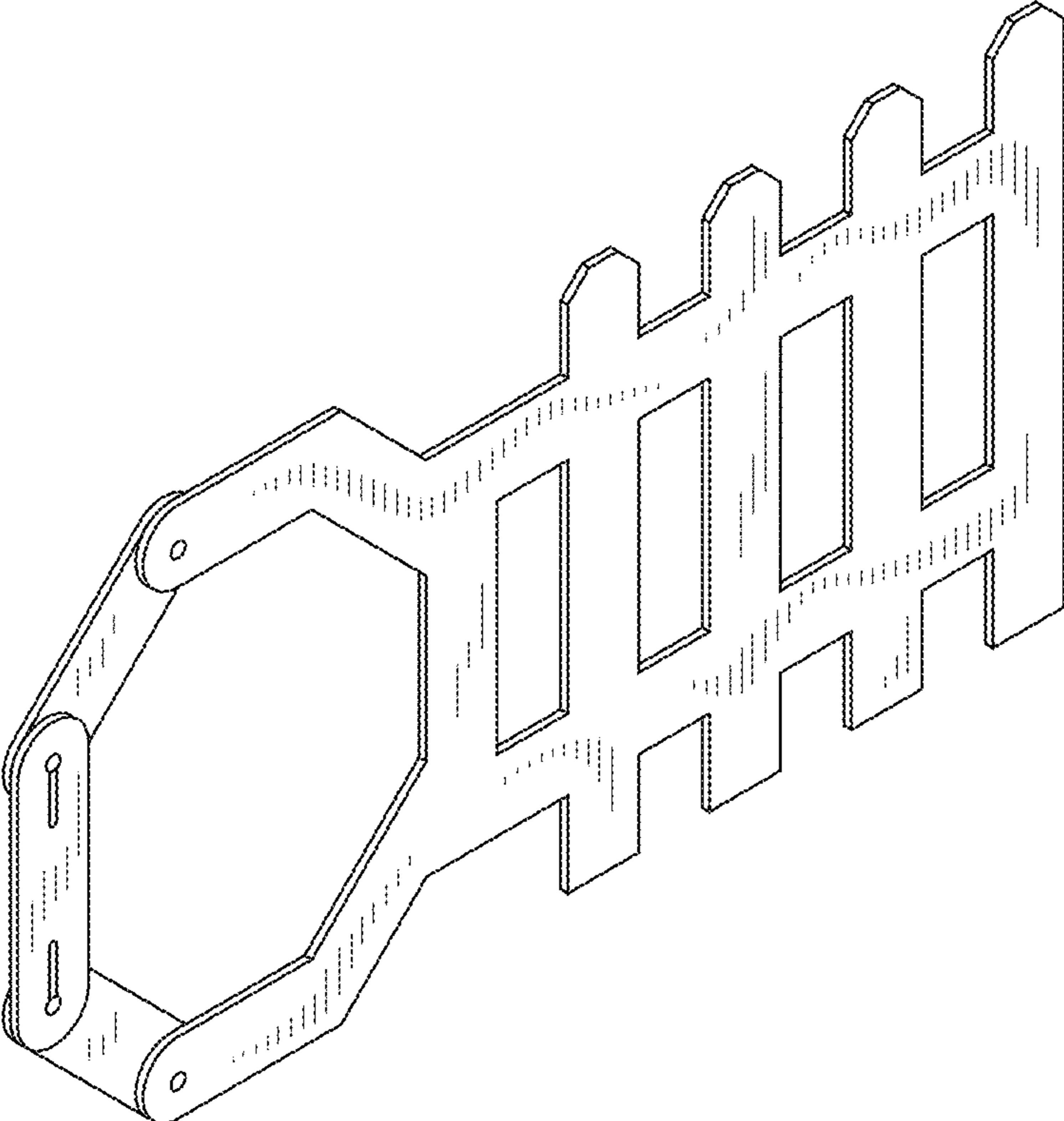

FIG. 1

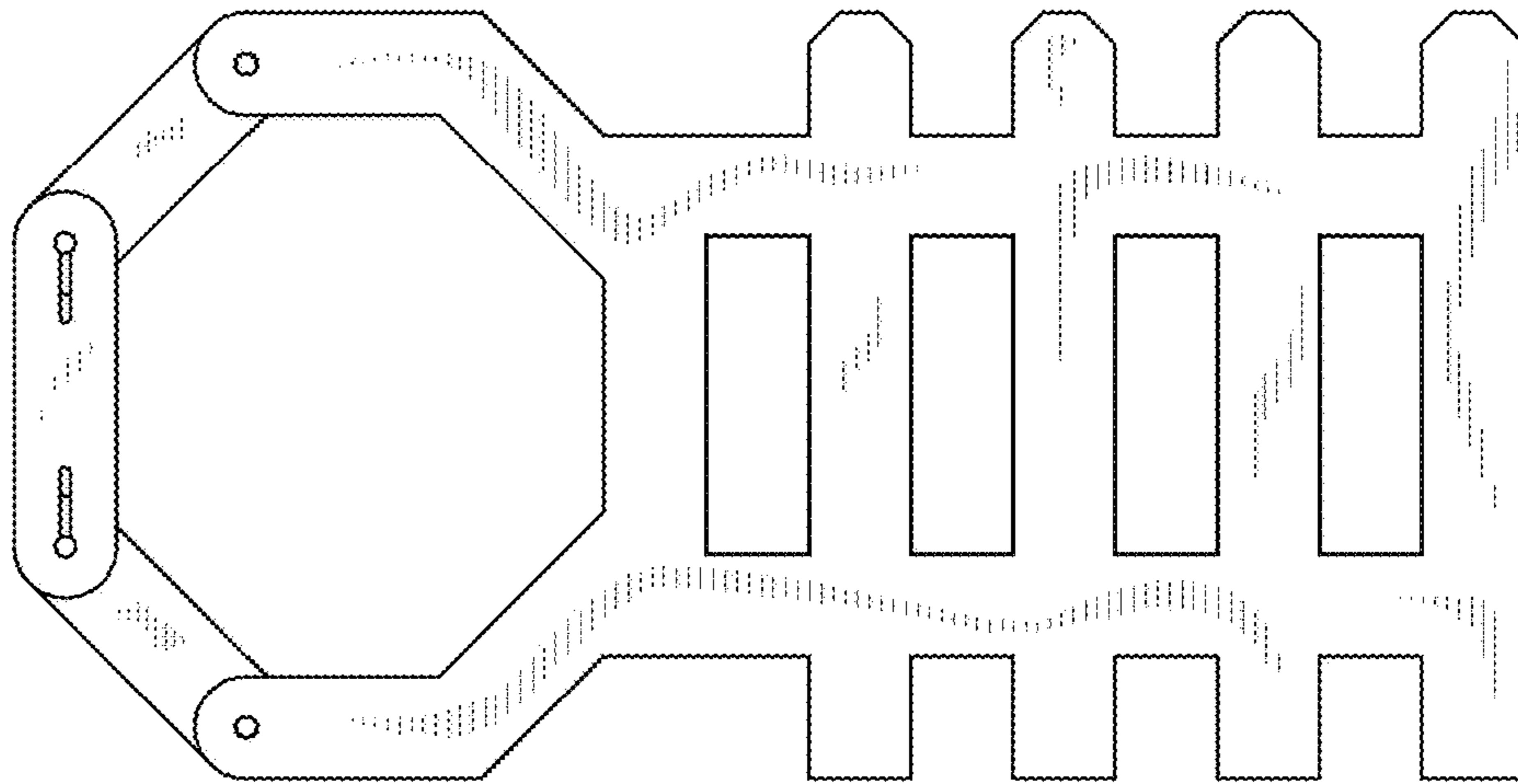

FIG. 2

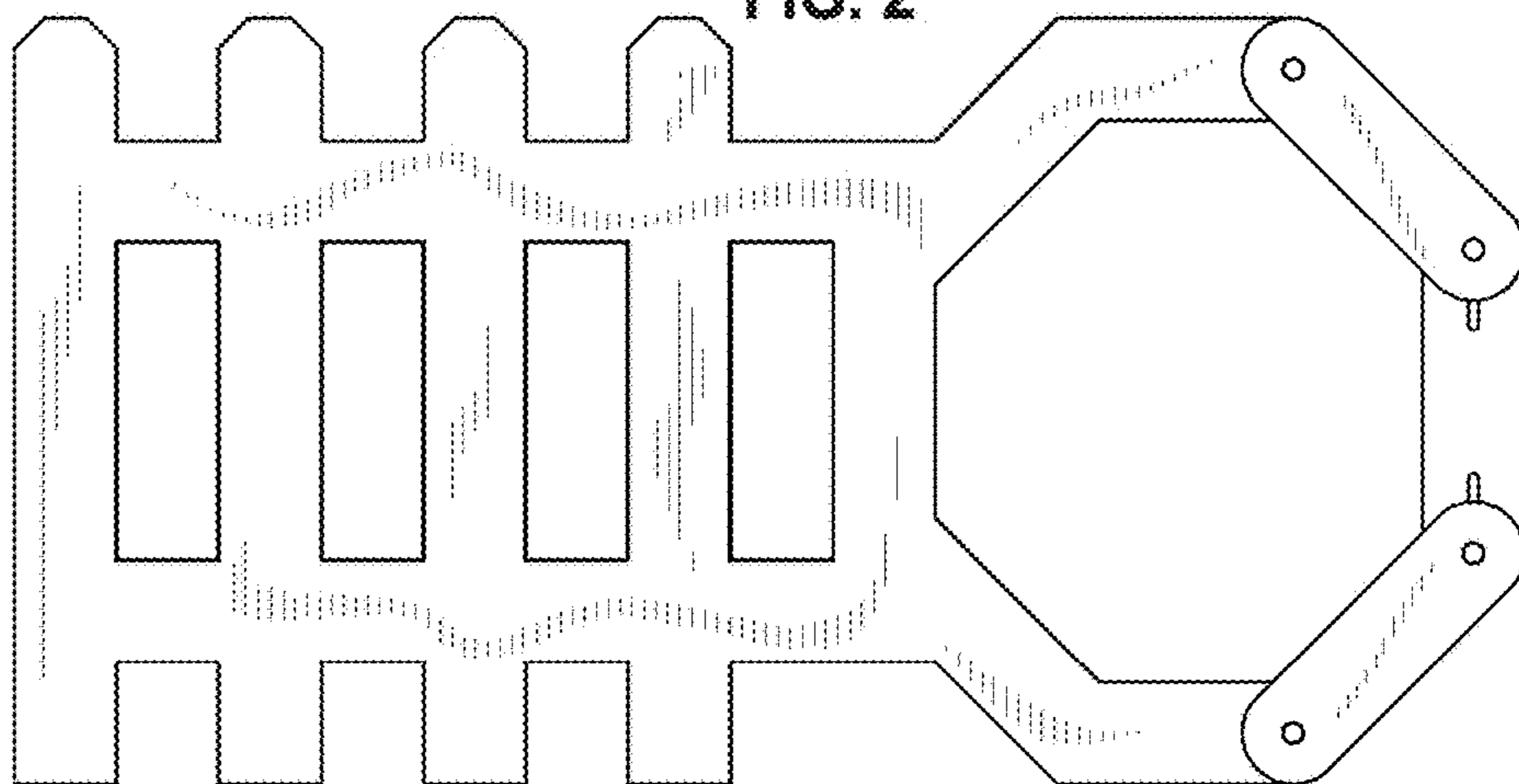

FIG. 3

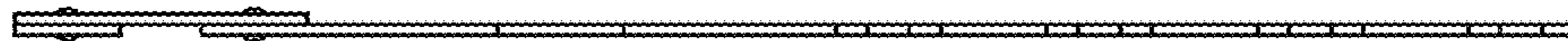

FIG. 4

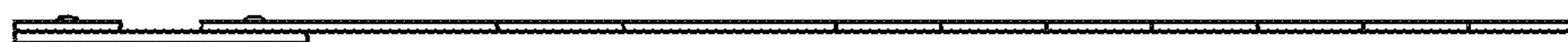

FIG. 5



FIG. 6

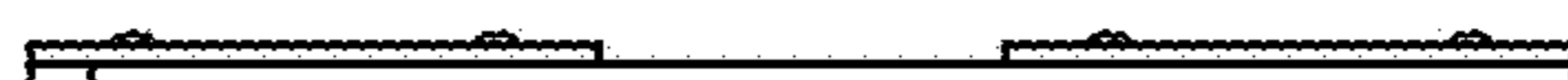

FIG. 7

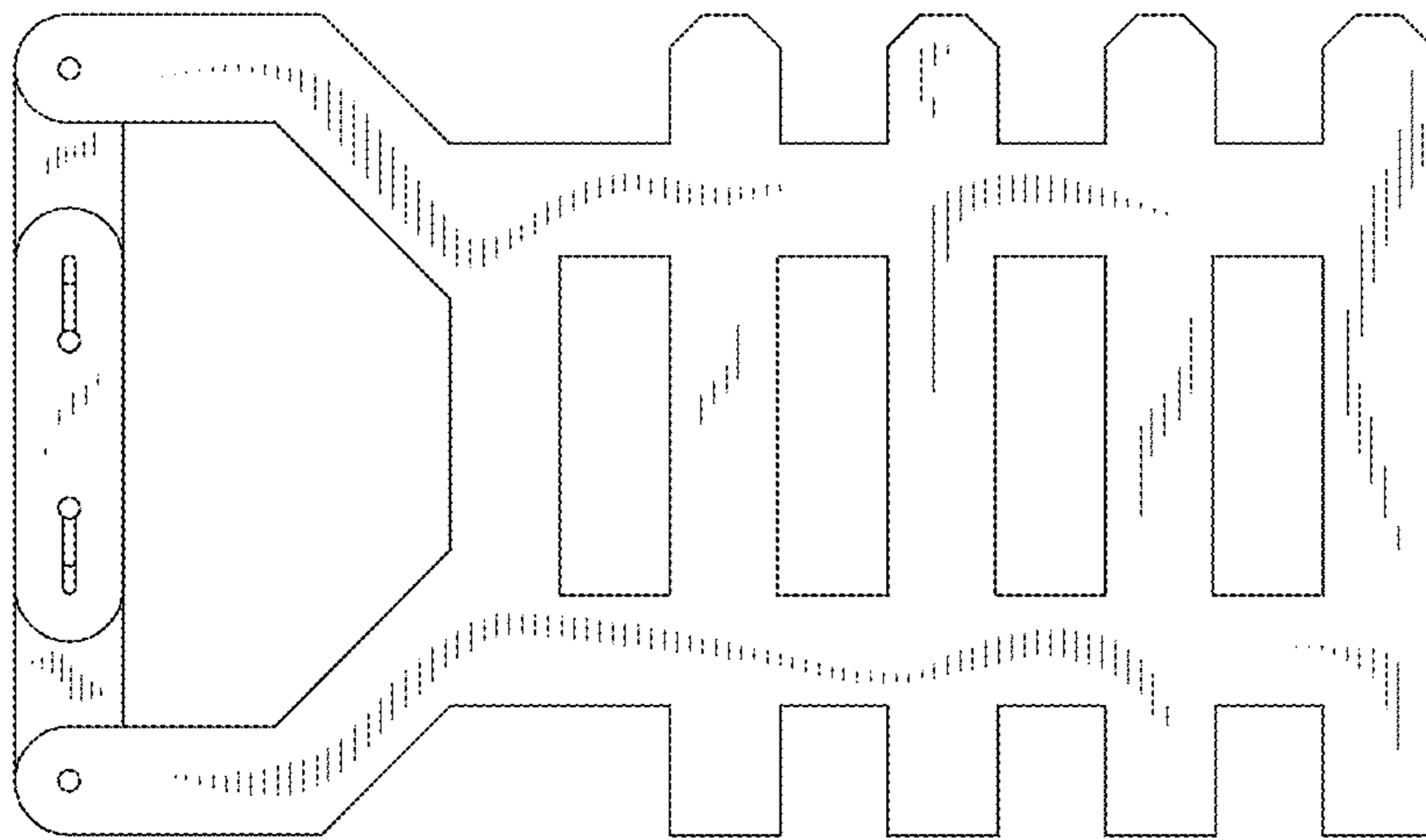

FIG. 8

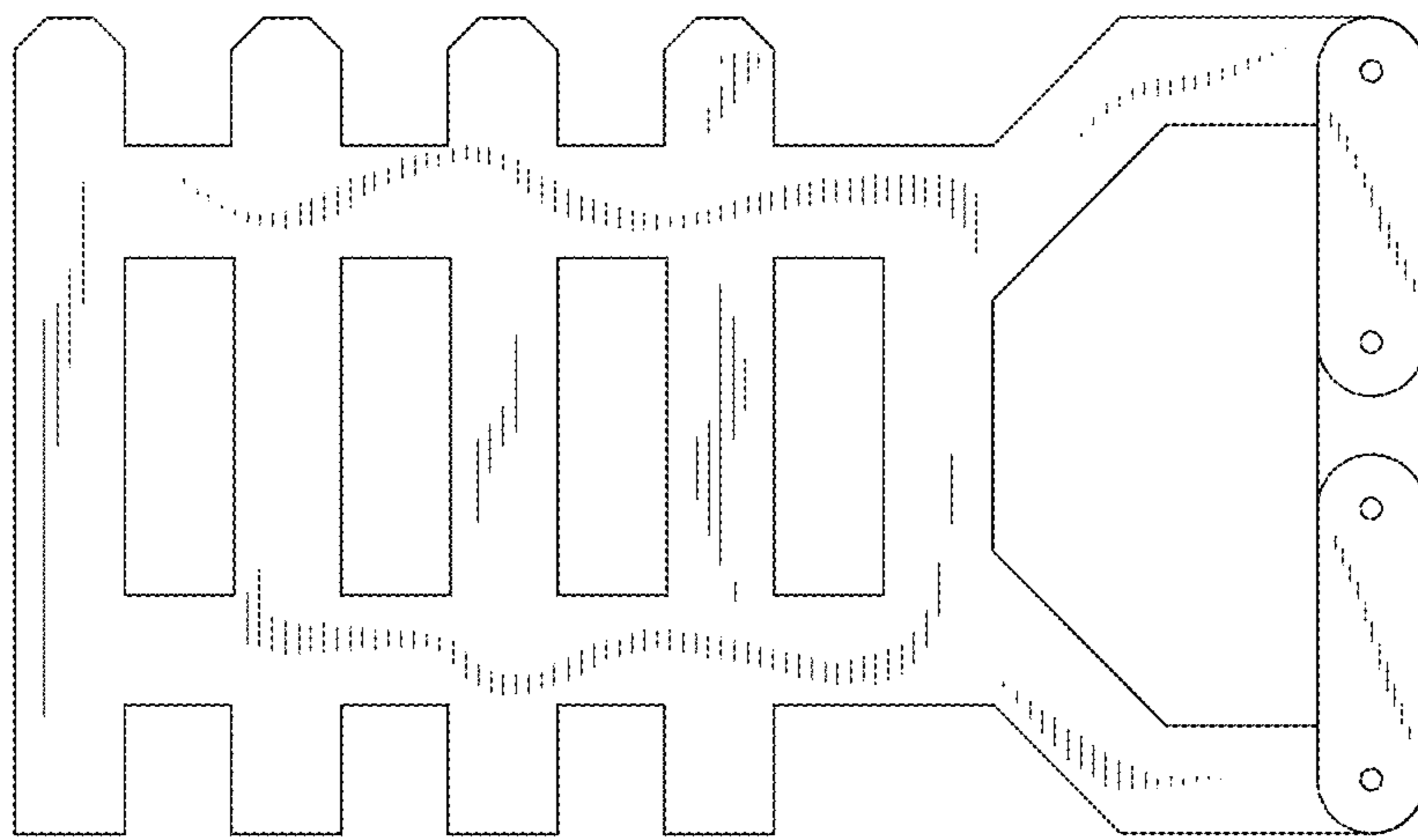

FIG. 9

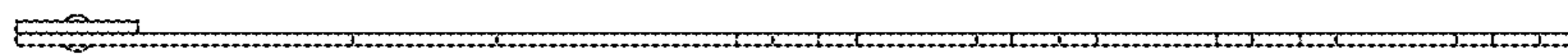

FIG. 10

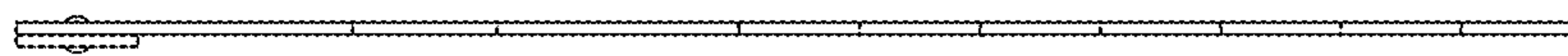

FIG. 11

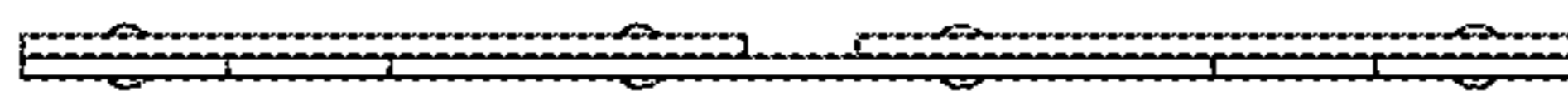

FIG. 12

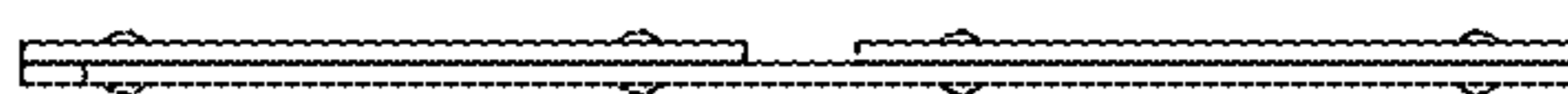

FIG. 13