



US00D832345S

(12) **United States Design Patent**
Walker

(10) **Patent No.:** **US D832,345 S**

(45) **Date of Patent:** **** *Oct. 30, 2018**

(54) **COACHING AID**

(71) Applicant: **Bradley John Walker**, Dural (AU)

(72) Inventor: **Bradley John Walker**, Dural (AU)

(73) Assignee: **BBDK PTY LTD**, Dural (AU), AS TRUSTEE FOR BBDK WALKER FAMILY TRUST

(*) Notice: This patent is subject to a terminal disclaimer.

(**) Term: **15 Years**

(21) Appl. No.: **29/621,519**

(22) Filed: **Oct. 9, 2017**

(51) **LOC (11) Cl.** **19-07**

(52) **U.S. Cl.**
USPC **D19/59**

(58) **Field of Classification Search**

USPC D19/59-64; D21/515, 578; D10/46.1
CPC .. G06N 99/005; A63B 69/00; A63B 69/0002;
A63B 69/345; A63B 71/06; A63F
3/00028; A63F 3/00031; A63F 3/00047;
A63F 3/00533; A63F 7/0608; A63F
7/0612; B43K 23/001; B43K 23/002;
B43L 1/00; B43L 1/008; G09B 1/08;
G09B 19/0038; G09B 19/22; G09F 7/00
See application file for complete search history.

(56) **References Cited**

U.S. PATENT DOCUMENTS

1,042,142 A	10/1912	Pohlig	
1,741,596 A	12/1929	Wright	
2,158,368 A	5/1939	Hurt	
2,355,905 A	8/1944	Bernard	
2,643,466 A *	6/1953	Bucher G09B 1/08 116/222
2,801,476 A	8/1957	Farbeaux	
3,685,170 A	8/1972	Fairleigh	
4,047,308 A	9/1977	Wheeler	

4,186,928 A	2/1980	Hunt
4,378,115 A	3/1983	Terrero
4,452,453 A	6/1984	Daley et al.
4,687,199 A	8/1987	Aguirregomezcorta

(Continued)

OTHER PUBLICATIONS

Kwikgoal. Link: <http://www.kwikgoal.com/product/18P301/Futsal-Magnetic-Dry-Erase-Board>. Visited Aug. 1, 2018. Futsal Magnetic Dry Erase Board. (Year: 2018).*

Primary Examiner — Ian Simmons

Assistant Examiner — Lauren D McVey

(74) *Attorney, Agent, or Firm* — Gorman IP Law, APC

(57) **CLAIM**

The ornamental design for a coaching aid, as shown and described.

DESCRIPTION

FIG. 1 is a perspective view of a first embodiment of a coaching aid, showing my new design;
FIG. 2 is a top plan view thereof;
FIG. 3 is a bottom plan view thereof;
FIG. 4 is a right side elevation view thereof;
FIG. 5 is a left side elevation view thereof;
FIG. 6 is a front elevation view thereof;
FIG. 7 is a rear elevation view thereof;
FIG. 8 is a perspective view of a second embodiment of a coaching aid, showing my new design;
FIG. 9 is a top plan view thereof;
FIG. 10 is a bottom plan view thereof;
FIG. 11 is a right side elevation view thereof;
FIG. 12 is a left side elevation view thereof;
FIG. 13 is a front elevation view thereof; and,
FIG. 14 is a rear elevation view thereof.
The broken lines are included for the purpose of illustrating portions of the coaching aid that form no part of the claimed design.

1 Claim, 8 Drawing Sheets

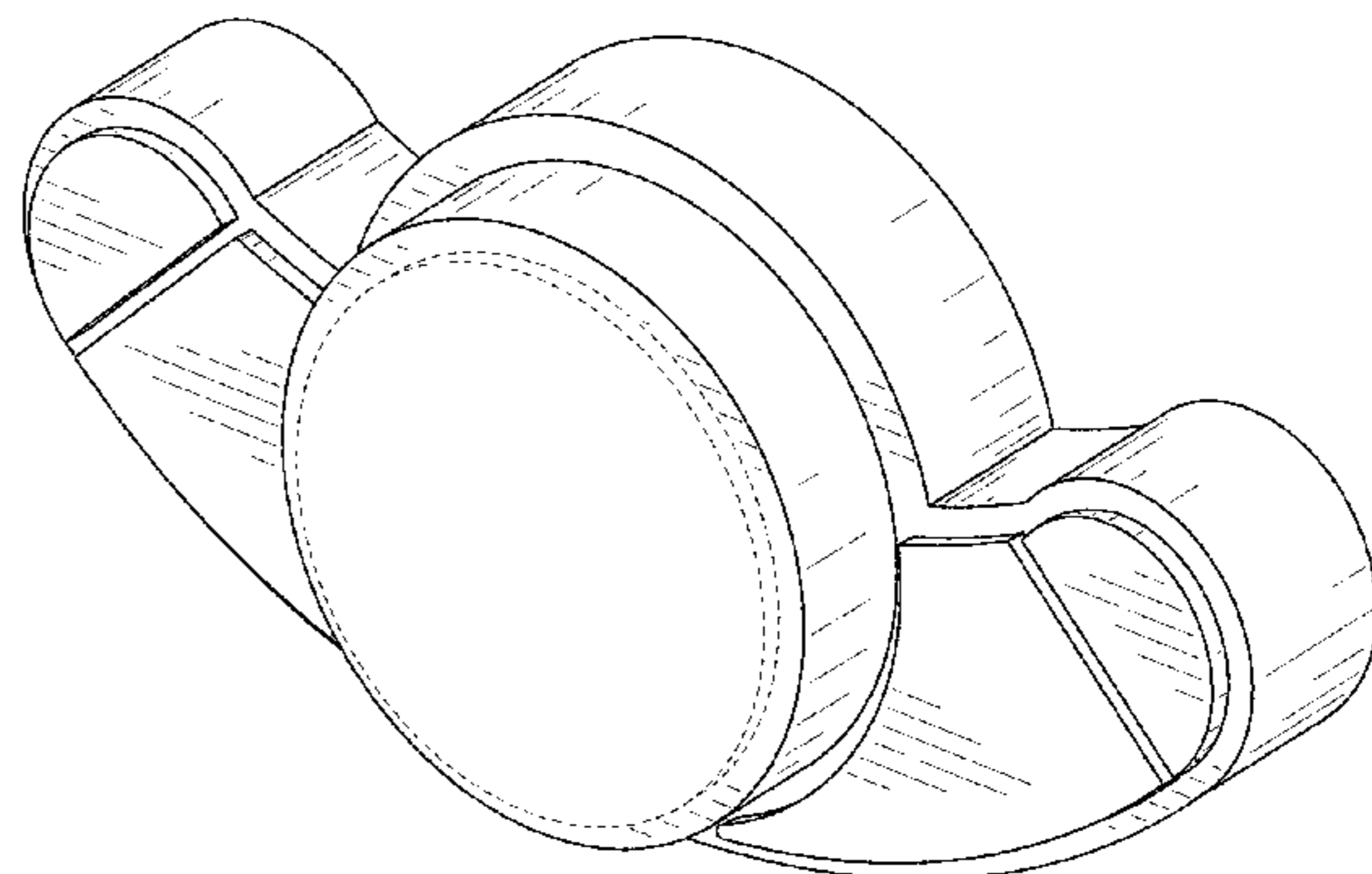
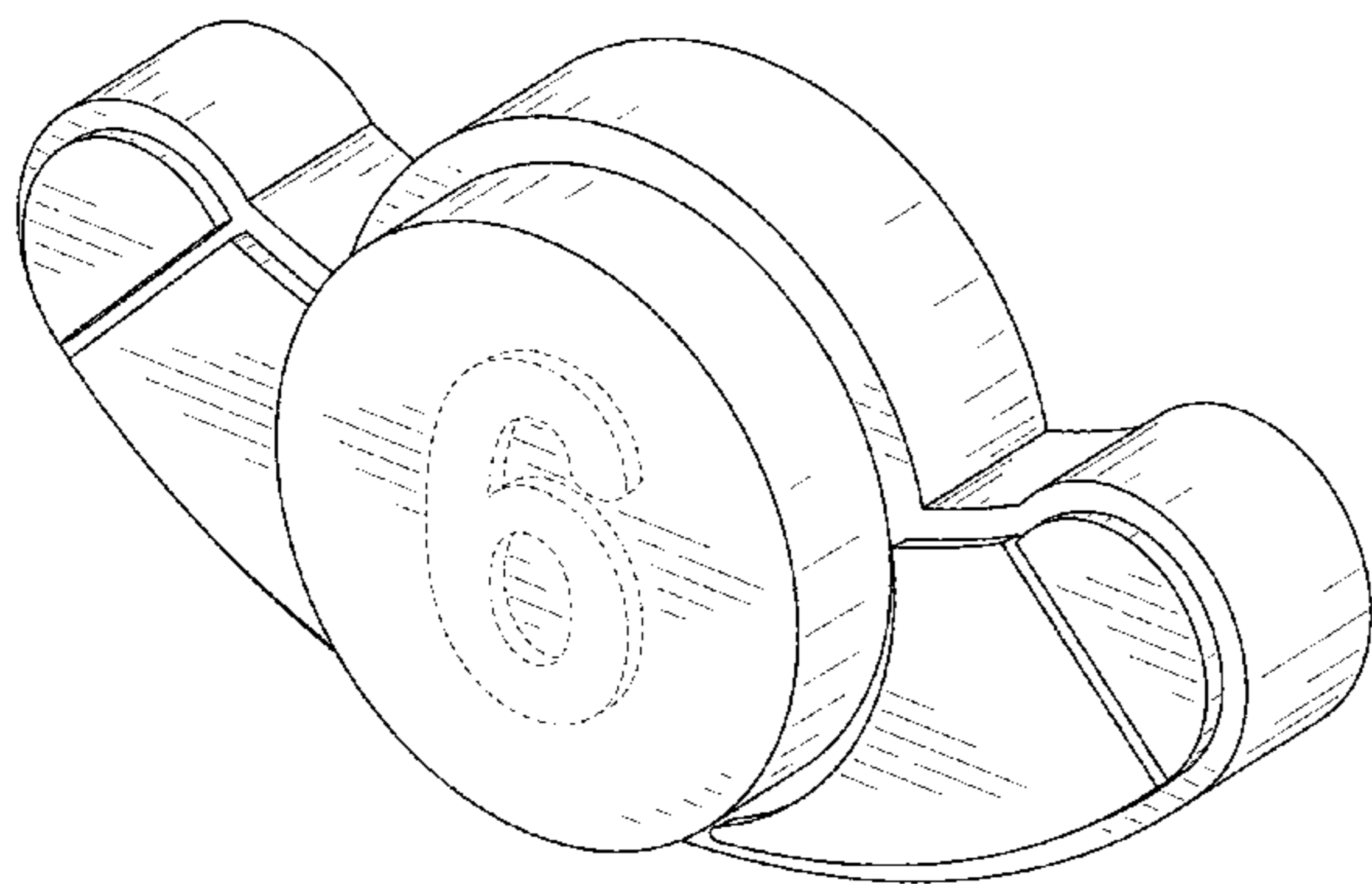

(56)

References Cited

U.S. PATENT DOCUMENTS

D323,629 S * 2/1992 Murphy D10/46.1
5,123,653 A 6/1992 Murphy et al.
5,201,520 A 4/1993 Castle et al.
5,263,866 A 11/1993 Campbell
D358,093 S * 5/1995 Lanteigne D21/385
5,664,780 A 9/1997 Bricker
5,749,581 A 5/1998 Poisson
6,379,156 B1 4/2002 Laravea et al.
6,464,507 B1 10/2002 Bailey
6,530,571 B1 3/2003 McWilliams
D525,662 S 7/2006 Quinn
7,293,771 B1 11/2007 Montgomery
D588,028 S * 3/2009 Cowen D10/46.1
D596,236 S 7/2009 Hackes
8,641,426 B2 2/2014 Yang
D750,707 S * 3/2016 Crawford D19/59
D755,891 S * 5/2016 Chinitz D19/62
D794,130 S * 8/2017 Ralph D21/365
D813,304 S 3/2018 Walker
D823,390 S * 7/2018 Walker D19/59
2007/0099730 A1 5/2007 Driver
2007/0238080 A1 10/2007 Lynch
2010/0279261 A1 11/2010 Gatenby
2012/0157246 A1 * 6/2012 Glover A63B 43/00
473/570
2015/0379899 A1 * 12/2015 Baker G09B 23/285
434/272
2016/0027312 A1 * 1/2016 Kneuper G08G 5/0008
701/120

* cited by examiner

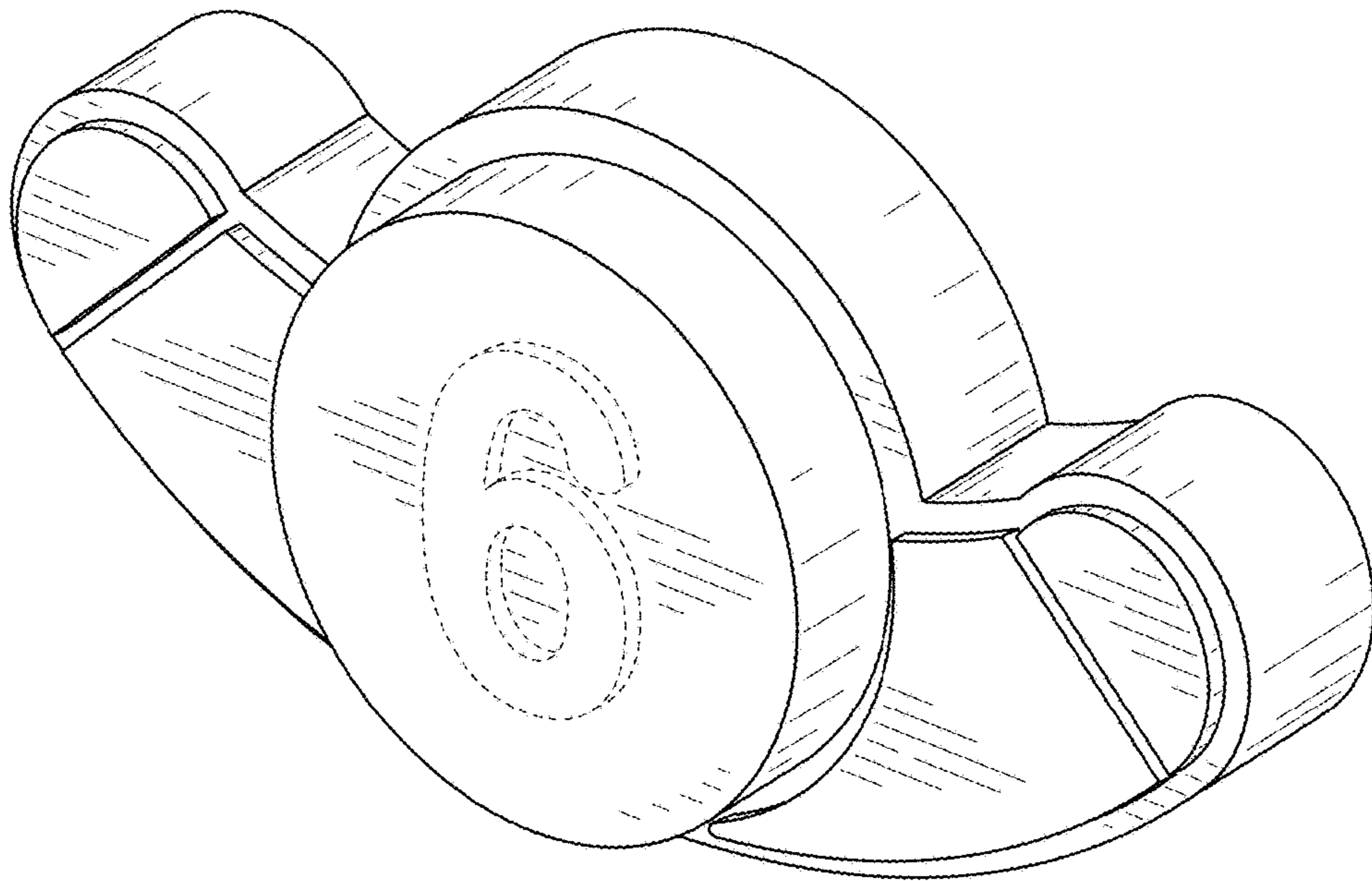

FIG. 1

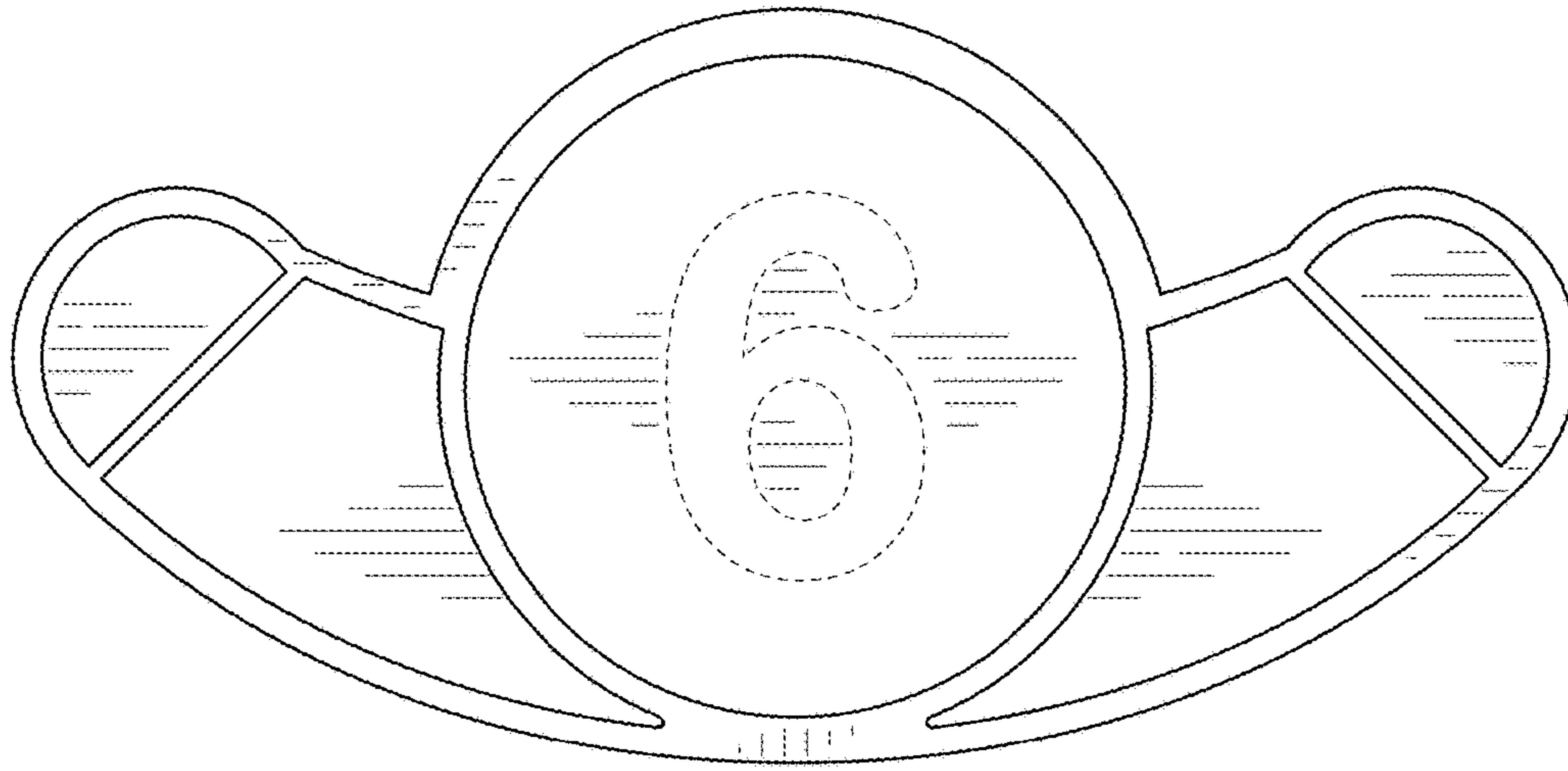

FIG. 2

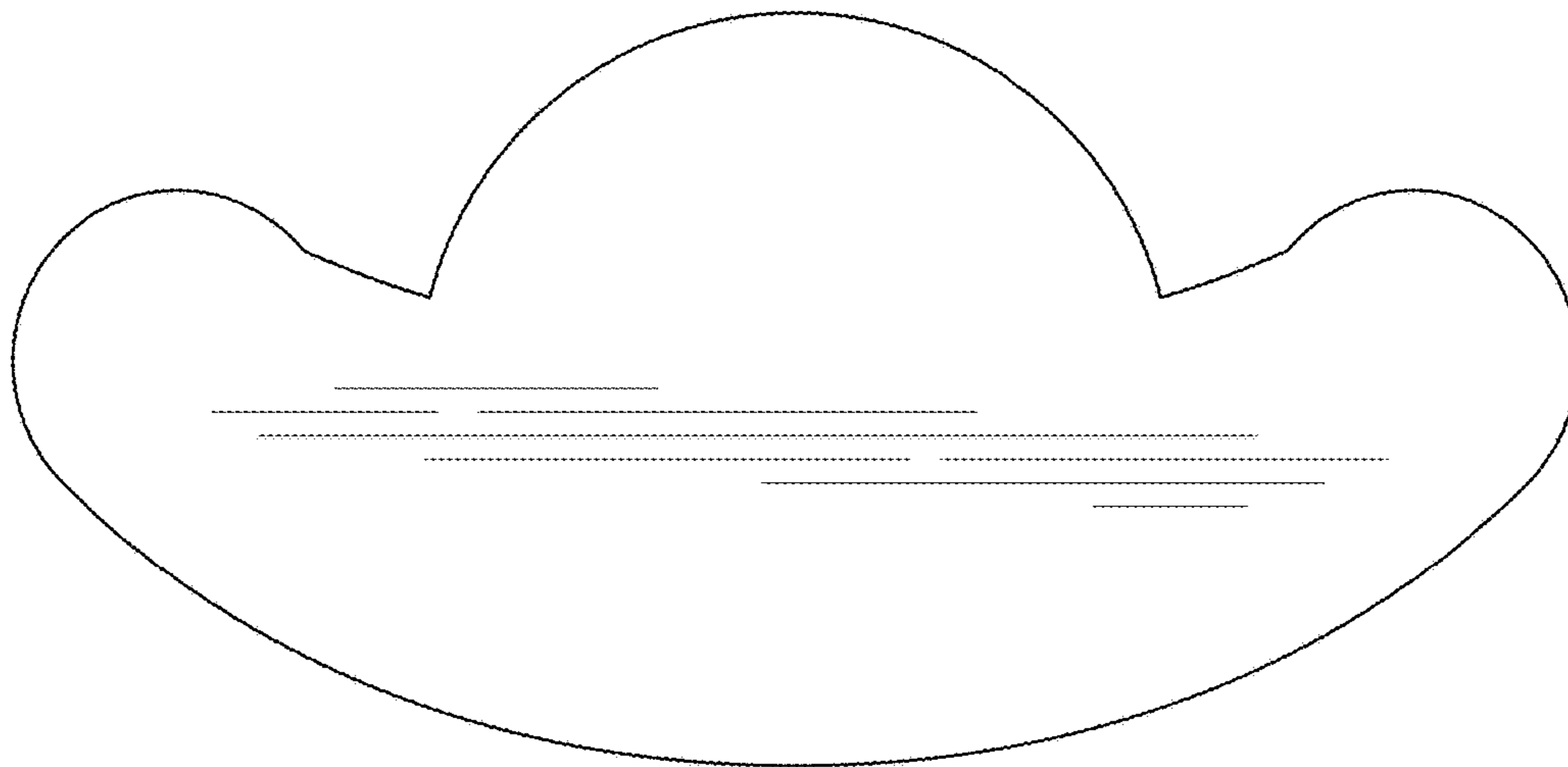

FIG. 3

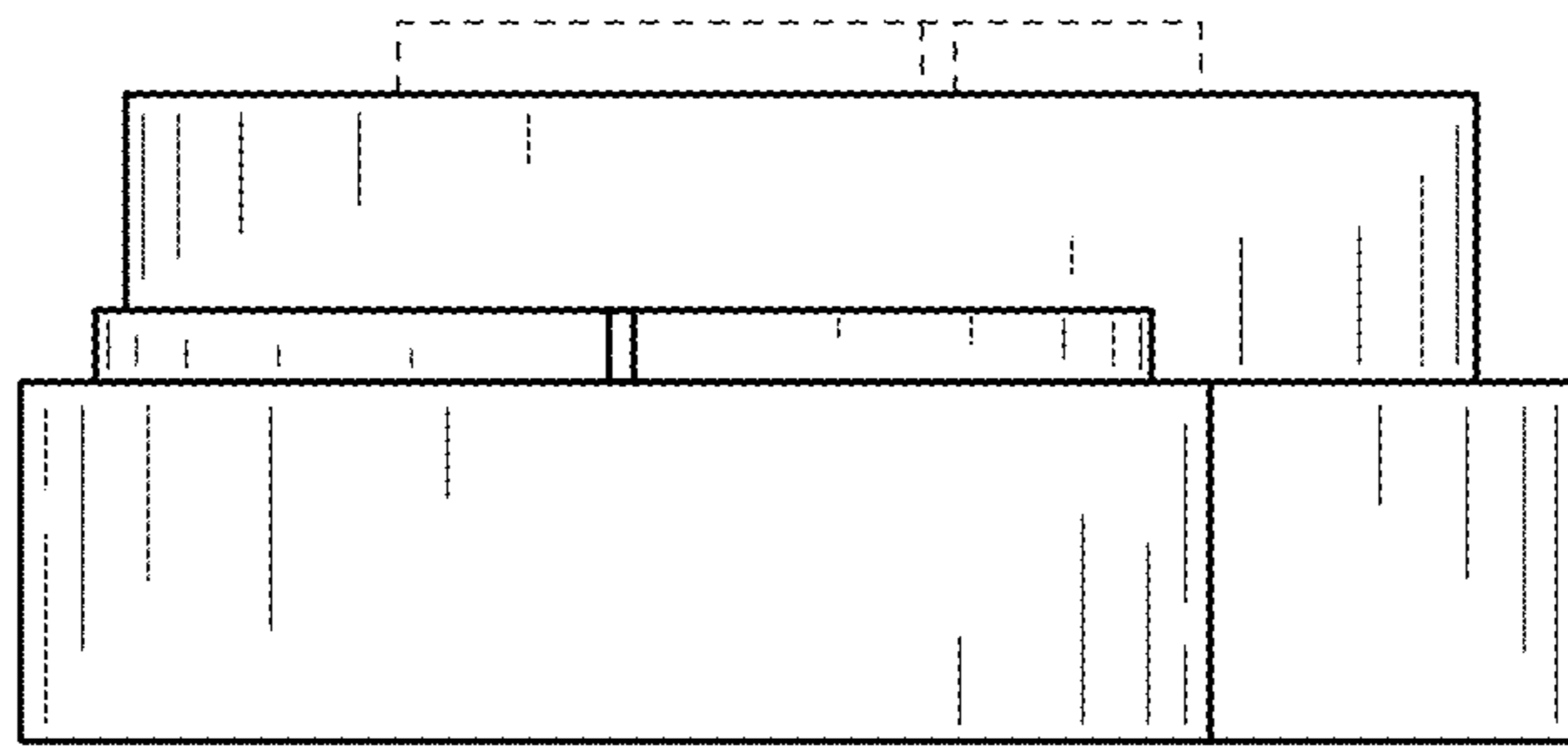

FIG. 4

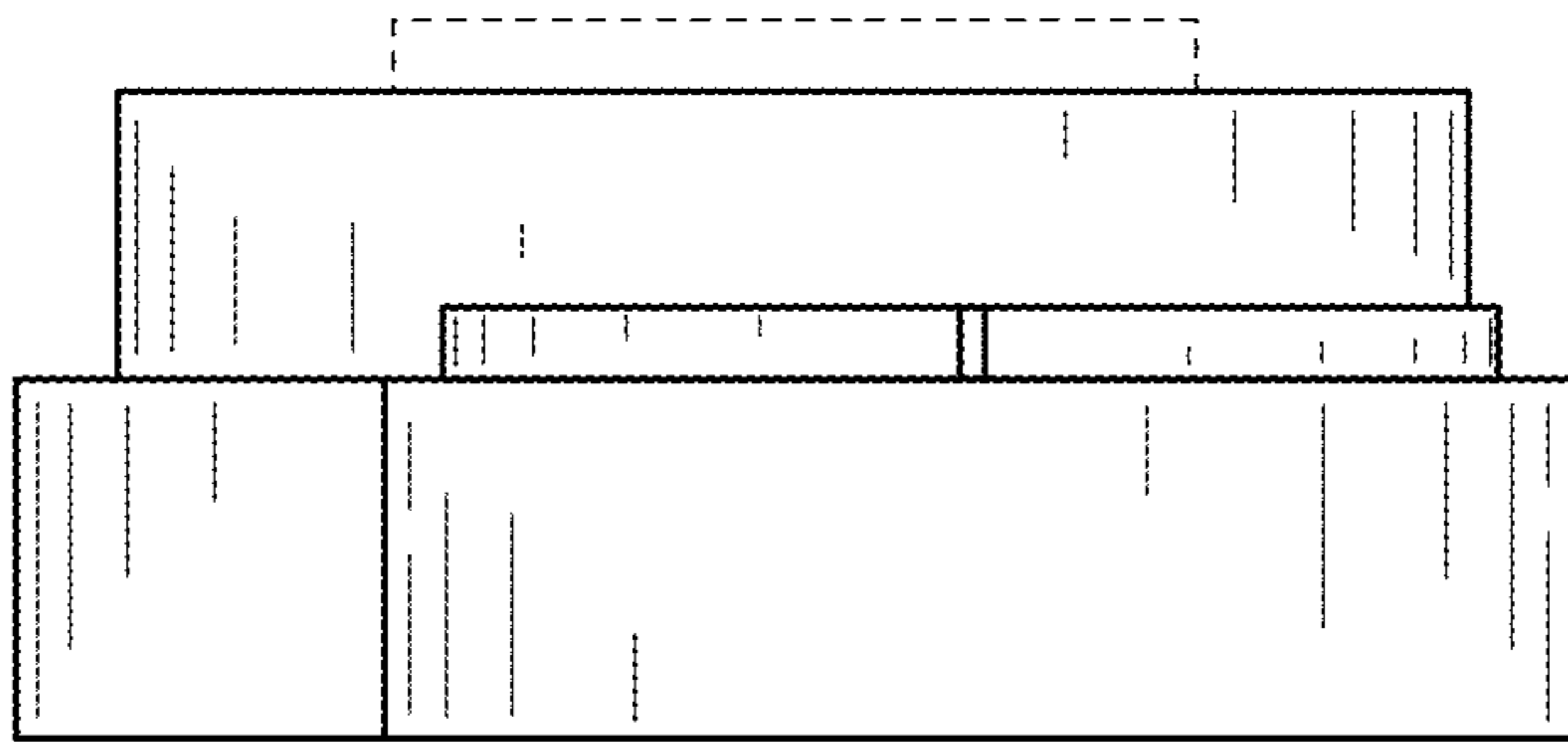

FIG. 5

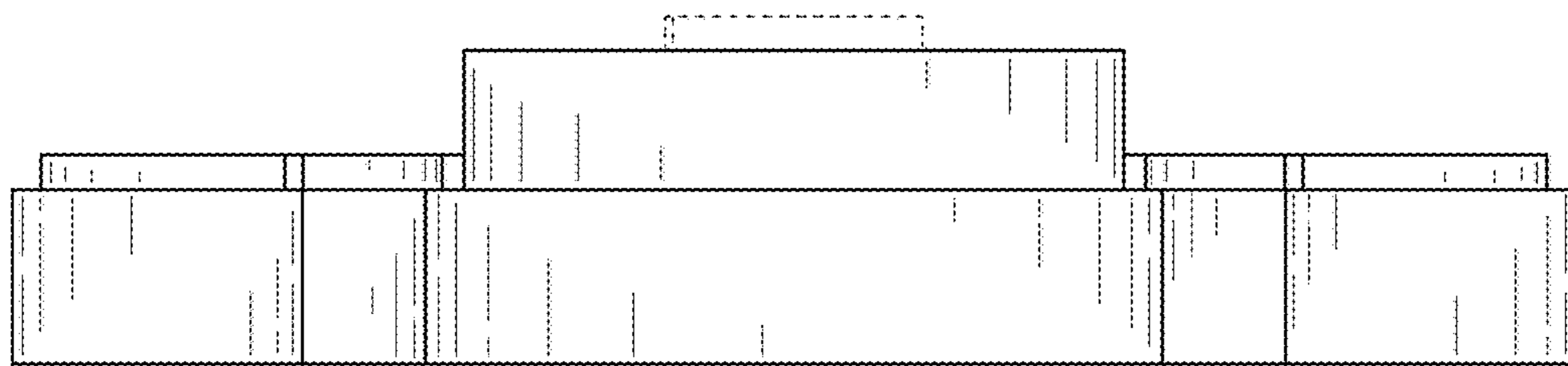

FIG. 6

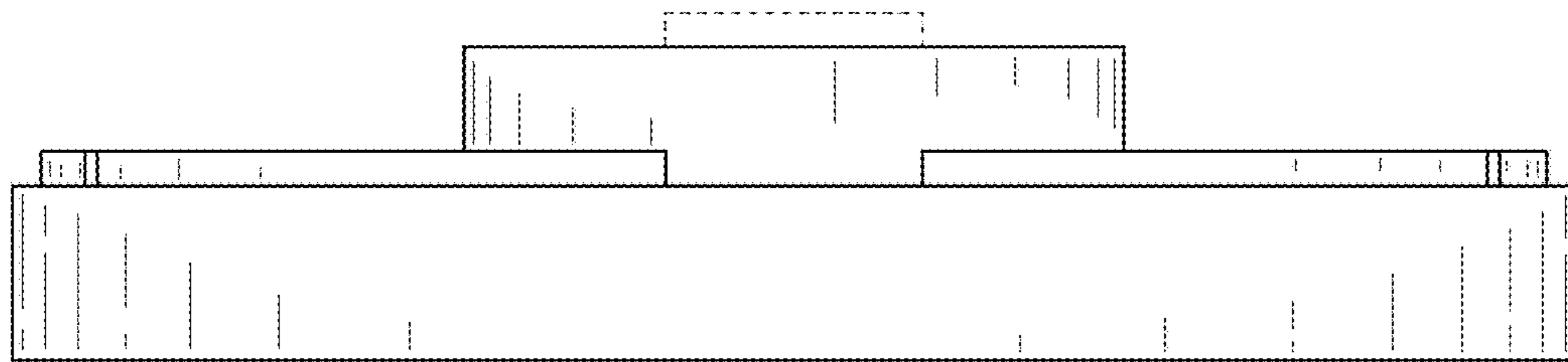

FIG. 7

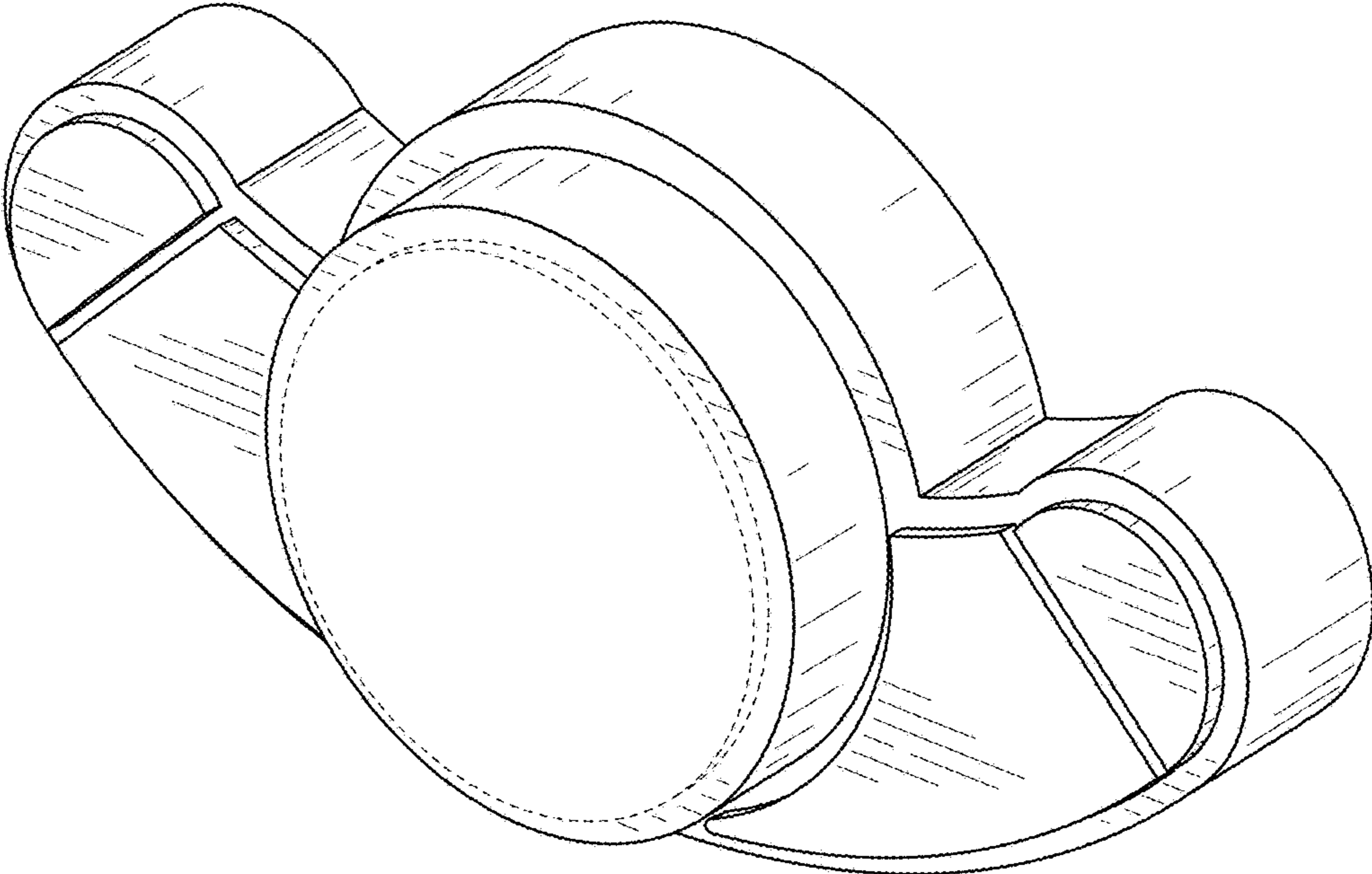

FIG. 8

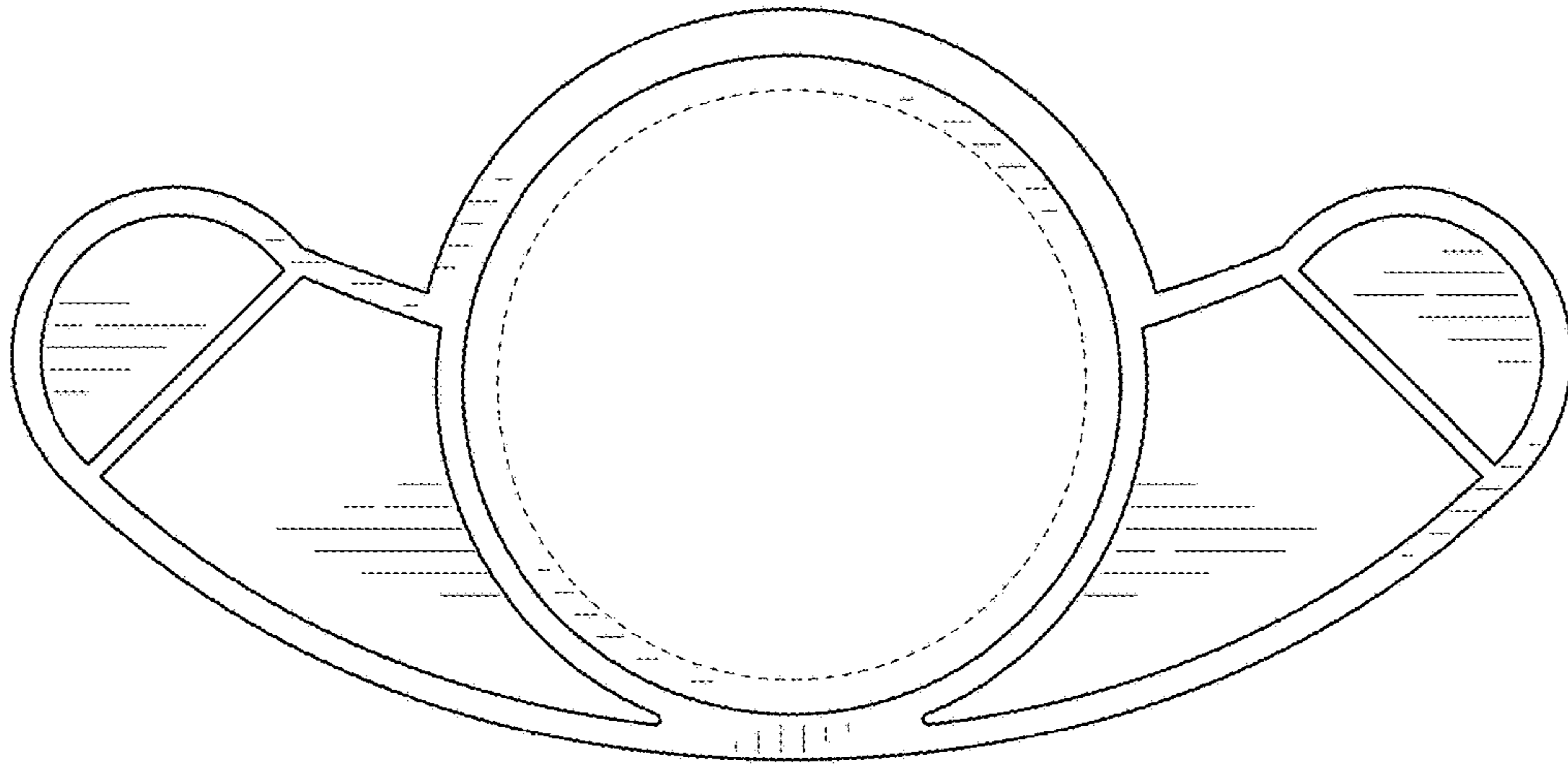

FIG. 9

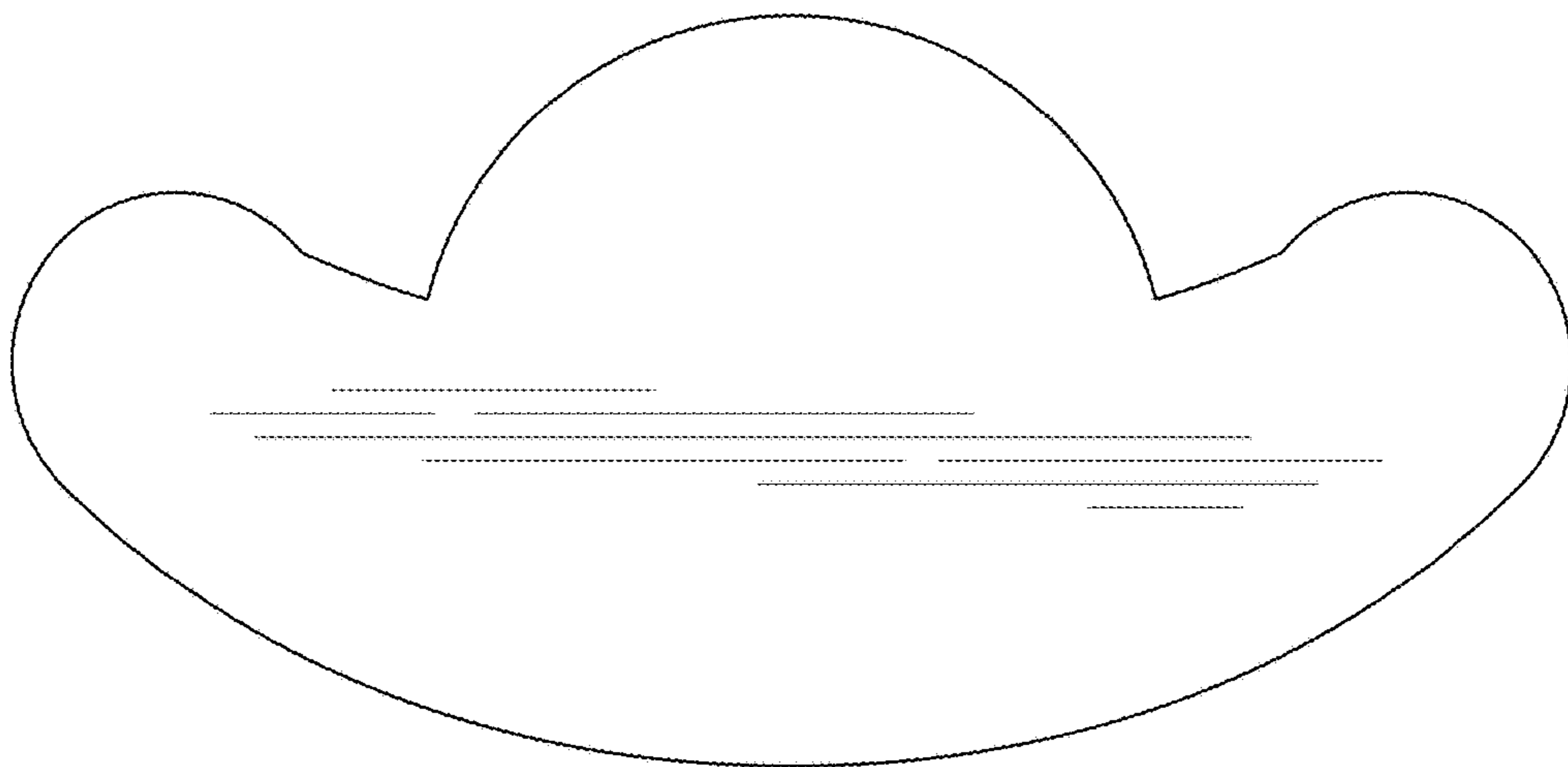

FIG. 10

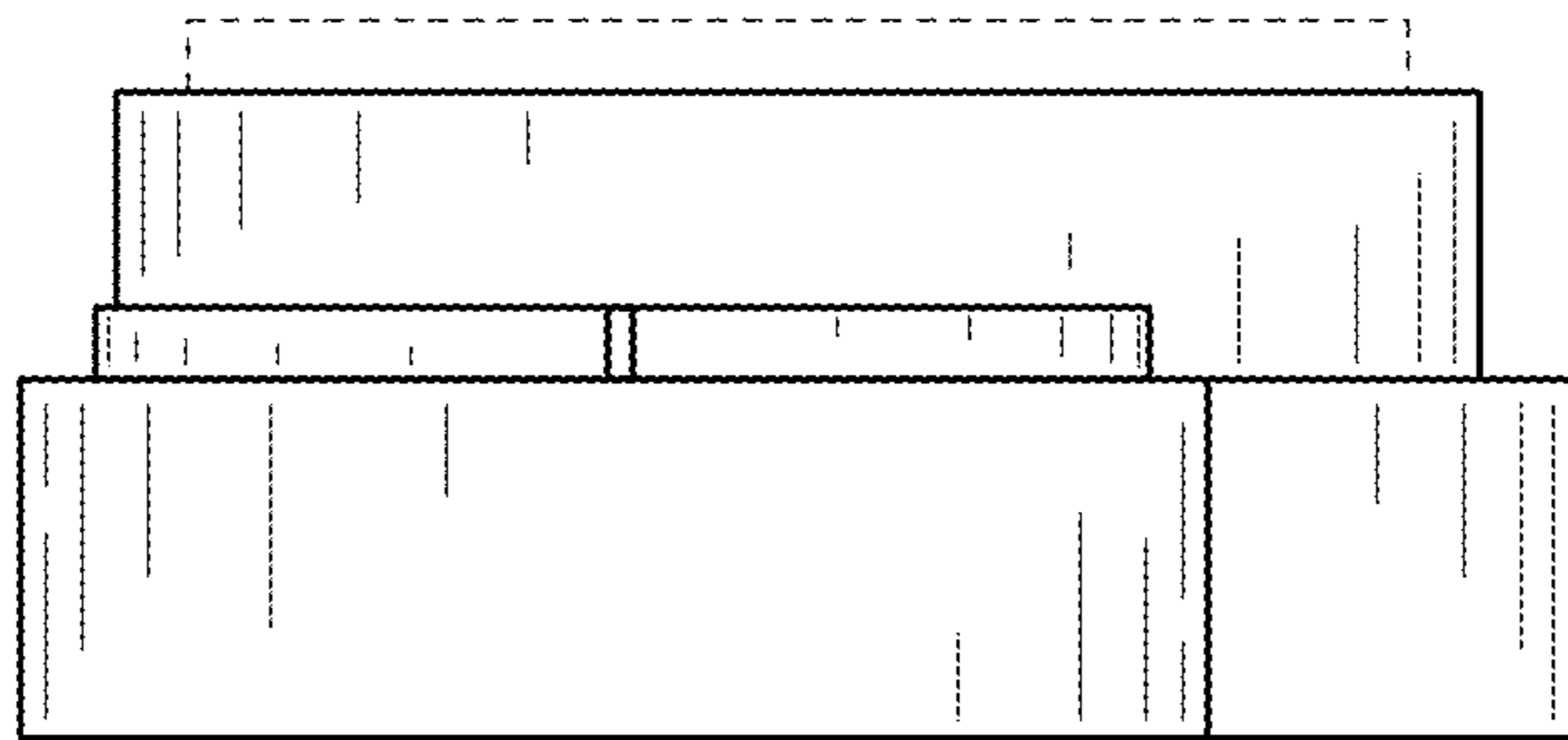

FIG. 11

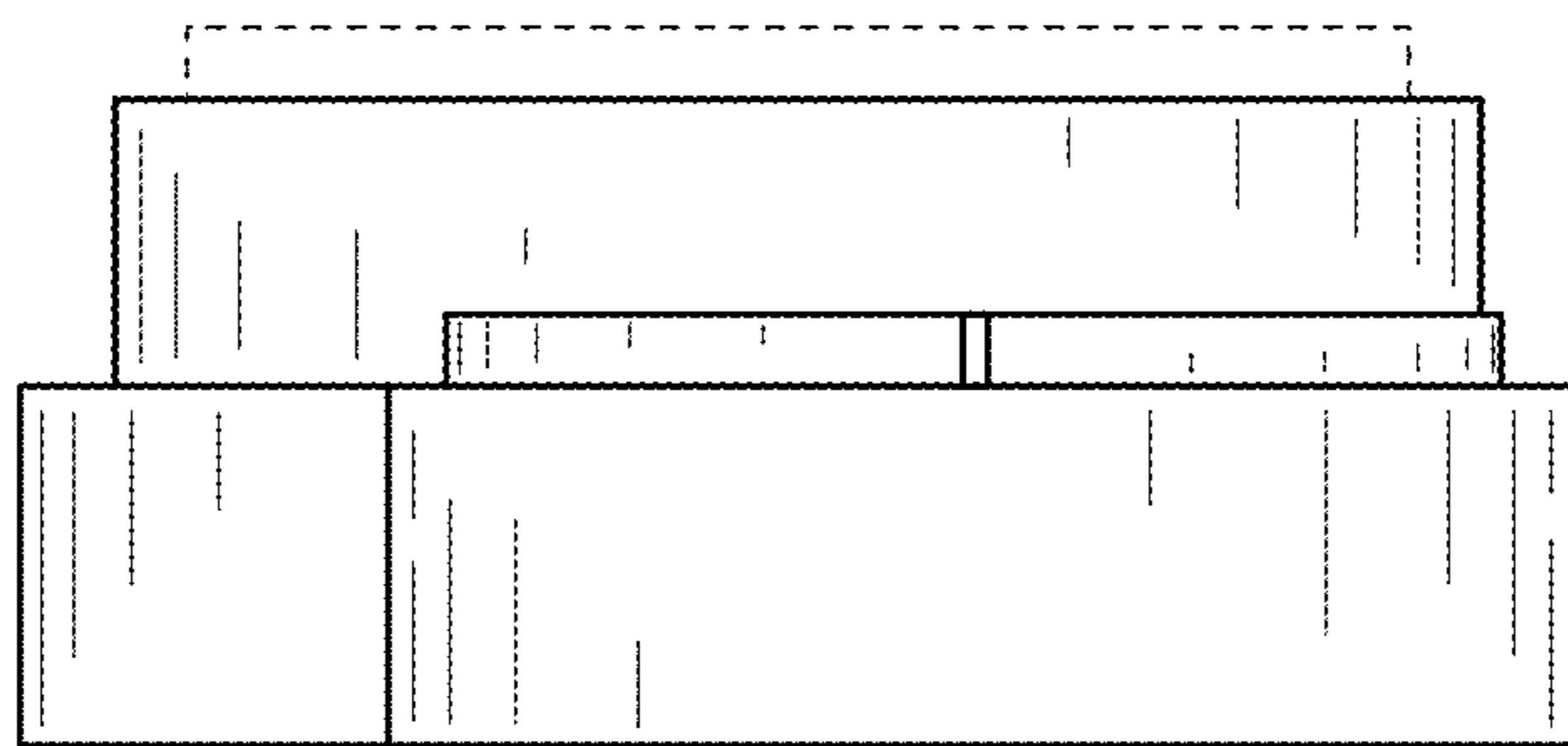

FIG. 12

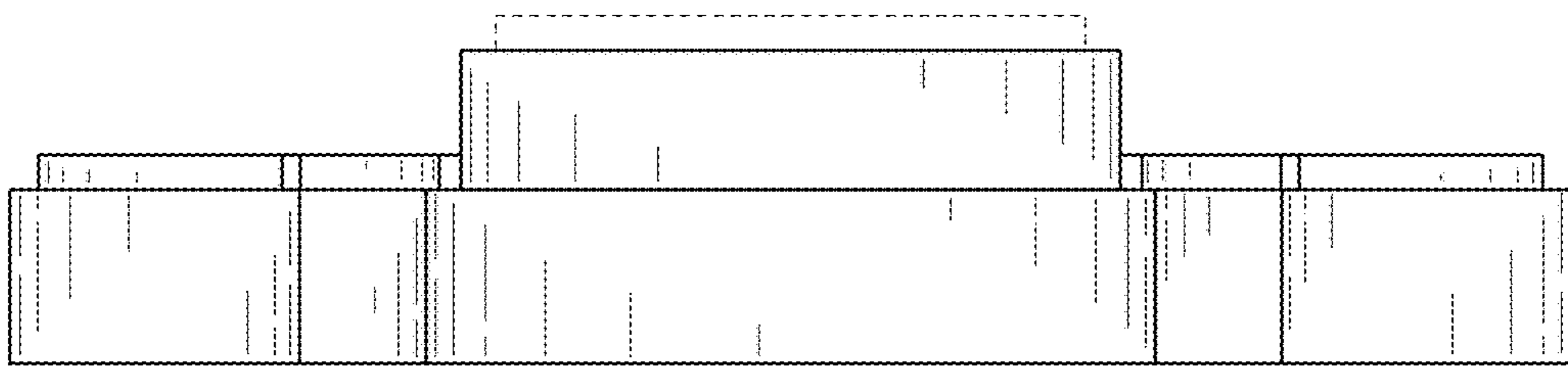

FIG. 13

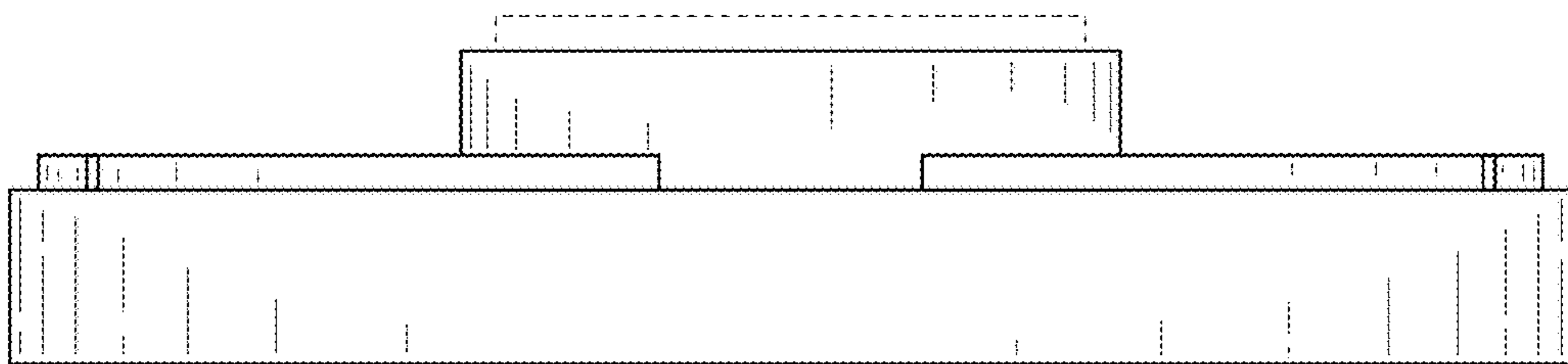

FIG. 14