



US00D832083S

(12) **United States Design Patent** (10) **Patent No.:** **US D832,083 S**
Larsen et al. (45) **Date of Patent:** **** Oct. 30, 2018**

(54) **MOUNTING BRACKET**

(71) Applicant: **TARGET BRANDS, INC.**,
Minneapolis, MN (US)

(72) Inventors: **Selina Larsen**, Minneapolis, MN (US);
David Cheney, New Brighton, MN
(US); **Ryan Lake**, Saint Paul, MN (US)

(**) Term: **15 Years**

(21) Appl. No.: **29/615,812**

(22) Filed: **Aug. 31, 2017**

(51) **LOC (11) Cl.** **08-05**

(52) **U.S. Cl.**
USPC **D8/354**

(58) **Field of Classification Search**
USPC 248/243, 192, 222.13, 225.21; D8/349,
D8/354, 380, 381
CPC A47B 57/42; Y10T 29/49893; Y10T
29/49906
See application file for complete search history.

(56) **References Cited**

U.S. PATENT DOCUMENTS

3,184,200	A	5/1965	McDonnell	
3,697,034	A *	10/1972	Shell	A47B 57/42 211/192
3,759,297	A	9/1973	Anderson et al.	
3,795,379	A	3/1974	Gray	
4,064,996	A	12/1977	Shillum	
4,154,419	A *	5/1979	Breidenbach	A47B 57/402 108/110
4,157,228	A *	6/1979	Hammerschlag	A47B 57/40 211/192
4,324,379	A	4/1982	Ovitz, III	

(Continued)

OTHER PUBLICATIONS

“Penco Clipper Hi Performance Shelf Clips”, printed from www.rsclockers.com/store/The_Warehouse/Shelving_and_Rack/Industrial_

Shelving/Penco_Clipper_Hi_Performance_Shelf_Clip_p231.html, publicly available at least as early as Oct. 20, 2011, per http://web.archive.org (1 page).

(Continued)

Primary Examiner — Lakiya G Rogers
Assistant Examiner — Harold E Blackwell, II

(57) **CLAIM**

The ornamental design for a mounting bracket, as shown and described.

DESCRIPTION

FIG. 1 is a top and rear perspective view of a mounting bracket showing a first embodiment of our new design; FIG. 2 is a front view thereof; FIG. 3 is a rear view thereof; FIG. 4 is a right side view thereof; FIG. 5 is a left side view thereof; FIG. 6 is a top view thereof; and FIG. 7 is a bottom view thereof. FIG. 8 is a top and rear perspective view of a mounting bracket showing a second embodiment of our new design; FIG. 9 is a front view thereof; FIG. 10 is a rear view thereof; FIG. 11 is a right side view thereof; FIG. 12 is a left side view thereof; FIG. 13 is a top view thereof; and FIG. 14 is a bottom view thereof. FIG. 15 is a top and rear perspective view of a mounting bracket showing a third embodiment of our new design; FIG. 16 is a front view thereof; FIG. 17 is a rear view thereof; FIG. 18 is a right side view thereof; FIG. 19 is a left side view thereof; FIG. 20 is a top view thereof; and FIG. 21 is a bottom view thereof. In the drawings, the broken lines depict unclaimed holes through the mounting bracket and form no part of the claimed design.

1 Claim, 6 Drawing Sheets

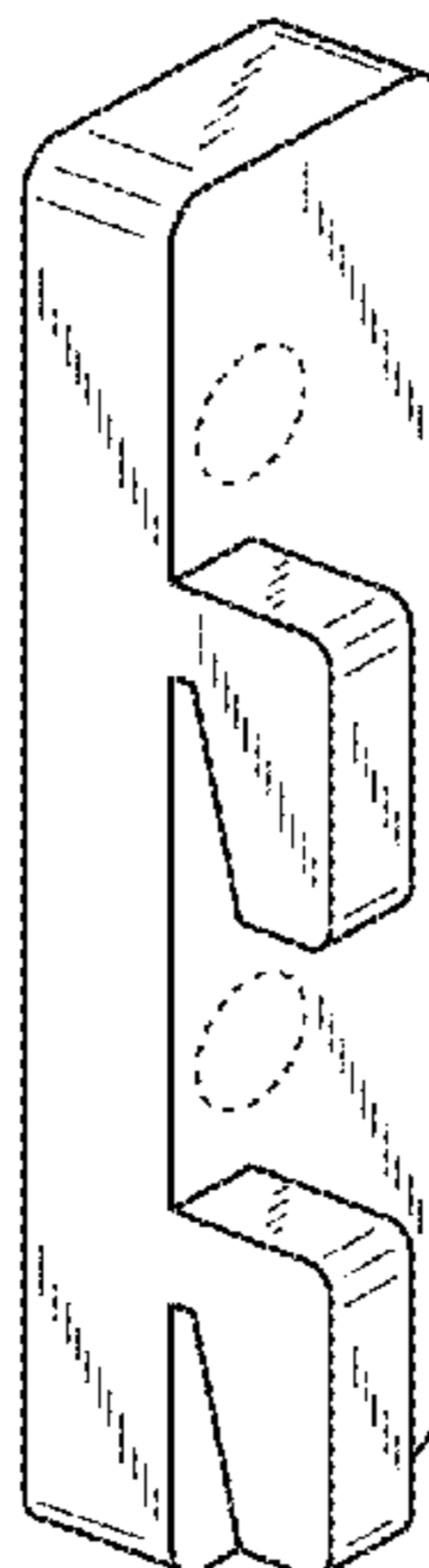

(56)

References Cited

U.S. PATENT DOCUMENTS

4,405,110	A	9/1983	Gibbons	
4,917,337	A	4/1990	Gridley	
D312,959	S	12/1990	Hamann	
5,348,385	A	9/1994	Berg	
5,356,106	A	10/1994	Trotta et al.	
5,575,444	A	11/1996	Otema	
6,019,328	A	2/2000	Allen	
D495,588	S *	9/2004	Wurdack	D8/367
D505,615	S	5/2005	Shea	
D550,540	S	9/2007	Nawrocki	
7,575,212	B1 *	8/2009	Langelius	A47B 57/42 211/192
D615,847	S	5/2010	Tezak et al.	
D651,503	S *	1/2012	Ellis	D8/349
D674,682	S	1/2013	Shea	
8,979,414	B2	3/2015	Talamantes et al.	
9,526,357	B2 *	12/2016	Howard	A47F 5/0807

OTHER PUBLICATIONS

“Turbo Air Keyhold Shelf Clip”, printed from www.etundra.com/restaurant-parts/refrigeration-parts/shelf-har...are/turbo-air-3022010900-keyhole-shelf-clip-for-one-half-inch-centers/, publicly available at least as early as Jun. 16, 2017 (3 pages).

* cited by examiner

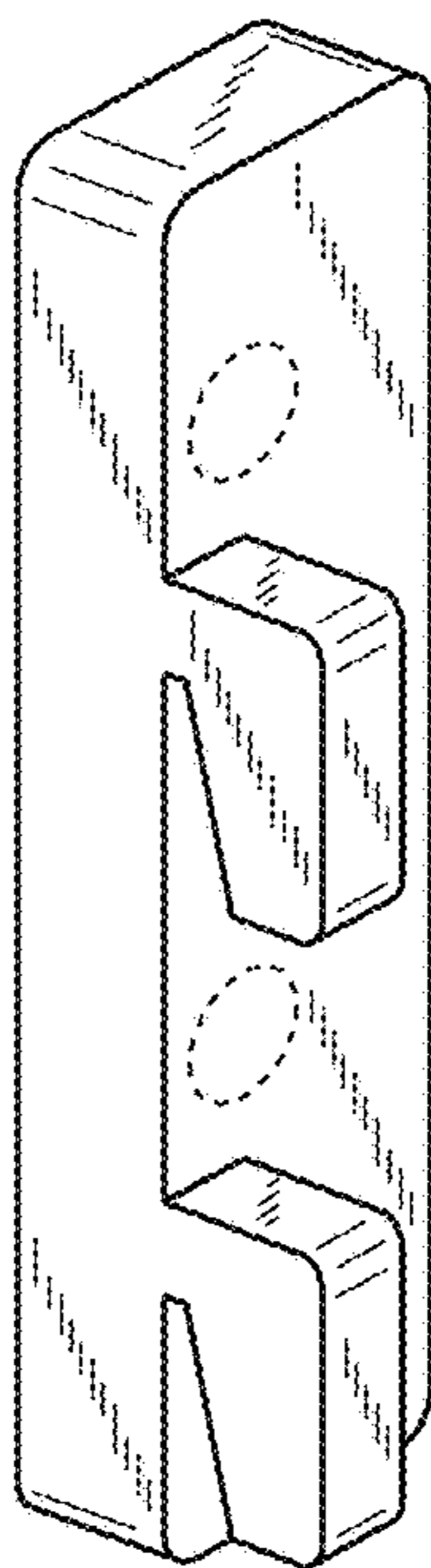

FIG. 1

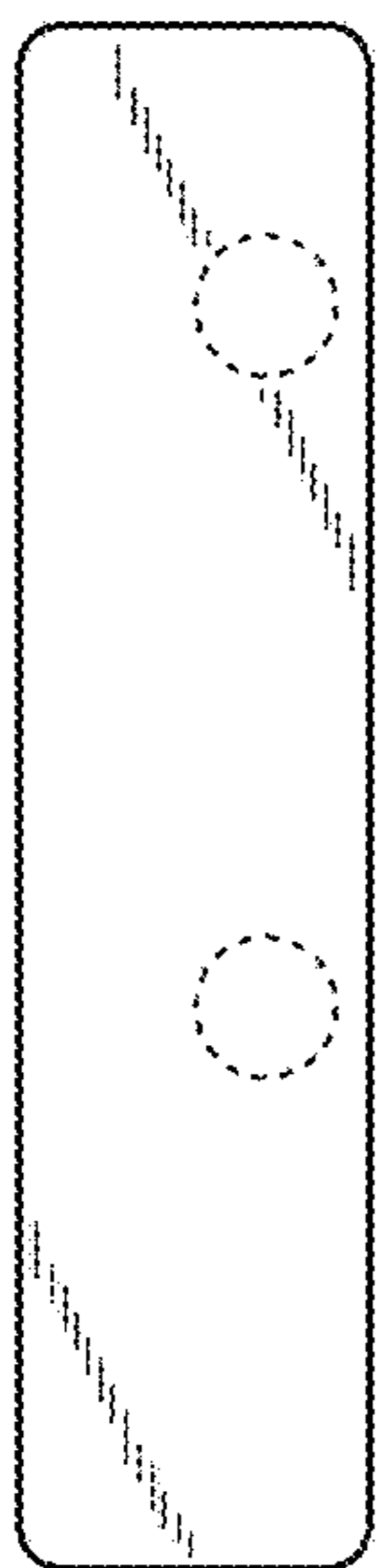

FIG. 2



FIG. 3

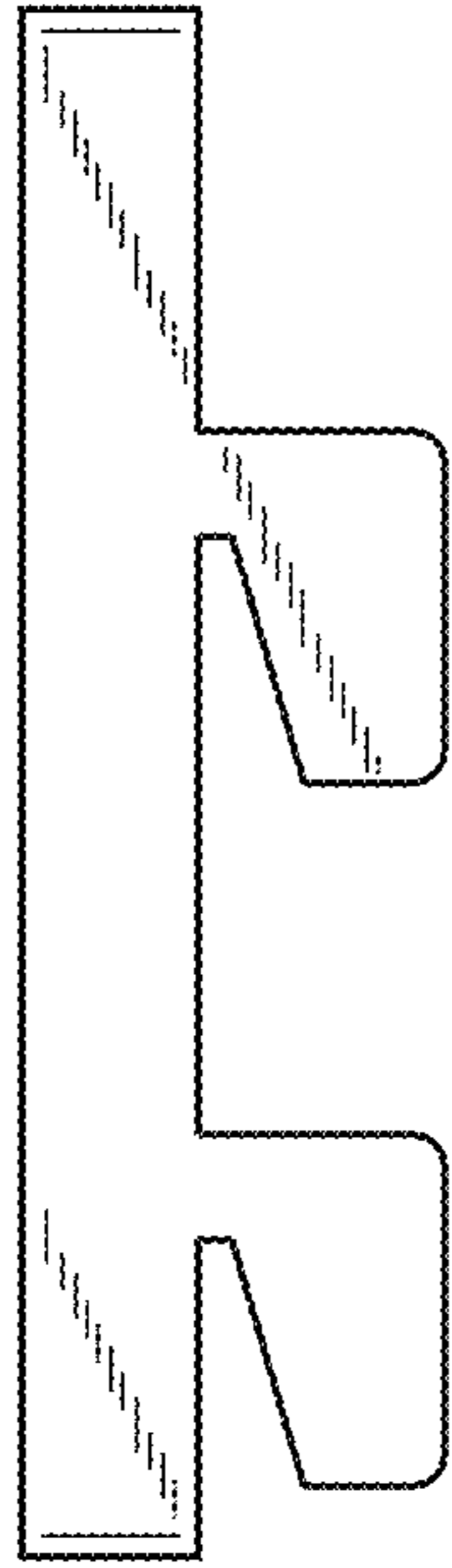

FIG. 4

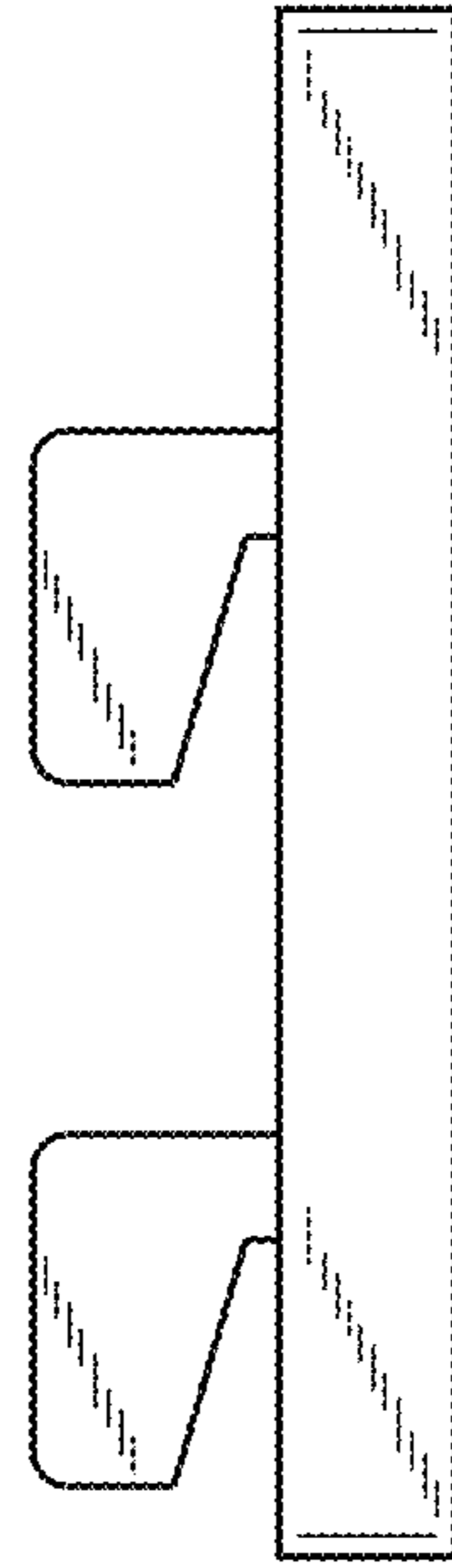

FIG. 5

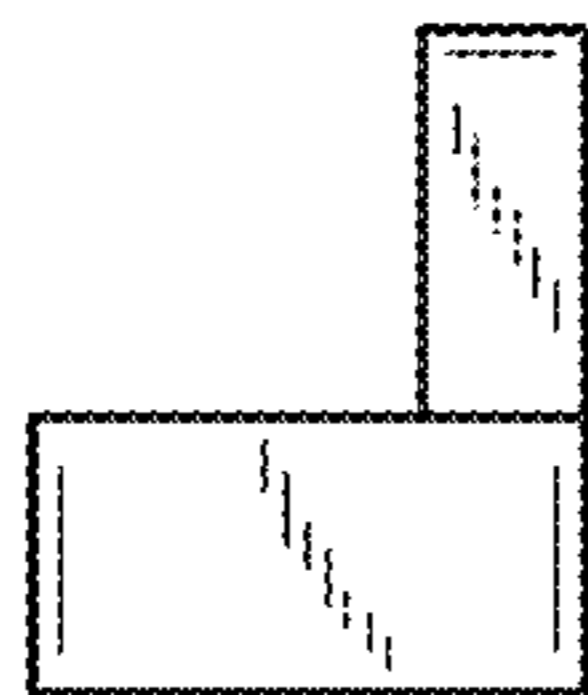

FIG. 6

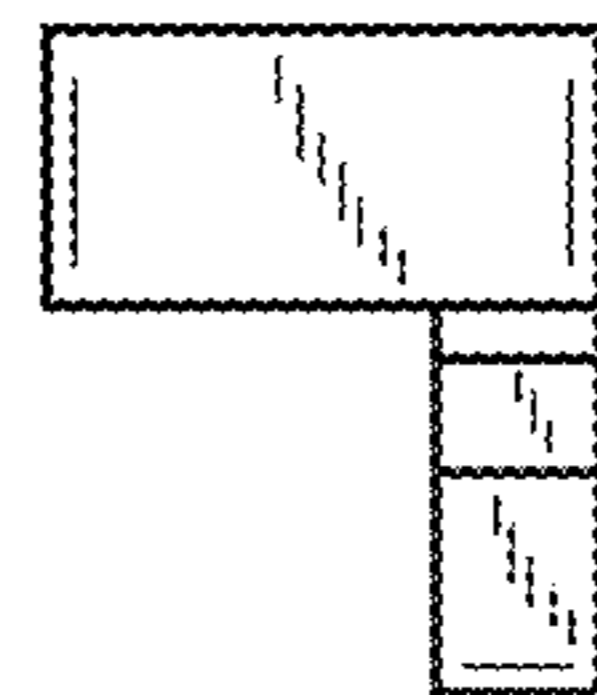

FIG. 7

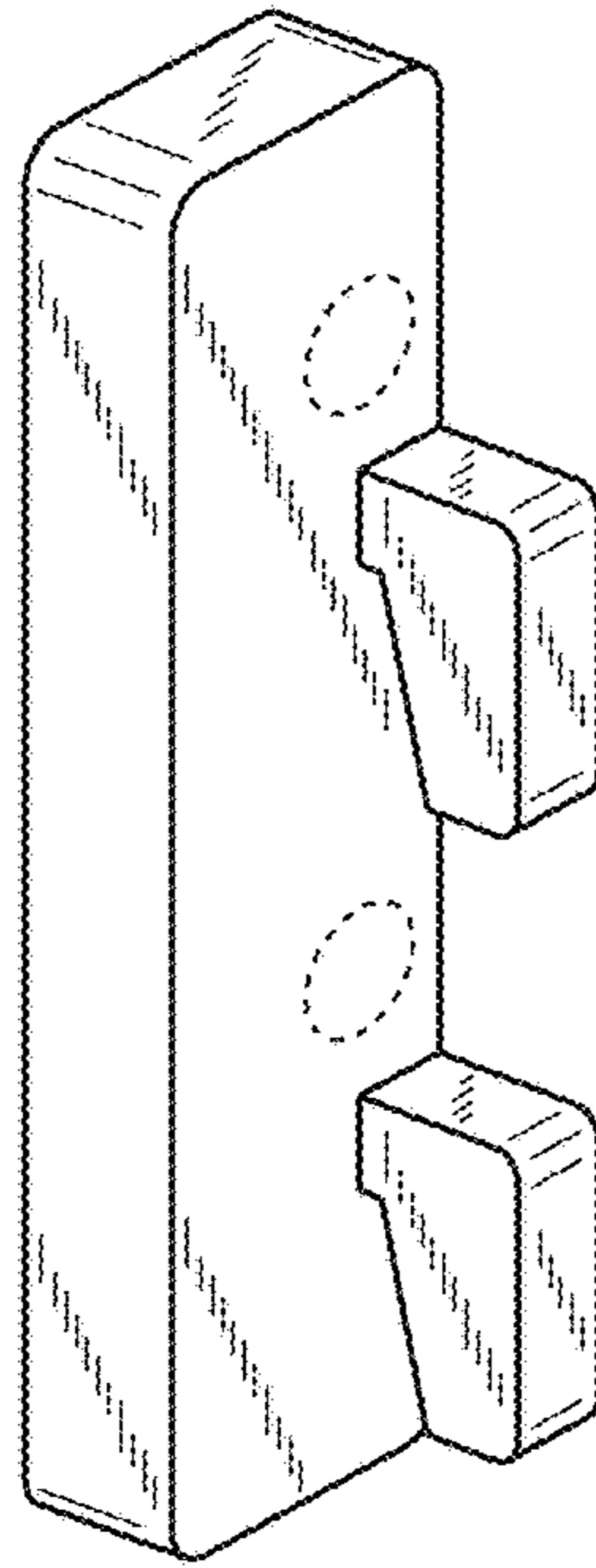

FIG. 8

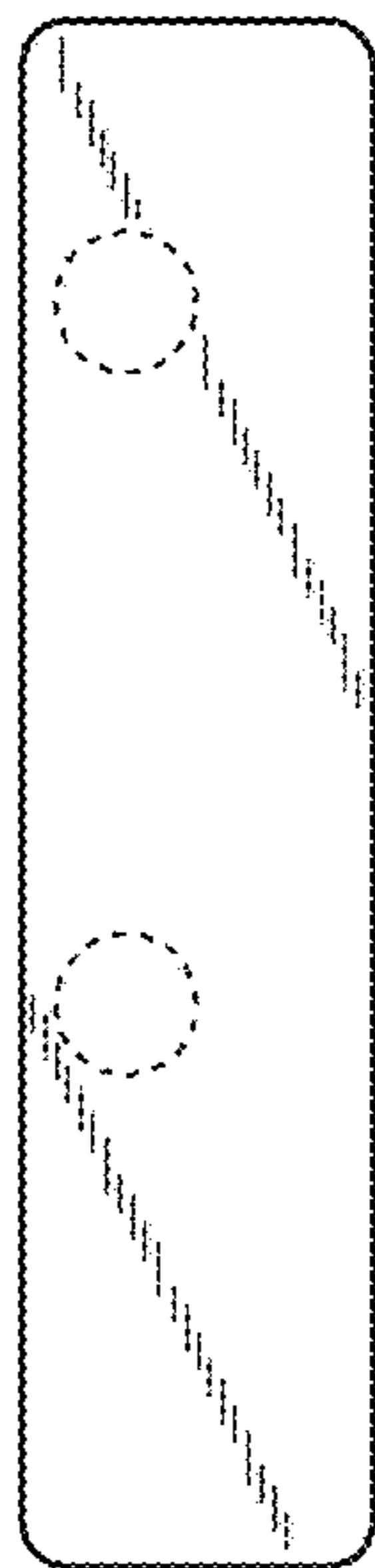

FIG. 9

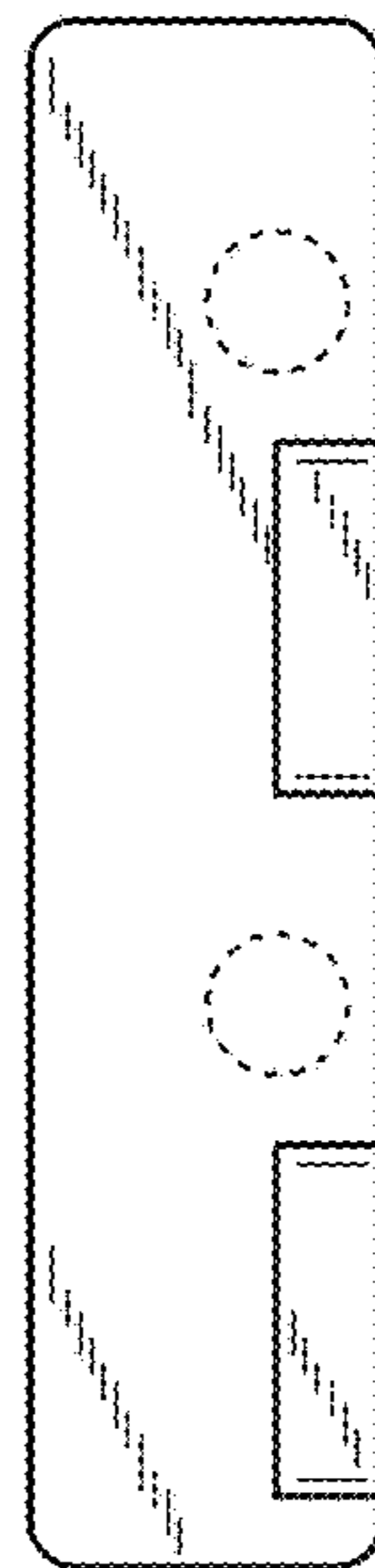

FIG. 10

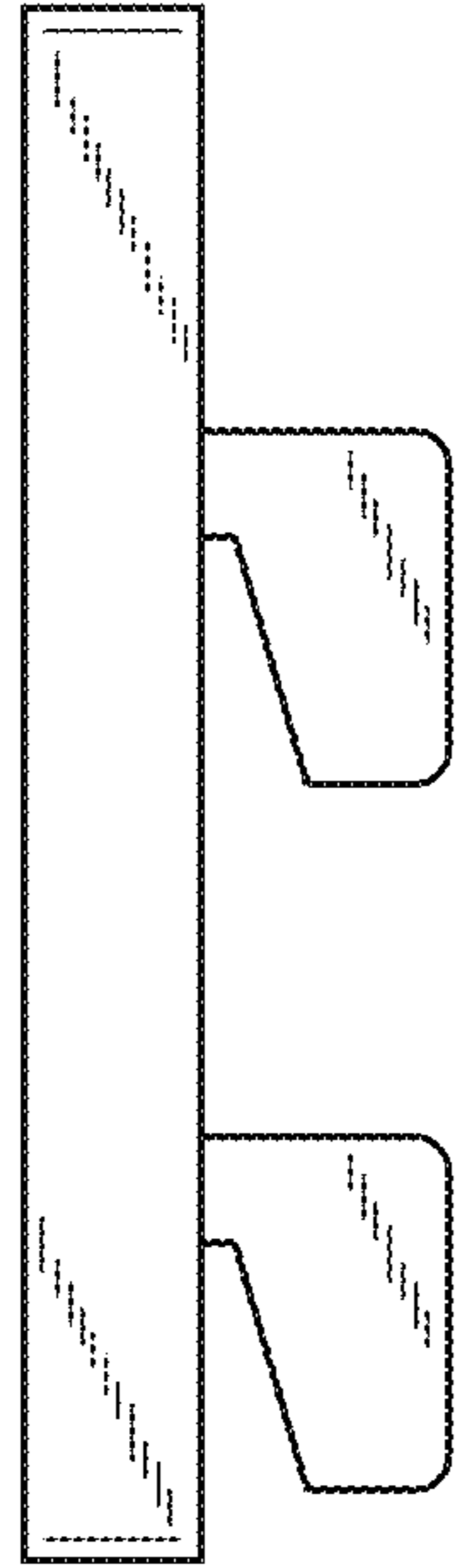

FIG. 11

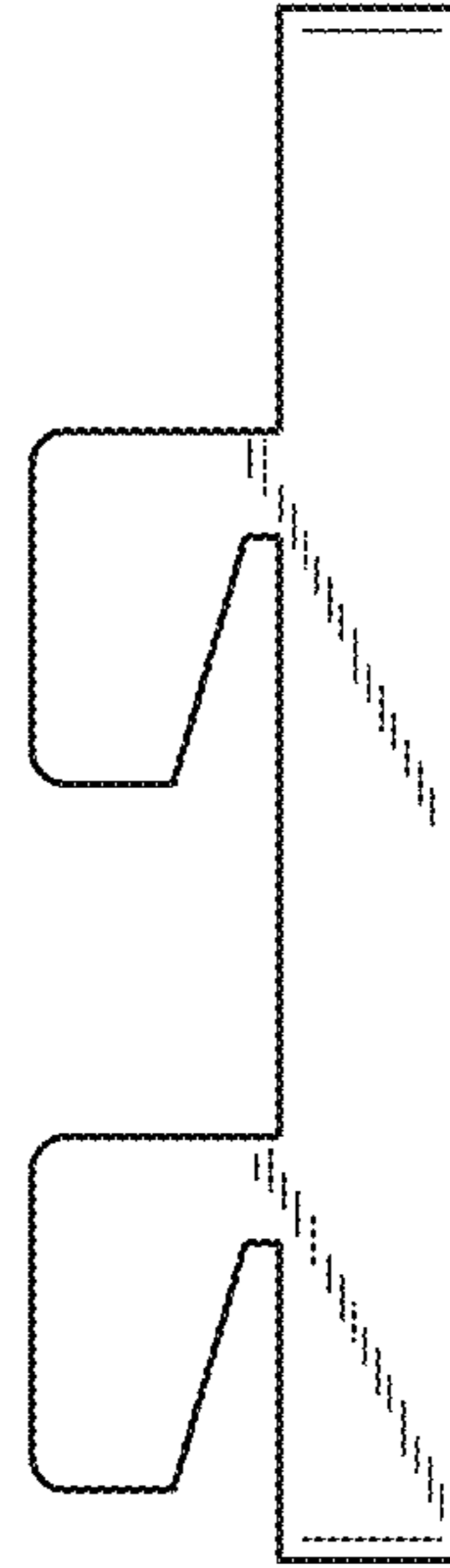

FIG. 12

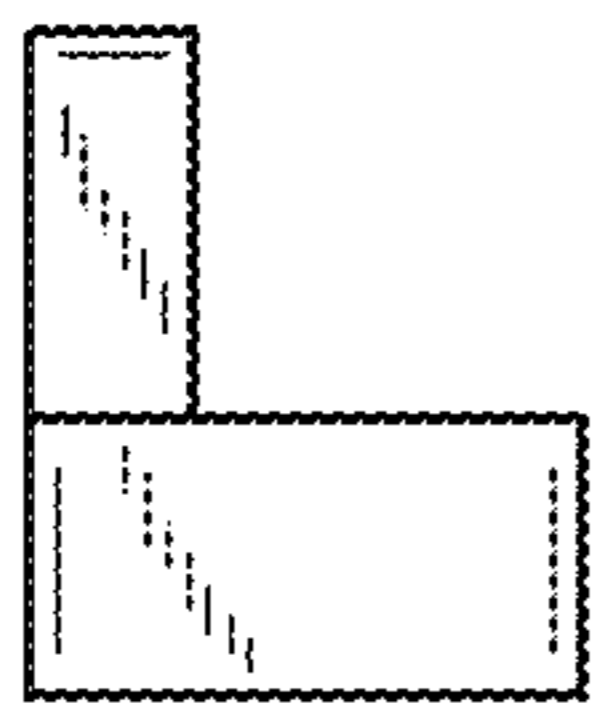

FIG. 13

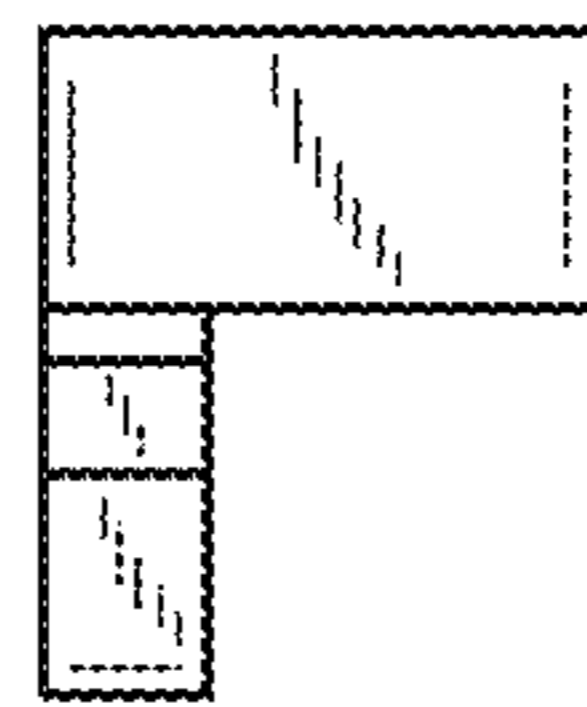

FIG. 14

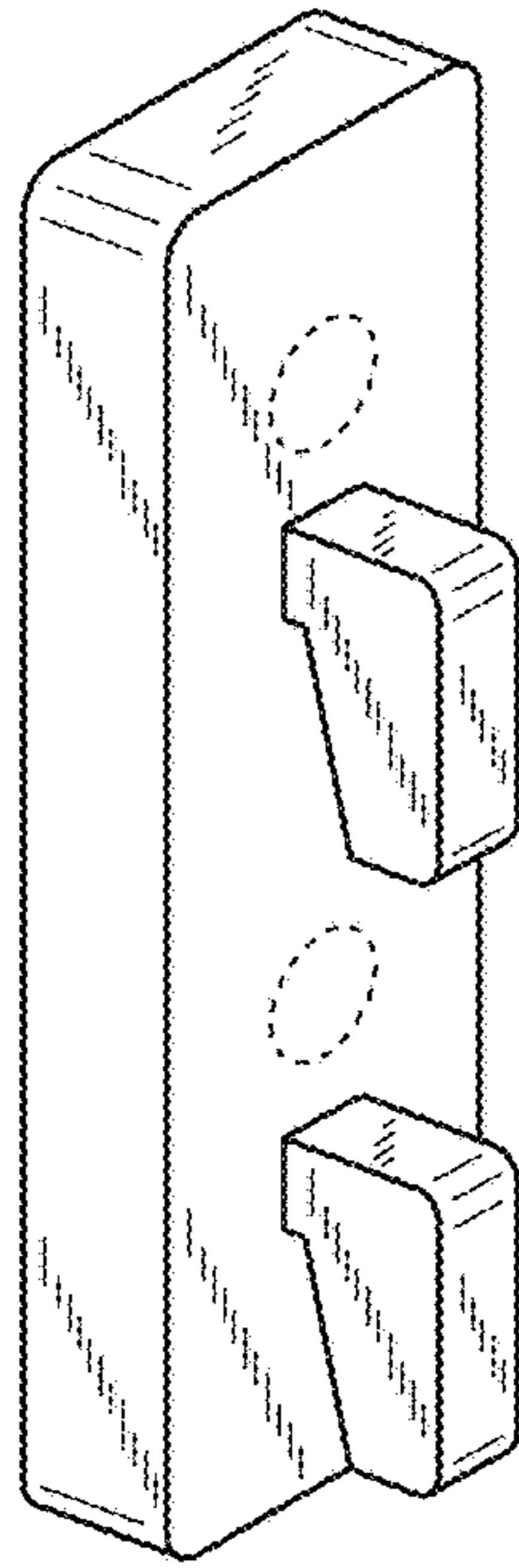

FIG. 15

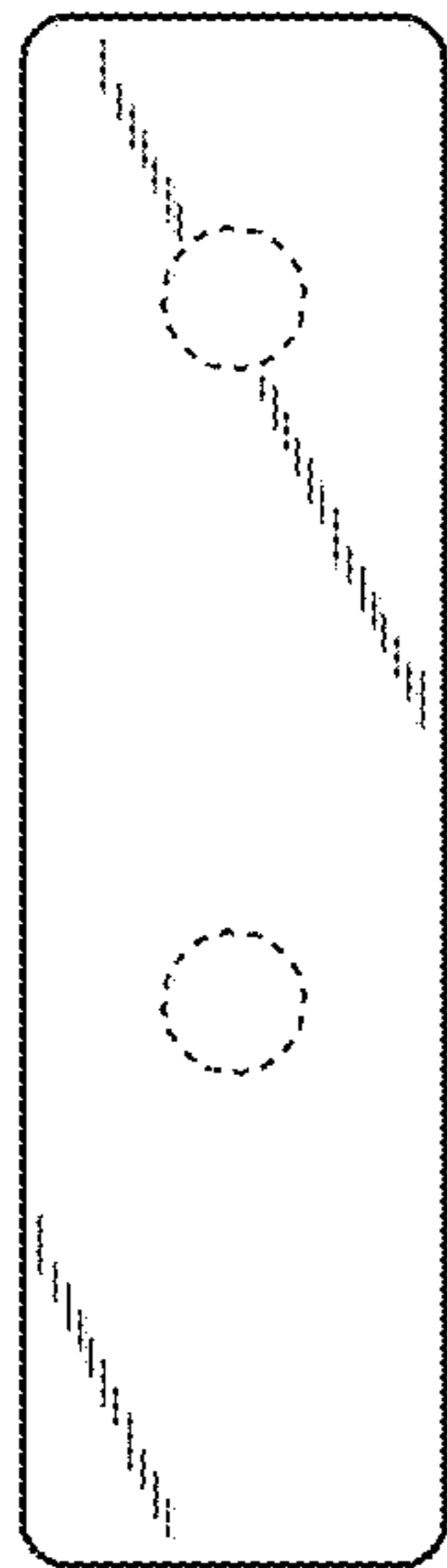

FIG. 16

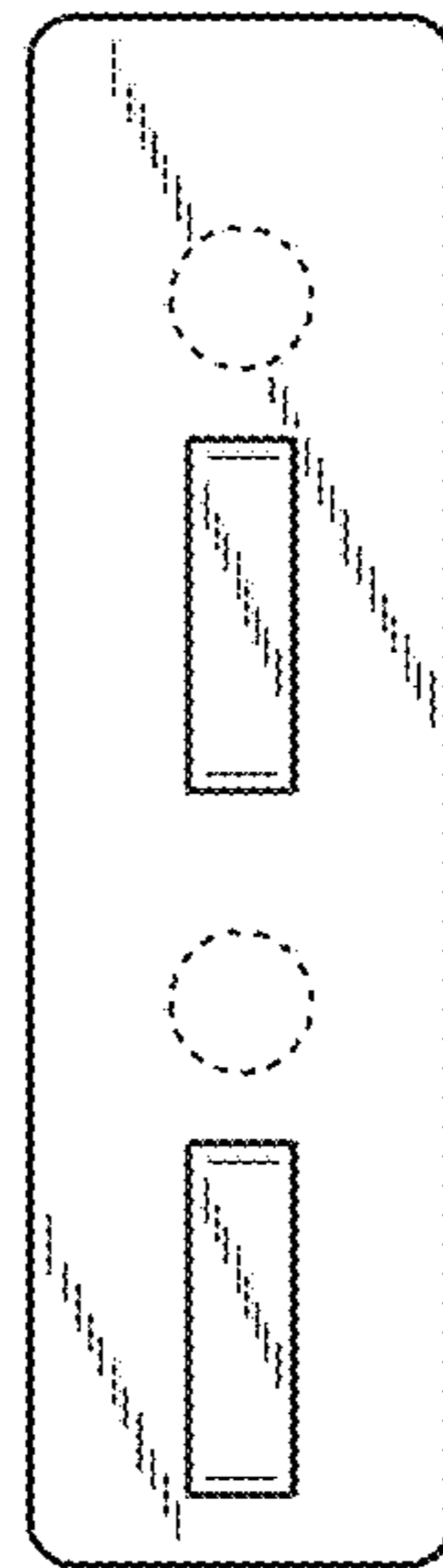

FIG. 17

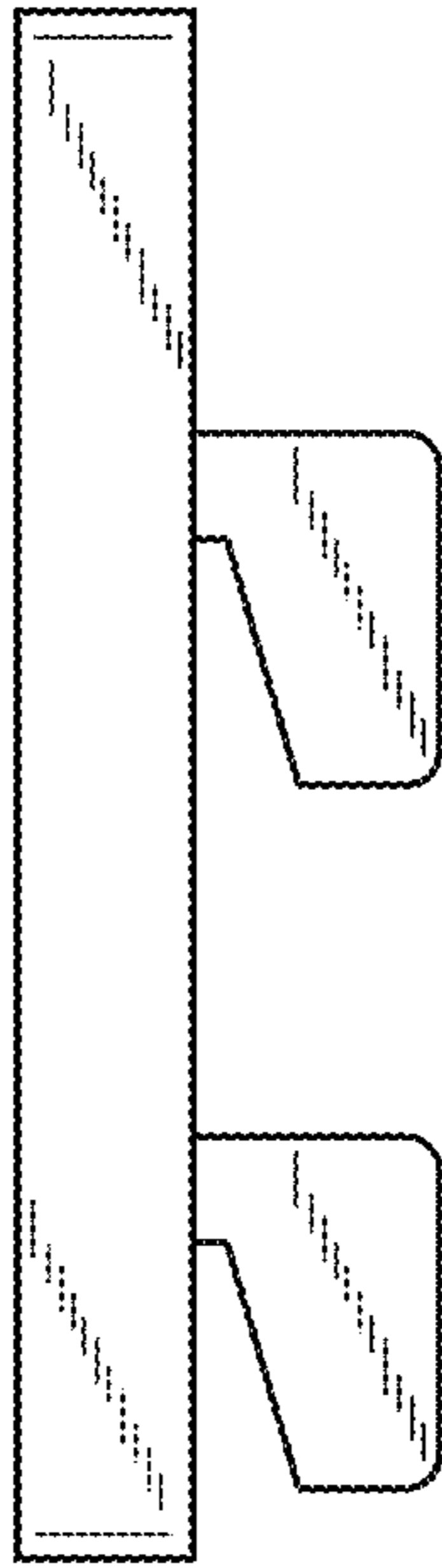

FIG. 18

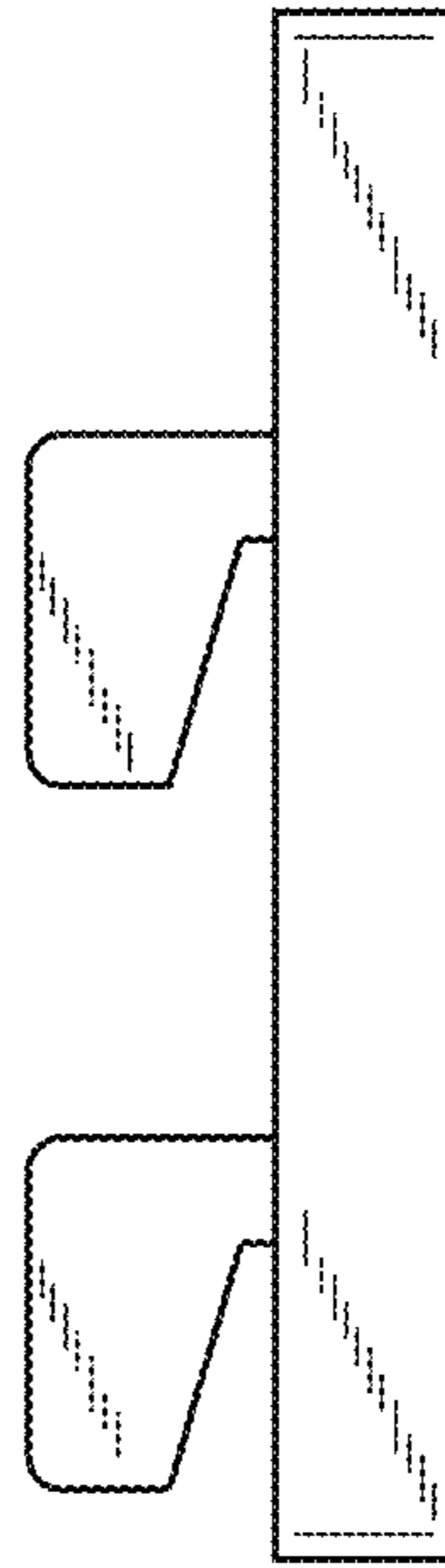

FIG. 19

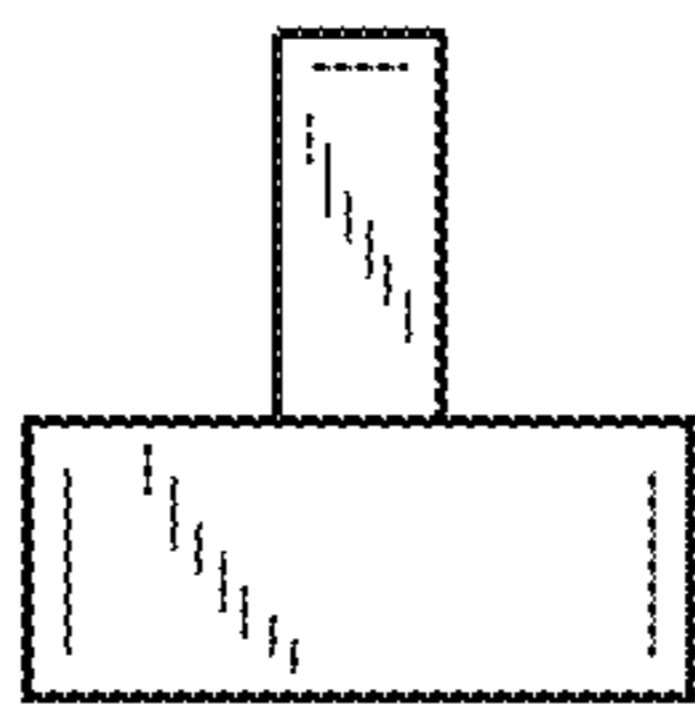

FIG. 20

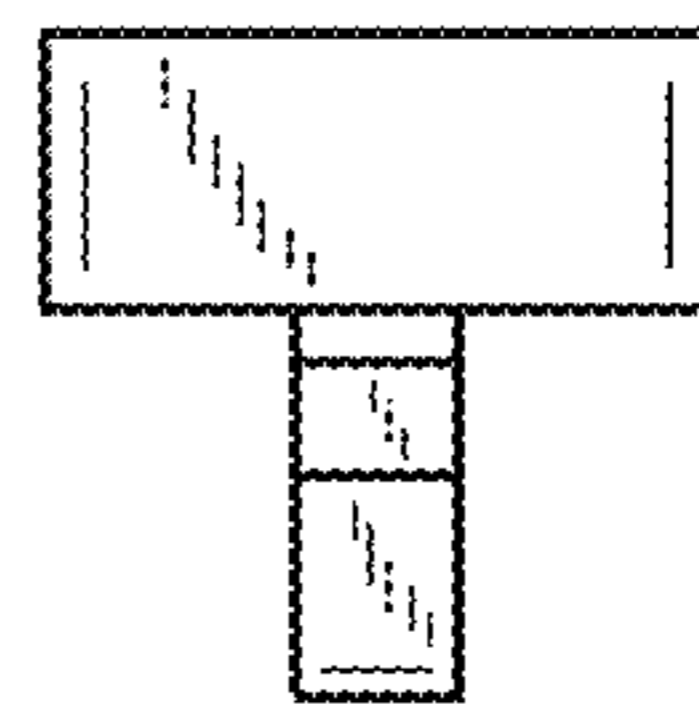

FIG. 21