



US00D832081S

(12) **United States Design Patent** (10) **Patent No.:** **US D832,081 S**  
**Gokcebay et al.** (45) **Date of Patent:** **\*\* Oct. 30, 2018**

(54) **ELECTRONIC CABINET LOCK FOR RECESS MOUNTING**

(71) Applicant: **Digilock Asia Ltd.**, Kowloon (HK)

(72) Inventors: **Asil T. Gokcebay**, Petaluma, CA (US);  
**Kelly Kodama**, Walnut Creek, CA (US)

(73) Assignee: **Digilock Asia Ltd.**, Kowloon (HK)

(\*\*) Term: **15 Years**

(21) Appl. No.: **29/625,169**

(22) Filed: **Nov. 7, 2017**

**Related U.S. Application Data**

(62) Division of application No. 29/570,534, filed on Jul. 8, 2016, now Pat. No. Des. 804,279.

(51) **LOC (11) Cl.** ..... **08-07**

(52) **U.S. Cl.**  
USPC ..... **D8/331; D8/330**

(58) **Field of Classification Search**  
USPC ..... D8/301, 302, 330, 331, 349, 400, 499;  
70/57, 57.1, 14, 20, 91, 92, 102, 141,  
70/237, 262, 263, 266, 278.1, 279.1, 416,  
70/465, 442, 443, 214, 78, 447; 340/5.6,  
340/5.61, 5.64, 5.73, 286.01, 542, 547,  
340/545.1, 545.7; 292/336.3, 257, 194,  
292/195, 198, 164, 165  
CPC ..... E05B 49/00; E05B 41/00; E05B 65/00;  
E05B 65/52; E05B 51/00; E05B 65/44;  
G07C 9/00571; G07C 9/00912  
See application file for complete search history.

(56) **References Cited**

**U.S. PATENT DOCUMENTS**

4,148,092 A 4/1979 Martin  
4,899,562 A 2/1990 Gartner

4,926,664 A 5/1990 Gartner et al.  
D327,856 S 7/1992 Loew et al.  
D331,888 S 12/1992 Lade  
D354,922 S 1/1995 Gartner  
5,481,361 A 1/1996 Yumiki et al.  
5,894,277 A 4/1999 Keskin et al.  
D426,833 S 6/2000 Vanelli  
6,272,562 B1 8/2001 Scott et al.  
D450,559 S 11/2001 Yu  
D580,739 S 11/2008 Pelletier et al.

(Continued)

*Primary Examiner* — R. Johnson

(74) *Attorney, Agent, or Firm* — Thomas M. Freiburger

(57) **CLAIM**

The ornamental design for an electronic cabinet lock for recess mounting, substantially as shown and described.

**DESCRIPTION**

FIG. 1 is a front left perspective view of a first embodiment of an electronic cabinet lock for recess mounting according to our new design;  
FIG. 2 is a top plan view thereof;  
FIG. 3 is a rear elevation view thereof;  
FIG. 4 is a left side view thereof;  
FIG. 5 is a front elevation view thereof;  
FIG. 6 is a right side view thereof;  
FIG. 7 is a bottom plan view thereof;  
FIG. 8 is a front left perspective view of a second embodiment of an electronic cabinet lock for recess mounting according to our new design;  
FIG. 9 is a top plan view thereof;  
FIG. 10 is a rear elevation view thereof;  
FIG. 11 is a left side view thereof;  
FIG. 12 is a front elevation view thereof;  
FIG. 13 is a right side view thereof; and,  
FIG. 14 is a bottom plan view thereof.  
Features shown in dashed lines are not part of the claimed design.

**1 Claim, 2 Drawing Sheets**

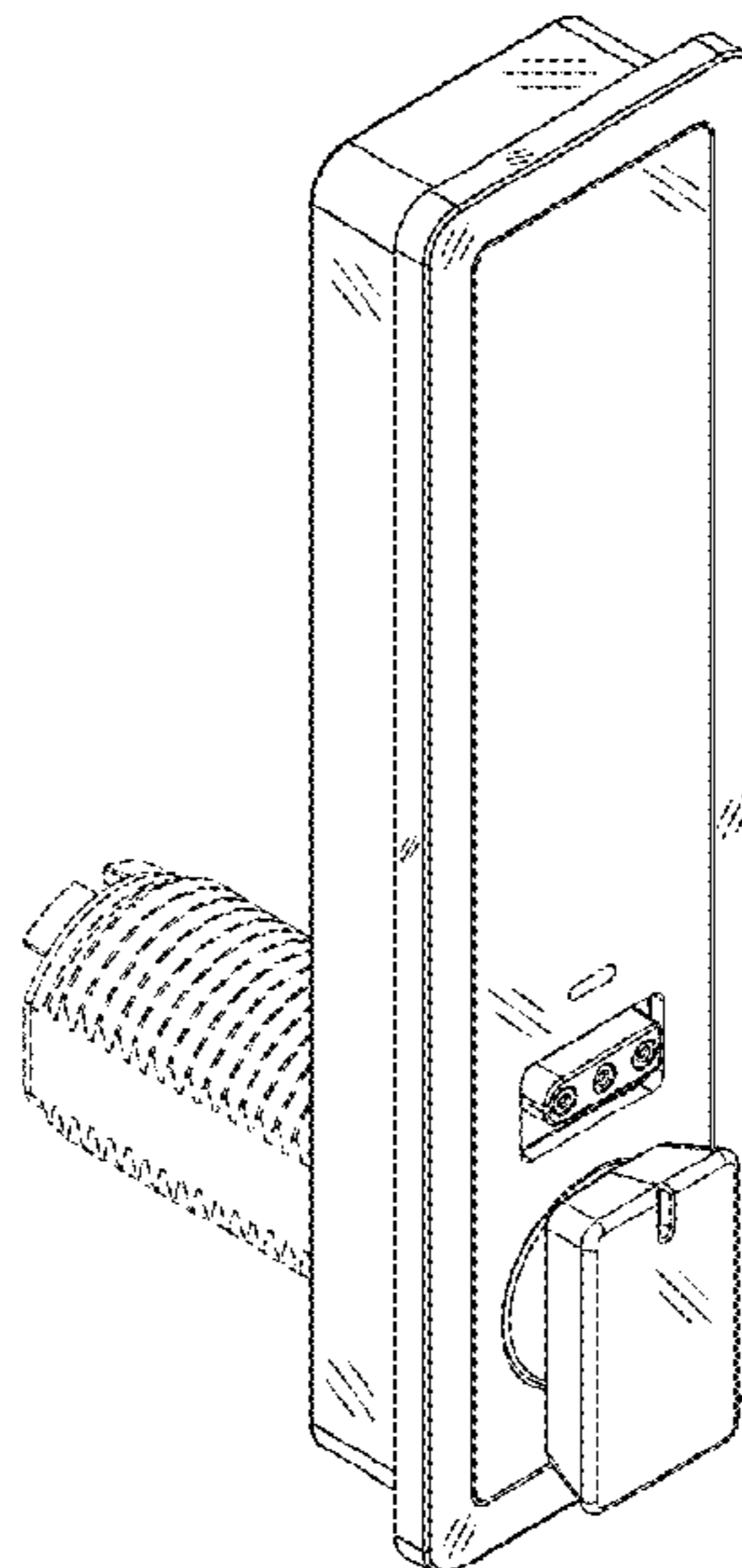
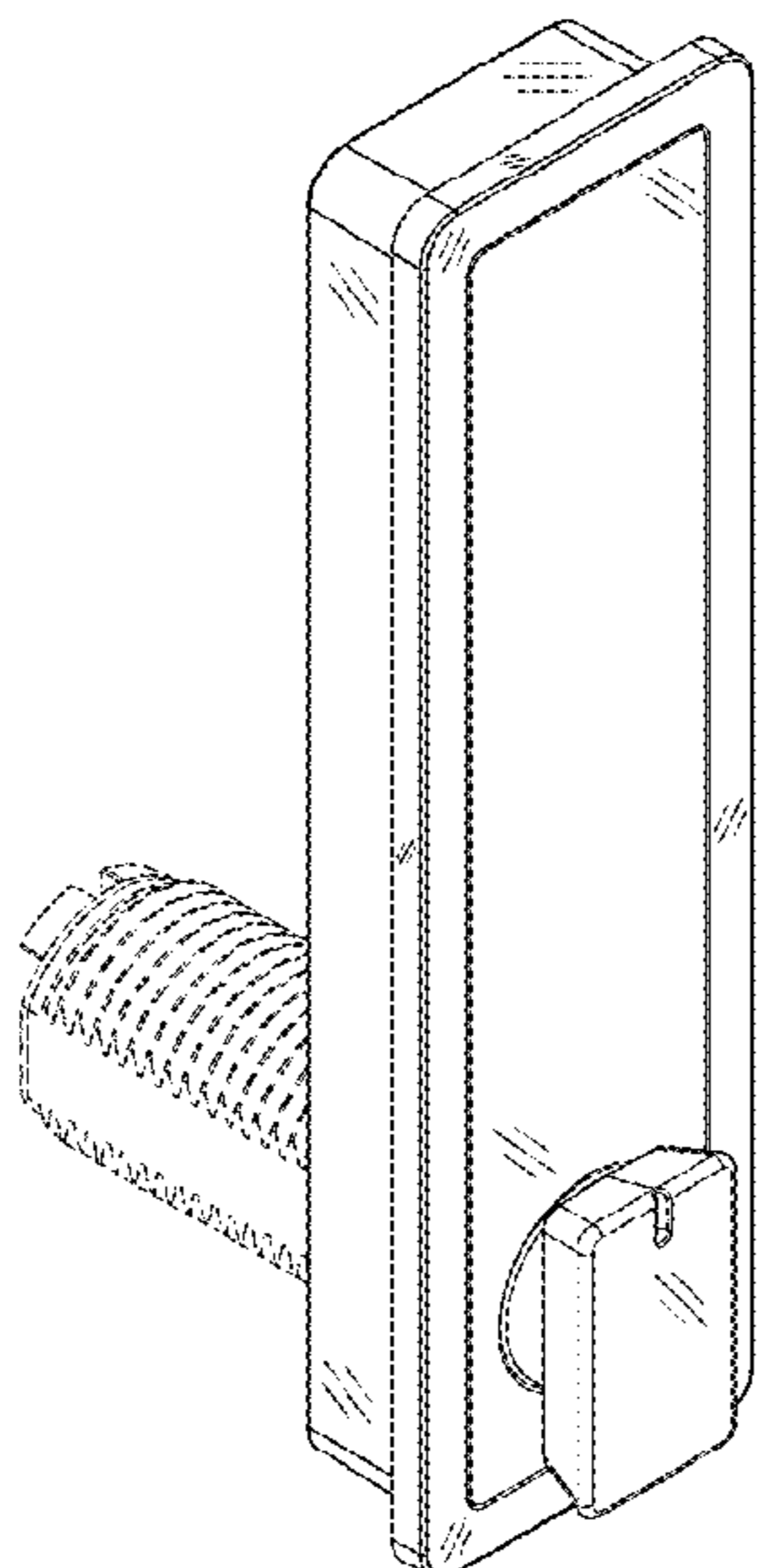

(56)

**References Cited**

## U.S. PATENT DOCUMENTS

|              |      |         |                 |                        |
|--------------|------|---------|-----------------|------------------------|
| 7,482,907    | B2   | 1/2009  | Denison et al.  |                        |
| D630,489     | S *  | 1/2011  | Gratzki .....   | D8/330                 |
| D686,055     | S *  | 7/2013  | Li .....        | D8/331                 |
| 8,495,898    | B2   | 7/2013  | Gokcebay        |                        |
| D730,712     | S    | 6/2015  | Gokcebay et al. |                        |
| D731,286     | S    | 6/2015  | Gokcebay et al. |                        |
| D731,287     | S    | 6/2015  | Gokcebay et al. |                        |
| D737,114     | S    | 8/2015  | Gokcebay et al. |                        |
| 9,208,628    | B2   | 12/2015 | Gokcebay        |                        |
| 9,222,283    | B1   | 12/2015 | Zhang et al.    |                        |
| 9,273,492    | B2   | 3/2016  | Gokcebay        |                        |
| D752,945     | S    | 4/2016  | Gokcebay et al. |                        |
| D752,947     | S    | 4/2016  | Gokcebay et al. |                        |
| D752,948     | S    | 4/2016  | Gokcebay et al. |                        |
| D752,949     | S    | 4/2016  | Gokcebay et al. |                        |
| D753,463     | S    | 4/2016  | Gokcebay et al. |                        |
| D762,100     | S    | 7/2016  | Gokcebay et al. |                        |
| D762,101     | S    | 7/2016  | Gokcebay et al. |                        |
| D762,102     | S *  | 7/2016  | Gokcebay .....  | D8/330                 |
| D762,103     | S    | 7/2016  | Gokcebay et al. |                        |
| D764,255     | S    | 8/2016  | Gokcebay et al. |                        |
| D764,892     | S    | 8/2016  | Gokcebay et al. |                        |
| D764,893     | S    | 8/2016  | Gokcebay et al. |                        |
| 9,536,359    | B1   | 1/2017  | Gokcebay        |                        |
| D791,577     | S *  | 7/2017  | Hetfield .....  | D8/330                 |
| D804,278     | S *  | 12/2017 | Gokcebay .....  | D8/331                 |
| D804,279     | S *  | 12/2017 | Gokcebay .....  | D8/331                 |
| 2007/0144226 | A1 * | 6/2007  | Miao .....      | E05B 37/16<br>70/214   |
| 2014/0318199 | A1 * | 10/2014 | Gokcebay .....  | E05C 3/042<br>70/278.1 |
| 2015/0211258 | A1 * | 7/2015  | Gokcebay .....  | E05B 47/06<br>70/278.1 |

\* cited by examiner

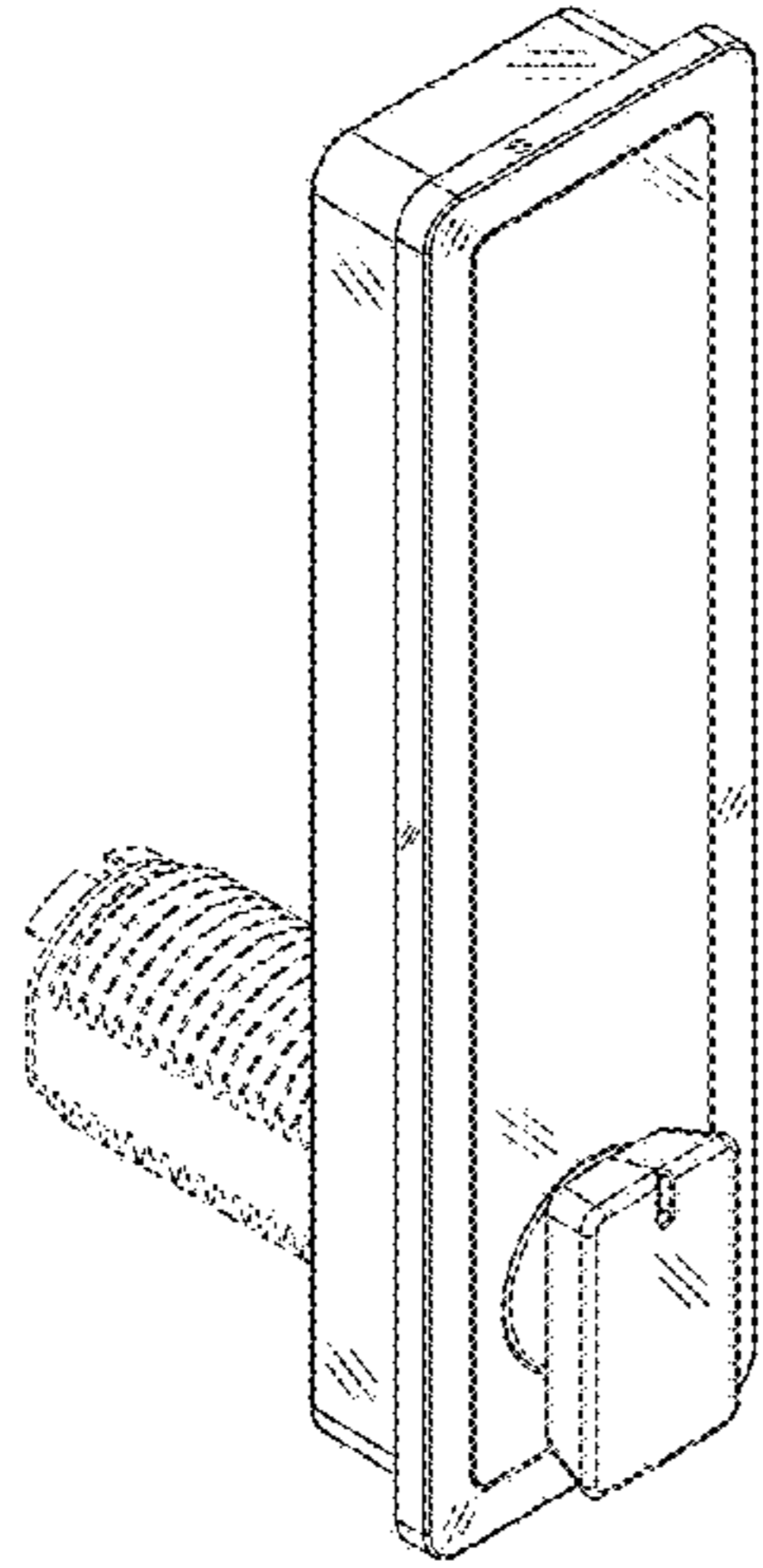

FIG. 1

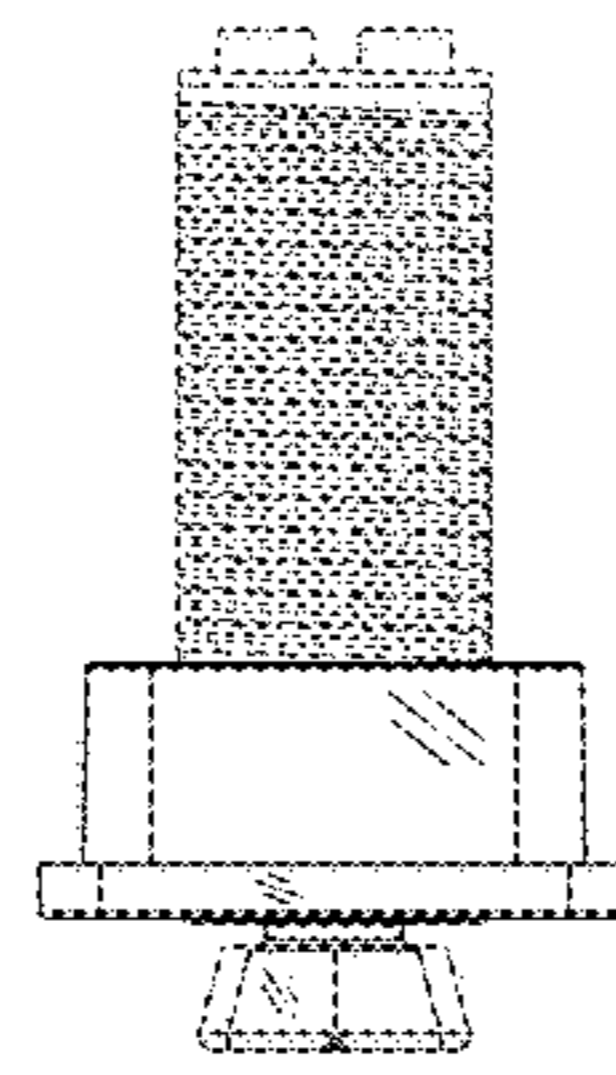

FIG. 2

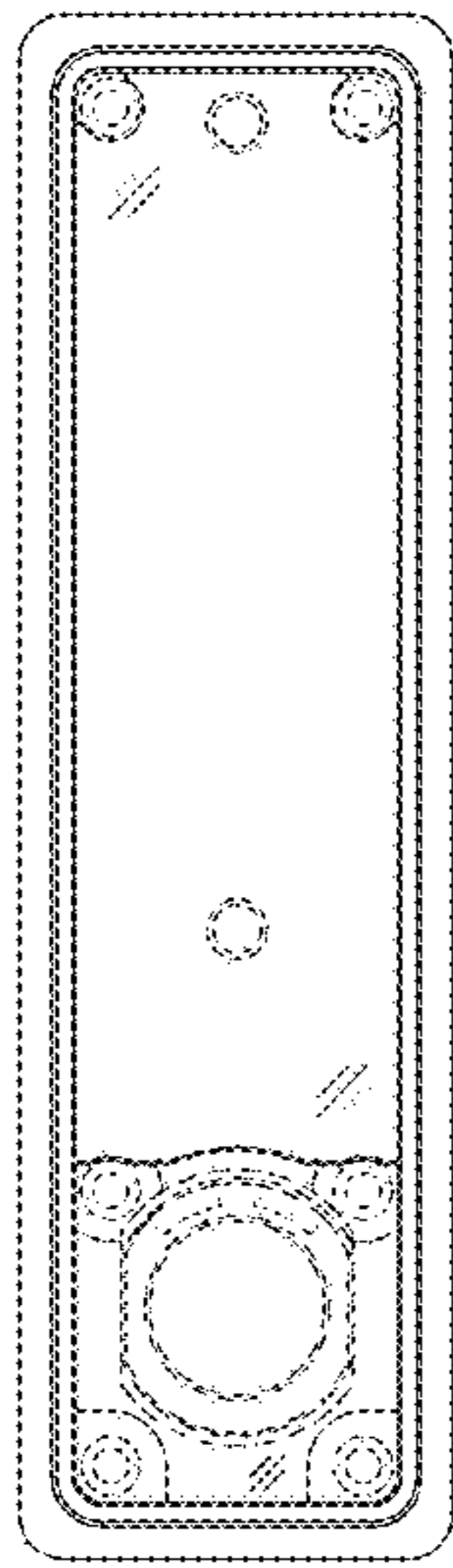

FIG. 3

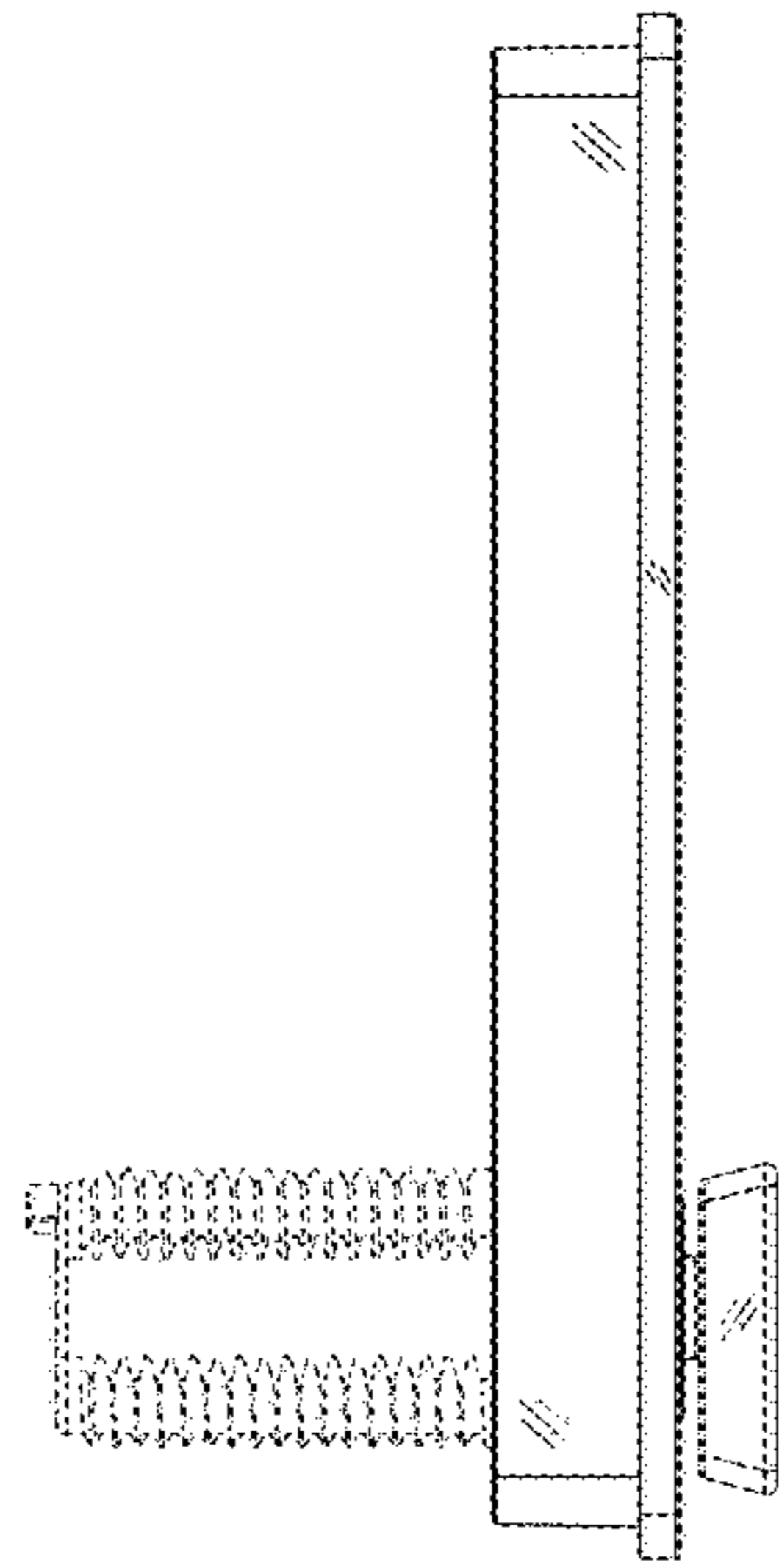

FIG. 4

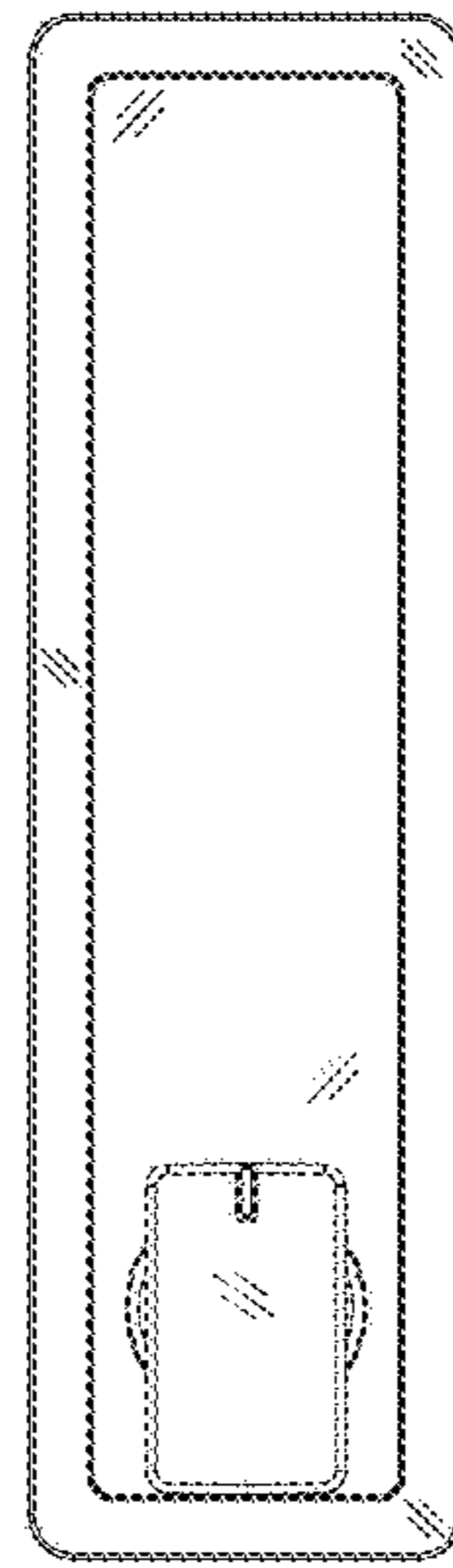

FIG. 5

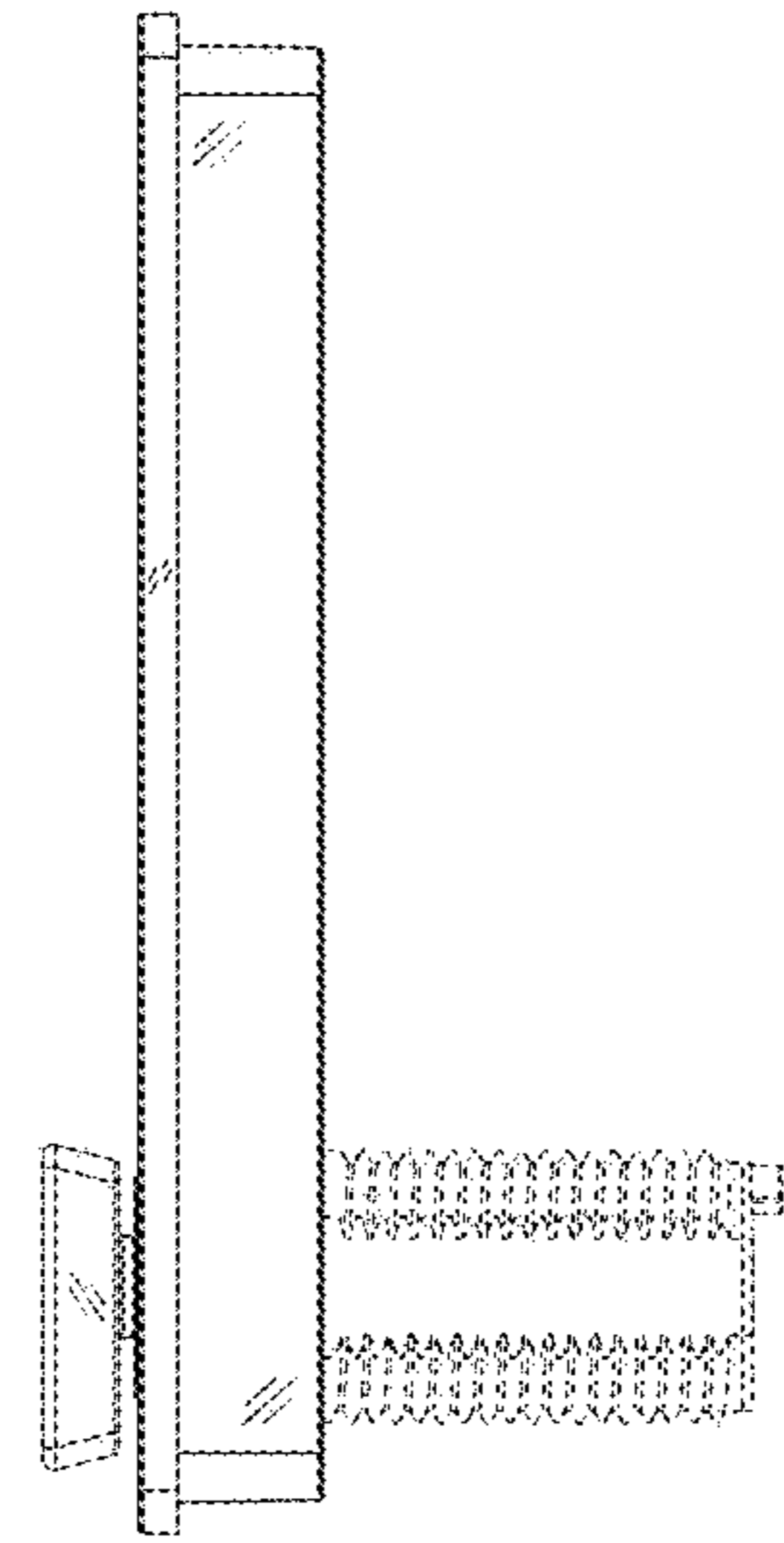

FIG. 6

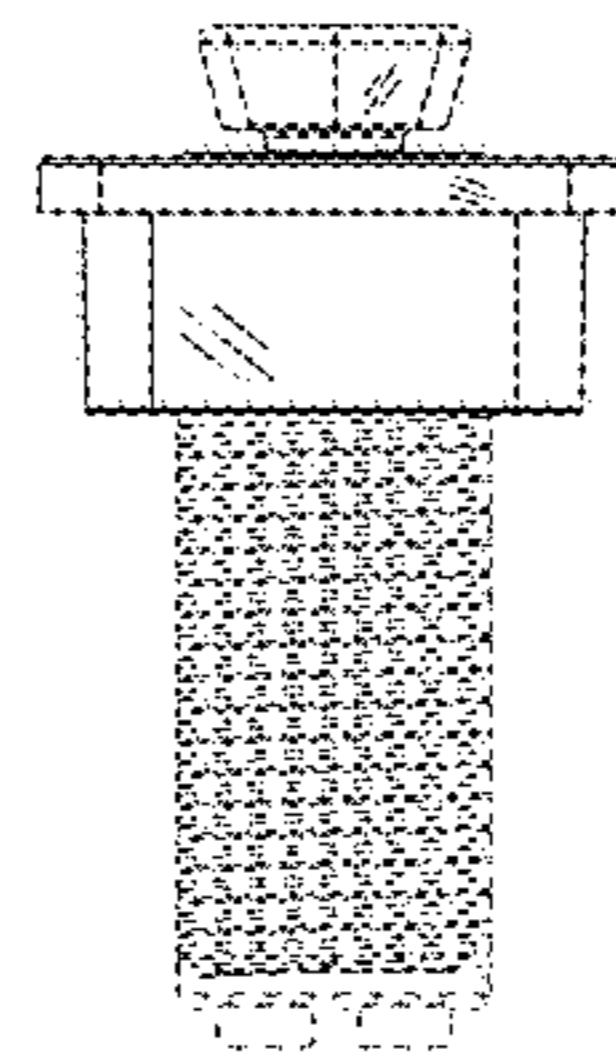

FIG. 7



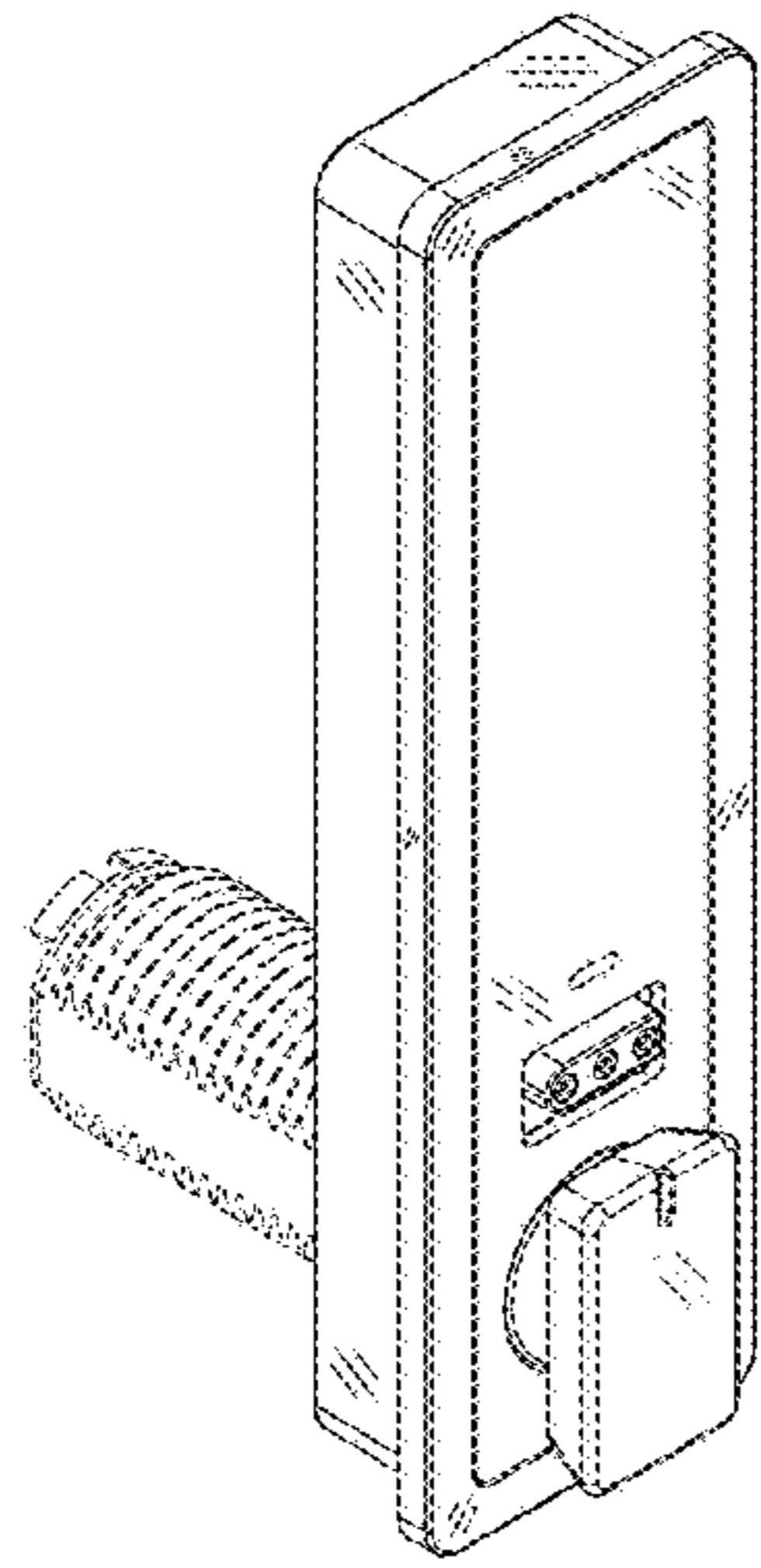

FIG. 8

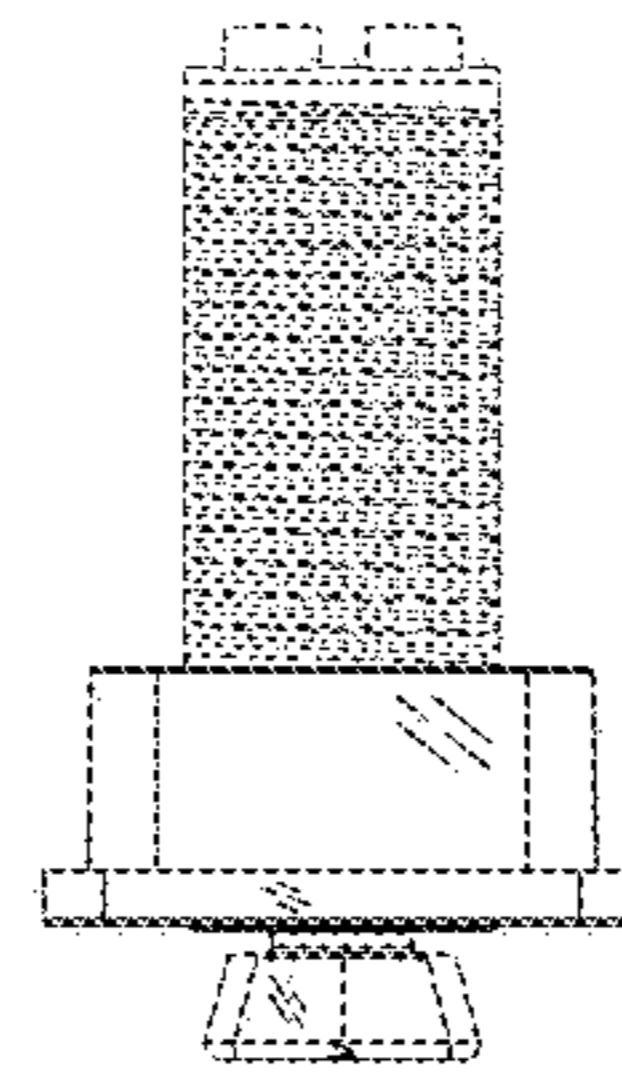

FIG. 9

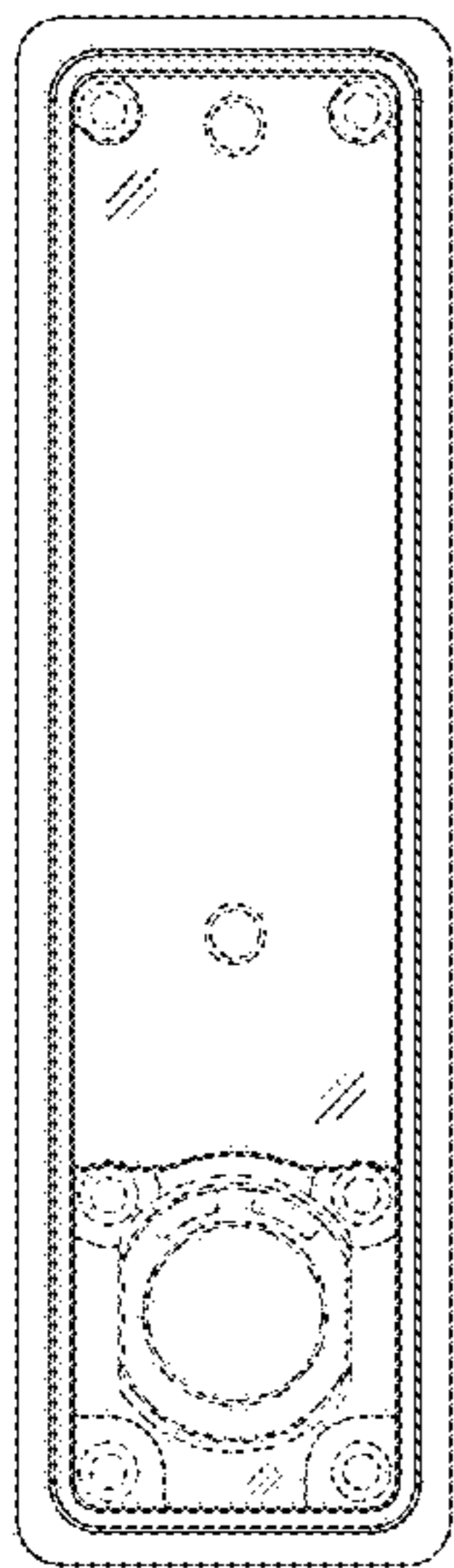

FIG. 10

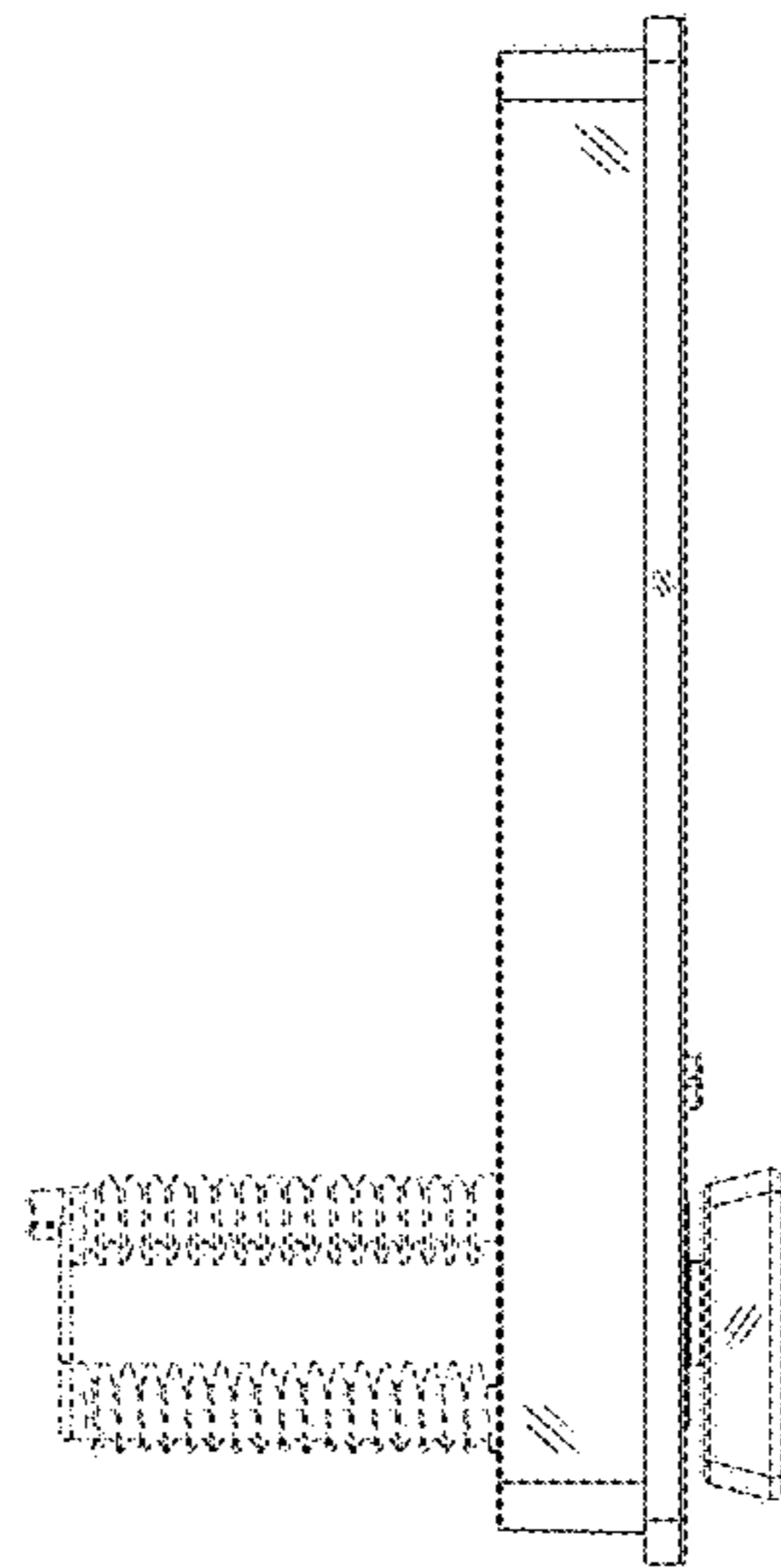

FIG. 11

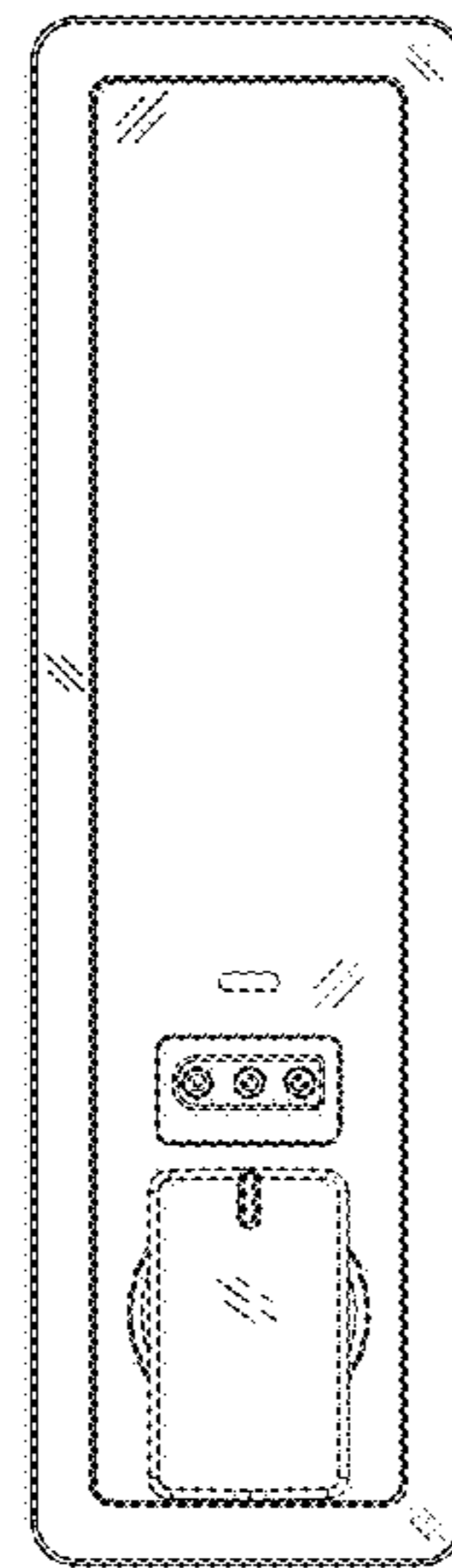

FIG. 12

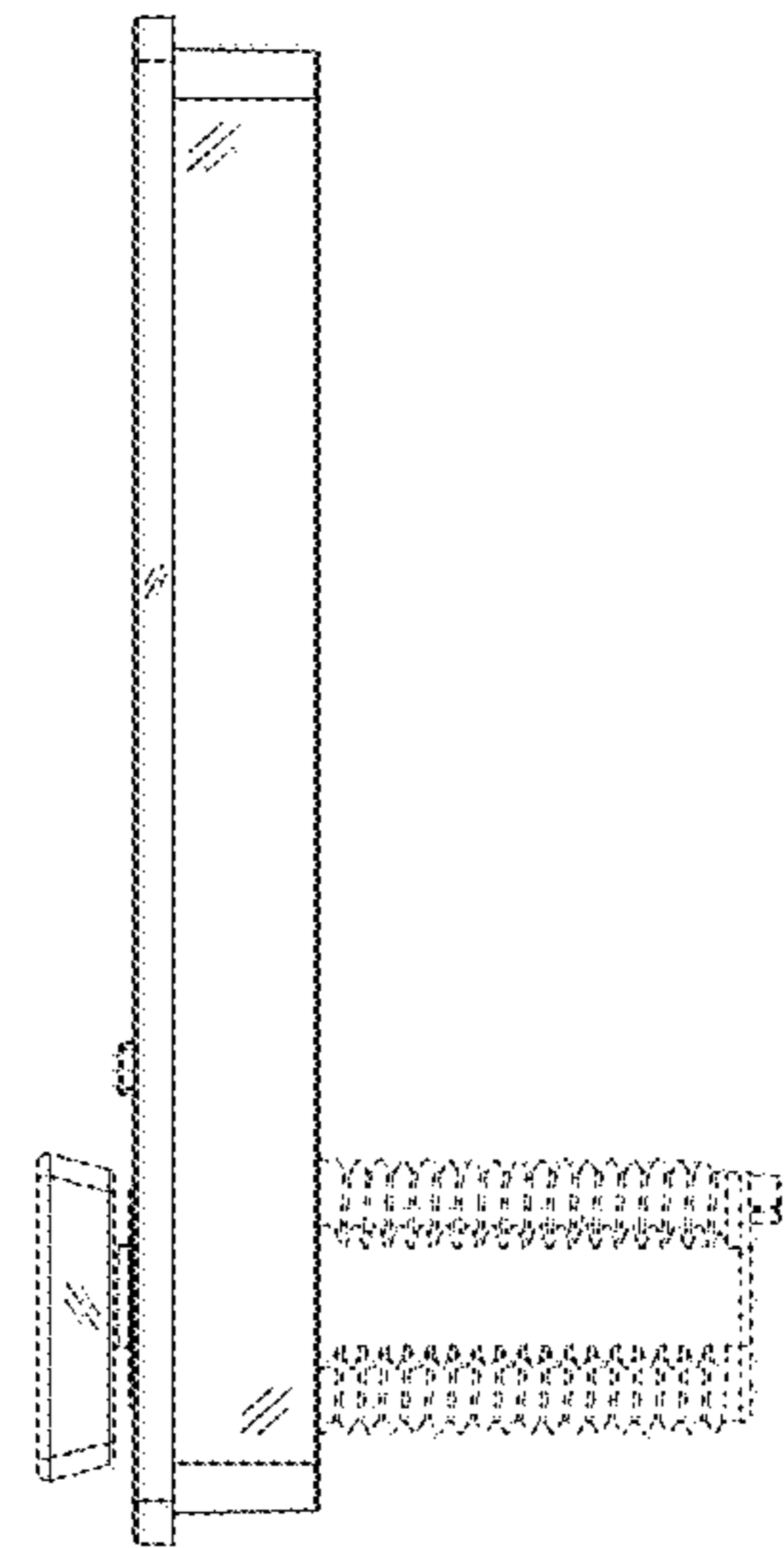

FIG. 13

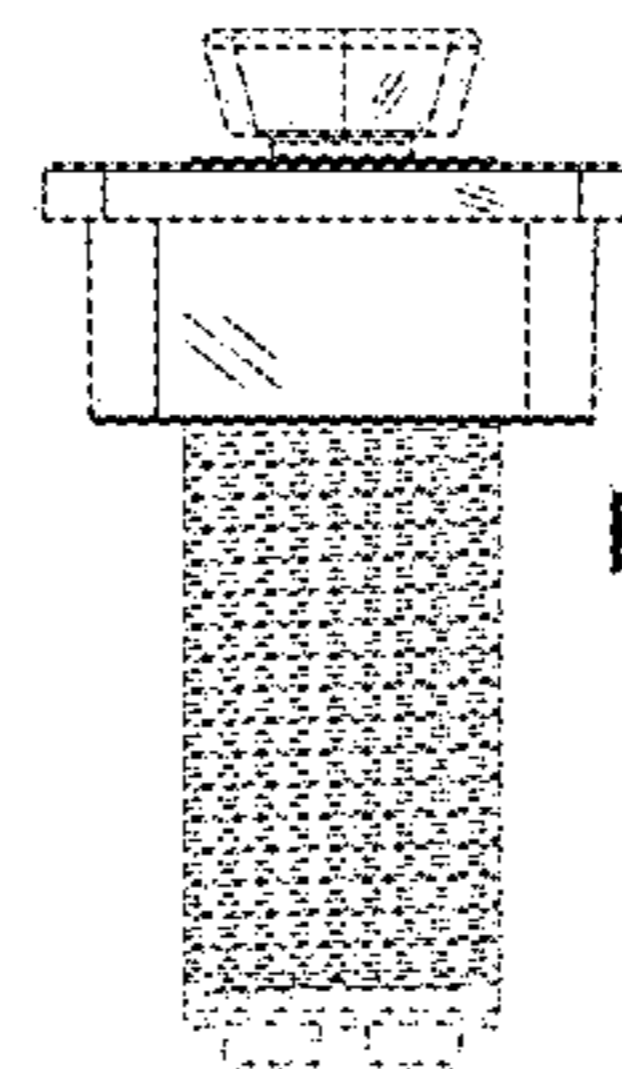

FIG. 14