



US00D832007S

(12) **United States Design Patent** (10) **Patent No.:** **US D832,007 S**
Gruppenhof (45) **Date of Patent:** **** Oct. 30, 2018**

(54) **DISPLAY UNIT WITH BUILT-IN SHELVING SUPPORTS**

(71) Applicant: **InnerWorkings, Inc.**, Chicago, IL (US)

(72) Inventor: **Austin G. Gruppenhof**, Hamilton, OH (US)

(73) Assignee: **Innerworkings, Inc.**, Chicago, IL (US)

(**) Term: **15 Years**

(21) Appl. No.: **29/588,438**

(22) Filed: **Dec. 20, 2016**

(51) **LOC (11) Cl.** **06-04**

(52) **U.S. Cl.**
USPC **D6/674**

(58) **Field of Classification Search**

USPC D6/672, 674, 674.1, 678, 678.1
CPC A47F 1/12; A47F 3/0439; A47F 3/0465;
A47F 5/0018; A47F 5/005; A47F 5/11;
A47F 7/0071; A47F 2007/0092

See application file for complete search history.

(56) **References Cited**

U.S. PATENT DOCUMENTS

D38,720 S *	8/1907	Soellner et al.	D6/674
D111,736 S *	10/1938	De Sabato et al.	D6/674
D208,340 S *	8/1967	Pollenz et al.	D6/674
D232,204 S *	7/1974	Kaner et al.	D6/674
D233,388 S *	10/1974	Moss et al.	D6/674
D256,644 S	9/1980	Marks	
D259,684 S *	6/1981	Davis	D6/674
D279,442 S	7/1985	Silver	
D294,441 S	3/1988	Hoch	
D296,737 S	7/1988	Bezzarides et al.	
D307,839 S *	5/1990	Johnson, Jr.	D6/674
D314,296 S	2/1991	Mason	
D323,262 S	1/1992	Flum	
D340,369 S	10/1993	Dokoupil et al.	
D344,419 S	2/1994	Stoddart	

(Continued)

OTHER PUBLICATIONS

Gruppenhof, Quayle Office Action, U.S. Appl. No. 29/588,435, dated Aug. 23, 2017, 4 pgs.

(Continued)

Primary Examiner — John Windmuller

Assistant Examiner — Steven J Czyz

(74) *Attorney, Agent, or Firm* — Morgan, Lewis & Bockius LLP

(57) **CLAIM**

An ornamental design for a display unit with built-in shelving supports, substantially as shown.

DESCRIPTION

This application is related to the following design applications: U.S. design patent application Ser. No. 29/588,432; U.S. design patent application Ser. No. 29/588,433; U.S. design patent application Ser. No. 29/588,435; U.S. design patent application Ser. No. 29/588,436; U.S. design patent application Ser. No. 29/588,440; U.S. design patent application Ser. No. 29/588,441; U.S. design patent application Ser. No. 29/588,442; U.S. design patent application Ser. No. 29/588,443; and U.S. design patent application Ser. No. 29/588,444. Each of these related design applications is hereby incorporated by reference in its entirety.

FIG. 1 is a perspective view of a display unit with built-in shelving supports.

FIG. 2 is a top view thereof.

FIG. 3 is a bottom view thereof.

FIG. 4 is a front view thereof.

FIG. 5 is a rear view thereof.

FIG. 6 is a first side view thereof; and,

FIG. 7 is a second side view thereof.

The broken lines depict portions of the article that form no part of the claimed design.

1 Claim, 5 Drawing Sheets

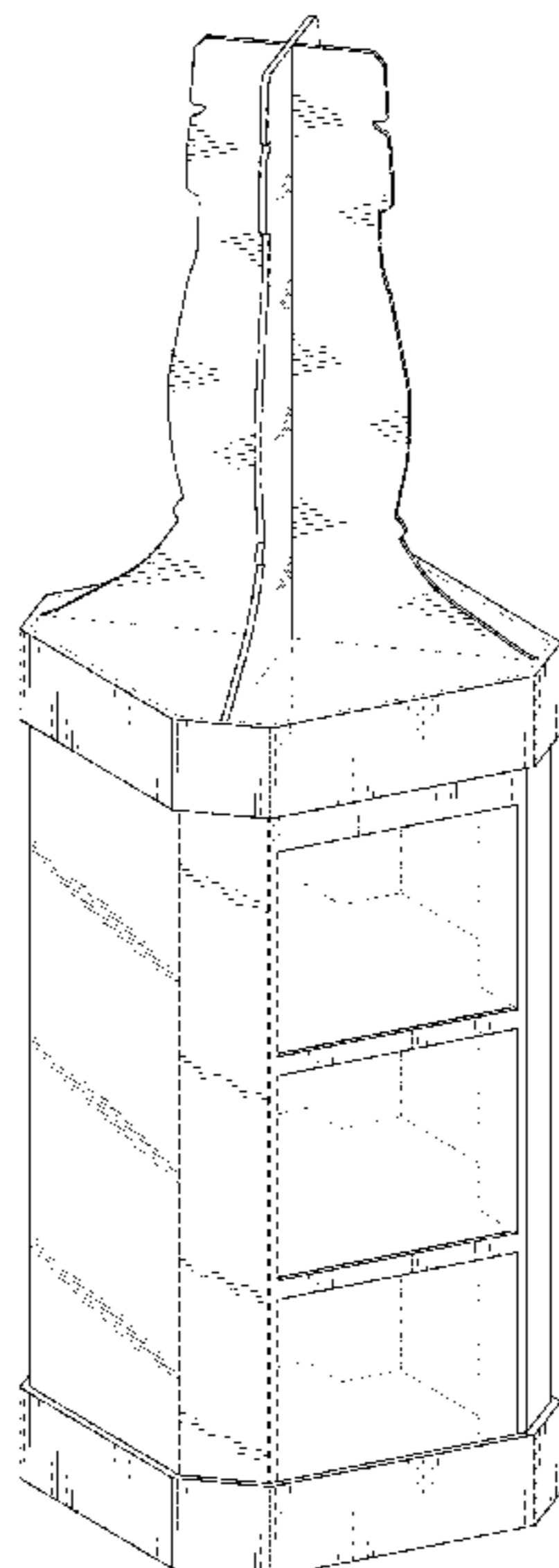

(56)

References Cited

U.S. PATENT DOCUMENTS

D383,332 S * 9/1997 Schneider D6/674
 D385,438 S * 10/1997 Jay D6/674
 D390,723 S * 2/1998 Jay D6/674
 D396,581 S 8/1998 Schubert
 D418,331 S 1/2000 Christescu
 D421,350 S * 3/2000 Bidwell D6/674
 D421,687 S 3/2000 Curci
 D438,729 S * 3/2001 Sikora D11/118
 D450,488 S 11/2001 Stone et al.
 D452,393 S * 12/2001 Bedard D6/674
 D456,176 S * 4/2002 Dashefsky D28/73
 D474,351 S * 5/2003 Lyons D6/630
 D477,158 S 7/2003 Calcerano et al.
 D483,201 S * 12/2003 Berish D6/674
 D487,549 S * 3/2004 Berish D6/674
 D496,193 S 9/2004 Mason
 D496,194 S 9/2004 Mason
 D500,810 S * 1/2005 Osigwe D20/37
 D530,290 S * 10/2006 Dupuis D14/125
 7,131,543 B2 11/2006 Mason
 D537,652 S * 3/2007 MacDonald D6/630
 D602,710 S * 10/2009 Thurston D6/674
 D629,232 S 12/2010 Forcellina
 D675,040 S 1/2013 Koenigsknecht et al.
 D684,795 S 6/2013 Koenigsknecht et al.
 D690,139 S 9/2013 Trinh et al.
 D691,838 S 10/2013 Hinkle
 8,763,941 B1 * 7/2014 Beck, Jr. B02C 19/0093
 241/100
 D712,689 S 9/2014 Montagner
 D731,823 S 6/2015 Kelinske et al.
 D734,068 S 7/2015 Dworman
 D737,078 S 8/2015 McKinney

D745,298 S 12/2015 Workman et al.
 9,215,940 B2 12/2015 Kawkins
 D747,902 S 1/2016 Matloff
 D748,934 S * 2/2016 Arrington-Brown D6/674
 D768,278 S * 10/2016 Kumar D23/367
 D775,871 S 1/2017 Volz et al.
 D777,489 S 1/2017 Stauss
 D784,055 S 4/2017 Arzaluz
 D797,477 S 9/2017 Horsky et al.

OTHER PUBLICATIONS

Grupenhof, Notice of Allowance, U.S. Appl. No. 29/588,435, dated Feb. 26, 2018, 5 pgs.
 Grupenhof, Notice of Allowance, U.S. Appl. No. 29/588,432, dated Oct. 6, 2017, 7 pgs.
 Grupenhof, Office Action, U.S. Appl. No. 29/588,440, dated Sep. 22, 2017, 5 pgs.
 Grupenhof, Notice of Allowance, U.S. Appl. No. 29/588,436, dated Oct. 10, 2017, 7 pgs.
 Grupenhof, Notice of Allowance, U.S. Appl. No. 29/588,433, dated Oct. 11, 2017, 7 pgs.
 Grupenhof, Office Action, U.S. Appl. No. 29/588,441, dated Oct. 31, 2017, 5 pgs.
 Grupenhof, Final Office Action, U.S. Appl. No. 29/588,441, dated Mar. 9, 2018, 4 pgs.
 Grupenhof, Notice of Allowance, U.S. Appl. No. 29/588,442, dated Oct. 10, 2017, 7 pgs.
 Grupenhof, Notice of Allowance, U.S. Appl. No. 29/588,444, dated Oct. 10, 2017, 7 pgs.
 Grupenhof, Office Action, U.S. Appl. No. 29/588,443, dated Oct. 19, 2017, 5 pgs.

* cited by examiner

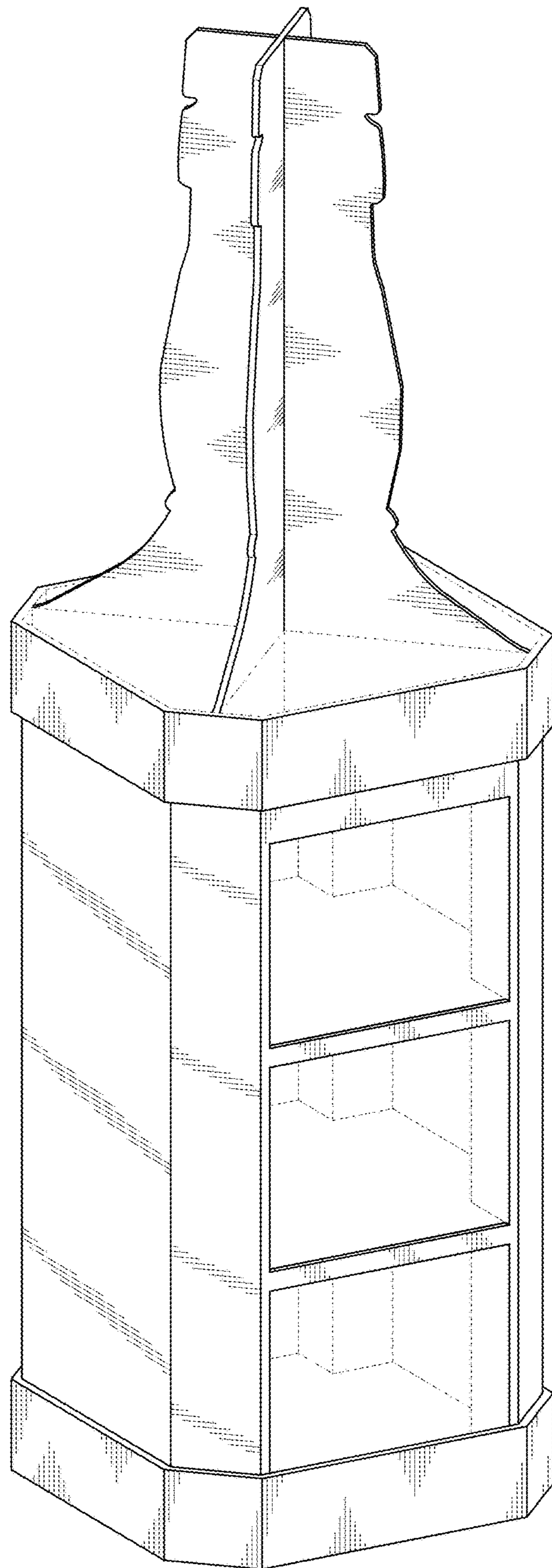

FIG. 1

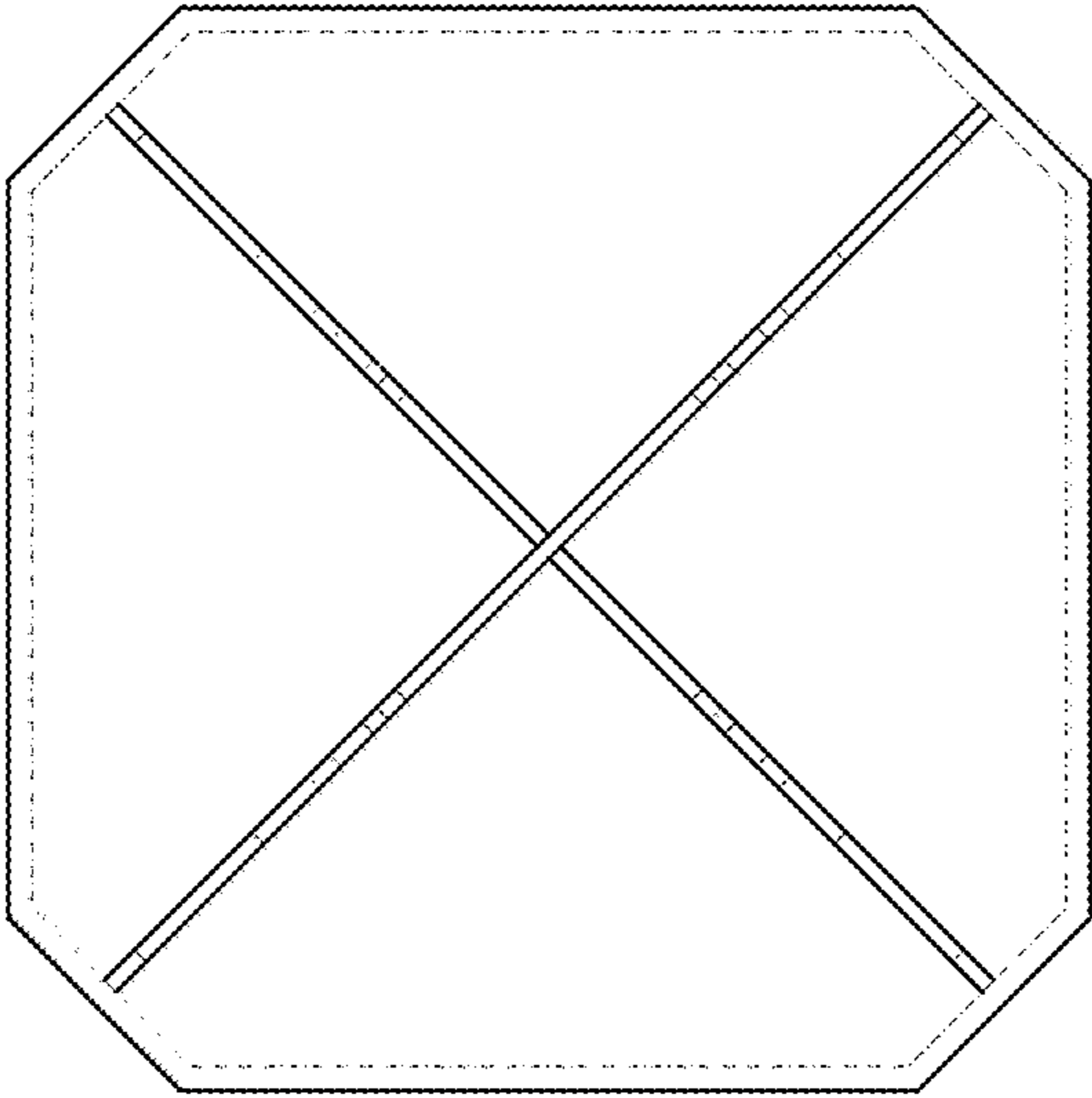

FIG. 2

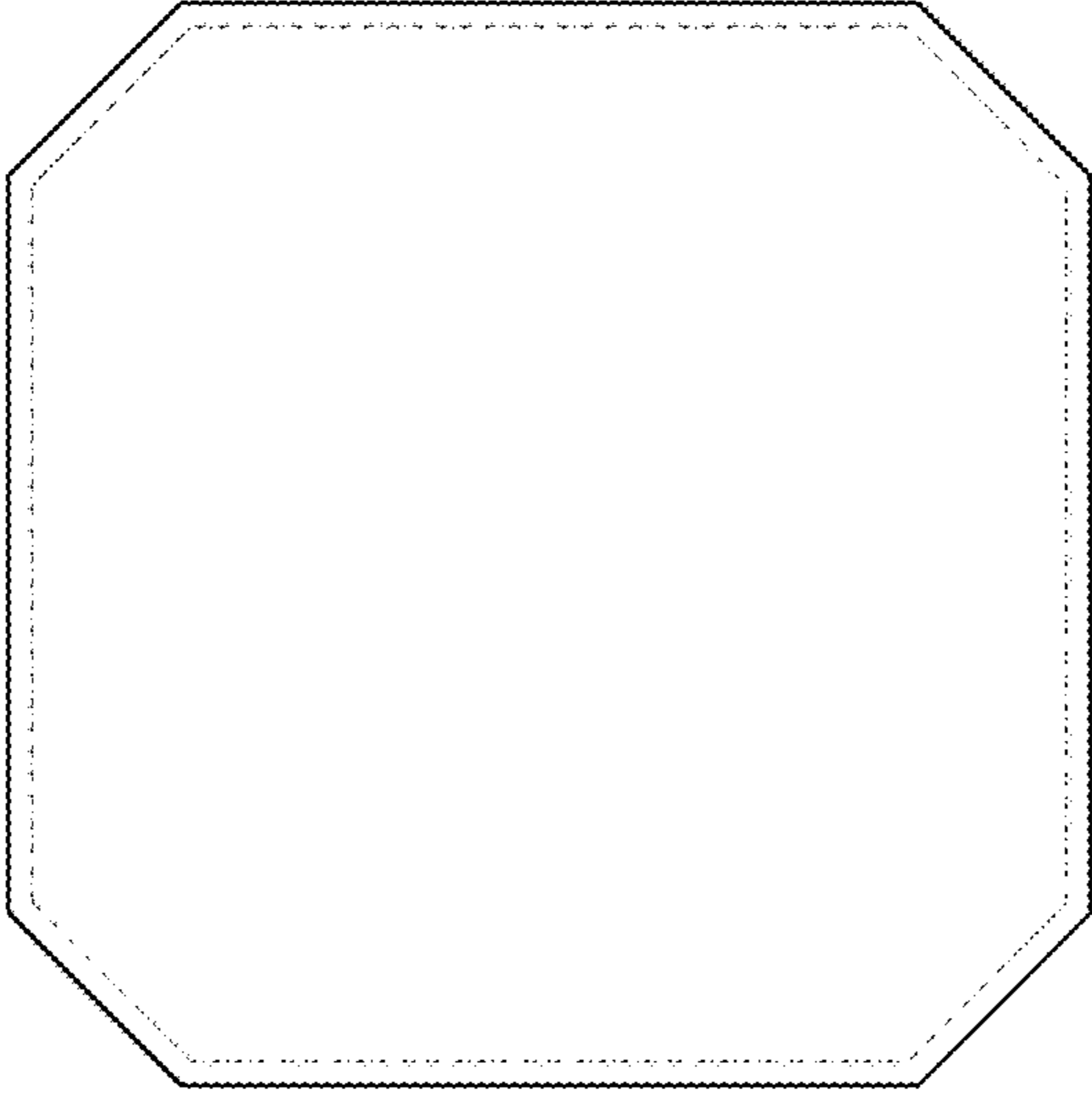

FIG. 3

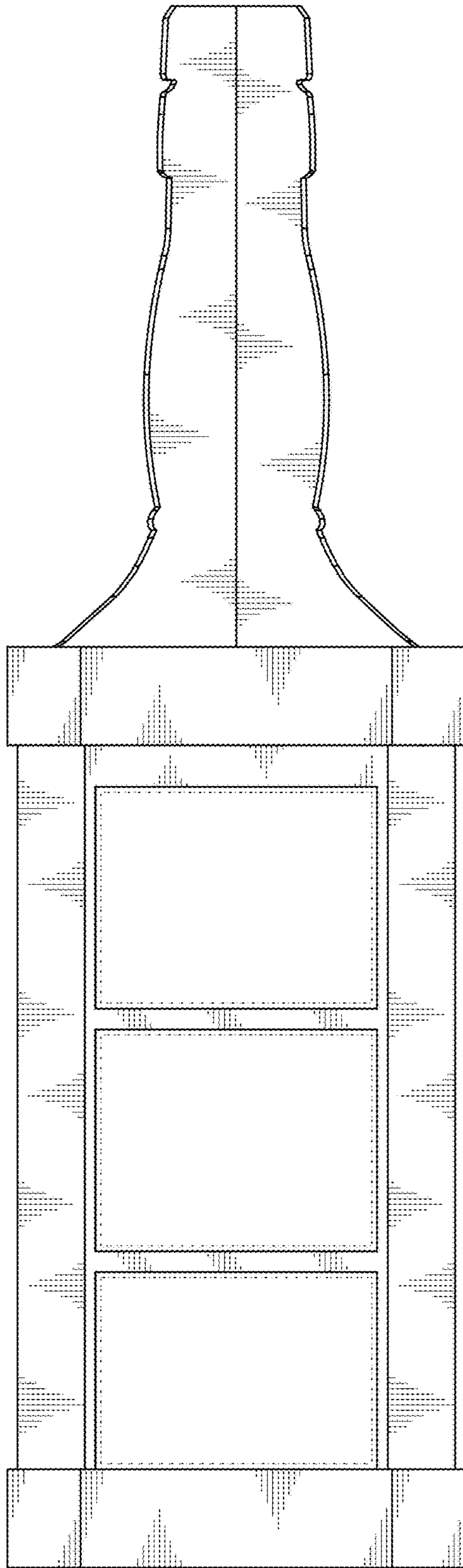

FIG. 4

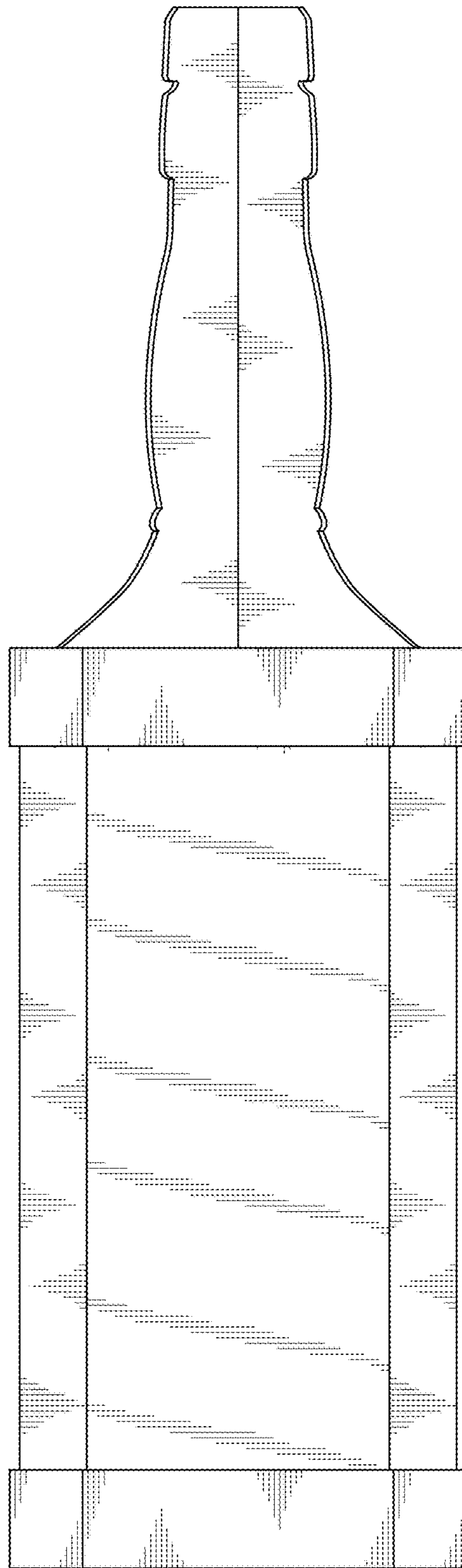

FIG. 5

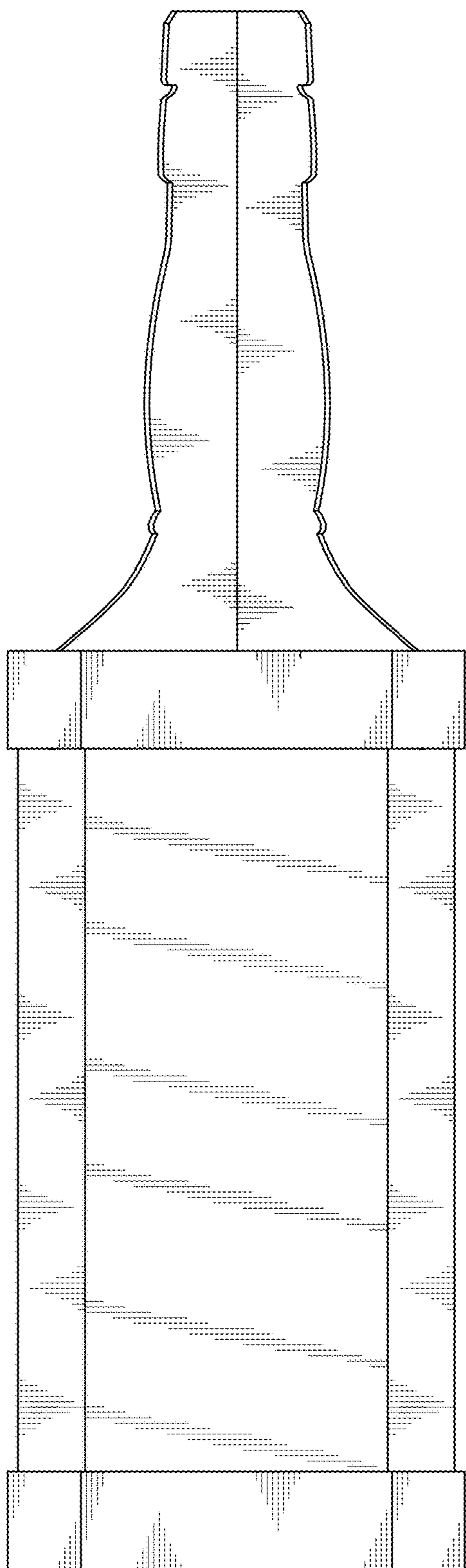

FIG. 6

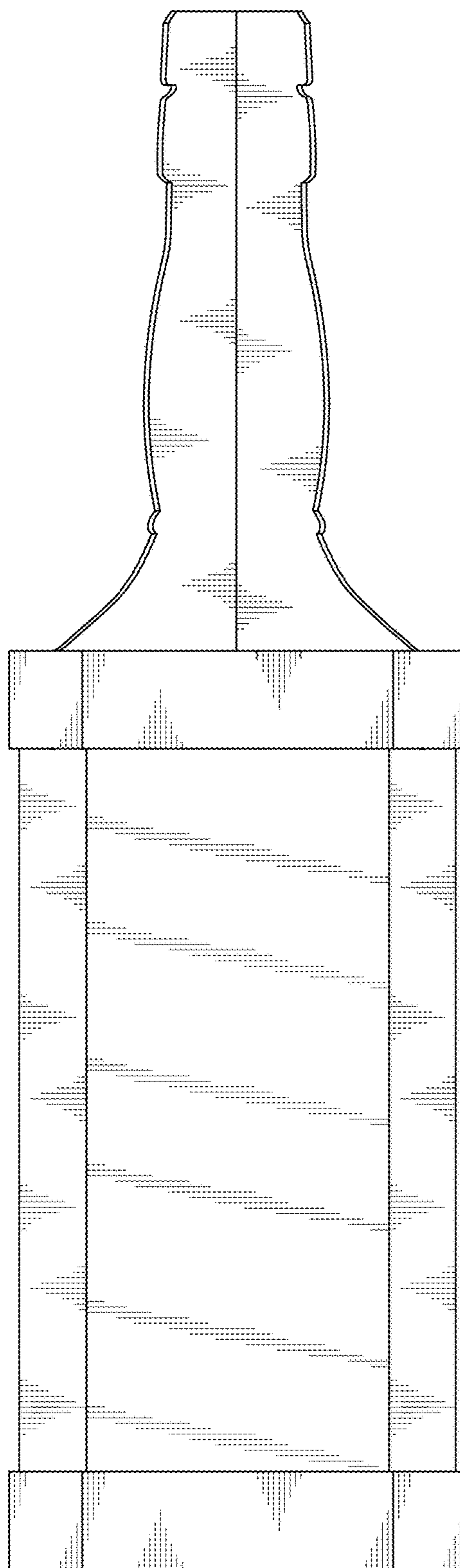

FIG. 7