



US00D831933S

(12) **United States Design Patent** (10) **Patent No.:** **US D831,933 S**
Hoshiba (45) **Date of Patent:** **** Oct. 30, 2018**

(54) **SPORTS PANTS**

- (71) Applicant: **Rawlings Sporting Goods Company, Inc.**, St. Louis, MO (US)
- (72) Inventor: **Mitsuyoshi Hoshiba**, Tokyo (JP)
- (73) Assignee: **Rawlings Sporting Goods Company, Inc.**, St. Louis, MO (US)

(**) Term: **15 Years**

(21) Appl. No.: **29/596,064**

(22) Filed: **Mar. 4, 2017**

(30) **Foreign Application Priority Data**

Sep. 5, 2016 (JP) 2016-018997
 Sep. 5, 2016 (JP) 2016-018998

(51) **LOC (11) Cl.** **02-02**

(52) **U.S. Cl.**
USPC **D2/731**

(58) **Field of Classification Search**
 USPC D2/731, 738, 742, 743, 746, 747, 748
 CPC A41B 11/00; A41D 13/00; A41D 13/06;
 A44B 1/30
 See application file for complete search history.

(56) **References Cited**

U.S. PATENT DOCUMENTS

D264,765	S *	6/1982	Hattori	D2/742
4,987,613	A *	1/1991	Loverdi	A41D 1/08
					2/22
6,041,437	A *	3/2000	Barker	A41D 1/067
					156/278
D485,049	S *	1/2004	Newson	D2/742
D588,336	S *	3/2009	Fazeli	D2/742
D648,922	S *	11/2011	Evans	D2/742
D679,482	S *	4/2013	Fuerst	D2/742
D686,800	S *	7/2013	Kelly	D2/742
D787,159	S *	5/2017	Lago	D2/742
D788,408	S *	6/2017	Lago	D2/742
2006/0156518	A1 *	7/2006	Frank	A44B 1/08
					24/104

(Continued)

OTHER PUBLICATIONS

“Easton Pro Knicker Piped Baseball Pants”. Found online Mar. 28, 2018 at www.eastbay.com. Page dated May 2, 2016. Retrieved from https://www.eastbay.com/product/model:258244/sku:1671064/easton-pro--knicker-piped-baseball-pants-boys-grade-school/white/navy/*

(Continued)

Primary Examiner — Manpreet S Matharu

Assistant Examiner — Jennifer M Campbell

(74) *Attorney, Agent, or Firm* — Husch Blackwell LLP

(57) **CLAIM**

The ornamental design for a “sports pants,” as shown and described.

DESCRIPTION

FIG. 1 is a front elevation view of the sports pants, showing my new design;
 FIG. 2 is a rear elevation view thereof;
 FIG. 3 is a top plan view thereof;
 FIG. 4 is a bottom plan view thereof;
 FIG. 5 is a right elevation view thereof;
 FIG. 6 is a left elevation view thereof;
 FIG. 7 is an enlarged top plan view thereof;
 FIG. 8 is a perspective view thereof;
 FIG. 9 is an enlarged right side view of the detail identified in FIG. 5; and,
 FIG. 10 is an enlarged front view showing the sports pants in an unzipped position.
 In FIGS. 5 and 9, the dash dot dash lines depict the outline of the enlarged view and form no part of the claimed design.
 In FIGS. 1 through 10, evenly-spaced broken lines depict portions of the sports pants that form no part of the claimed design.

1 Claim, 6 Drawing Sheets

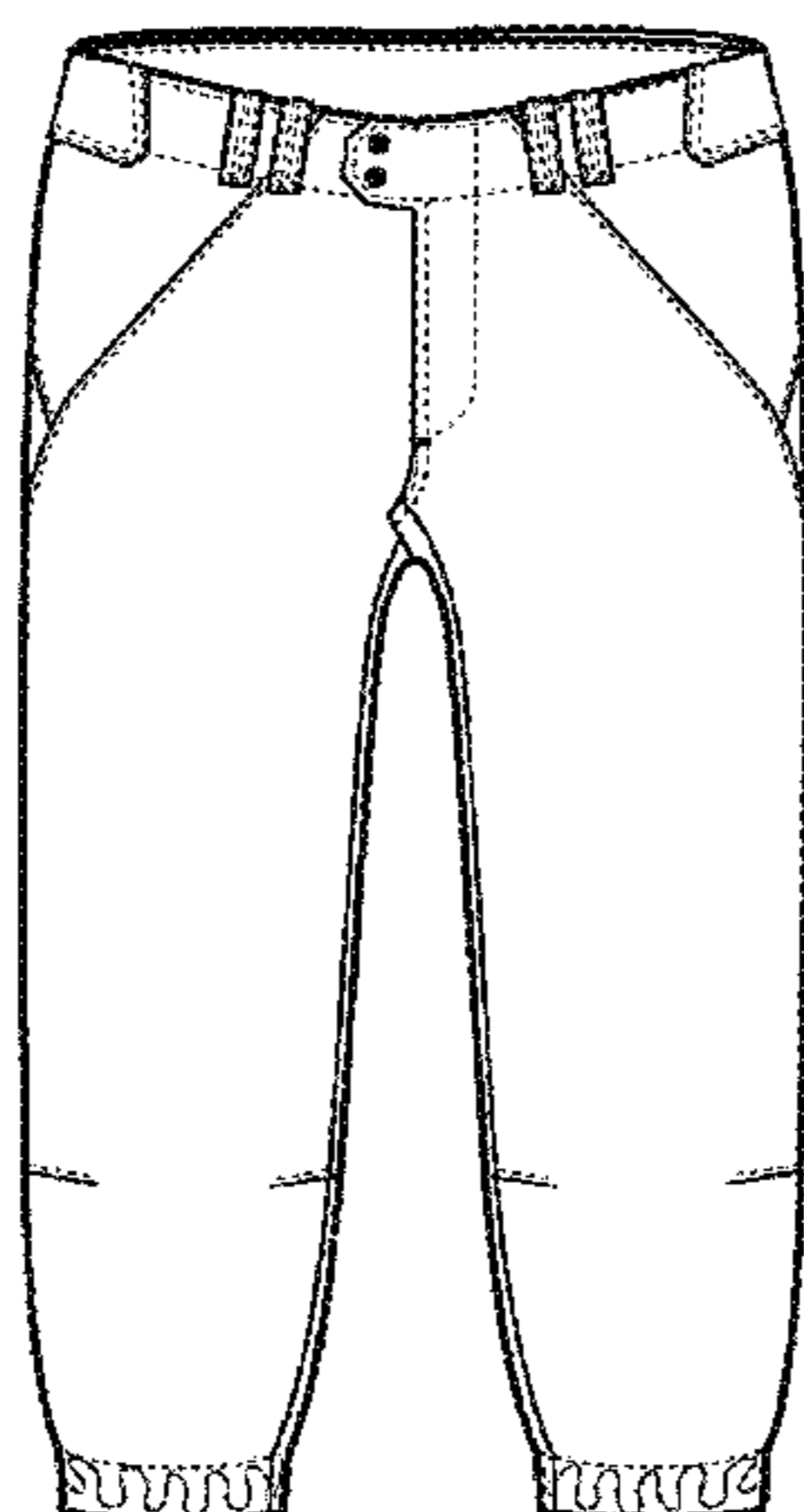

(56)

References Cited

U.S. PATENT DOCUMENTS

2015/0313302 A1* 11/2015 Boyle A41D 1/08
2/228
2015/0361597 A1* 12/2015 Candrian D03D 1/00
28/153
2016/0120246 A1* 5/2016 Boyle A41D 1/06
2/227
2017/0119065 A1* 5/2017 Boyle A41D 27/204
2017/0181483 A1* 6/2017 Eisenhuth A41D 1/06
2017/0303605 A1* 10/2017 Barasa A41D 1/08

OTHER PUBLICATIONS

“Rawlings Adult Premier Straight Baseball Pant”. Found online
Mar. 28, 2018 at www.rawlings.com. Page dated n/a. Retrieved
from <https://www.rawlings.com/product/P-PPU140A.html>.*

* cited by examiner

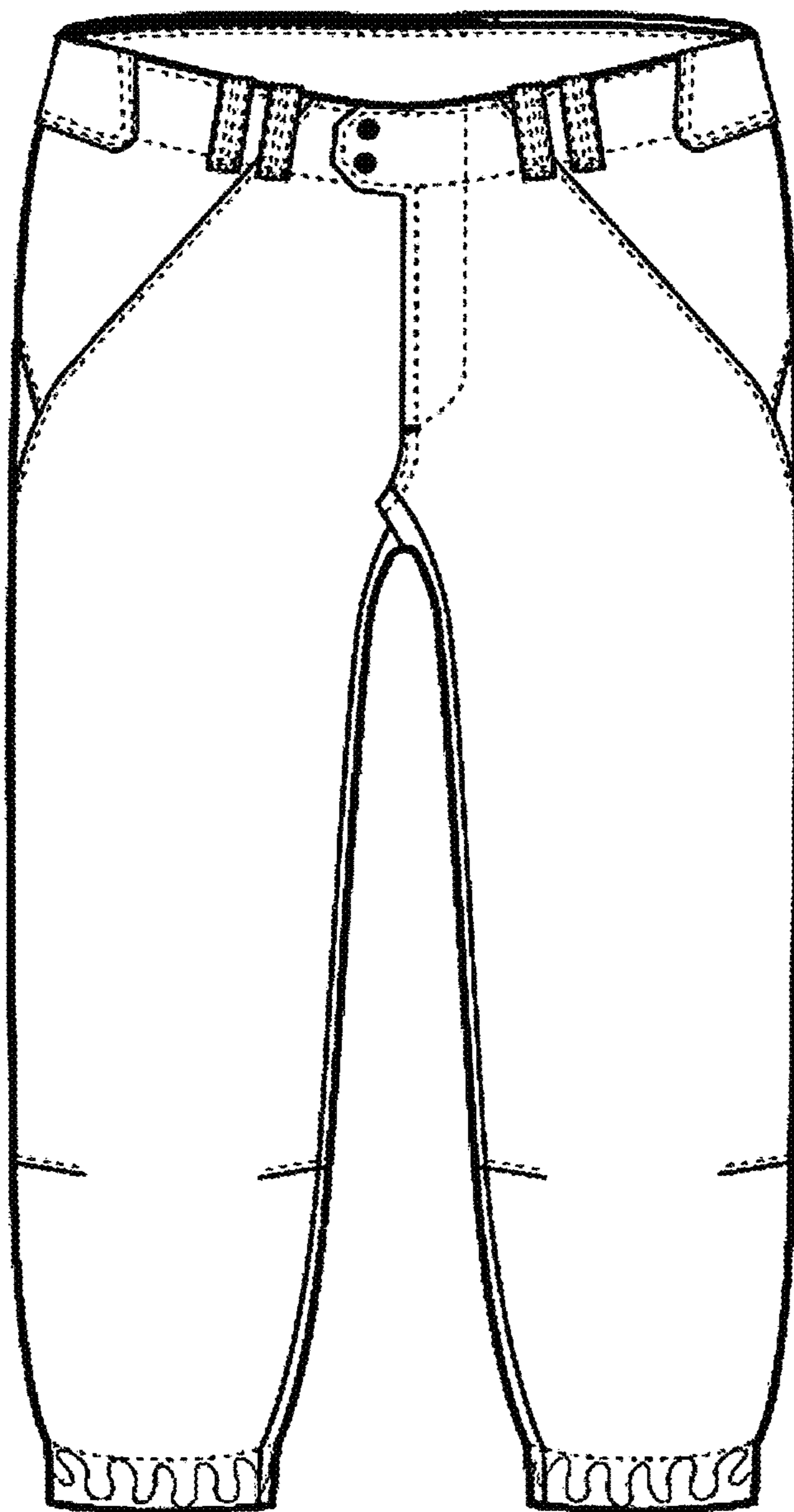

FIG. 1

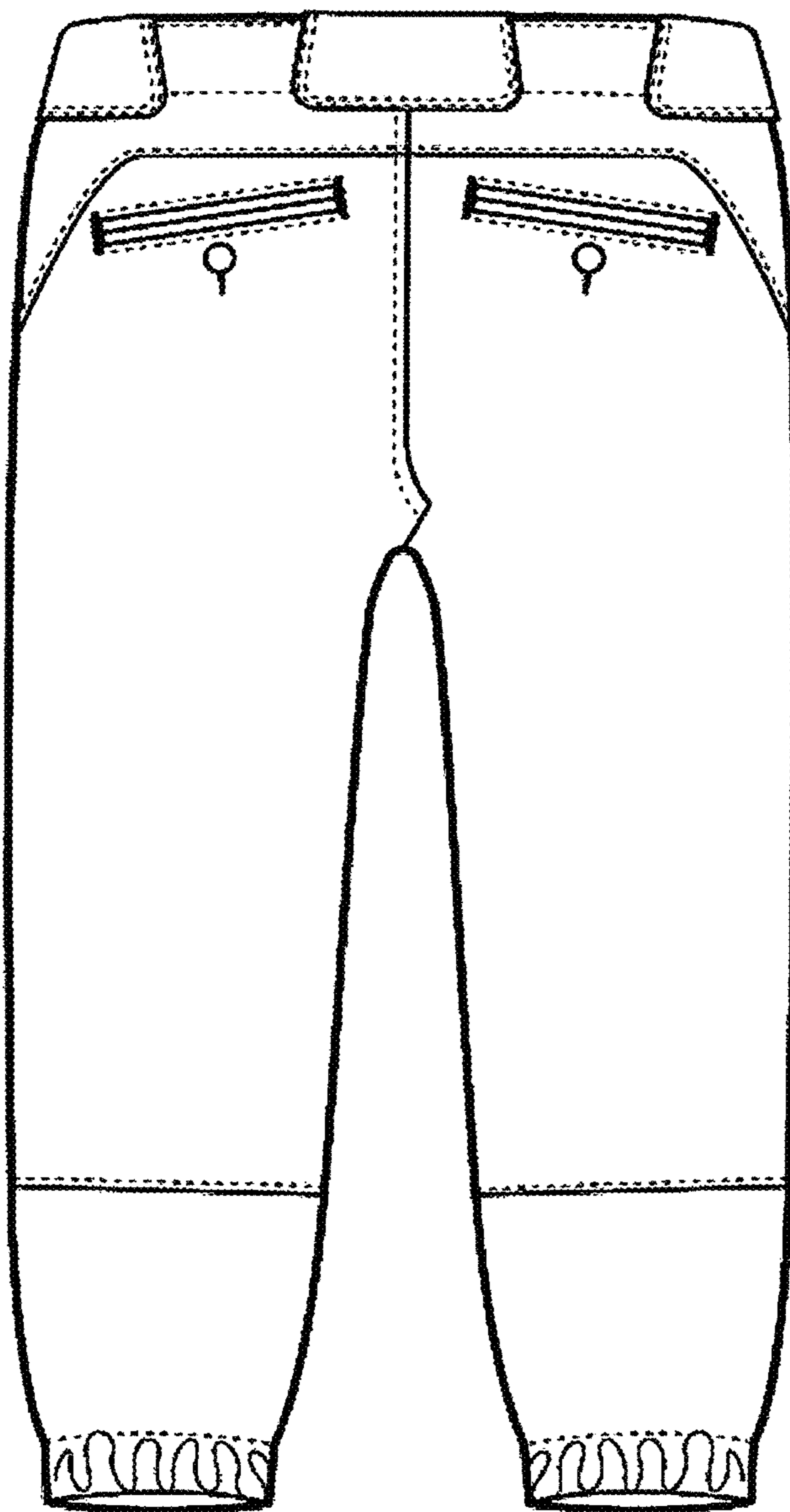

FIG. 2

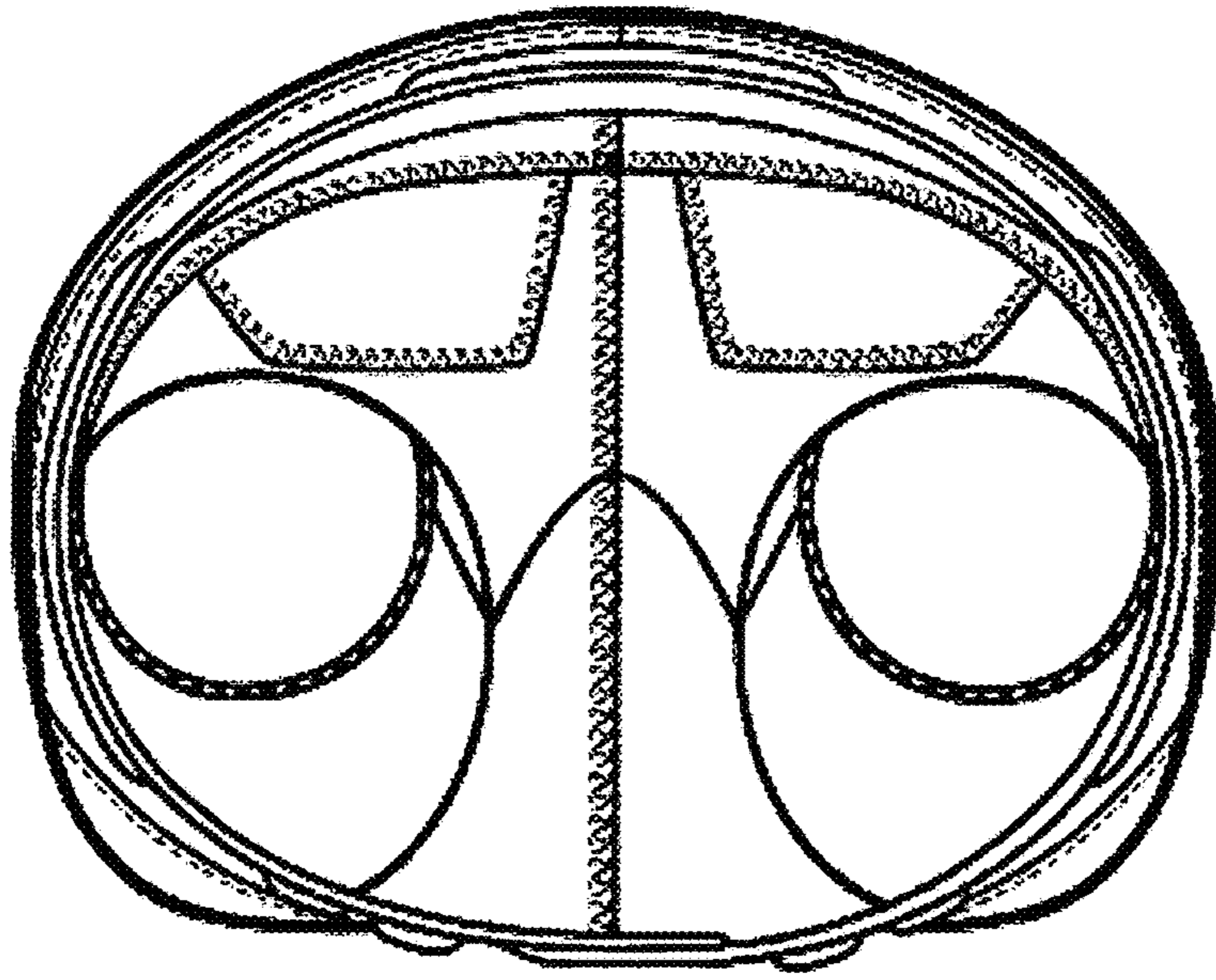

FIG. 3

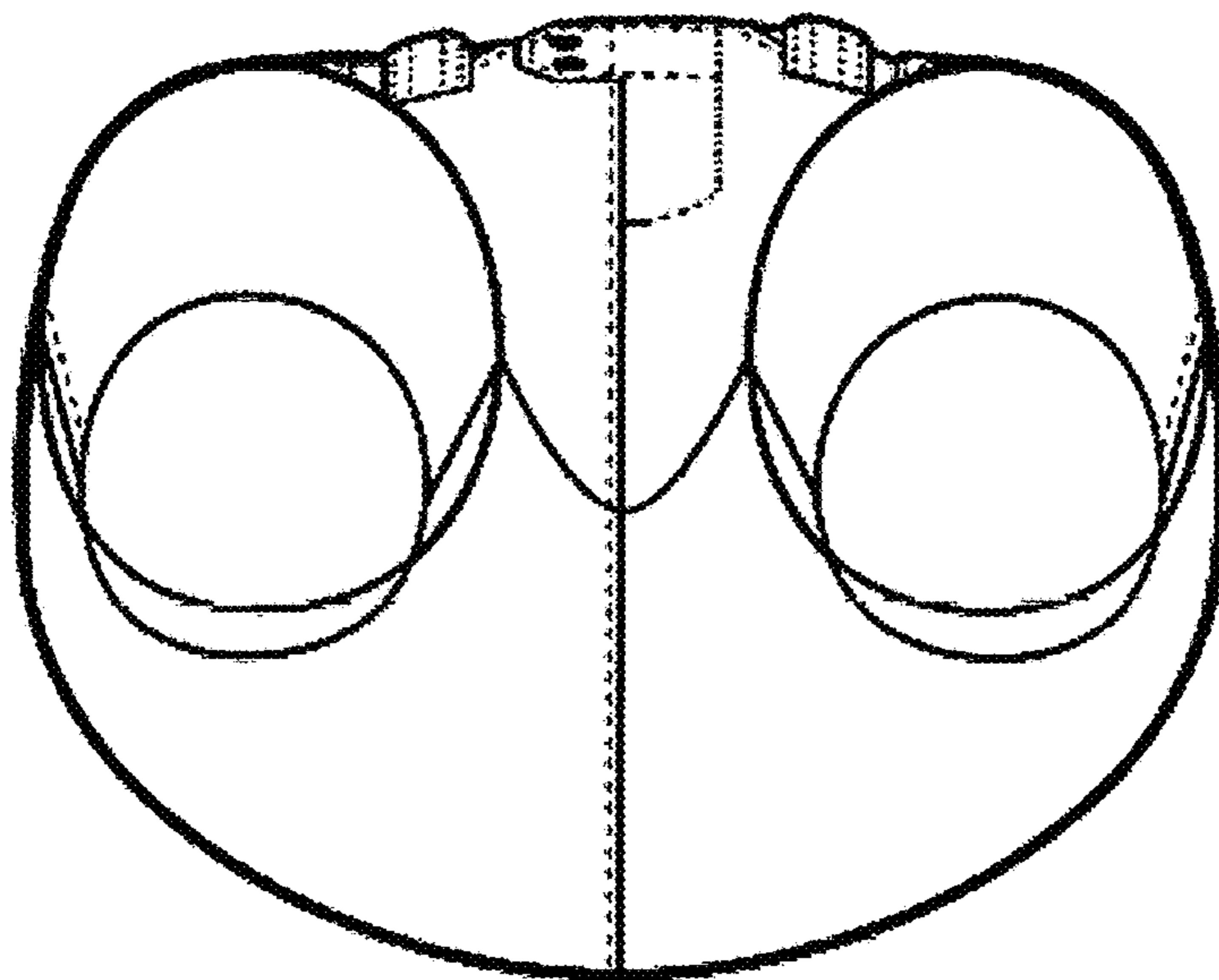

FIG. 4

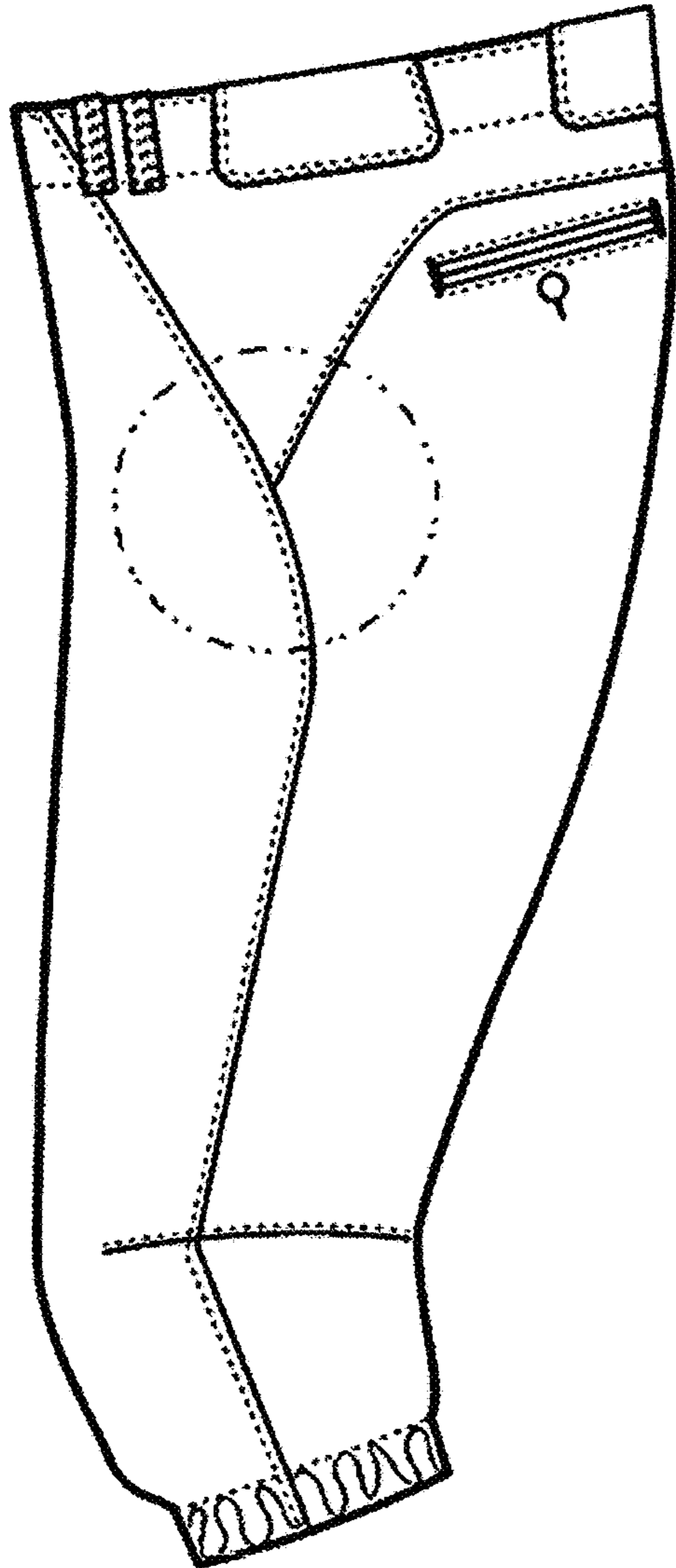

FIG. 5

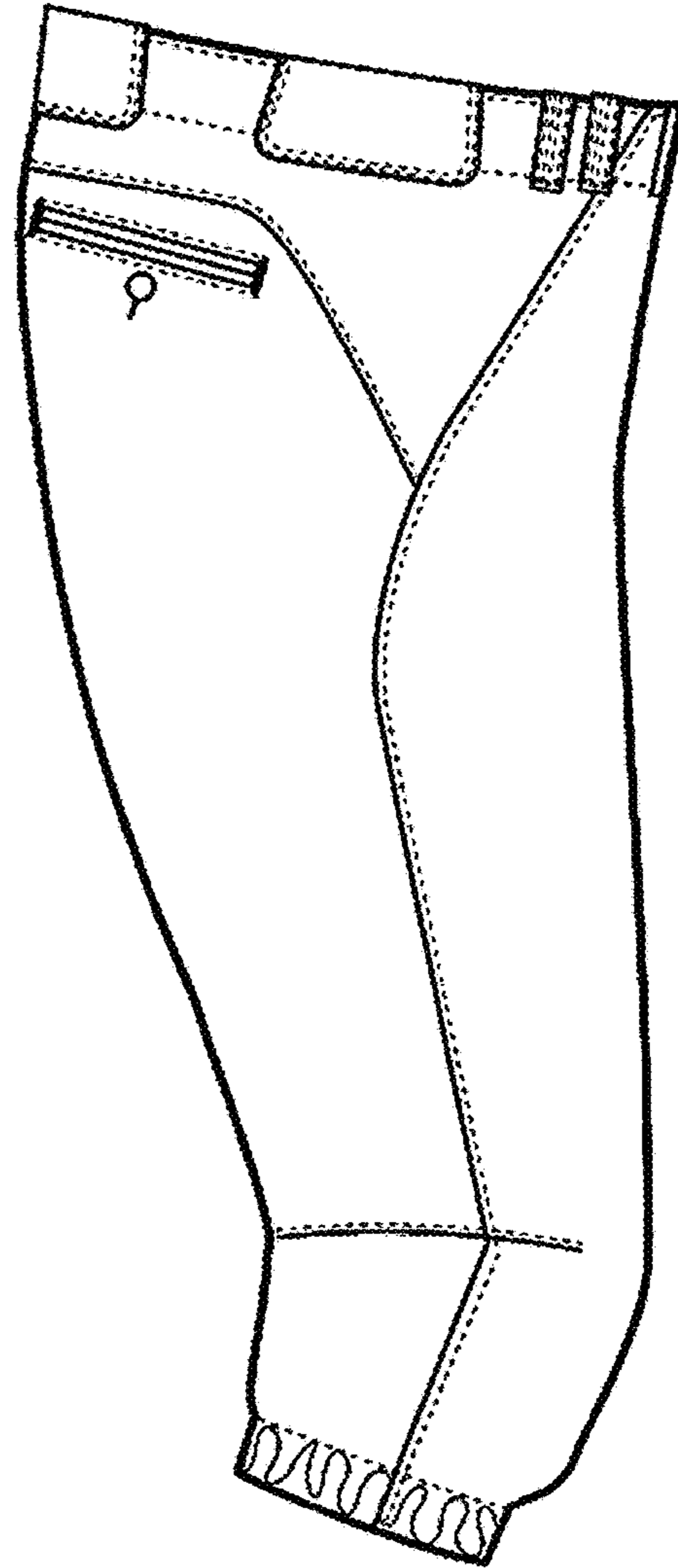

FIG. 6

FIG. 7

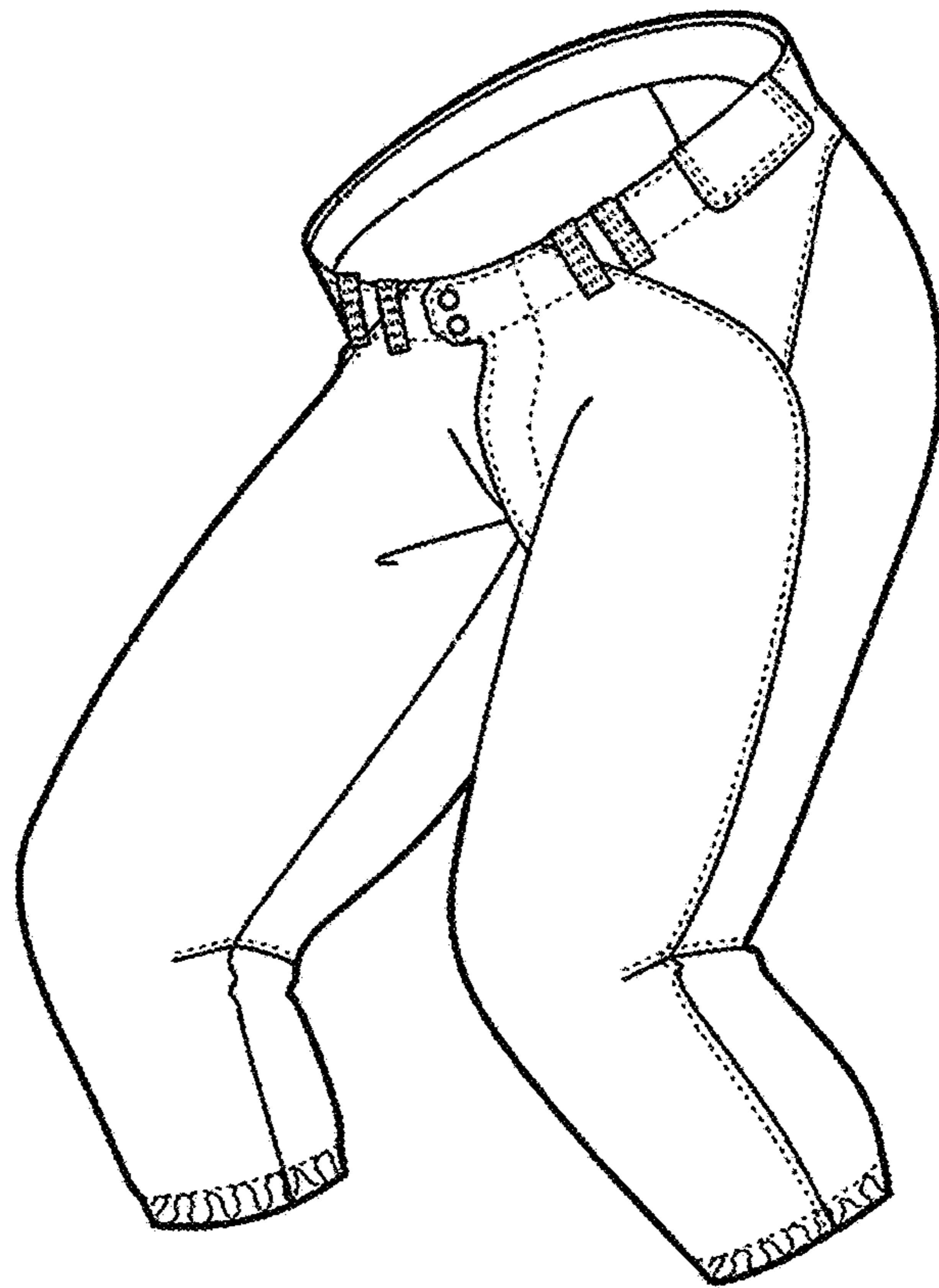
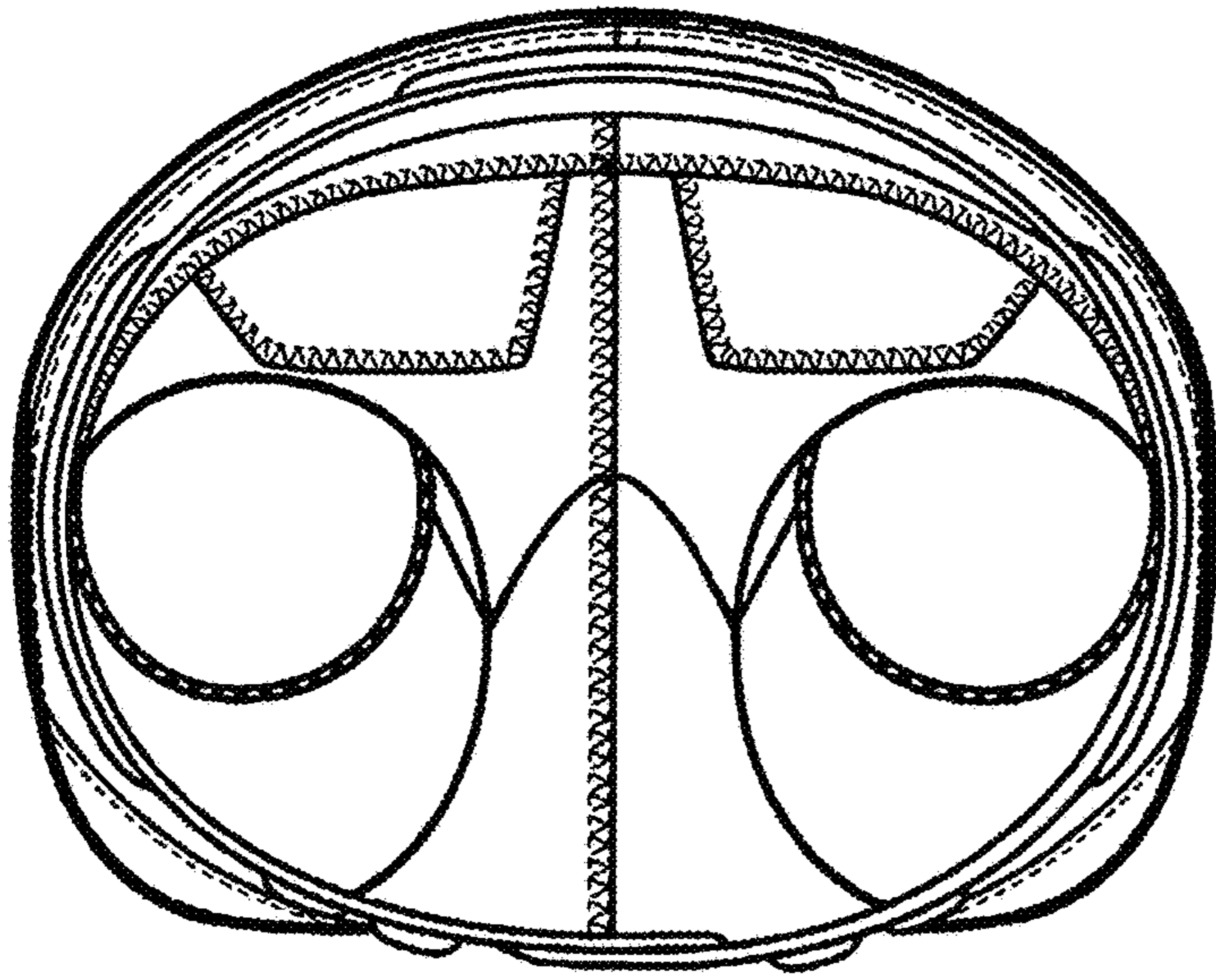

FIG. 8

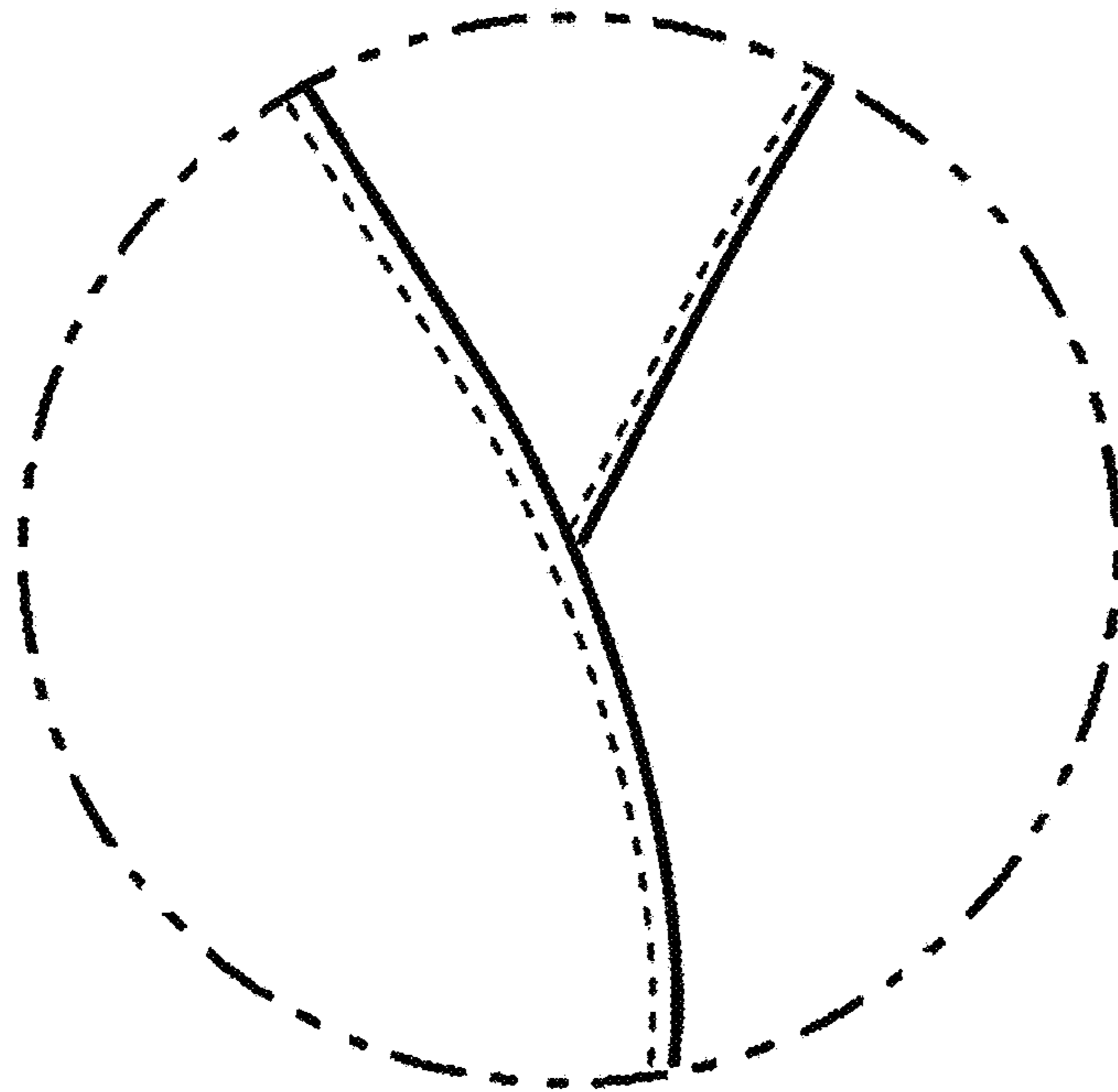

FIG. 9

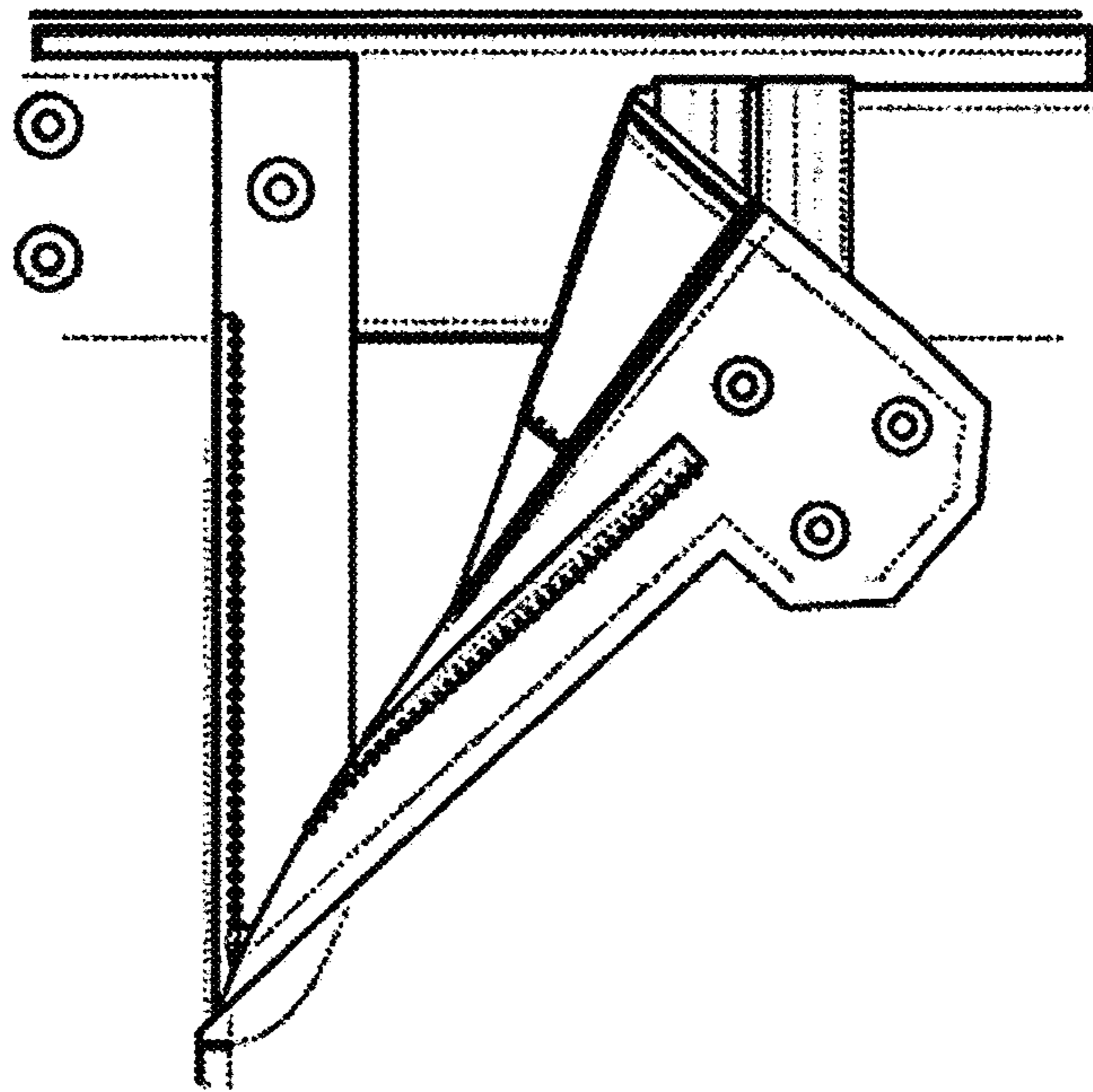

FIG. 10