



US00D831914S

(12) **United States Design Patent** (10) **Patent No.:** **US D831,914 S**  
**Ha et al.** (45) **Date of Patent:** **\*\* \*Oct. 23, 2018**

(54) **DOOR FOR WASHING MACHINE**

(56) **References Cited**

(71) Applicant: **LG ELECTRONICS INC.**, Seoul (KR)

U.S. PATENT DOCUMENTS

(72) Inventors: **Youngsoo Ha**, Seoul (KR); **Taewoo Yoo**, Seoul (KR); **Eunyoung Chee**, Seoul (KR); **Jeaseok Seong**, Seoul (KR)

D428,222	S	*	7/2000	Tunzi	.....	D32/25
D434,536	S	*	11/2000	Schober	.....	D32/25
D617,512	S	*	6/2010	DeSalvo	.....	D32/25
D618,871	S	*	6/2010	DeSalvo	.....	D32/25
D620,212	S	*	7/2010	Bixby	.....	D32/25
D646,859	S	*	10/2011	DeSalvo	.....	D32/25
D648,909	S	*	11/2011	Bhattacharya	.....	D32/25
D651,778	S	*	1/2012	Miller	.....	D32/25
D699,906	S	*	2/2014	Choi	.....	D32/25
D714,502	S	*	9/2014	Jeon	.....	D32/25
D746,006	S	*	12/2015	Ha	.....	D32/25
D755,457	S	*	5/2016	Chung	.....	D32/25
D758,028	S	*	5/2016	Bixby	.....	D32/25
D758,032	S	*	5/2016	Bixby	.....	D32/25
D759,326	S	*	6/2016	Jeon	.....	D32/25
D759,915	S	*	6/2016	Choi	.....	D32/25
D760,456	S	*	6/2016	Jeon	.....	D32/25
D761,506	S	*	7/2016	Choi	.....	D32/25

(73) Assignee: **LG ELECTRONICS INC.**, Seoul (KR)

(\*) Notice: This patent is subject to a terminal disclaimer.

(\*\*) Term: **15 Years**

(21) Appl. No.: **35/502,559**

(22) Filed: **Sep. 6, 2016**

(80) **Hague Agreement Data**

Int. Filing Date: **Sep. 6, 2016**  
Int. Reg. No.: **DM/092455**  
Int. Reg. Date: **Sep. 6, 2016**  
Int. Reg. Pub. Date: **Mar. 10, 2017**

(30) **Foreign Application Priority Data**

Mar. 16, 2016 (KR) ..... 30-2016-0012173

(51) **LOC (11) Cl.** ..... **15-05**

(52) **U.S. Cl.**  
USPC ..... **D32/25**

(58) **Field of Classification Search**  
USPC ..... D32/1, 5, 6, 8, 10, 25, 28  
CPC ..... D06F 3/02; D06F 2204/065; D06F 25/00;  
D06F 35/006; D06F 37/28; D06F 39/14;  
D06F 58/00; D06F 58/02; D06F 58/04;  
D06F 58/20; D06F 23/04; G05B 19/042

See application file for complete search history.

(Continued)

*Primary Examiner* — Darlington Ly

(74) *Attorney, Agent, or Firm* — Birch, Stewart, Kolasch & Birch, LLP

(57) **CLAIM**

The ornamental design for a door for washing machine, as shown and described.

**DESCRIPTION**

1. Door for washing machine  
1.1 is a top, front, and left side perspective view of a door for washing machine showing our new design;  
1.2 is a front elevation view thereof;  
1.3 is a rear elevation view thereof;  
1.4 is a left side elevation view thereof;  
1.5 is a right side elevation view thereof;  
1.6 is a top plan view thereof; and  
1.7 is a bottom plan view thereof.  
The broken lines in the reproductions illustrate portions of the door for washing machine that form no part of the claimed design.

**1 Claim, 7 Drawing Sheets**

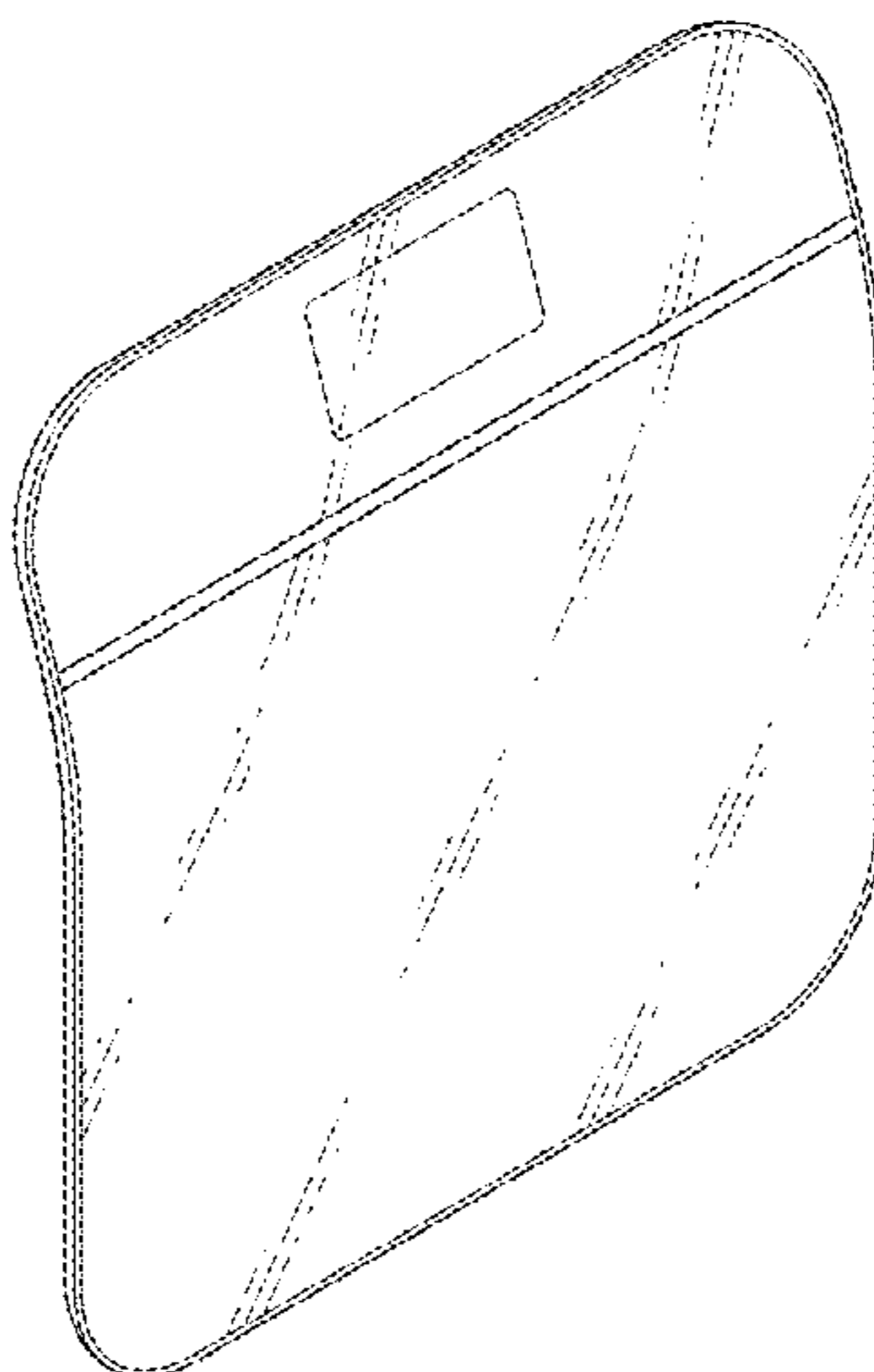

(56)

**References Cited**

U.S. PATENT DOCUMENTS

D767,835 S \* 9/2016 Ha ..... D32/25  
D772,507 S \* 11/2016 Bixby ..... D32/25  
2003/0046964 A1\* 3/2003 Bollmann ..... D06F 37/28  
68/139

\* cited by examiner

1.1

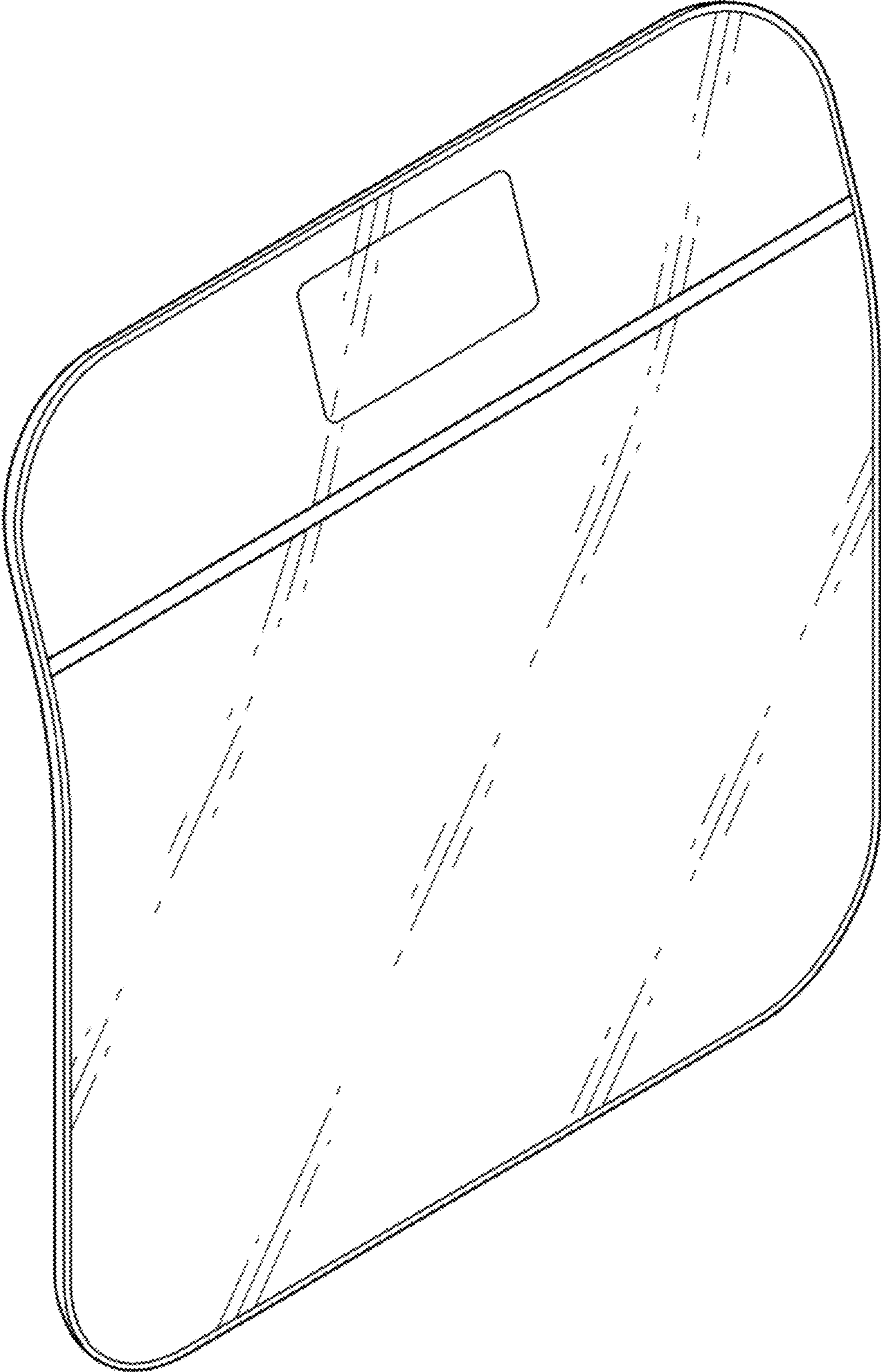

1.2

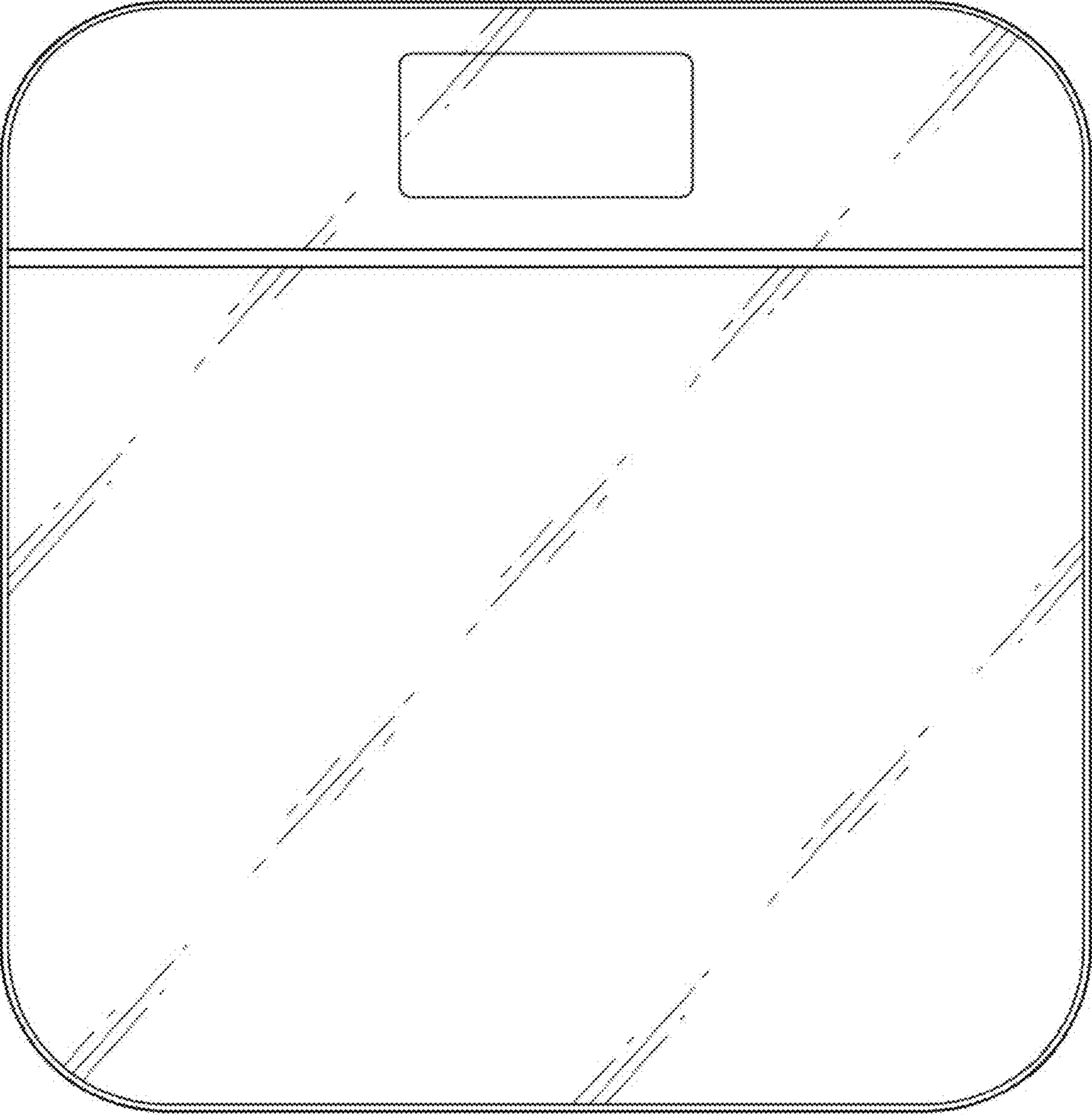

1.3

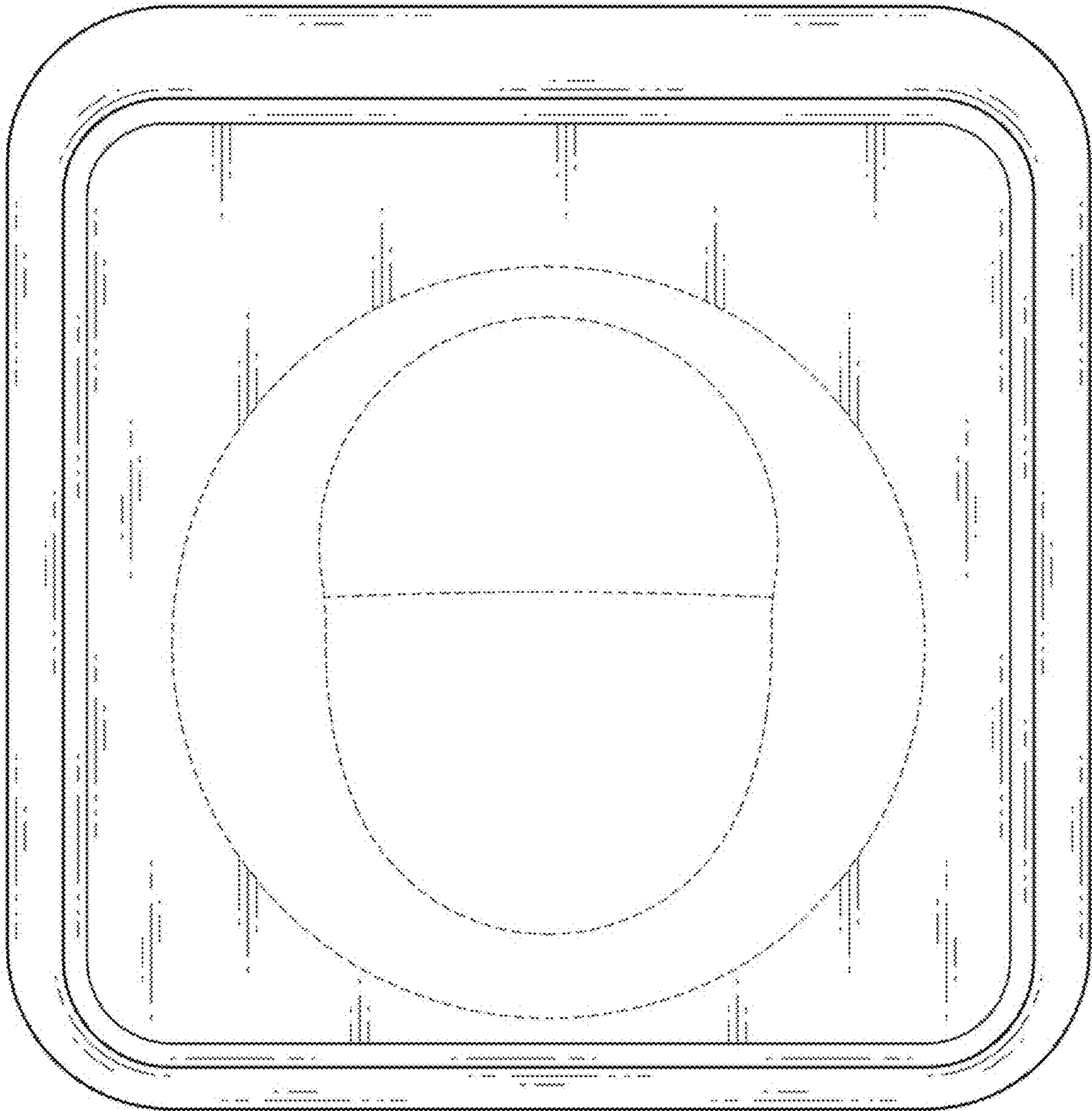

1.4

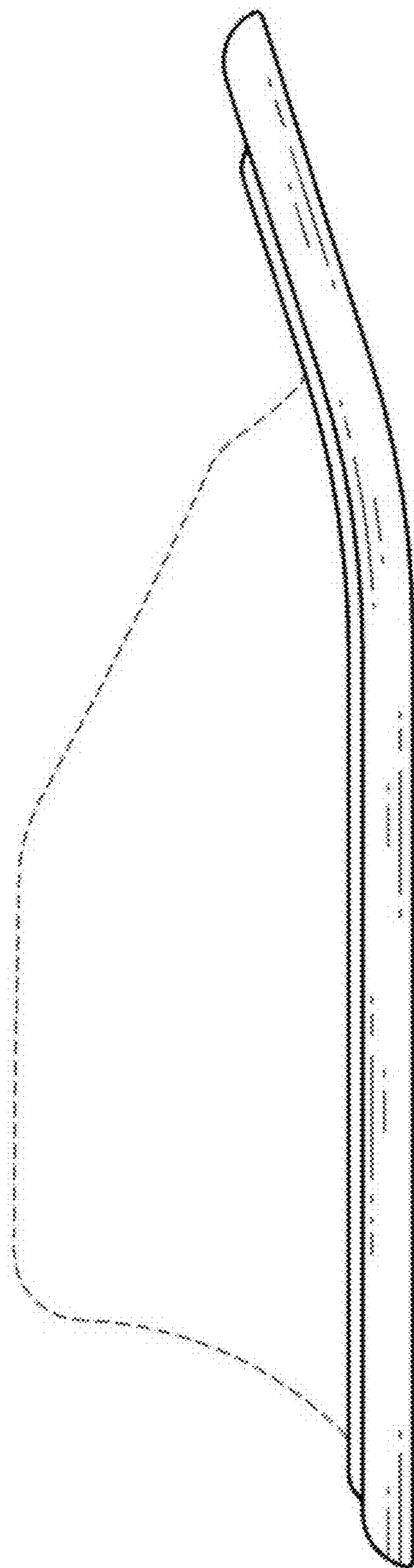

1.5

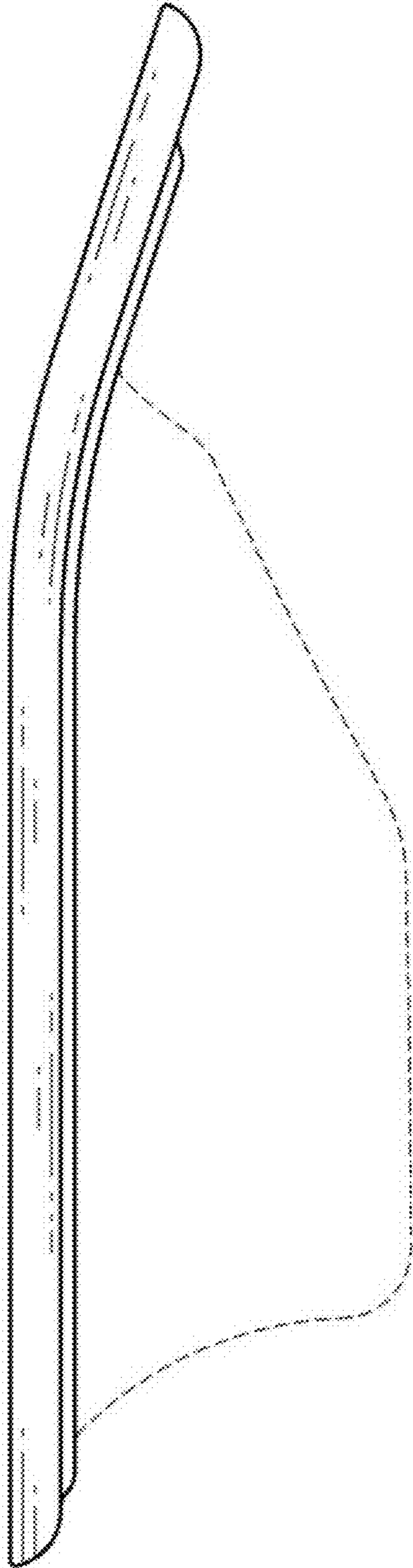

1.6

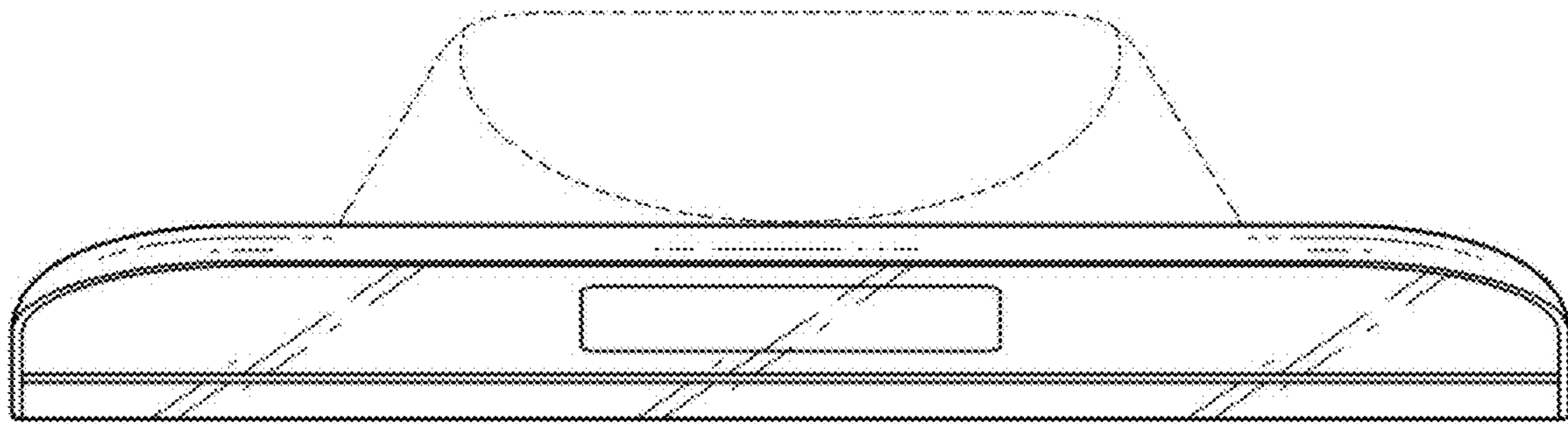



1.7

