



US00D831911S

(12) **United States Design Patent**
Joo et al.

(10) **Patent No.:** **US D831,911 S**
(45) **Date of Patent:** **** Oct. 23, 2018**

(54) **WASHBOARD FOR WASHING MACHINE**

(71) Applicant: **SAMSUNG ELECTRONICS CO., LTD.**, Suwon-si, Gyeonggi-do (KR)

(72) Inventors: **Ahjung Joo**, Seoul (KR); **Jungeun Park**, Seoul (KR)

(73) Assignee: **SAMSUNG ELECTRONICS CO., LTD.**, Gyeonggi-Do (KR)

3,664,160 A	5/1972	Muniz
D235,001 S	4/1975	Sunday
D235,002 S	4/1975	Sunday
D237,448 S	11/1975	Sunday
D254,230 S	2/1980	Sanger
D259,993 S	7/1981	Kunze
4,756,439 A	7/1988	Perock
6,169,237 B1	1/2001	Sanders
D729,484 S	5/2015	Arvinte et al.
9,340,915 B2	5/2016	Kim et al.
D759,929 S	6/2016	Lee

(Continued)

(**) Term: **15 Years**

(21) Appl. No.: **29/628,101**

(22) Filed: **Dec. 1, 2017**

Related U.S. Application Data

(63) Continuation of application No. 29/536,428, filed on Aug. 17, 2015, now Pat. No. Des. 807,606.

(51) **LOC (11) Cl.** **15-05**

(52) **U.S. Cl.**
USPC **D32/25**

(58) **Field of Classification Search**
USPC D32/1, 6, 10, 25, 28, 53, 53.1, 54, 67
CPC D06F 3/00; D06F 3/02; D06F 1/04; D06F 31/00; D06F 37/065; D06F 37/18; D06F 37/267; D06F 39/14; G10D 13/06
See application file for complete search history.

(56) **References Cited**

U.S. PATENT DOCUMENTS

1,556,481 A	10/1925	Amour
1,592,103 A	7/1926	Gunuskey
1,814,698 A	7/1931	Huber
2,129,079 A	9/1938	Adams
D153,319 S	4/1949	Rabinowitz
2,504,819 A	4/1950	Flores
2,704,448 A	3/1955	Petit
D189,496 S	12/1960	Kinyon
D193,208 S	7/1962	Graham

FOREIGN PATENT DOCUMENTS

KR	2020130001857 U	3/2013
WO	2015130015 A1	9/2015

Primary Examiner — Rosemary K Tarcza

Assistant Examiner — Yolanda Robinson

(74) *Attorney, Agent, or Firm* — Cantor Colburn LLP

(57) **CLAIM**

The ornamental design for a washboard for washing machine, as shown and described.

DESCRIPTION

FIG. 1 is a perspective view of a washboard for washing machine, showing our new design;
FIG. 2 is a front view thereof;
FIG. 3 is a rear view thereof;
FIG. 4 is a side view thereof;
FIG. 5 is another side view thereof;
FIG. 6 is a top view thereof;
FIG. 7 is a bottom view thereof; and,
FIG. 8 is an enlarged view of the encircled portion 8 thereof in FIG. 1.

The broken lines illustrating portions of the washboard for washing machine form no part of the claimed design. The dash-dot broken lines surrounding the enlarged portion form no part of the claimed design.

1 Claim, 8 Drawing Sheets

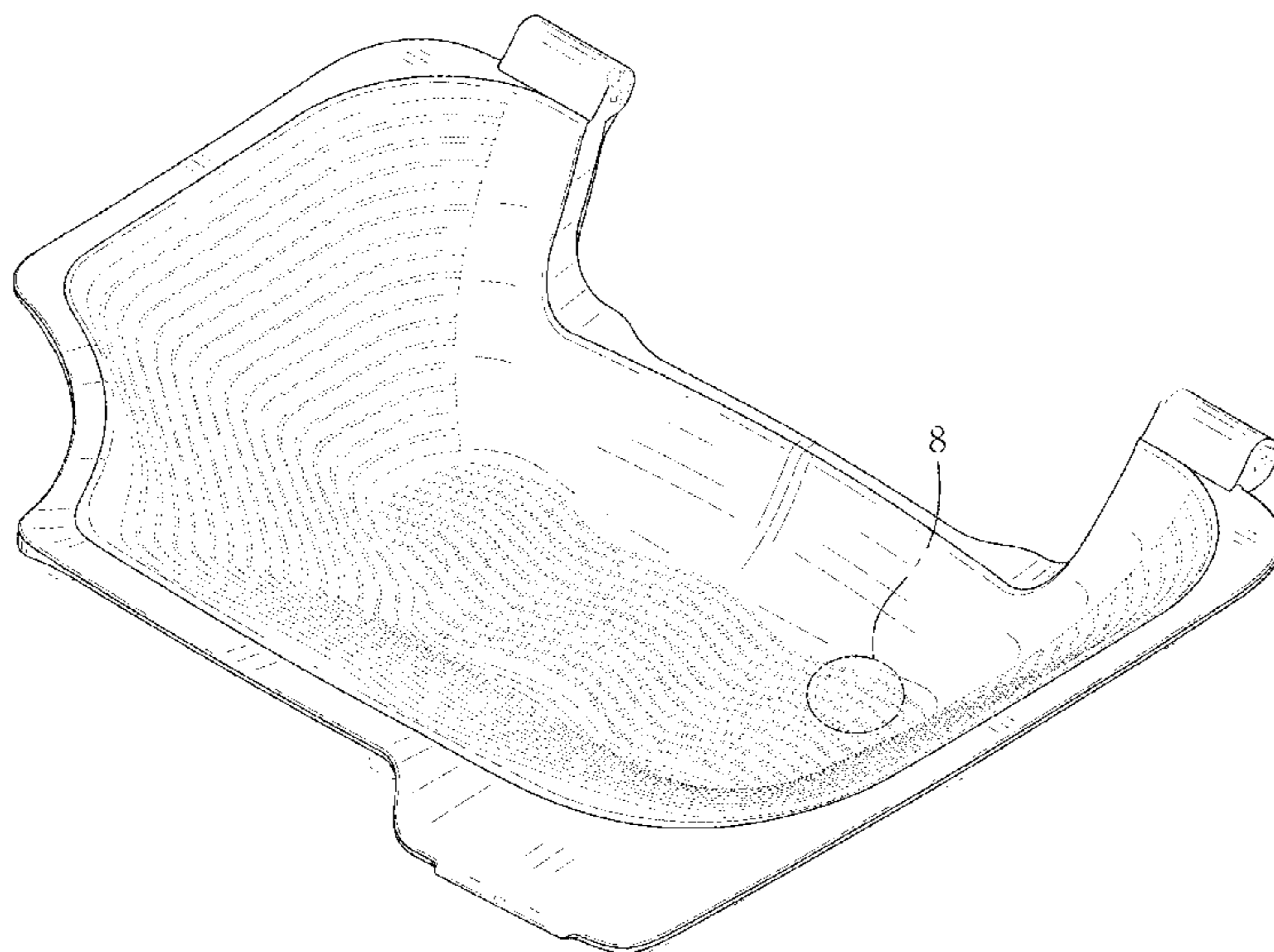

(56)

References Cited

U.S. PATENT DOCUMENTS

D759,930	S	6/2016	Kang et al.	
D759,931	S *	6/2016	Lee	D32/25
D759,932	S	6/2016	Lee	
D759,933	S *	6/2016	Lee	D32/25
D760,967	S *	7/2016	Joo	D32/6
D760,987	S *	7/2016	Kang	D32/25
D761,502	S *	7/2016	Joo	D32/6
D775,441	S *	12/2016	Joo	D32/25
D785,890	S *	5/2017	Jang	D32/67
D807,606	S *	1/2018	Joo	D32/67
D813,476	S *	3/2018	Lee	D32/25
2016/0230326	A1 *	8/2016	Han	D06F 31/00
2018/0080159	A1 *	3/2018	Kim	D06F 39/003

* cited by examiner

FIG. 1

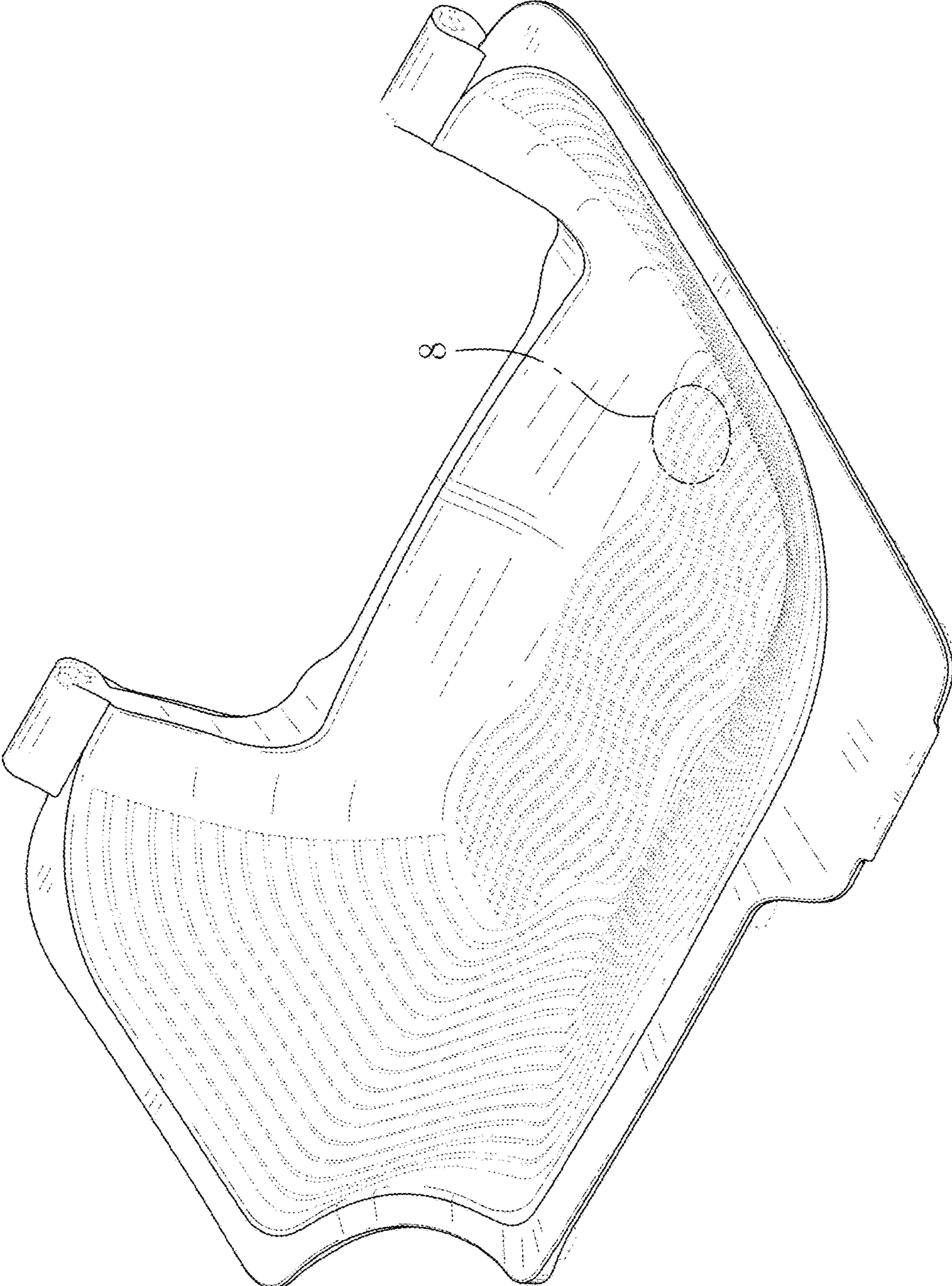

FIG. 2

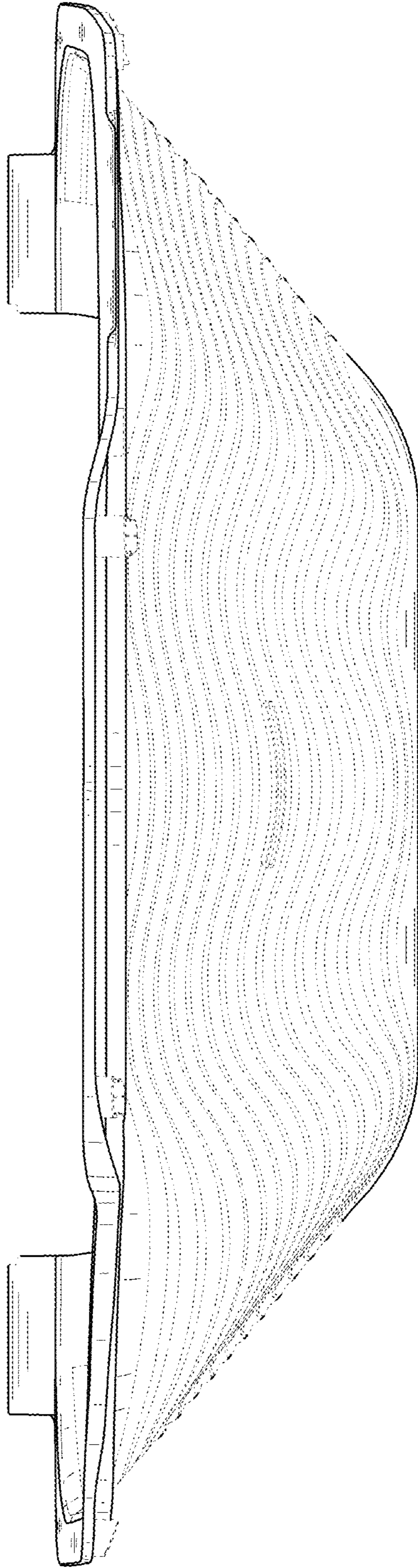

FIG. 3

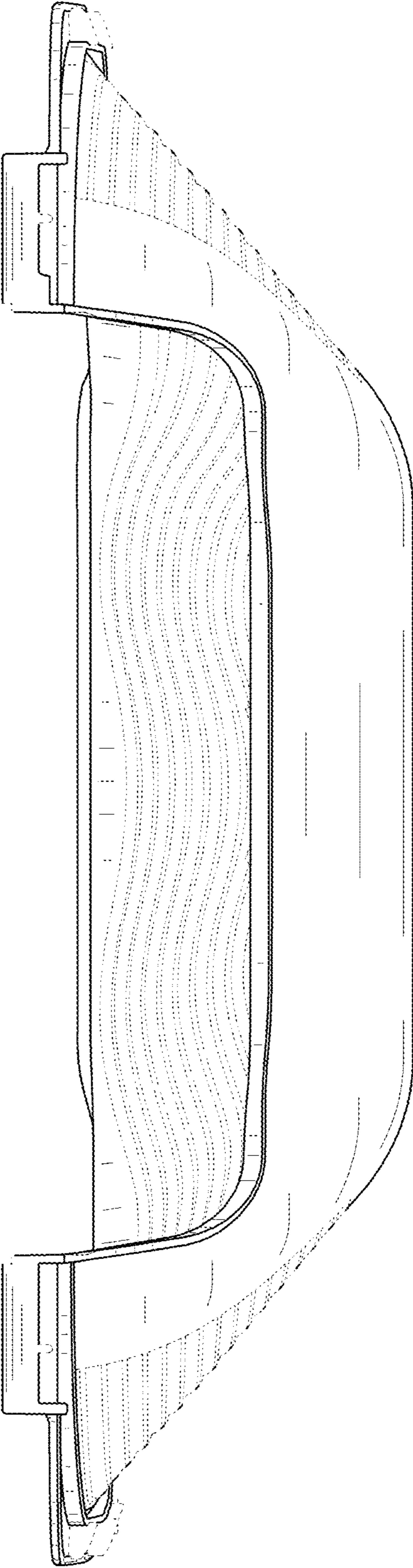

FIG. 4

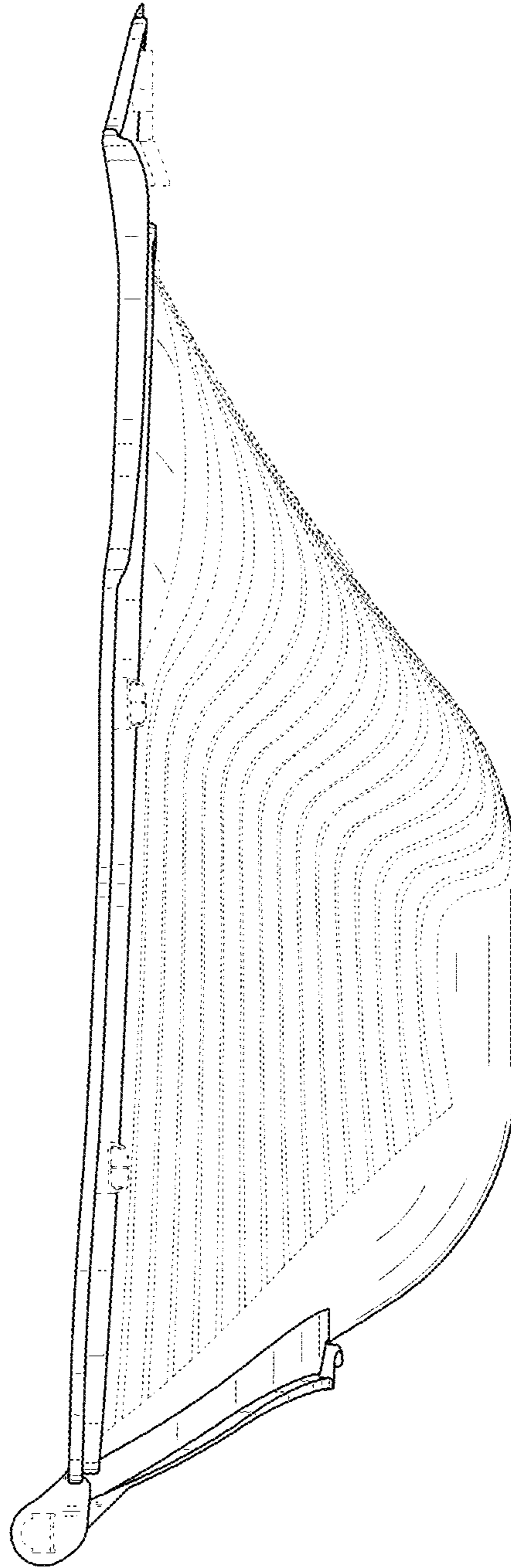

FIG. 5

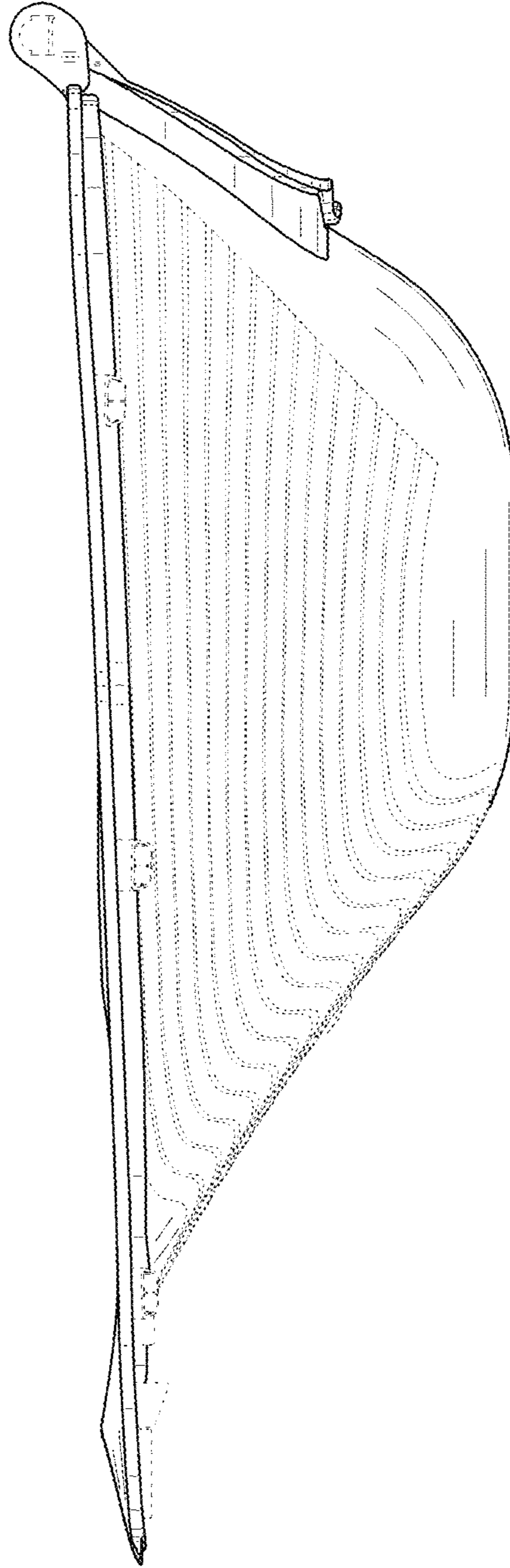

FIG. 6

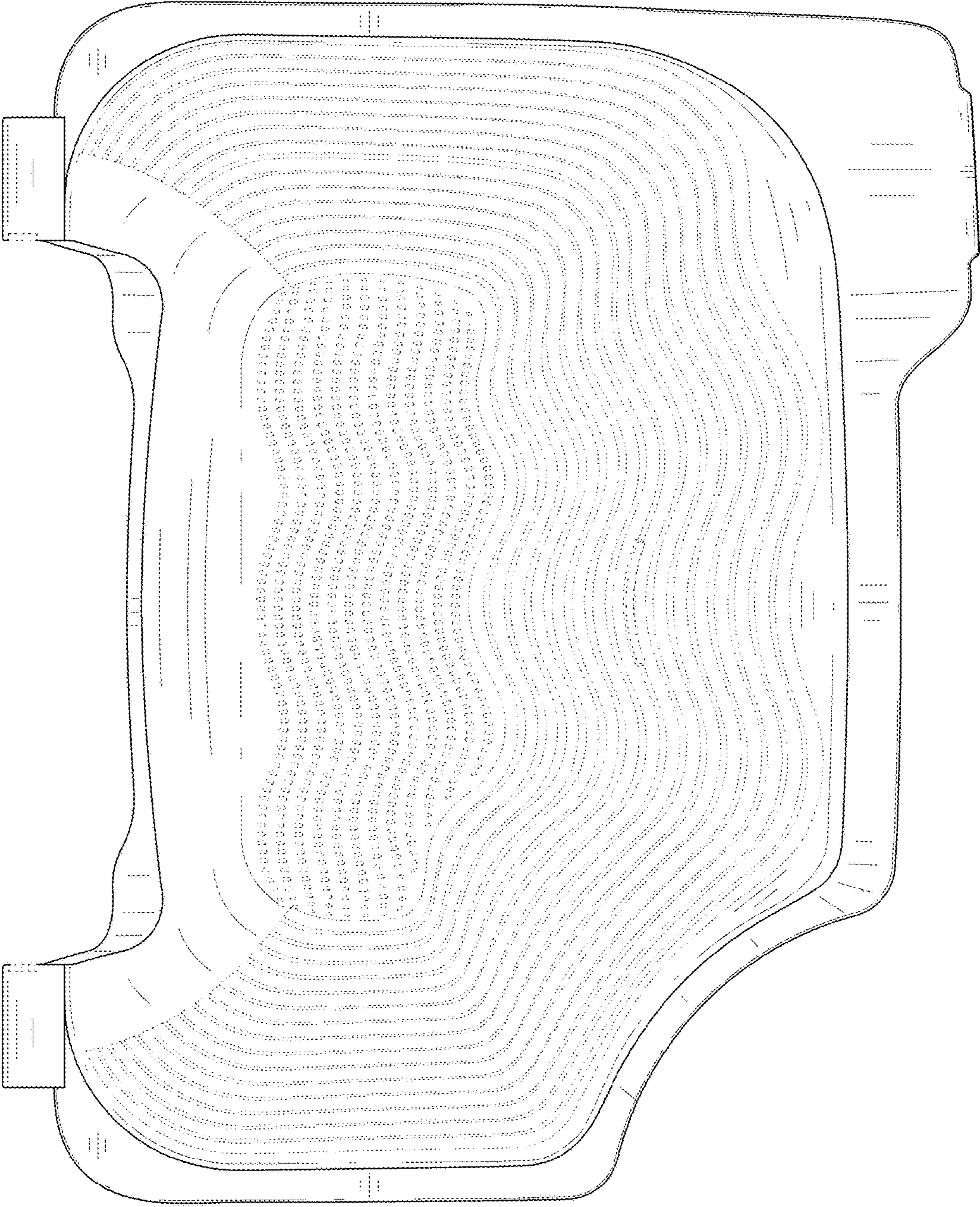

FIG. 7

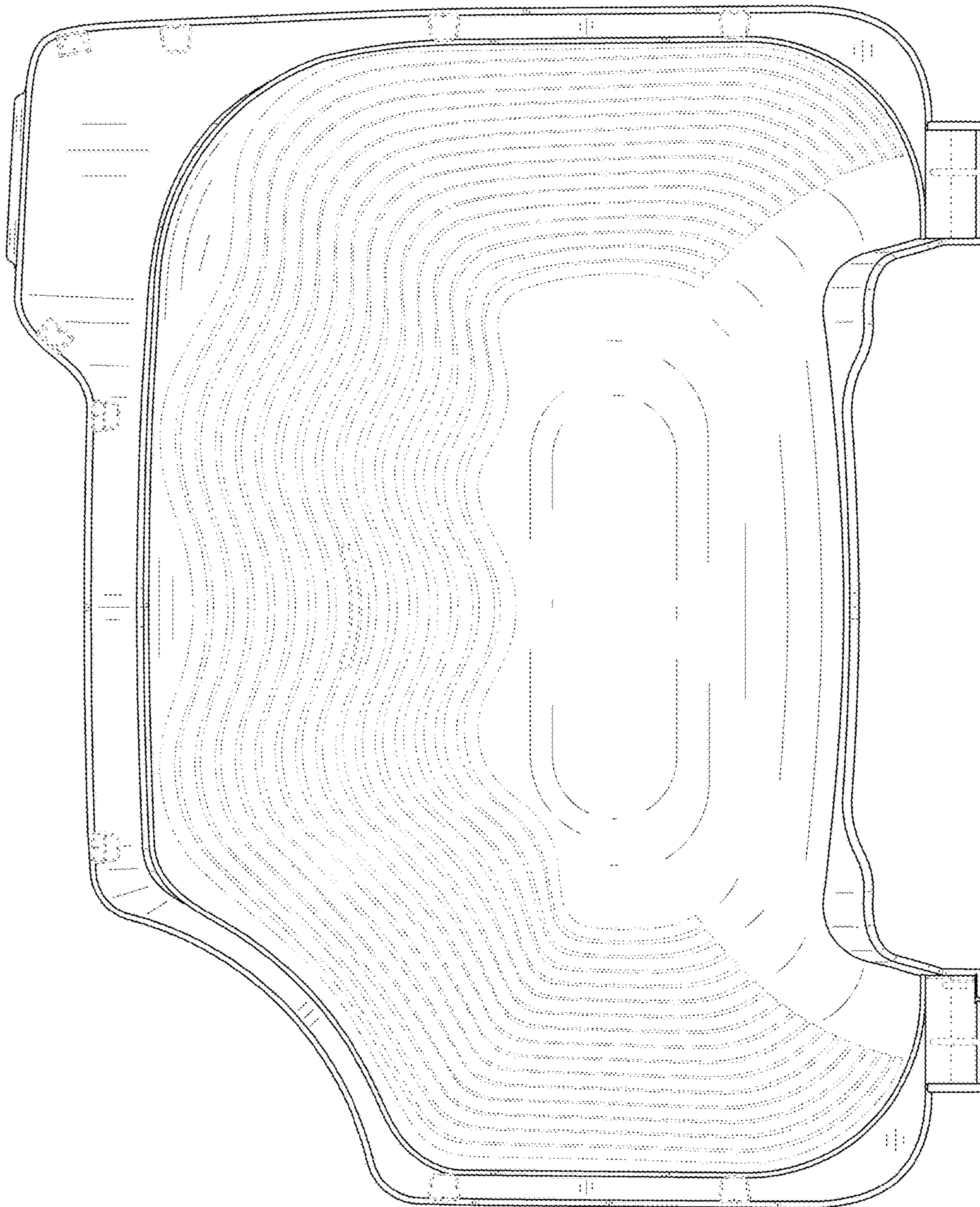

FIG. 8

