



US00D831896S

(12) **United States Design Patent** (10) **Patent No.:** **US D831,896 S**
Krahe (45) **Date of Patent:** **** Oct. 23, 2018**

(54) **FINGER MITT**

(71) Applicant: **Meah Krahe**, Chicago, IL (US)

(72) Inventor: **Meah Krahe**, Chicago, IL (US)

(**) Term: **15 Years**

(21) Appl. No.: **29/605,974**

(22) Filed: **May 31, 2017**

(51) **LOC (11) Cl.** **02-06**

(52) **U.S. Cl.**
USPC **D29/114**

(58) **Field of Classification Search**
USPC D29/100, 113, 114, 115, 116.2; D2/617
CPC A41D 13/087; A41D 19/01
See application file for complete search history.

(56) **References Cited**

U.S. PATENT DOCUMENTS

1,955,989 A * 4/1934 Uhri A41D 13/082
15/209.1
1,990,553 A * 2/1935 Hirsch A41D 13/087
15/227
2,069,449 A * 2/1937 Jensen A61F 13/105
15/227
3,407,927 A * 10/1968 Jones A47G 21/001
206/372
D425,261 S * 5/2000 Basile D29/118
D477,690 S * 7/2003 Howell D29/118
D504,544 S * 4/2005 Lee D29/118
D506,291 S * 6/2005 Lee D29/118
7,117,536 B2 * 10/2006 Burnett A41D 13/087
2/16
7,165,270 B2 * 1/2007 DeYoung A41D 13/087
2/16
D547,010 S * 7/2007 Shamoan D29/118
D558,929 S * 1/2008 Bleakney D29/114
D561,948 S * 2/2008 Stewart A41D 13/081
D29/118
D575,460 S * 8/2008 Patel D29/118

D580,215 S * 11/2008 McCarthy D7/368
D634,898 S * 3/2011 Lion D29/119
D652,994 S * 1/2012 Shamoan D29/118
D701,008 S * 3/2014 Fanelli D2/623
8,918,943 B2 * 12/2014 Blaszczec A46B 5/0012
15/160
D724,272 S * 3/2015 Nielson D29/118
D724,790 S * 3/2015 Hack D29/119
2003/0131393 A1 * 7/2003 Votolato A41D 13/081
2/16

(Continued)

OTHER PUBLICATIONS

Dexas Silicone Micromitt, posted at bedbathandbeyond.com, posting date not given, [online], [site visited Jul. 24, 2018]. Available from Internet, URL: <https://www.bedbathandbeyond.com/store/product/dexas-silicone-micromitt-trade-2-pack/1044890223> (Year: 2018).*

(Continued)

Primary Examiner — George D. Kirschbaum
Assistant Examiner — Maria J Edwards
(74) *Attorney, Agent, or Firm* — Jonathan M. D’Silva;
MMI Intellectual Property

(57) **CLAIM**

What is claimed the ornamental design for a finger mitt, as shown and described.

DESCRIPTION

FIG. 1 is a perspective view of a finger mitt showing my new design.
FIG. 2 is a front view of the finger mitt of FIG. 1;
FIG. 3 is a rear view of the finger mitt of FIG. 1;
FIG. 4 is a left side view of the finger mitt of FIG. 1;
FIG. 5 is a right side view of the finger mitt of FIG. 1;
FIG. 6 is a top view of the finger mitt of FIG. 1; and,
FIG. 7 is a bottom view of the finger mitt kit of FIG. 1.

1 Claim, 2 Drawing Sheets

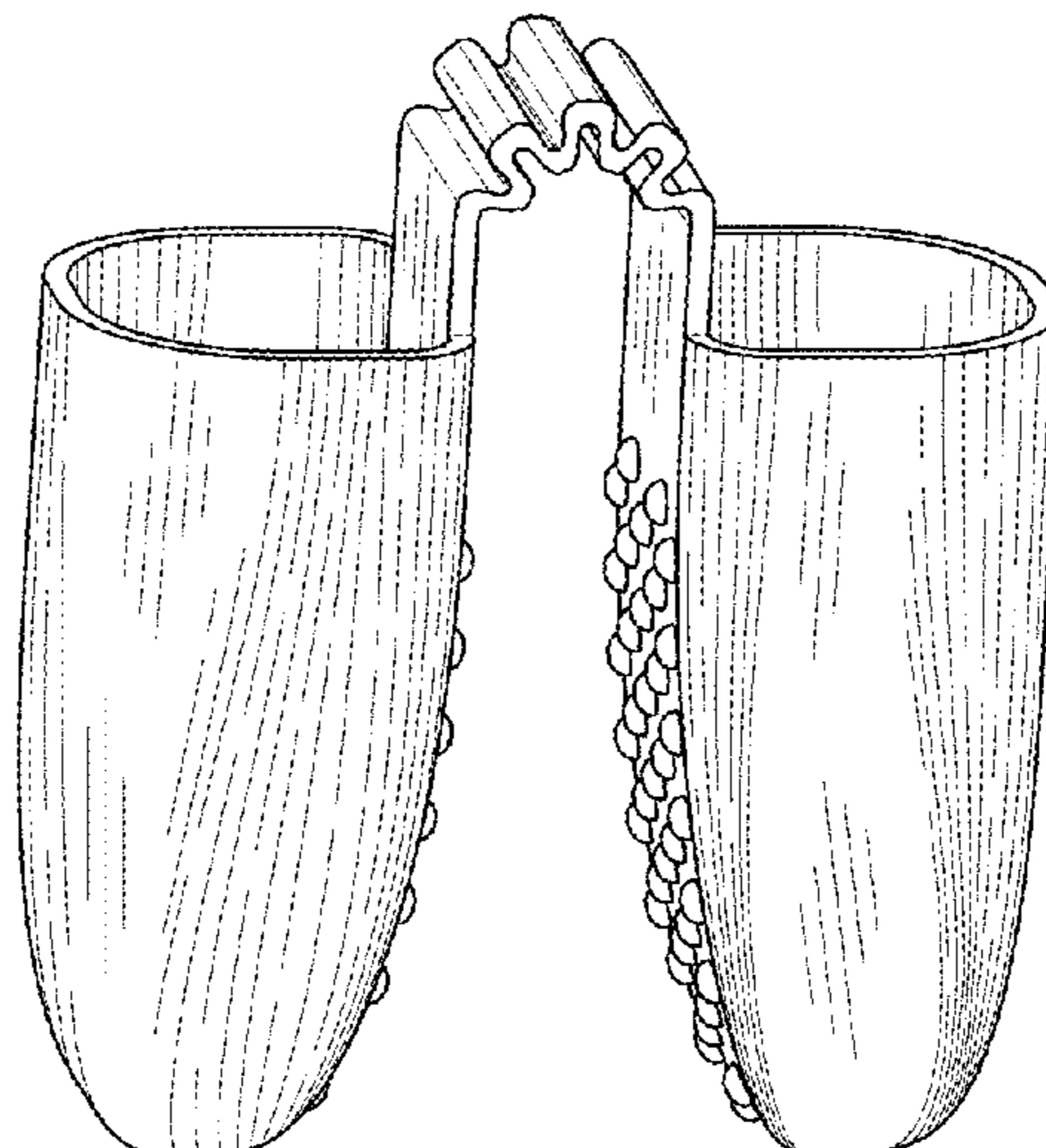

(56)

References Cited

U.S. PATENT DOCUMENTS

2005/0114983 A1* 6/2005 Demay A41D 19/01529
2/160

OTHER PUBLICATIONS

Doftfunkia Pinch holder Green, posted at ikea.com, posting date not given, [online], [site visited Jul. 24, 2018]. Available from Internet, URL: <https://www.ikea.com/gb/en/products/textiles-rugs/tea-towels-aprons-oven-gloves/doftfunkia-pinch-holder-green-art-50330258/> (Year: 2018).*

Insulated Glove, posted at joom.com, posting date not given, [online], [site visited Jul. 24, 2018]. Available from Internet, URL: <https://www.joom.com/en/products/1509445678545129003-250-1-709-2503764183> (Year: 2018).*

Silicone Heat Resistant Cooking Pinch Oven Mitts, posted at aliexpress.com, no posting date, [online], [site visited Jul. 24, 2018]. Available from Internet, URL: <https://www.aliexpress.com/item/1PC-Kitchen-Non-slip-Heat-Resistant-Oven-Mitts-Silicone-Glove-Grip-Oven-Pot-Holder-Baking-BBQ/32721728561.html> (Year: 2018).*

Silicone Insulated Finger Glove Mitt, posted at dhgate.com, posting date not given, [online], [site visited Jul. 24, 2018]. Available from Internet, URL: <https://www.dhgate.com/product/silicone-oven-heat-insulated-finger-glove/407701592.html> (Year: 2018).*

* cited by examiner

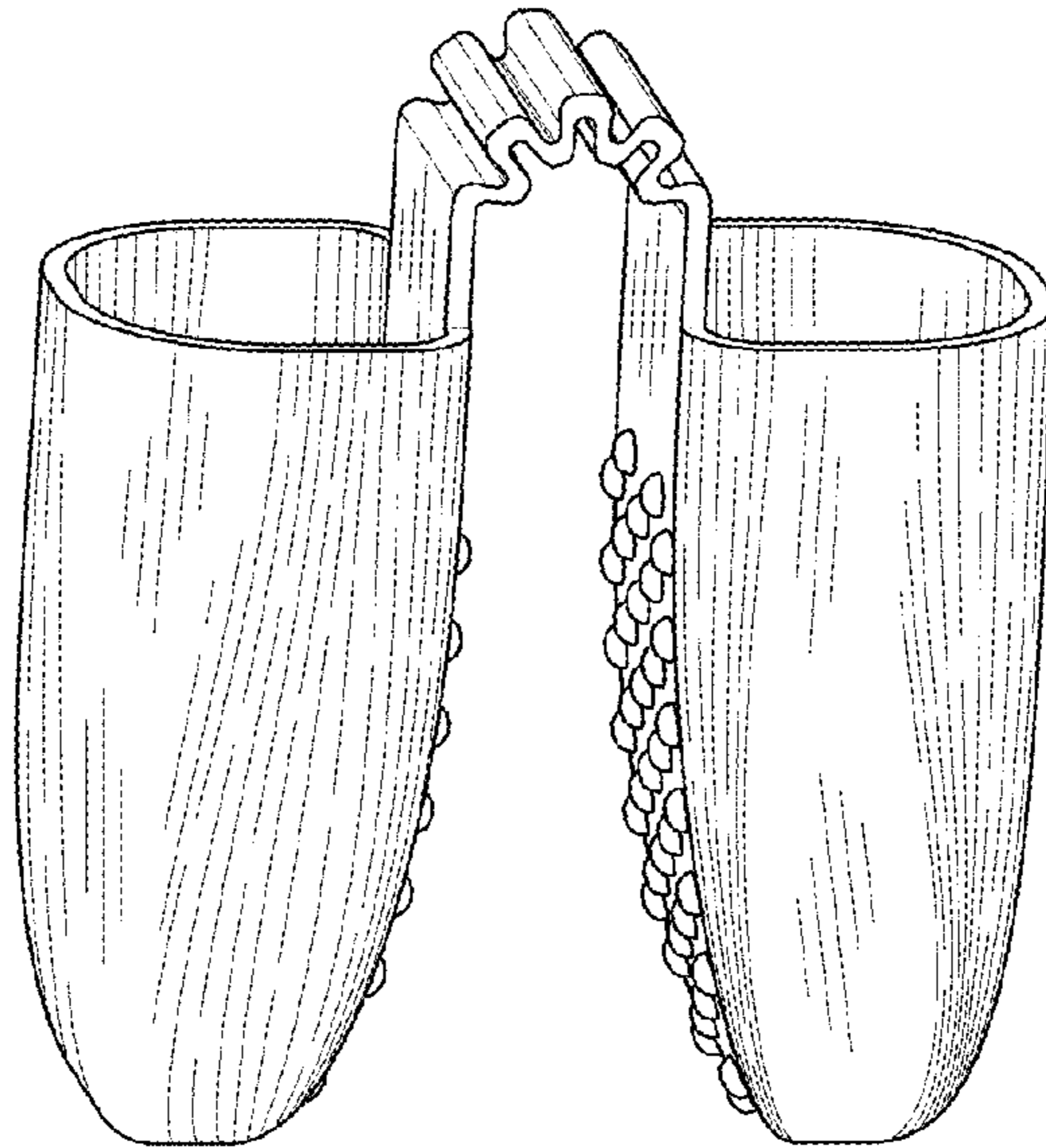

Fig. 1

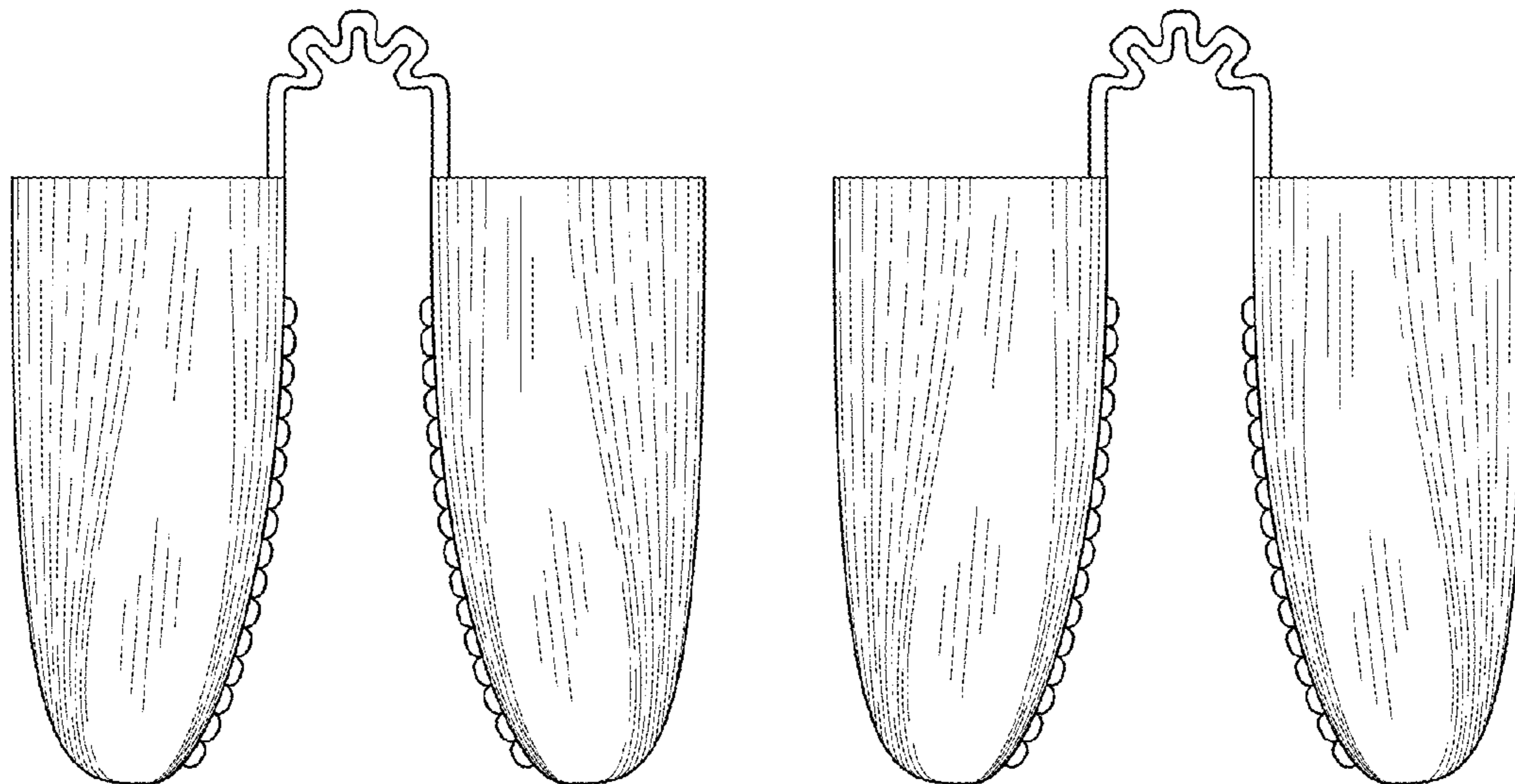

Fig. 2

Fig. 3

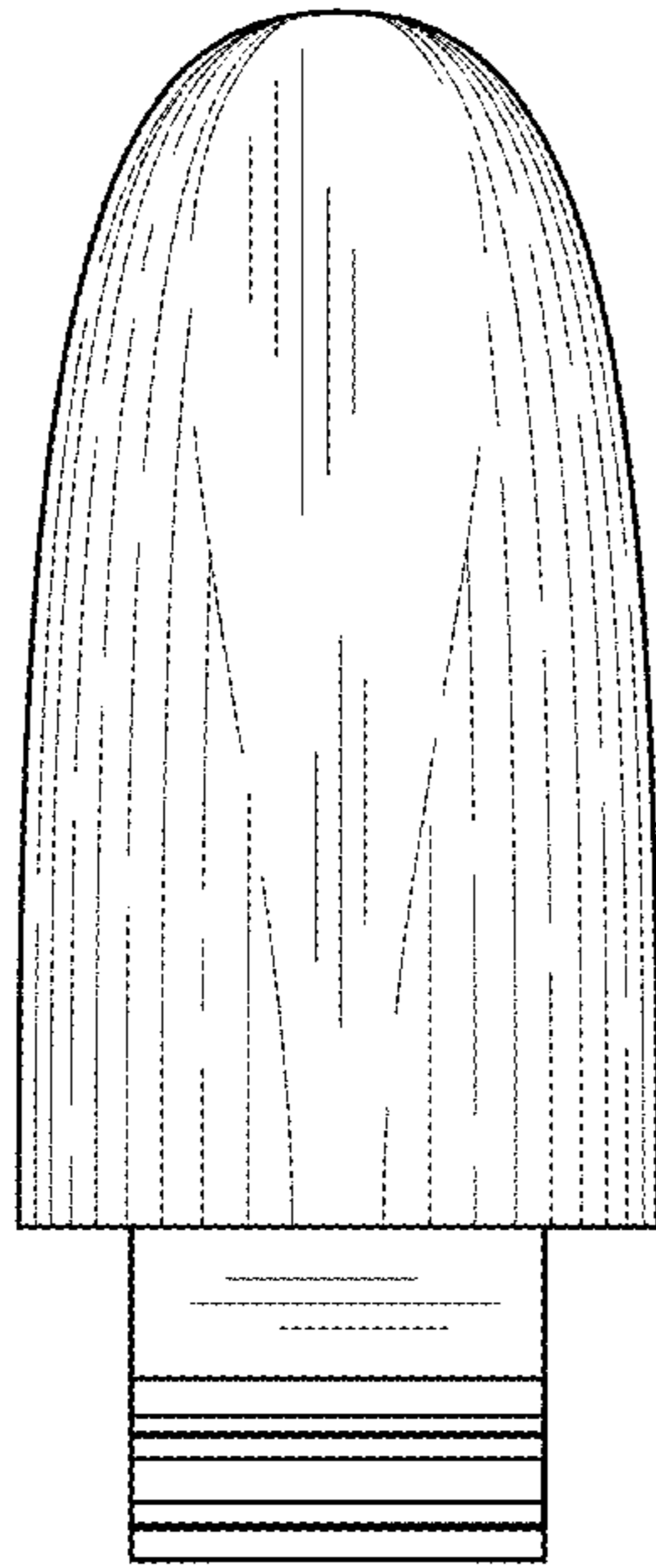

Fig. 4

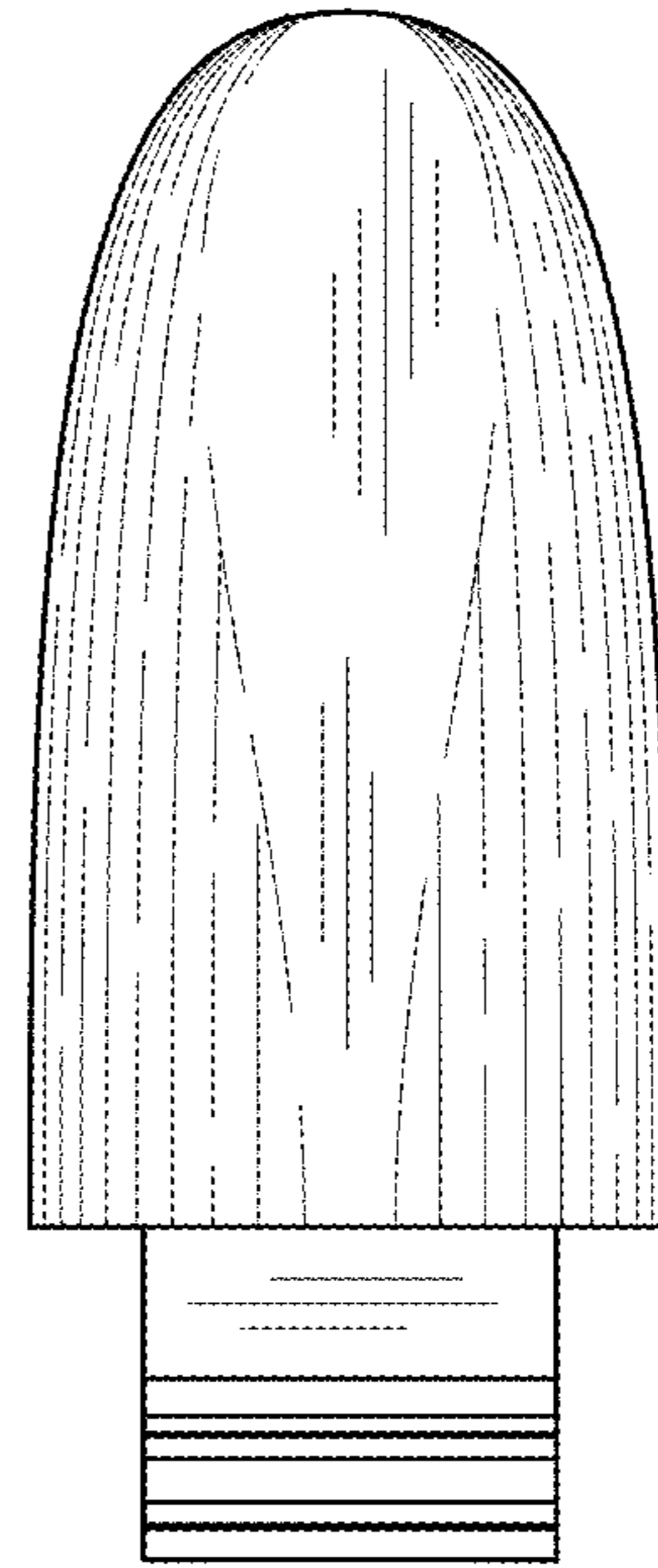

Fig. 5

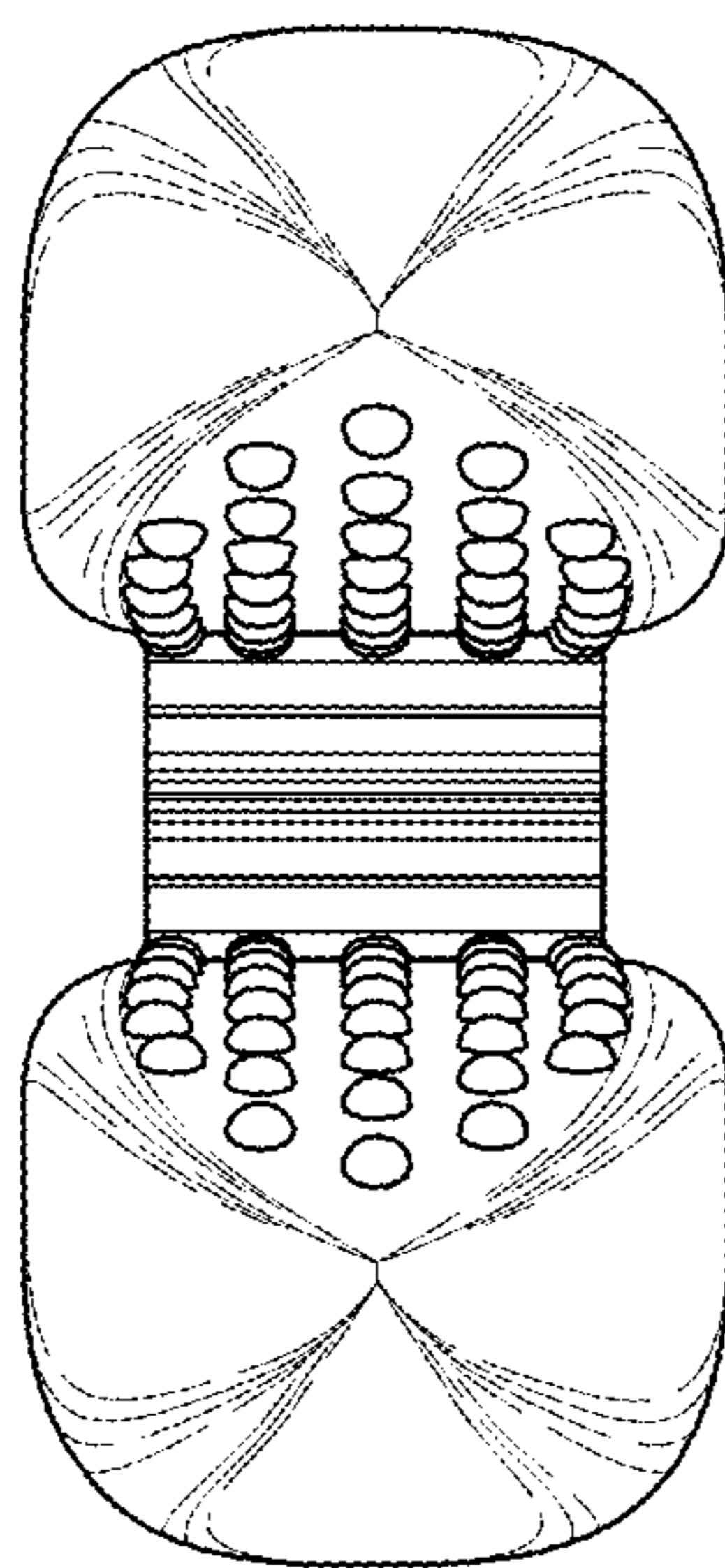

Fig. 6

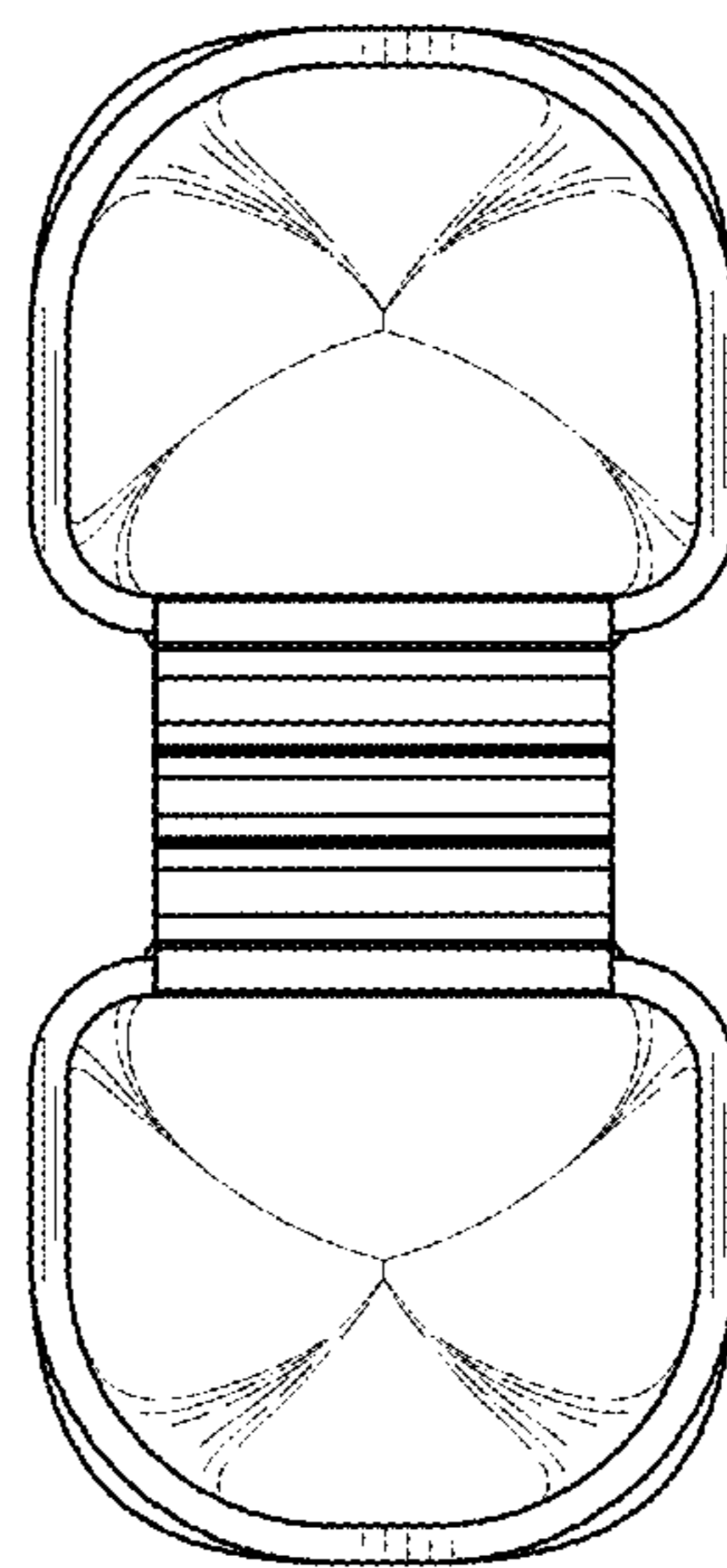

Fig. 7