



US00D831780S

(12) **United States Design Patent** (10) **Patent No.:** **US D831,780 S**
Geissele (45) **Date of Patent:** **** Oct. 23, 2018**

(54) **FIREARM MOUNT**

(56) **References Cited**

(71) Applicant: **WHG Properties, LLC**, North Wales, PA (US)

U.S. PATENT DOCUMENTS

(72) Inventor: **William H. Geissele**, Lower Gwynedd, PA (US)

D127,735 S *	6/1941	Dreyfuss	74/553
2,671,287 A	3/1954	Hayes	
D187,412 S *	3/1960	Young	D23/250
3,091,878 A	6/1963	Savioli	
3,269,045 A	8/1966	McGaughey	
D253,513 S *	11/1979	Bertani	D8/307
D269,409 S *	6/1983	Ferdinand	D8/307
D276,838 S *	12/1984	Hill	16/441

(73) Assignee: **WHG Properties, LLC**, North Wales, PA (US)

(Continued)

(**) Term: **15 Years**

(21) Appl. No.: **29/635,354**

OTHER PUBLICATIONS

(22) Filed: **Jan. 30, 2018**

VTT Knobs with solid section, Elessa-Ganter.com, [online], [site visited May 16, 2018]. <URL: <https://www.elesa-ganter.com/products/clamping-knobs/series/vtt>> (Year: 2018).*

(Continued)

Related U.S. Application Data

(62) Division of application No. 29/584,526, filed on Nov. 15, 2016.

(51) **LOC (11) Cl.** **22-01**

Primary Examiner — T Chase Nelson

(52) **U.S. Cl.**
USPC **D22/110**; D22/108; D22/109

Assistant Examiner — Jonathan J. Han

(74) *Attorney, Agent, or Firm* — Fox Rothschild LLP

(58) **Field of Classification Search**
USPC D22/108–110; D16/130, 132–134, 330; 89/111–113; 359/399, 823; 42/104, 105, 42/111–113, 116, 120, 124–126, 42/127–129, 141–148, 133–140; 33/227, 33/229; D8/343, 300–310; 74/522–557; 16/110.1, 429, 432; D12/174–178
CPC F41G 1/00; F41G 1/01; F41G 1/02; F41G 1/06; F41G 1/065; F41G 1/08; F41G 1/10; F41G 1/12; F41G 1/14; F41G 1/30; F41G 1/32; F41G 1/38; F41G 1/40; F41G 1/42; F41G 1/44; F41G 1/46; F41G 1/383; F41G 1/387; F41G 1/393; F41G 3/00; F41G 3/005; F41G 3/02; F41G 3/04; F41G 3/06; F41G 3/14; F41G 11/001; F41G 11/002; F41G 11/003; F41G 11/004; F41G 11/005

See application file for complete search history.

(57) **CLAIM**

The ornamental design for a firearm mount, as shown and described.

DESCRIPTION

FIG. 1 is a top, front, left side perspective view of a firearm mount in accordance with the present disclosure; FIG. 2 is a front view of the firearm mount of FIG. 1. FIG. 3 is a rear view of the firearm mount of FIG. 1. FIG. 4 is a right side view of the firearm mount of FIG. 1. FIG. 5 is a left side view of the firearm mount of FIG. 1. FIG. 6 is a top view of the firearm mount of FIG. 1; and, FIG. 7 is a bottom view of the firearm mount of FIG. 1. The broken lines in the Figures illustrate portions of the article that form no part of the claimed design.

1 Claim, 6 Drawing Sheets

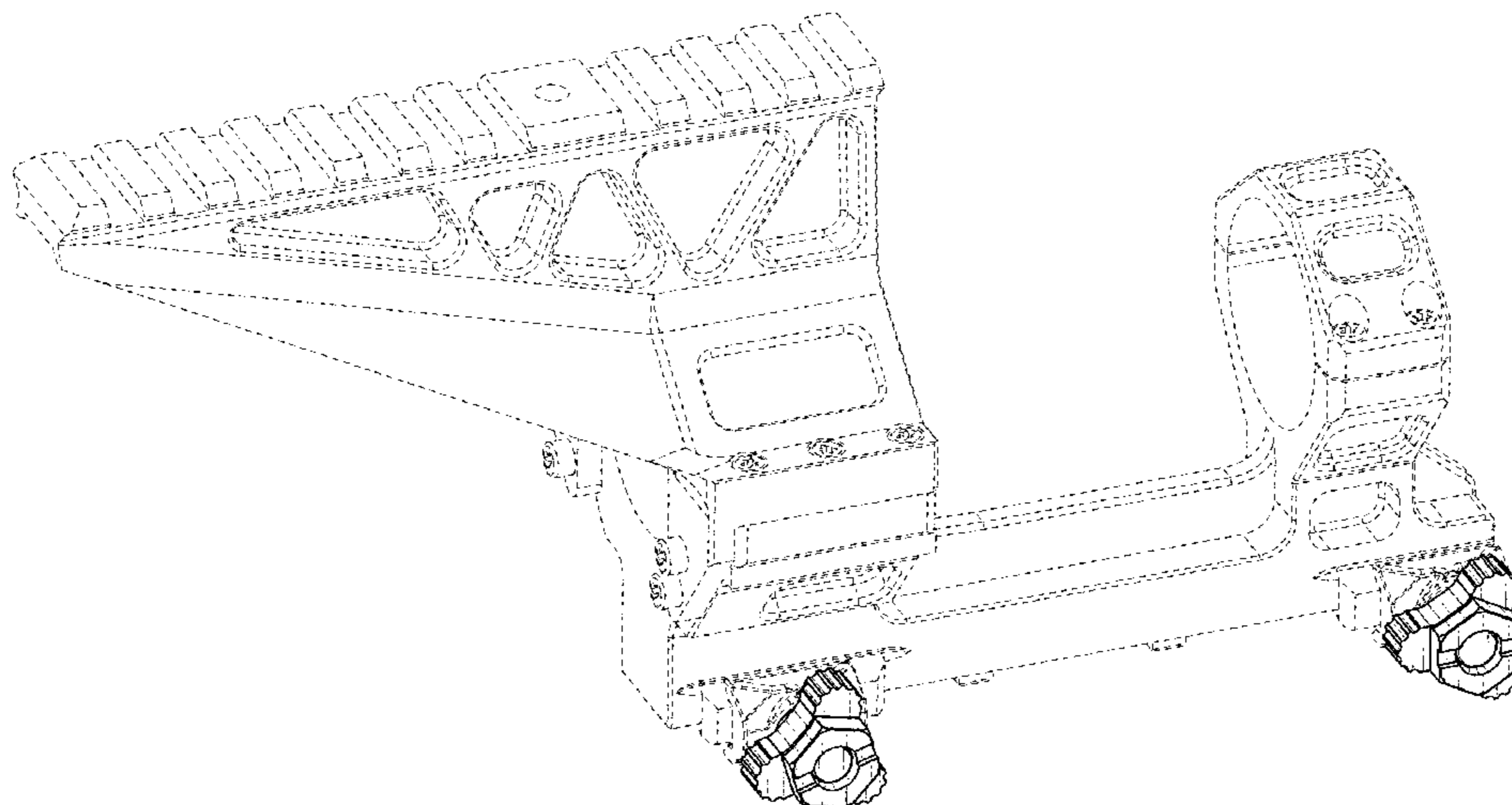

(56)

References Cited

U.S. PATENT DOCUMENTS

D291,470 S 8/1987 Bechtel
 4,709,617 A 12/1987 Anderson
 D318,313 S 7/1991 Bechtel
 D318,708 S 7/1991 Bechtel
 5,417,002 A 5/1995 Guerra
 D367,312 S 2/1996 Martel
 D409,156 S * 5/1999 Taylor D13/174
 D410,061 S 5/1999 Emerson
 5,941,489 A * 8/1999 Fanelli F41G 1/16
 248/298.1
 D434,475 S * 11/2000 Meda D23/252
 D435,885 S 1/2001 Wallace
 D462,111 S * 8/2002 Turnau, III D23/252
 D463,246 S * 9/2002 Becker D8/306
 D464,249 S * 10/2002 Laabs D8/343
 D467,789 S * 12/2002 Laabs D8/341
 D486,878 S 2/2004 Selvaggio
 D493,348 S * 7/2004 Bertani D15/142
 D508,021 S * 8/2005 Wirth 439/755
 D511,365 S 11/2005 Ding
 D513,056 S 12/2005 Ding
 D513,298 S 12/2005 Ding
 D513,299 S 12/2005 Ding
 D513,633 S 1/2006 Ding
 D520,949 S * 5/2006 Wirth D13/120
 D533,618 S 12/2006 Swan
 D537,901 S 3/2007 Elkaim
 D537,902 S 3/2007 Elkaim
 D539,632 S * 4/2007 Ma D8/307
 D542,880 S 5/2007 Cheng
 D543,605 S 5/2007 Cheng
 D548,811 S 8/2007 Swan
 D554,730 S 11/2007 Coggins
 D555,750 S 11/2007 Cheng
 D555,751 S 11/2007 Cheng
 D559,775 S * 1/2008 Liukkula D12/608
 D575,619 S * 8/2008 Bertani D8/309
 D577,495 S * 9/2008 Borovicka D4/138
 7,481,016 B2 1/2009 Gonzalez
 D594,085 S 6/2009 Moody
 D607,959 S 1/2010 Moody
 D609,550 S * 2/2010 Wan D8/300
 D632,753 S 2/2011 Leighton
 7,900,390 B2 * 3/2011 Moody F41A 23/08
 42/71.01
 D644,085 S * 8/2011 Jungen D8/307
 D654,134 S 2/2012 Edge et al.
 D664,232 S 7/2012 Storch
 D668,761 S * 10/2012 Schad D24/133
 D672,840 S 12/2012 Neufeld
 D673,239 S 12/2012 Cheng
 8,522,469 B2 9/2013 Baker
 8,528,140 B1 9/2013 Phillips
 D713,921 S 9/2014 Williams
 D715,393 S 10/2014 Williams
 D718,832 S 12/2014 Huang
 9,015,982 B1 4/2015 Powers
 D732,628 S 6/2015 Cheng et al.
 D738,986 S 9/2015 Anderson
 D739,912 S 9/2015 Norberg
 D741,442 S 10/2015 Wilson
 D761,929 S 7/2016 Hormann
 D762,098 S * 7/2016 Bertani D8/307
 D762,439 S * 8/2016 Bertani D8/309
 D768,257 S 10/2016 Boyd
 9,470,480 B2 10/2016 Kirchhoff
 D779,623 S 2/2017 Geissele
 D781,985 S 3/2017 McKillips
 D781,987 S 3/2017 Geissele
 D783,112 S 4/2017 Geissele
 D783,759 S 4/2017 Geissele
 D784,787 S * 4/2017 Bertani D8/307
 D787,007 S 5/2017 Maughn
 9,644,913 B2 5/2017 Dextraze
 9,733,034 B1 8/2017 Viani

D798,129 S * 9/2017 Bertani D8/309
 D802,077 S 11/2017 Geissele
 9,857,146 B1 1/2018 Shelton et al.
 D813,639 S * 3/2018 Osanai D8/307
 D817,437 S 5/2018 Hancosky
 2005/0183311 A1 8/2005 Diaz et al.
 2005/0229465 A1 10/2005 Dextraze
 2008/0005952 A1 1/2008 Sutherby
 2009/0038201 A1 2/2009 Cheng et al.
 2011/0167696 A1 7/2011 Gangl
 2011/0197491 A1 8/2011 McCann
 2013/0008073 A1 1/2013 Clifton et al.
 2013/0185985 A1 7/2013 Ballard
 2013/0312309 A1 11/2013 Rorick
 2014/0259854 A1 9/2014 Williams
 2015/0198397 A1 7/2015 Motley
 2016/0102946 A1 4/2016 Sharron et al.
 2016/0102947 A1 4/2016 Visinski
 2016/0363416 A1 12/2016 Klotz
 2017/0059280 A1 3/2017 Fravor

OTHER PUBLICATIONS

Tekton 26756 10 pc Slotted and Phillips Screwdriver Set, Ebay.com, [online], [site visited May 16, 2018]. <URL: <https://www.ebay.com/itm/Tekton-26756-10-Pc-Slotted-and-Phillips-Screwdriver-Set-3-Sided-Handle-USA-Made-/222696470652>> (Year: 2018).*

Mount three-way Pivot Arm assembly extension + 2 knob screw bolt nut for Gopro HD, Ebay.com, [online], [site visited May 16, 2018]. <URL: <https://www.ebay.com/itm/mount-three-way-Pivot-Arm-assembly-extension-2-knob>> (Year: 2018).*

Krofel Magnetic Vehicle Air Vent Mount with Adjustable Knob, Krofel.com, [online], [site visited May 16, 2018]. <URL: <https://www.krofel.com/product/krofel-magnetic-car-air-vent-holder/>> (Year: 2018).*

TFB Review: Armageddon Tactical AK47 Hinged Side Rail Mount, TheFirearmBlog.com, Aug. 23, 2017, <http://www.thefirearmblog.com/blog/2017/08/23/tfb-review-armageddon-tactical-ak47-hinged-side-rail-mount>.

SKS See Thru Scout Scope Mount by Brass Stacker, MountPlus.com, http://www.mountplus.com/AR-15_Accessories/AR-15_Scope_Rings/151-TGR-SKS-SSM.html (2018).

Trinity Force 30mm Monolithic Quick-Detach Scope Mount w/Top Rail and 1-inch Inserts, DeltaTeamTactical.com, https://www.deltateamtactical.com/Trinity-Force-30mm-Monolithic-Quick-Detach-Scope-Mount-wTop-Rail-and-1-inch-Inserts_p_4613.html (2018).

FAB Defense Glock Tactical Scope Mount, MidwayUSA.com, <https://www.midwayusa.com/product/1008970315/fab-defense-glock-tactical-scope-mount-all-railed-glock-models> (2018).

Mini 14 Tactical Metal Quad-rail Handguard, IFAtactical.com, <http://www.ifatactical.com/page/19264196> (2018).

Remington 870 Tactical Mount by Barska, Barska.com, <https://www.barska.com/remington-870-tactical-mount-rail-by-barska.html> (2018).

FM Tactical Scope Mount with 1" Rings and Picatinny Rails on Rings, JGsales.com, <http://www.jgsales.com/fm-tactical-scope-mount-with-1-rings-and-picatinny-rails-on-rings,-black,-fntml1.-p-3760.html> (2018).

LaRue Tactical Scope Mount QD LT745, LaRue.com, <https://www.larue.com/products/larue-tactical-scope-mount-qd-lt745/> (2018).

Midwest Industries AK Railed Side Scope Mount Aluminum Black MI-AKSM, CheaperThanDirt.com, [online], [site visited May 16, 2018]. <URL: <https://www.cheaperthandirt.com/product/midwest-industries-ak-railed-side-scope-mount-aluminum-black-mi-aksm-816537012030.do>> (Year: 2018).

H&R1871 NEF Pardner Pump Shotgun Scope Base Rail Mount, TrinitySupply.com, [online], [site visited May 16, 2018]. <URL: <https://www.trinitysupply.com/H-R-1871-shotgun-saddle-mount-p/295.htm>> (Year: 2018).

(56)

References Cited

OTHER PUBLICATIONS

Install Badger Embedded Front Rail (EFR), ShortActionCustoms.com, by admin, Jan. 17, 2011, [online], [site visited May 16, 2018]. <URL: <http://shortactioncustoms.com/install-badger-embedded-front-frail-efr/>> (Year: 2011).

* cited by examiner

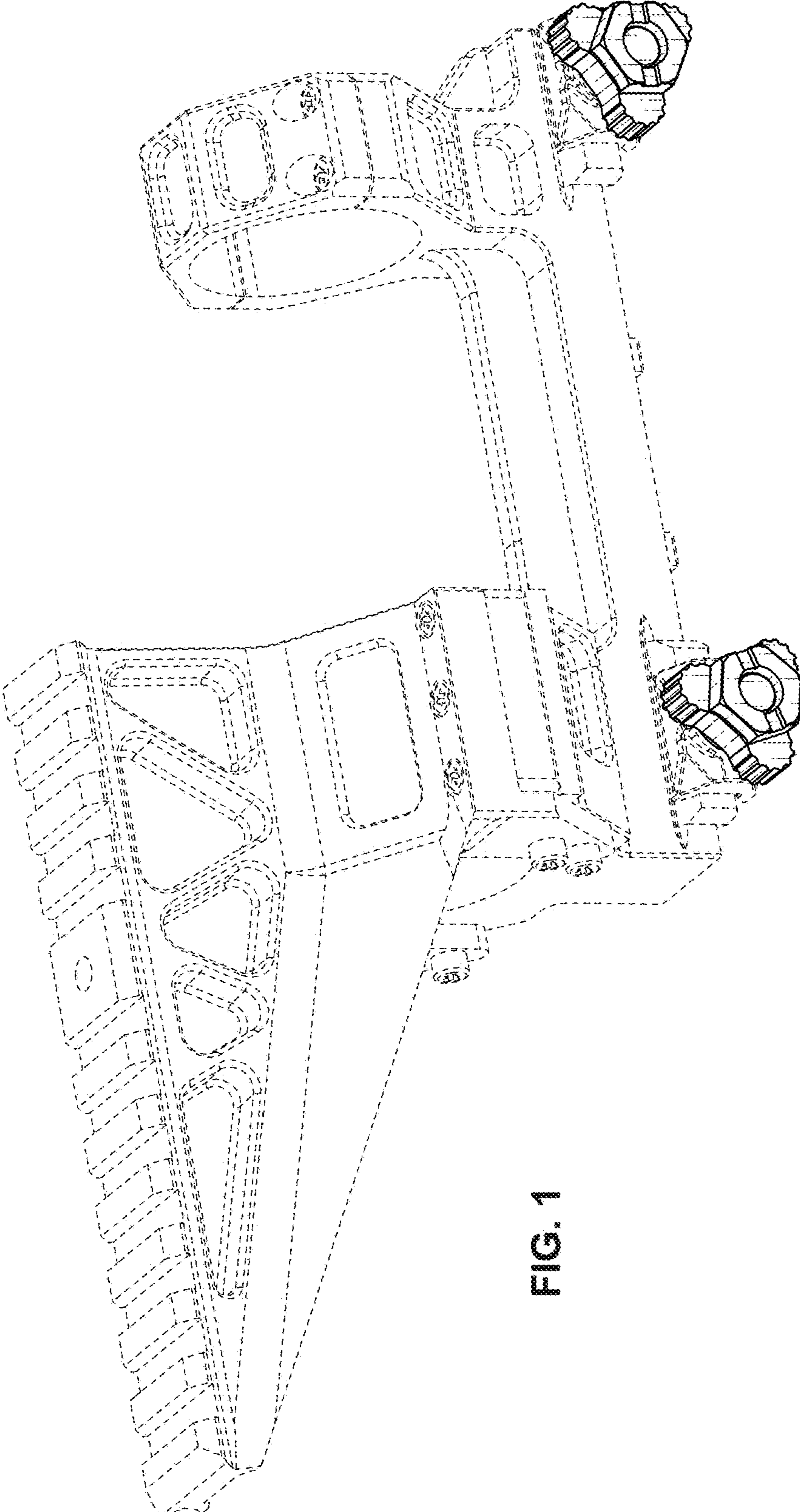

FIG. 1

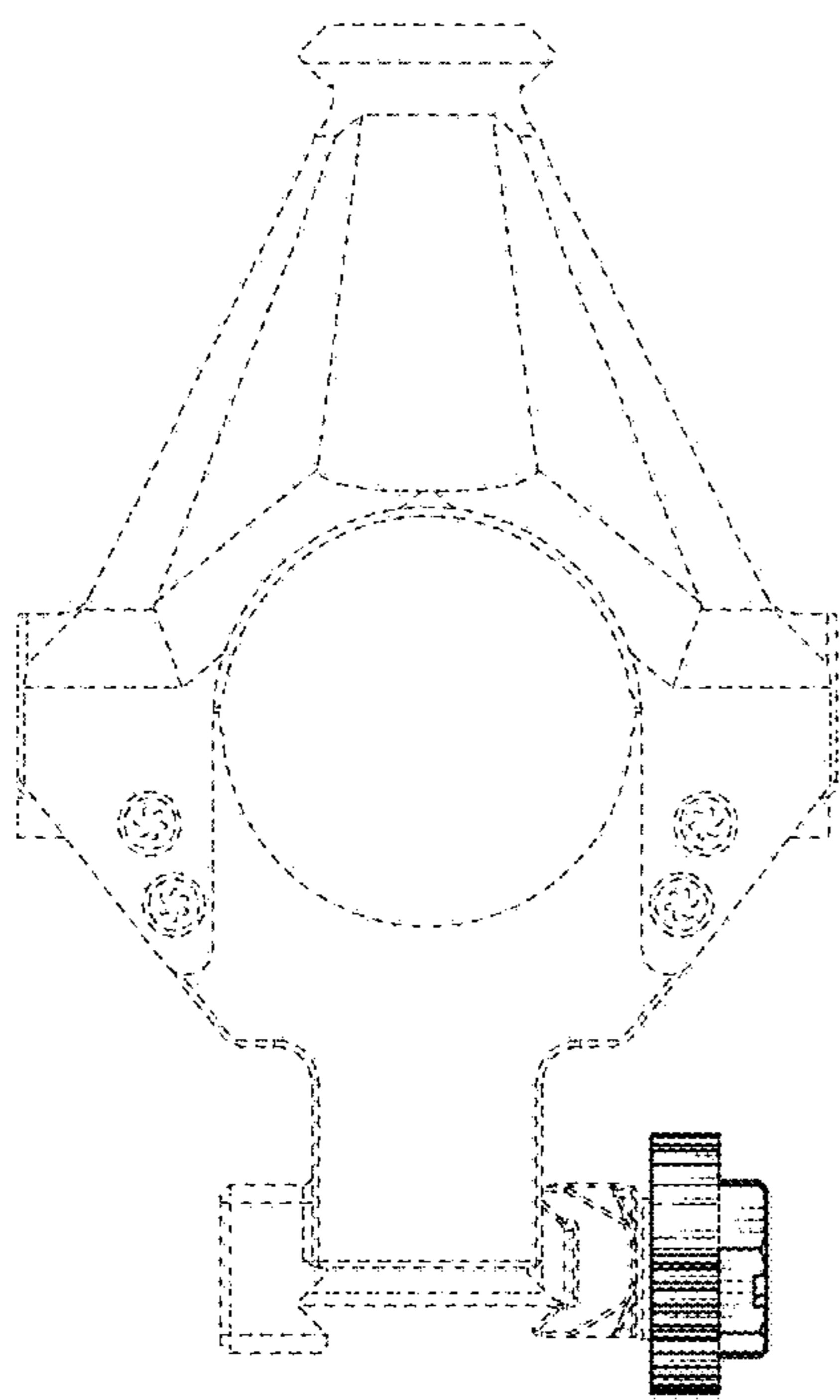

FIG. 2

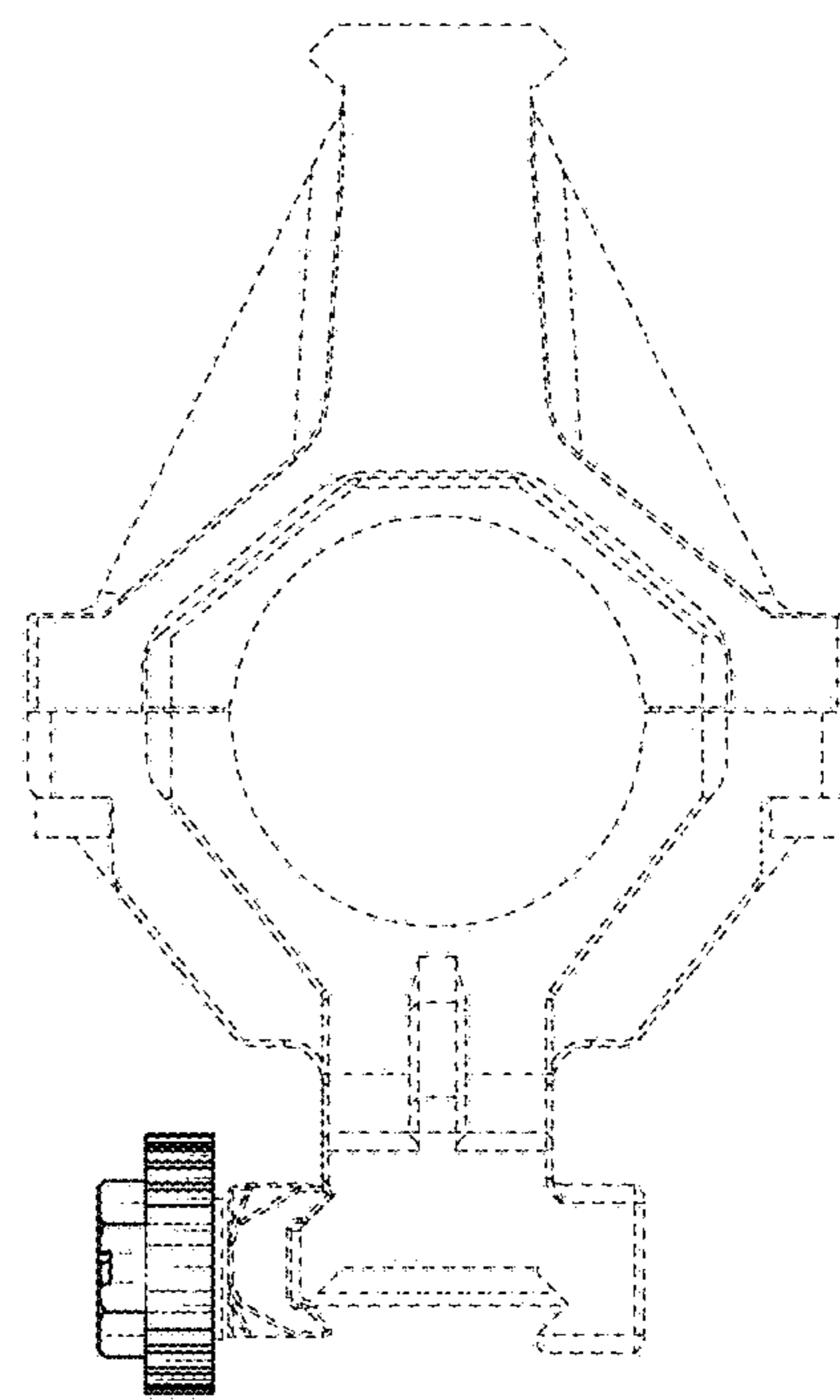

FIG. 3

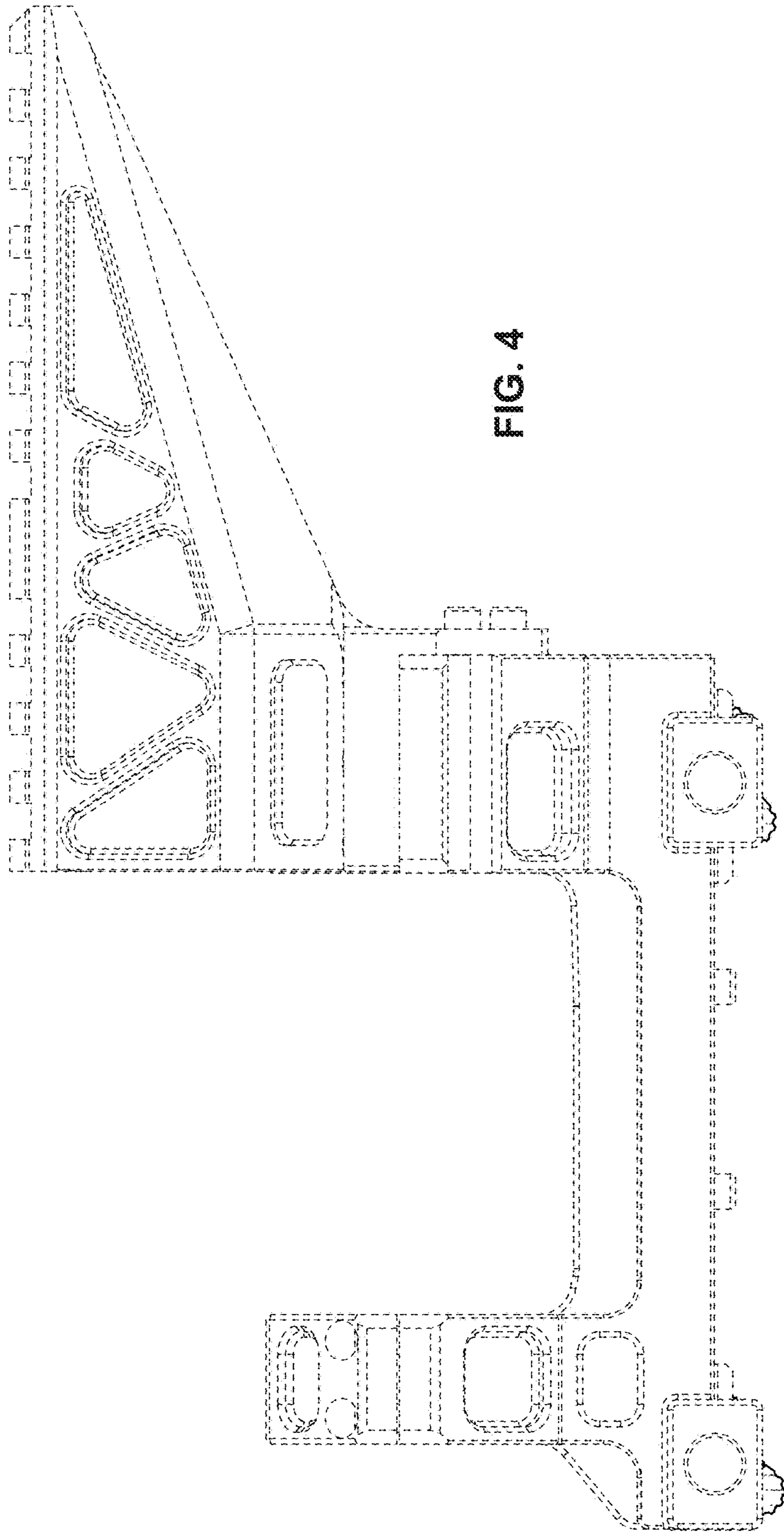

FIG. 4

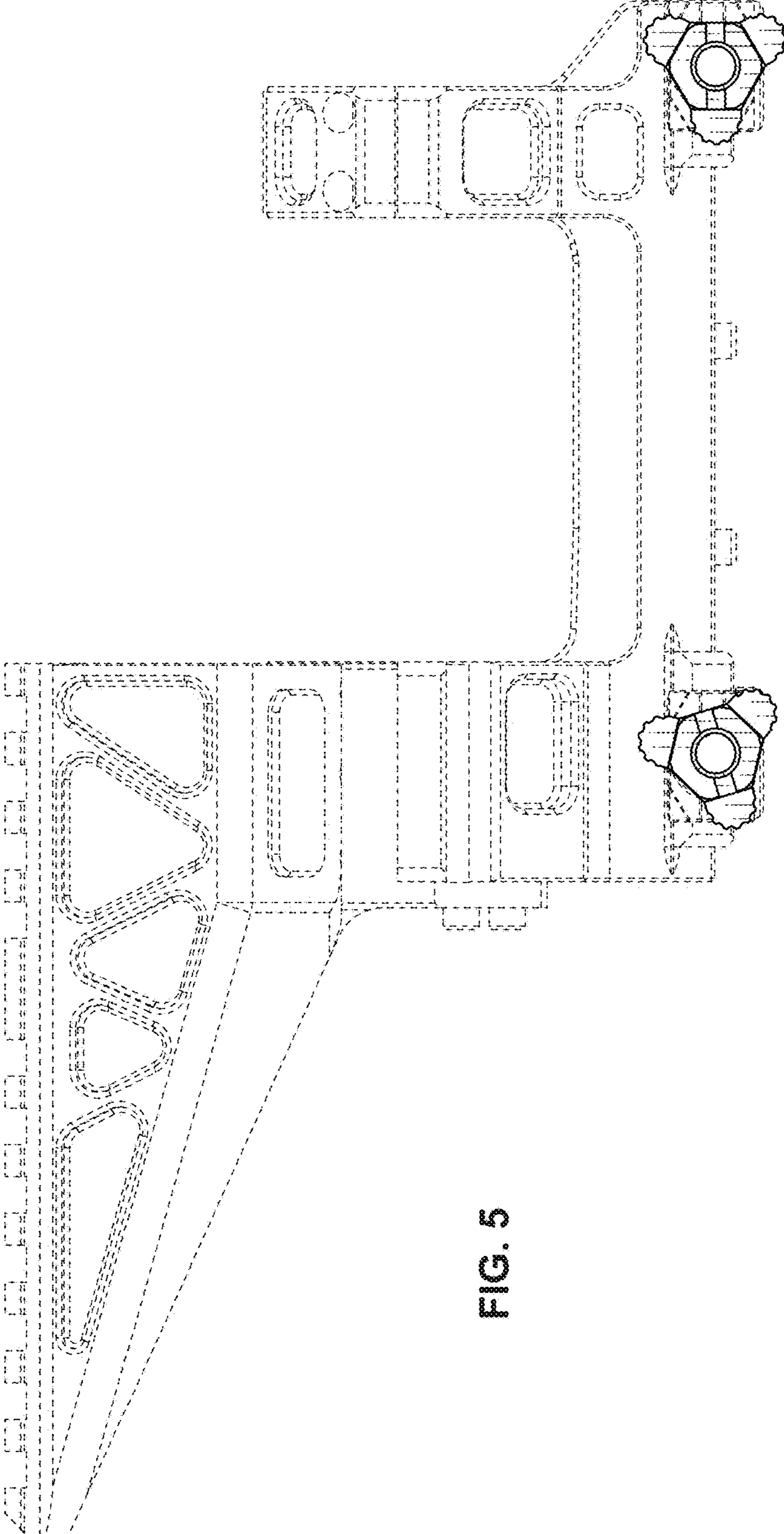

FIG. 5

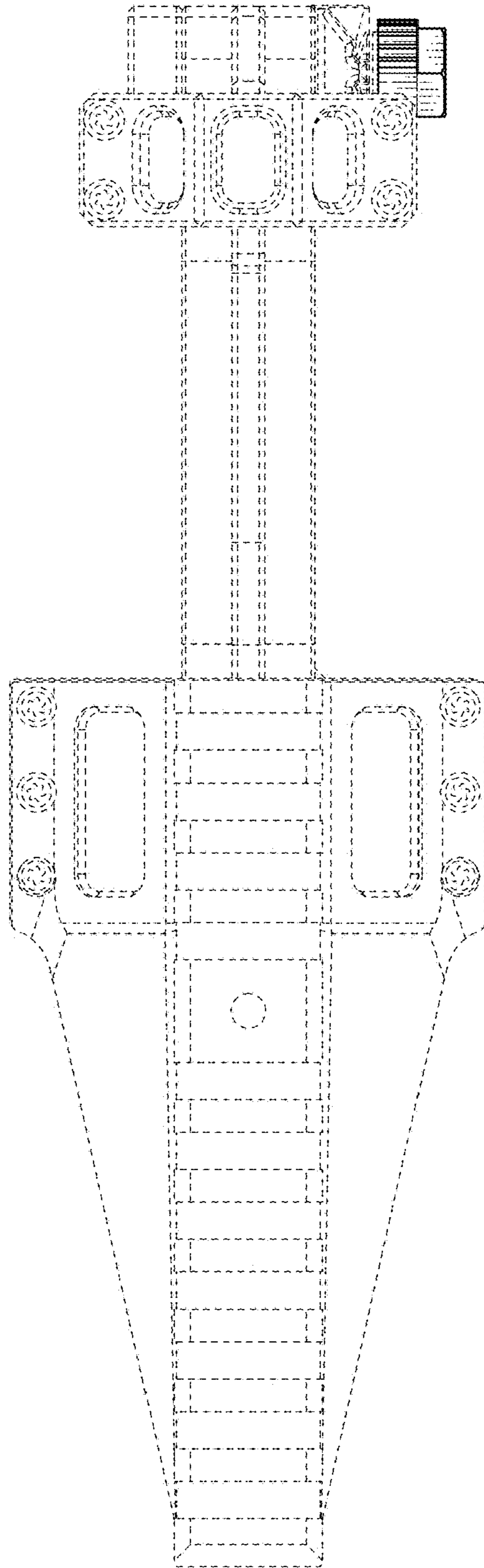

FIG. 6

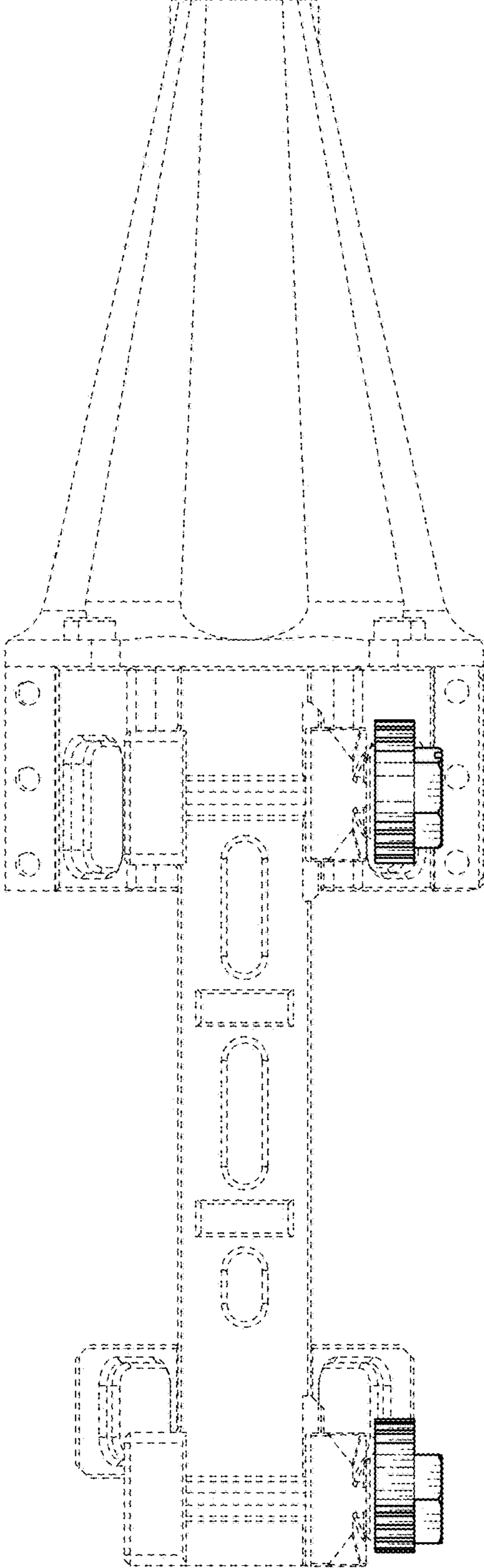

FIG. 7