



US00D831568S

(12) **United States Design Patent**  
**Kaishian et al.**

(10) **Patent No.:** **US D831,568 S**  
(45) **Date of Patent:** **\*\* Oct. 23, 2018**

- (54) **BUS CONNECTOR SYSTEM** 3,827,007 A \* 7/1974 Fairbairn ..... H01R 13/28  
439/293
- (71) Applicant: **ROCKWELL AUTOMATION** 4,288,139 A \* 9/1981 Cobough ..... H01R 12/89  
**TECHNOLOGIES, INC.**, Mayfield  
Heights, OH (US) 4,758,172 A \* 7/1988 Richards ..... H01R 25/14  
174/72 B
- (72) Inventors: **Steven C. Kaishian**, Wauwatosa, WI 4,762,500 A \* 8/1988 Dola ..... H01R 23/688  
(US); **Jeremy J. Keegan**, Kewaskum, WI 4,806,107 A \* 2/1989 Arnold ..... H01R 23/688  
(US); **Yogesh P. Patel**, Grafton, WI 439/101  
(US); **Bruce W. Weiss**, Milwaukee, WI D345,961 S \* 4/1994 Bucher ..... D13/147  
(US) 5,382,168 A \* 1/1995 Azuma ..... H01R 12/716  
439/571
- (73) Assignee: **ROCKWELL AUTOMATION** 5,462,456 A \* 10/1995 Howell ..... H01R 13/41  
**TECHNOLOGIES, INC.**, Mayfield  
Heights, OH (US) D365,804 S \* 1/1996 Klaus ..... D13/160  
(Continued)

- (\*\*) Term: **15 Years**
- (21) Appl. No.: **29/538,521**
- (22) Filed: **Sep. 4, 2015**

**Related U.S. Application Data**

- (62) Division of application No. 29/459,279, filed on Jun. 27, 2013, now Pat. No. Des. 738,304.
- (51) **LOC (11) Cl.** ..... **13-02**
- (52) **U.S. Cl.**  
USPC ..... **D13/110**
- (58) **Field of Classification Search**  
USPC ..... D13/107, 110, 133, 146, 147, 154, 184,  
D13/199, 148, 156, 149; 439/607.01,  
439/607.04, 607.17, 607.25, 607.34,  
439/607.53, 660, 677, 680, 682, 686;  
174/68.2, 84 C  
CPC .... H02G 5/025; H01R 12/716; H01R 12/721;  
H01L 35/02; H02B 1/20  
See application file for complete search history.

(56) **References Cited**

**U.S. PATENT DOCUMENTS**

- 3,157,448 A \* 11/1964 Crimmins ..... H01R 13/28  
439/295
- 3,482,201 A \* 12/1969 Schneck ..... H01R 31/00  
439/496

*Primary Examiner* — Derrick Holland  
*Assistant Examiner* — Jennifer O King  
(74) *Attorney, Agent, or Firm* — Fletcher Yoder, P.C.

(57) **CLAIM**

The ornamental design for a bus connector system, as shown and described.

**DESCRIPTION**

FIG. 1 is a front top perspective view of a bus connector system;  
FIG. 2 is a top plan view thereof;  
FIG. 3 is a bottom plan view thereof;  
FIG. 4 is a left side elevational view thereof;  
FIG. 5 is a right side elevational view thereof;  
FIG. 6 is a rear side elevational view thereof; and,  
FIG. 7 is a front side elevational view thereof.  
The broken lines shown represent portions of the bus connector system that form no part of the design.

**1 Claim, 4 Drawing Sheets**

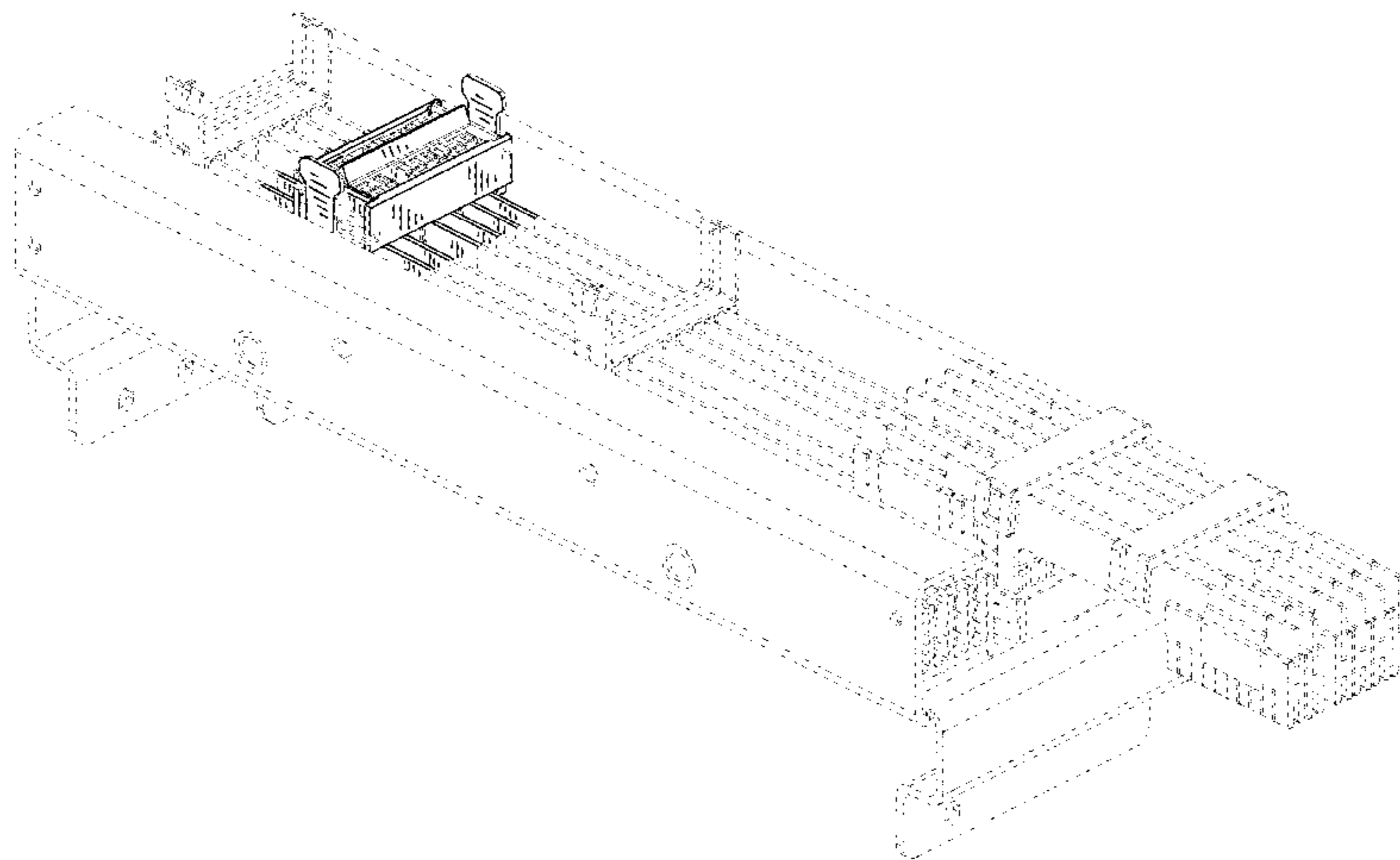

(56)

**References Cited**

U.S. PATENT DOCUMENTS

5,904,581 A \* 5/1999 Pope ..... H01R 12/716  
439/74  
8,277,241 B2 \* 10/2012 Horchler ..... H01R 13/6271  
439/295  
D697,032 S \* 1/2014 Ohashi ..... D13/159  
9,093,804 B2 \* 7/2015 Matocky ..... H01R 12/7088  
D750,025 S \* 2/2016 Buck ..... D13/147  
D758,321 S \* 6/2016 Byrne ..... D13/156  
2009/0250237 A1 \* 10/2009 Akahori ..... H01R 9/226  
174/68.2  
2012/0222881 A1 \* 9/2012 Van Dooren ..... H02B 1/20  
174/68.2  
2014/0054061 A1 \* 2/2014 Kaishian ..... H02G 5/025  
174/68.2  
2014/0158395 A1 \* 6/2014 Billman ..... H02G 5/02  
174/68.2

\* cited by examiner

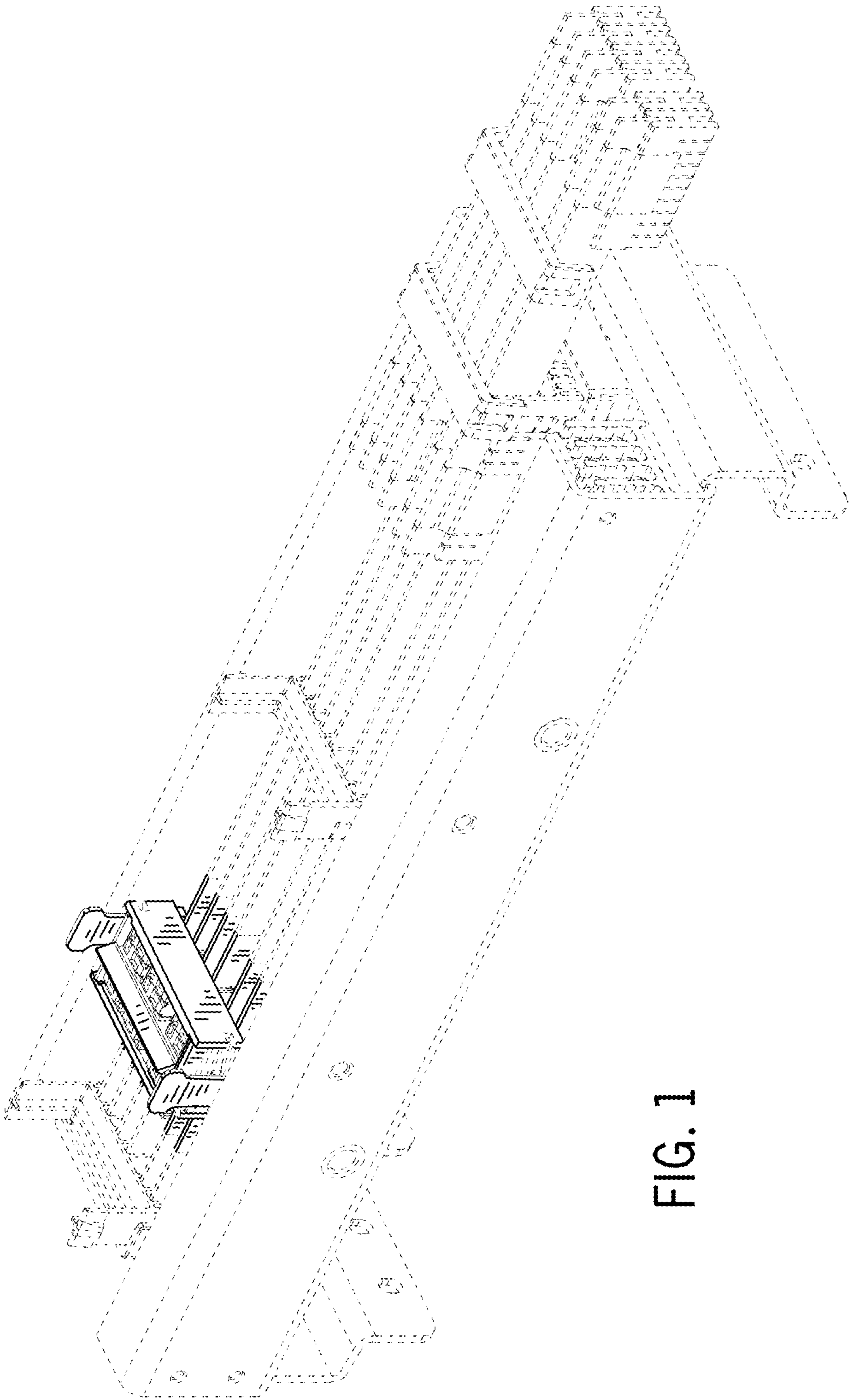

FIG. 1

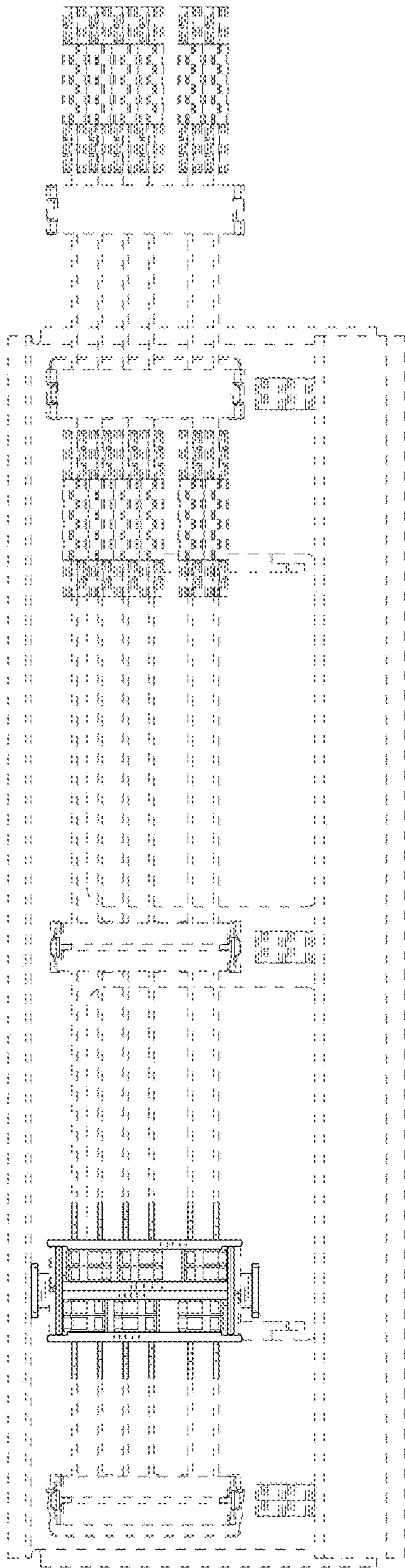

FIG. 2

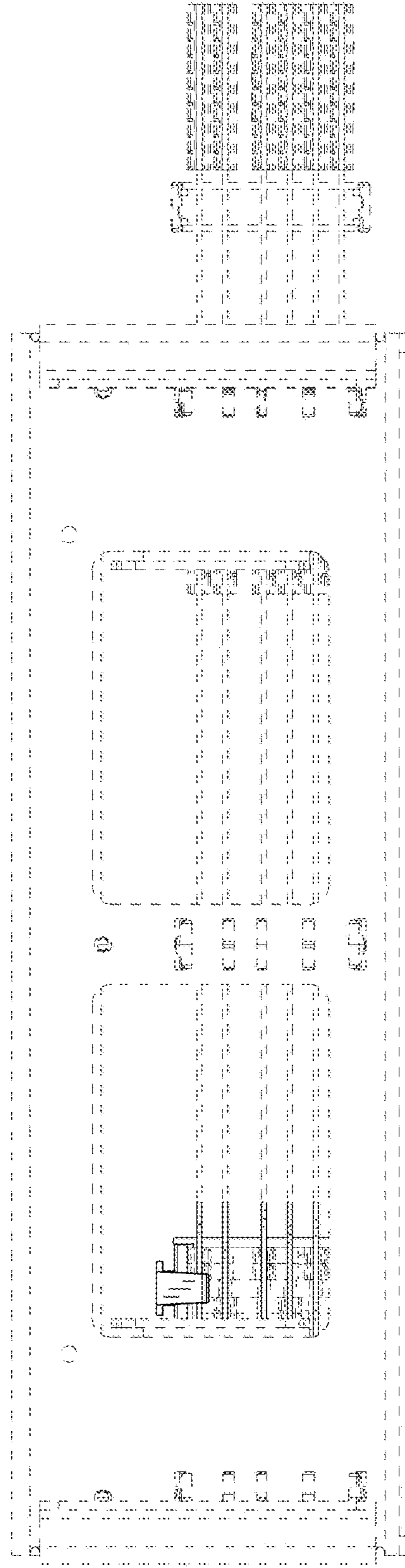

FIG. 3

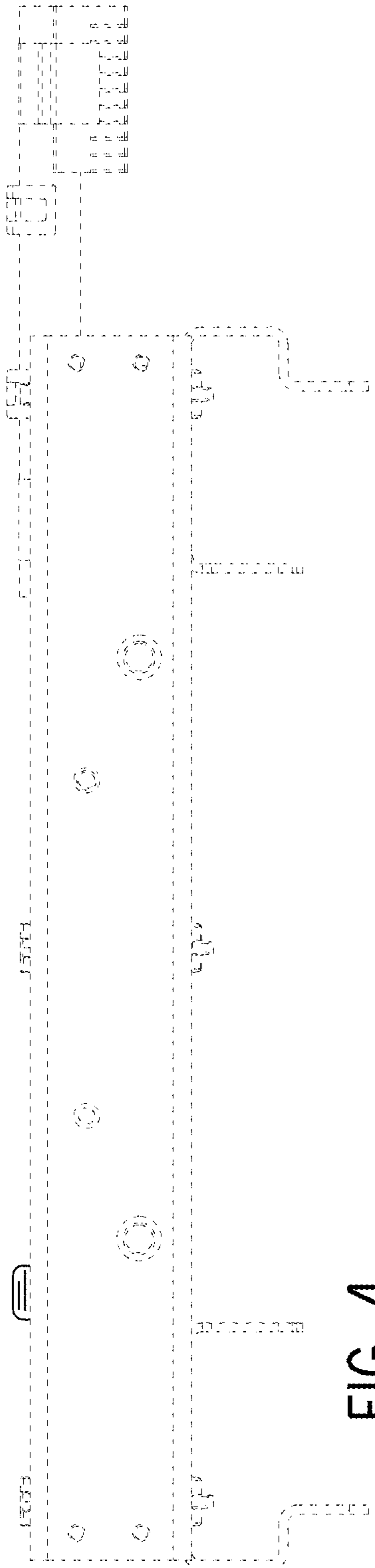

FIG. 4

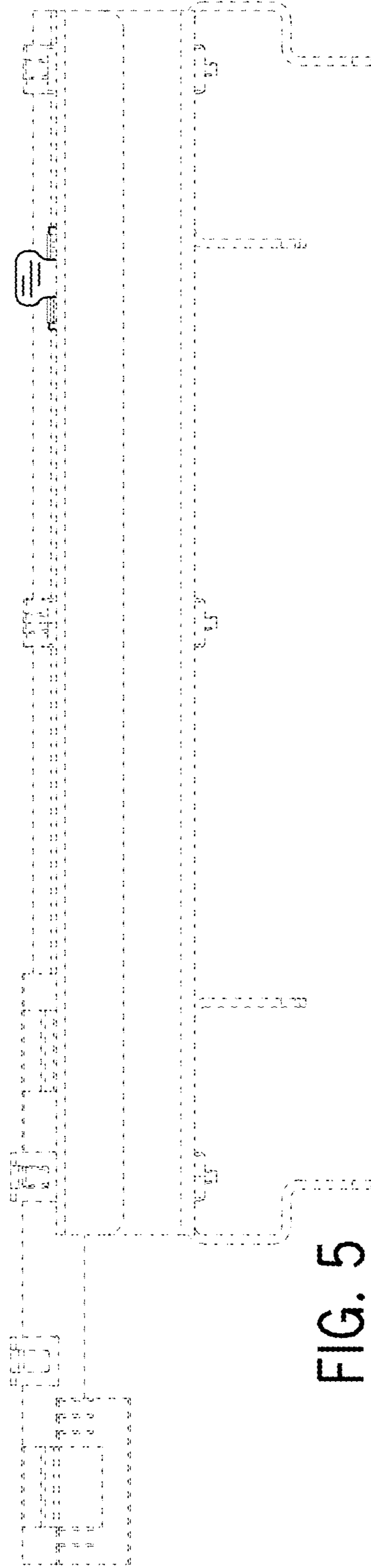

FIG. 5

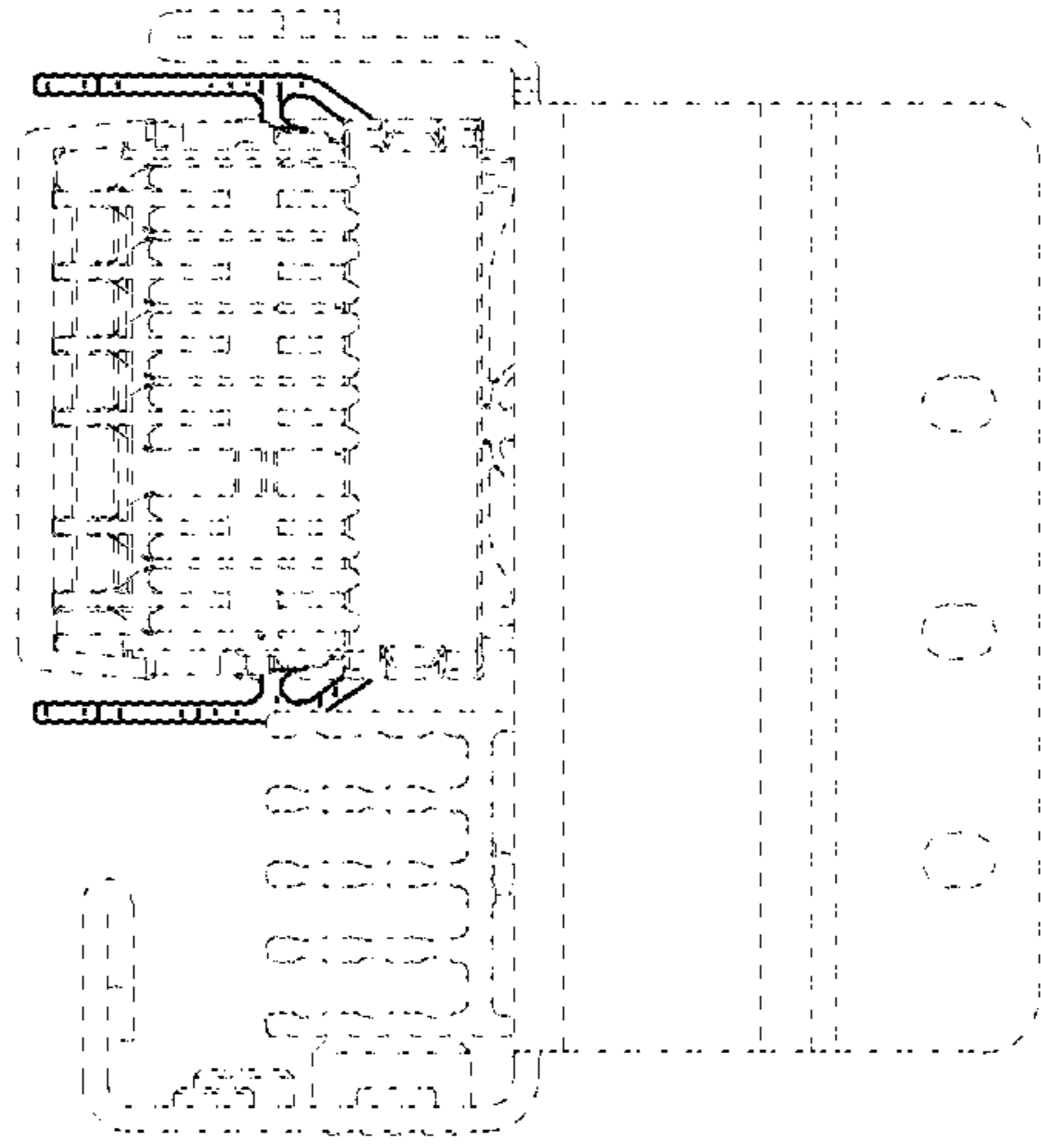

FIG. 6

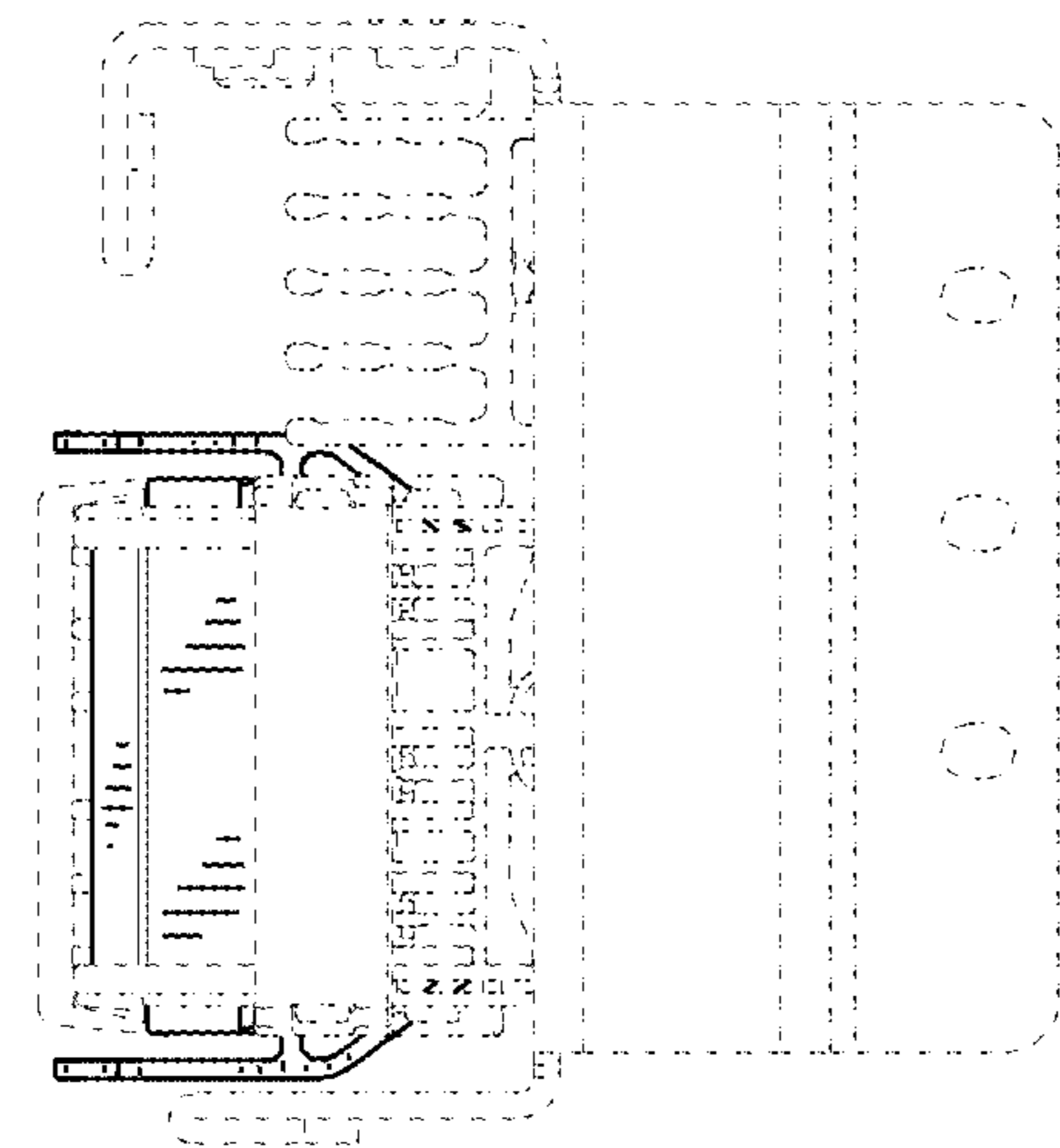

FIG. 7