



US00D831519S

(12) **United States Design Patent**
Monachon

(10) **Patent No.:** **US D831,519 S**
(45) **Date of Patent:** **** Oct. 23, 2018**

(54) **WATCH DIAL**
(71) Applicant: **OMEGA LTD.**, Biel/Bienne (CH)
(72) Inventor: **Jean-Claude Monachon**, Bevaix (CH)
(73) Assignee: **OMEGA LTD.**, Biel/Bienne (CH)
(**) Term: **15 Years**

D685,280 S * 7/2013 Muller D10/126
D688,580 S * 8/2013 Delhotal D10/124
D702,136 S * 4/2014 Monachon D10/39
D705,084 S * 5/2014 Emmenegger D10/32
D706,144 S * 6/2014 Monachon D10/39
D708,965 S * 7/2014 Monachon D10/39
D709,389 S * 7/2014 Monachon D10/39
D710,730 S * 8/2014 Delhotal D10/124
D722,901 S * 2/2015 Cerrato D10/126
D735,060 S * 7/2015 Monachon D10/32

(Continued)

(21) Appl. No.: **29/576,217**
(22) Filed: **Sep. 1, 2016**

(30) **Foreign Application Priority Data**

Mar. 1, 2016 (WO) DM/089 634

(51) **LOC (11) Cl.** **10-07**

(52) **U.S. Cl.**
USPC **D10/126**

(58) **Field of Classification Search**
USPC D10/30-39, 42, 122-124, 126, 128;
D11/3; D14/344; D99/28, 99; D24/167,
D24/186
See application file for complete search history.

(56) **References Cited**

U.S. PATENT DOCUMENTS

366,085 A * 7/1887 Fitch G04B 19/103
29/896.32
3,842,590 A * 10/1974 Kato G04B 19/25
368/319
D525,537 S * 7/2006 Monachon D10/32
D578,920 S * 10/2008 Behling D10/126
D584,171 S * 1/2009 Monachon D10/32
D619,916 S * 7/2010 Tedeschi D10/126
D638,734 S * 5/2011 Cole D10/126
D656,417 S * 3/2012 Monachon D10/39
D679,200 S * 4/2013 Jacquerye D10/39
D679,201 S * 4/2013 Jacquerye D10/39

OTHER PUBLICATIONS

U-Omega Seamaster Planet Ocean GMT | posted at ablogtowatch.com Mar. 2014 © 2007-2018 aBlogtoWatch [online][site visited Jun. 20, 2018]. Available from internet: <<https://www.ablogtowatch.com/omega-seamaster-planet-ocean-gmt-watch-review> (Year: 2014).*

(Continued)

Primary Examiner — Sandra S Snapp
Assistant Examiner — Katherine Glennon
(74) *Attorney, Agent, or Firm* — Abelman, Frayne & Schwab

(57) **CLAIM**

The ornamental design for a watch dial, as shown.

DESCRIPTION

FIG. 1 is a front right perspective view of a watch dial showing my new design;
FIG. 2 is a front view thereof;
FIG. 3 is a rear view thereof;
FIG. 4 is a left side view thereof;
FIG. 5 is a right side view thereof;
FIG. 6 is a top view thereof;
FIG. 7 is a bottom view thereof; and,
FIG. 8 is a rear right perspective view thereof.

1 Claim, 6 Drawing Sheets

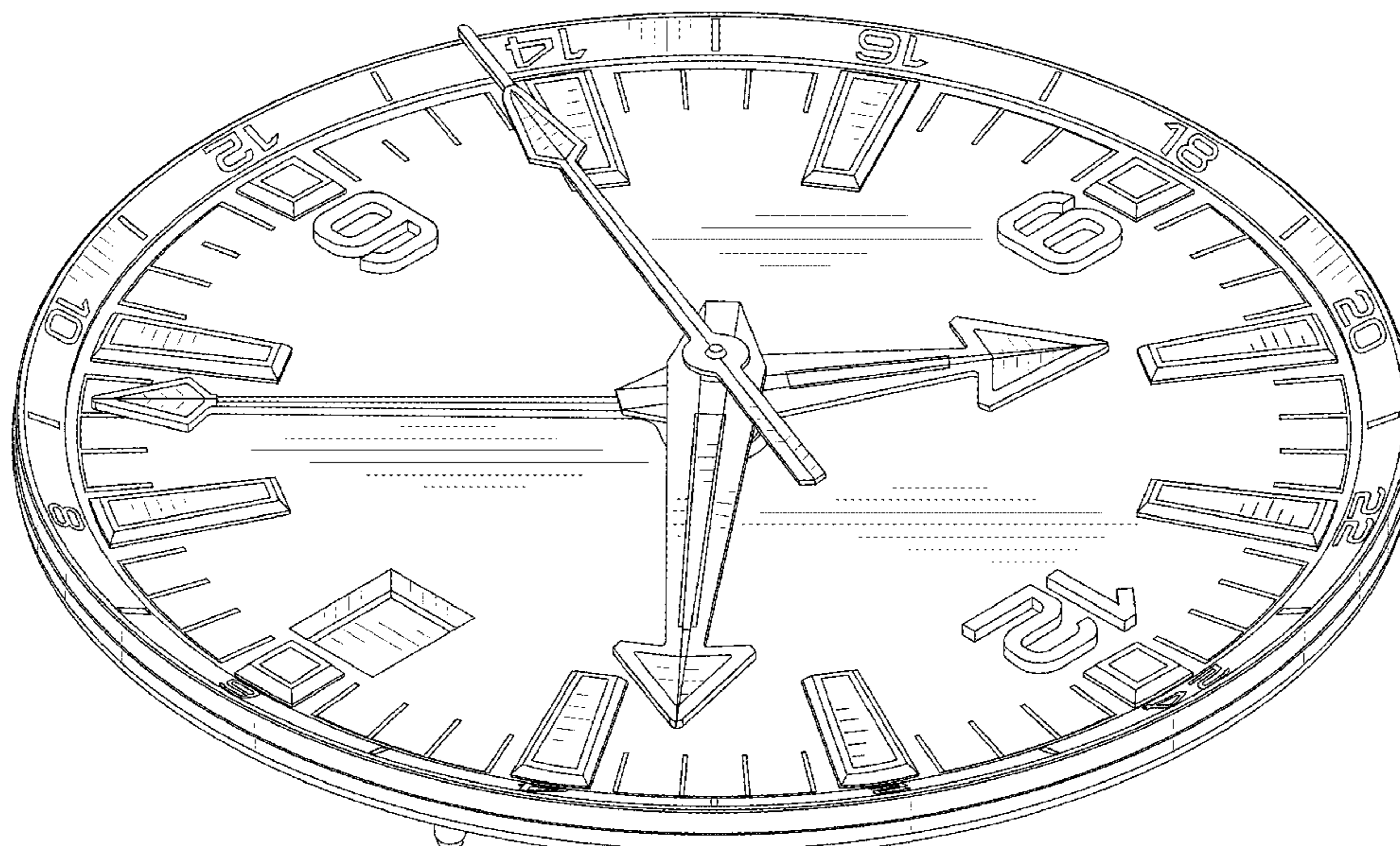

(56)

References Cited

U.S. PATENT DOCUMENTS

D760,105	S *	6/2016	Monachon	D10/124
D764,338	S *	8/2016	Cerrato	D10/127
D768,022	S *	10/2016	Monachon	D10/126
D768,526	S *	10/2016	Cerrato	D10/126
D768,527	S *	10/2016	Monachon	D10/126
D769,762	S *	10/2016	Behling	D10/126
D771,505	S *	11/2016	Cerrato	D10/30
D774,926	S *	12/2016	Butler	D10/38
D791,003	S *	7/2017	Ruffieux	D10/126
D792,247	S *	7/2017	Davoli	D10/30
D795,117	S *	8/2017	Monachon	D10/126
D820,139	S *	6/2018	Monachon	D10/126
2011/0063953	A1 *	3/2011	Hasegawa	G04C 3/143 368/80

OTHER PUBLICATIONS

V-Breitling Colt GMT Watch | posted at worldwatchreview.com Apr. 2010 [online][site visited Jun. 21, 2018]. Available from internet: <<https://www.worldwatchreview.com/2010/04/07/breitling-colt-gmt-diving-500/>> (Year: 2010).*

W-Breitling Navitimer A23322 Blue Dial | posted at chrono-shop.

net n.d.; vintage c. 2000. © 2013 Chrono Shop [online][site visited Jun. 22, 2018]. Available from internet: <<https://www.chrono-shop.net/en/breitling/8147-breitling-genuine-rare-watch-part-navitimer-a23322-blue-dial-chronograph.html>> (Year: 2000).*

Grand Seiko Hi-beat 36000 GMT | escapementmagazine.com Apr. 2014 © 2017 Escapement Magazine [online][site visited Jun. 21, 2018]. Available from internet: <<https://www.escapementmagazine.com/articles/grand-seiko-hi-beat-36000-gmt-limited-edition-sbgj005-in-depth-watch-review-by-escapement.html/>> (Year: 2014).*

Omega Seamaster Aqua Terra 15000 Gauss | posted at watchesbysjx.com Nov. 2013 SJX © 2011-2018 [online][site visited Mar. 13, 2018]. Available from Internet: <<http://watchesbysjx.com/2013/11/comparing-the-omega-seamaster-aqua-terra-15000-gauss-and-the-rolex-milgauss-116400gv-with-live-photos.html>> (Year: 2013).*

Omega Seamaster Planet Ocean 600m | posted at horbiter.com Sep. 2014 © TM Horbiter [online][site visited Jun. 20, 2018]. Available from Internet: <<https://www.horbiter.com/en/the-omega-seamaster-planet-ocean-600m-co-axial-gmt-titanium/>> (Year: 2014).*

The Omega Planet Ocean Deep Black Collecton | posted at hodinkee.com Jun. 15, 2016 © 2009-2018, Hodinkee Inc [online][site visited Jun. 20, 2018]. Available from internet: <<https://www.hodinkee.com/articles/the-omega-planet-ocean-deep-black-collection>> (Year: 2016).*

* cited by examiner

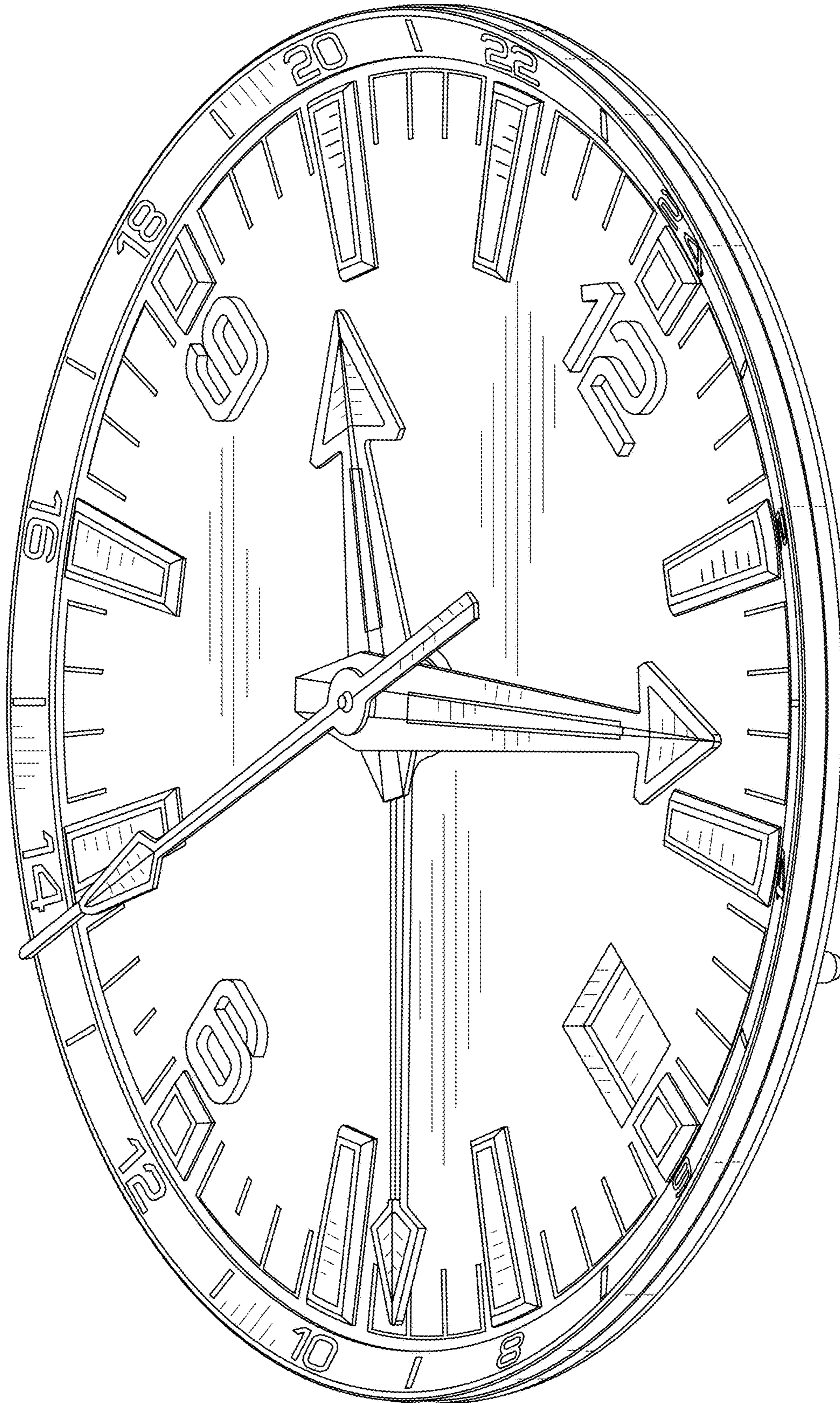

FIG. 1

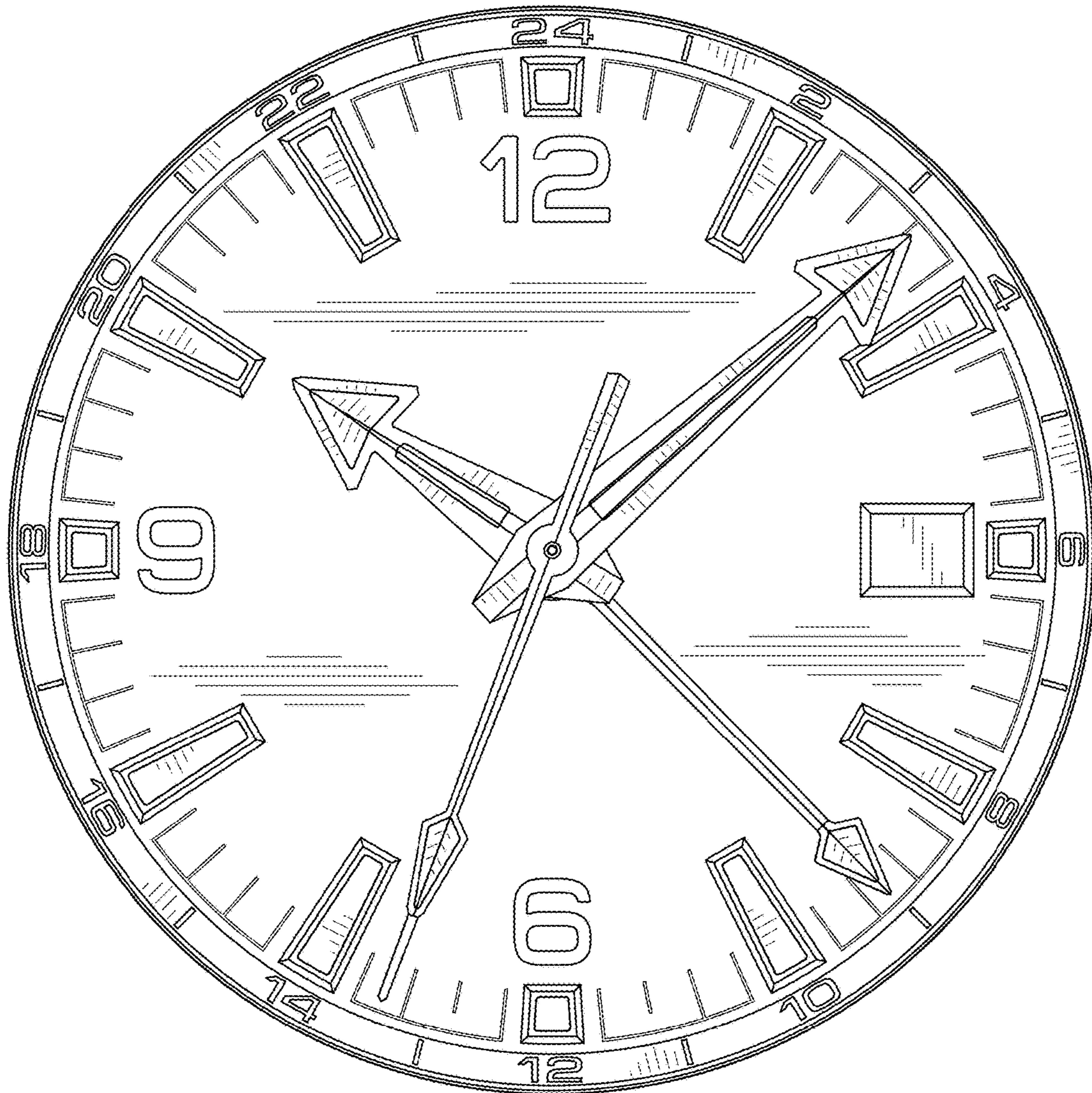

FIG. 2

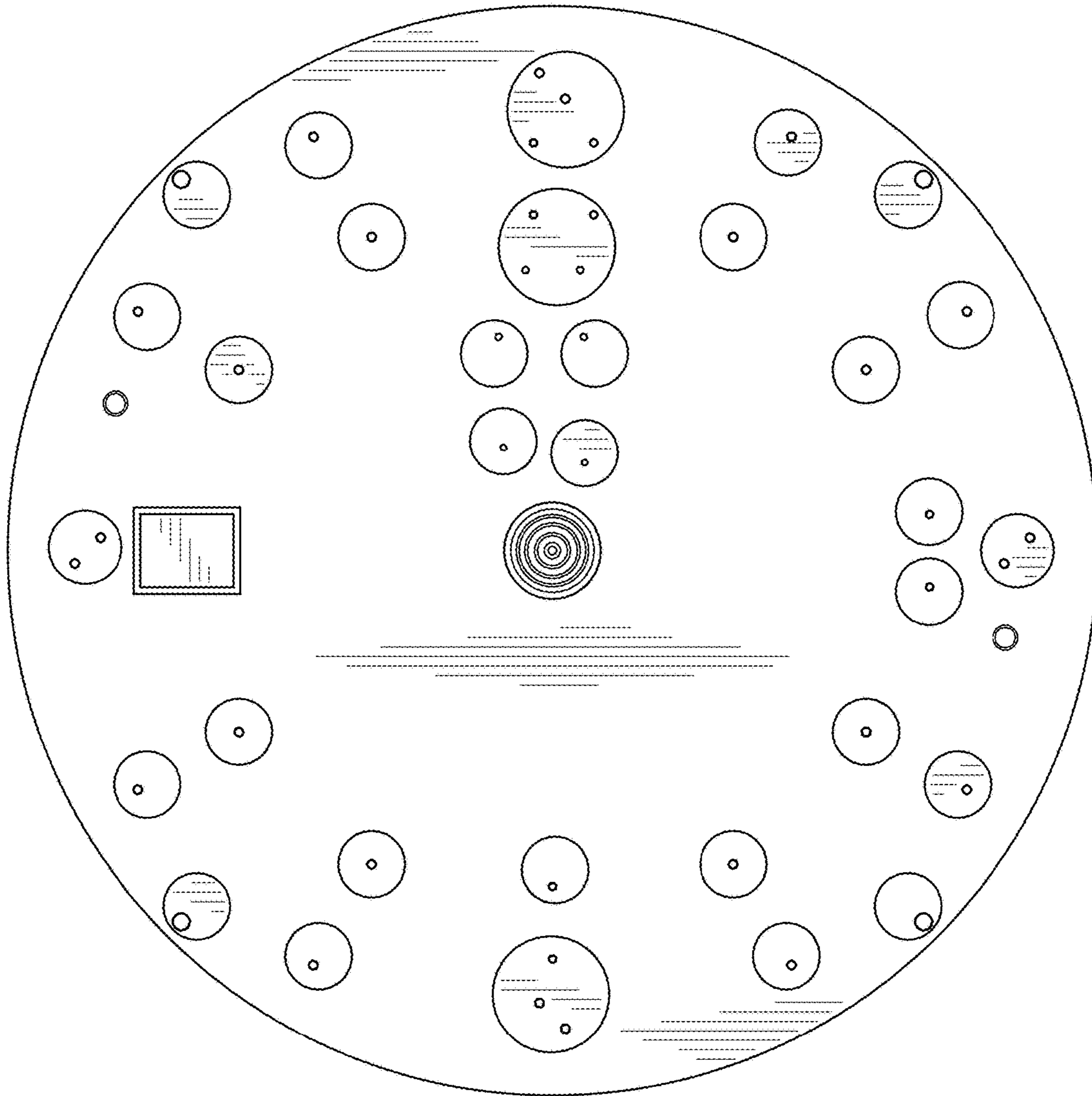

FIG. 3

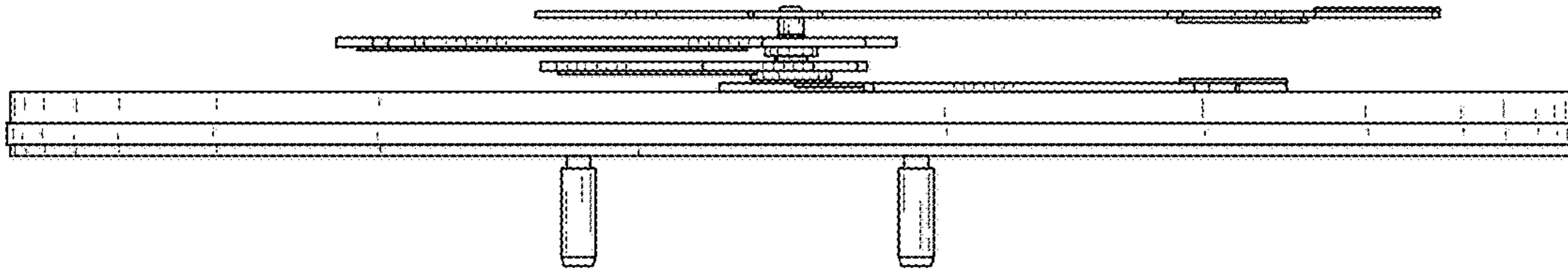

FIG. 4

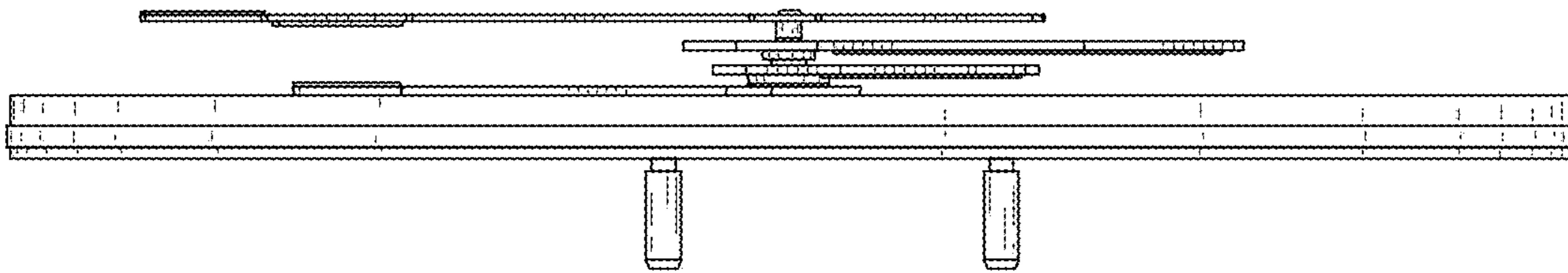

FIG. 5

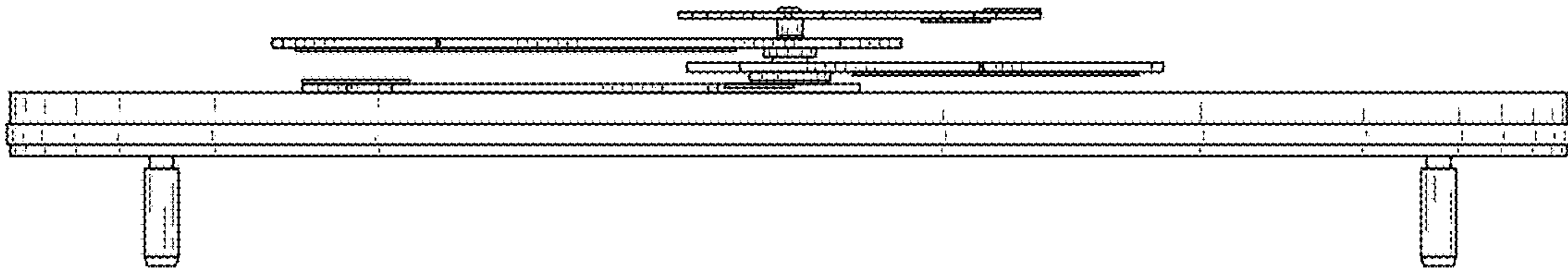

FIG. 6

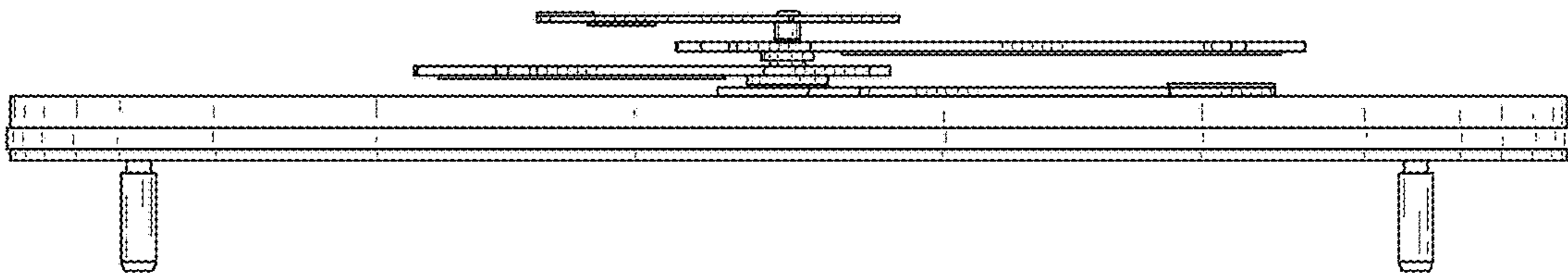

FIG. 7

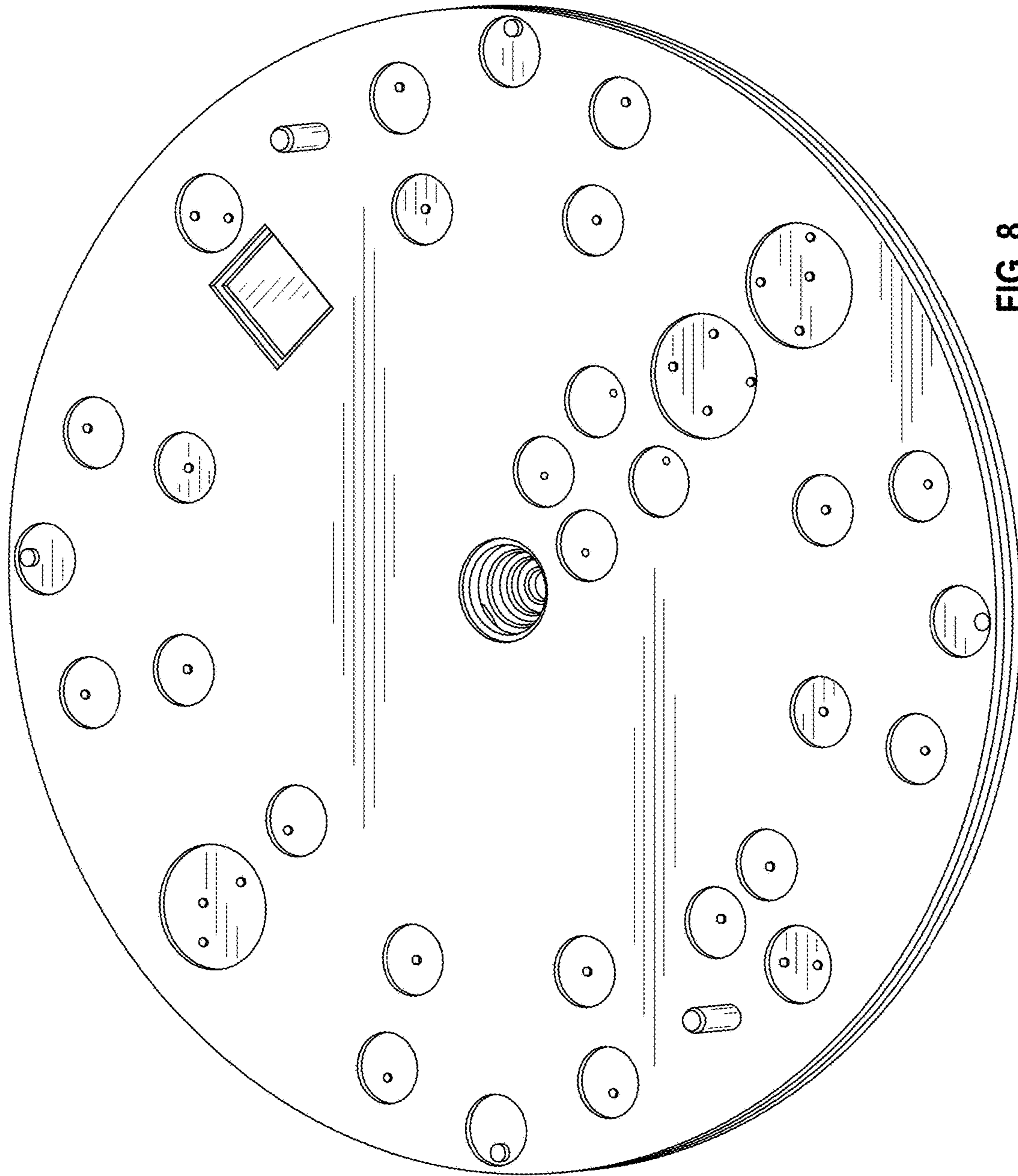

FIG. 8