

(56)

References Cited

U.S. PATENT DOCUMENTS

7,823,943 B2 * 11/2010 Borg B65D 71/50
294/87.2
7,861,853 B2 * 1/2011 Borg B65D 71/50
206/151
D653,560 S * 2/2012 Smithers D9/752
D700,526 S * 3/2014 Borg D9/752
D704,572 S * 5/2014 Borg D9/752
D721,598 S * 1/2015 Borg D9/752
9,517,859 B2 * 12/2016 Borg A47F 7/0071
D781,158 S * 3/2017 Bosworth D7/705
D786,702 S * 5/2017 Borg D9/752
2004/0134799 A1 * 7/2004 Mattson B65D 71/504
206/150
2007/0039836 A1 * 2/2007 Borg B65D 71/50
206/150
2007/0296231 A1 * 12/2007 Borg B65D 71/50
294/87.2
2010/0025360 A1 * 2/2010 Borg B65D 71/50
215/386

2012/0073997 A1 * 3/2012 Borg B65D 21/0206
206/150
2015/0210428 A1 * 7/2015 Borg A47F 7/0071
24/288
2018/0086524 A1 * 3/2018 Tetreault B65D 71/50

OTHER PUBLICATIONS

PakTech Handles, available Apr. 19, 2018, [online], [site visited Jul. 7, 2018]. Available from internet, <URL: <https://paktech-opi.com/>> (Year: 2018).*

Can Carrier (by PakTech via Dylan Macnab), available May 2013, [online], [site visited Jul. 7, 2018]. Available from internet, <URL: <http://cargocollective.com/dylanmacnab/CAN-CARRIER>> (Year: 2013).*

Plastic 4/6 pack PakTech “can holders” (via Beeradvocate), available Sep. 20, 2017, [online], [site visited Jul. 7, 2018]. Available from internet, <URL: <https://www.beeradvocate.com/community/threads/plastic-4-6-pack-paktech-can-holders.537476/>> (Year: 2017).*

* cited by examiner

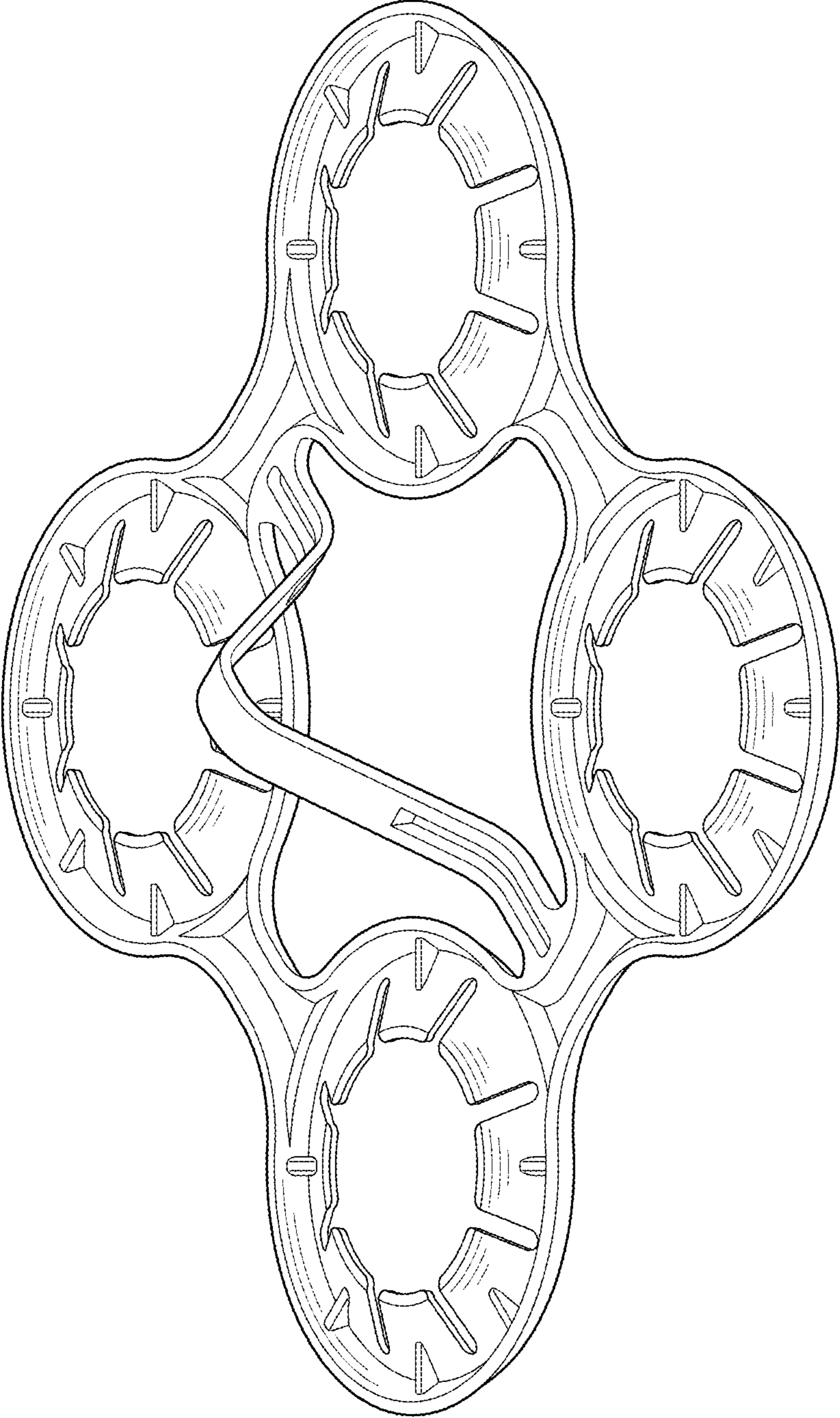

FIG. 1

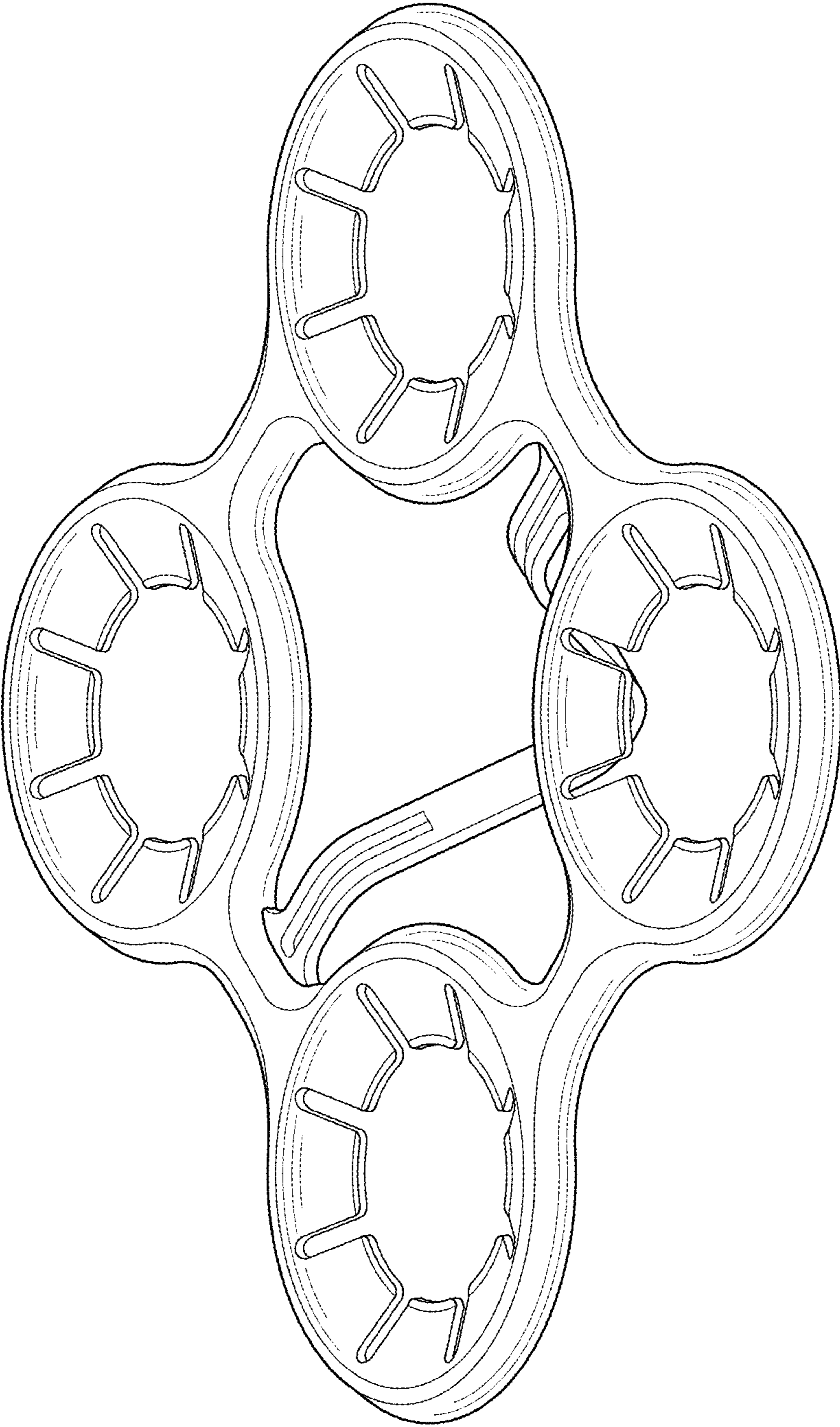

FIG. 2

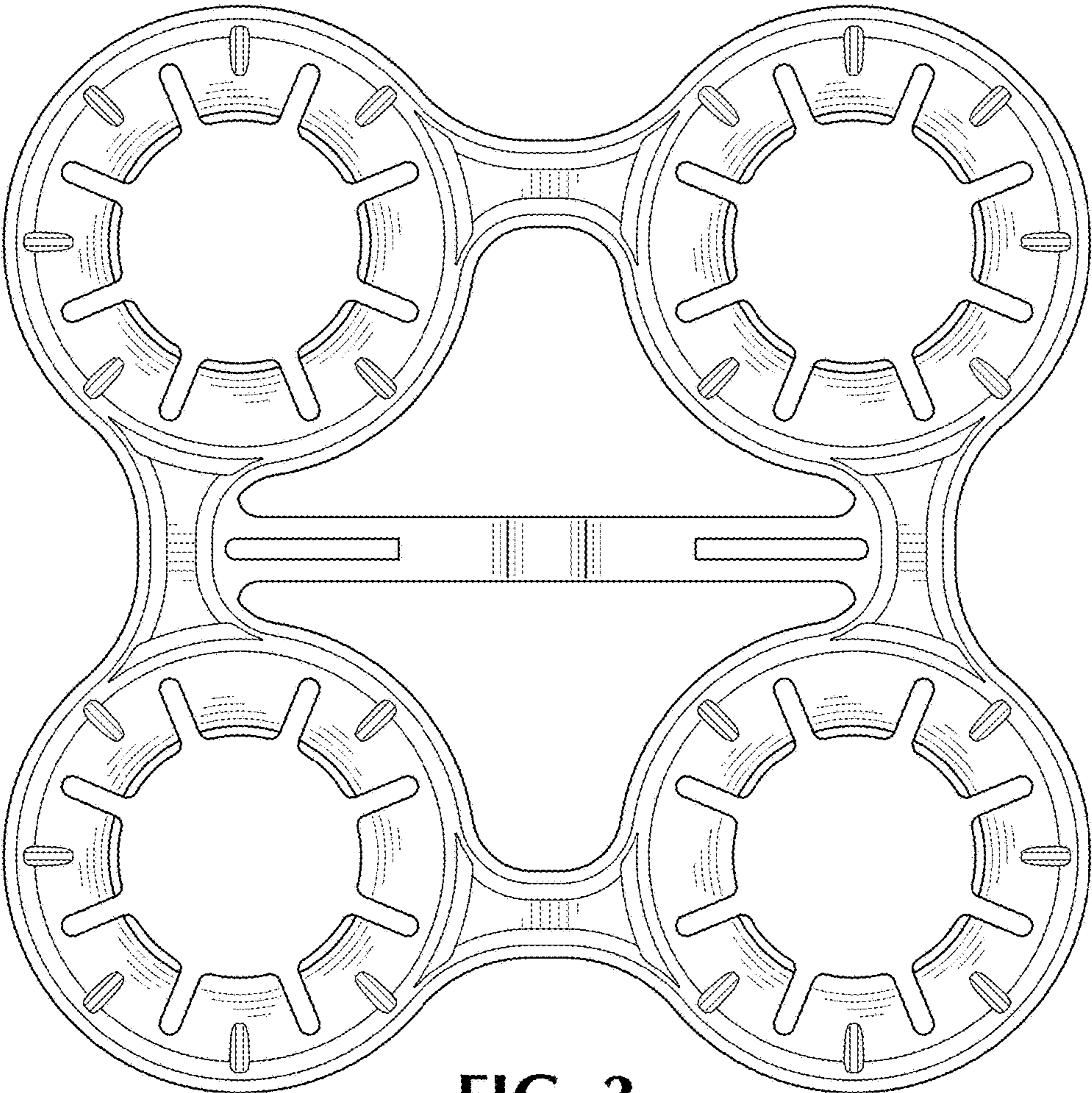

FIG. 3

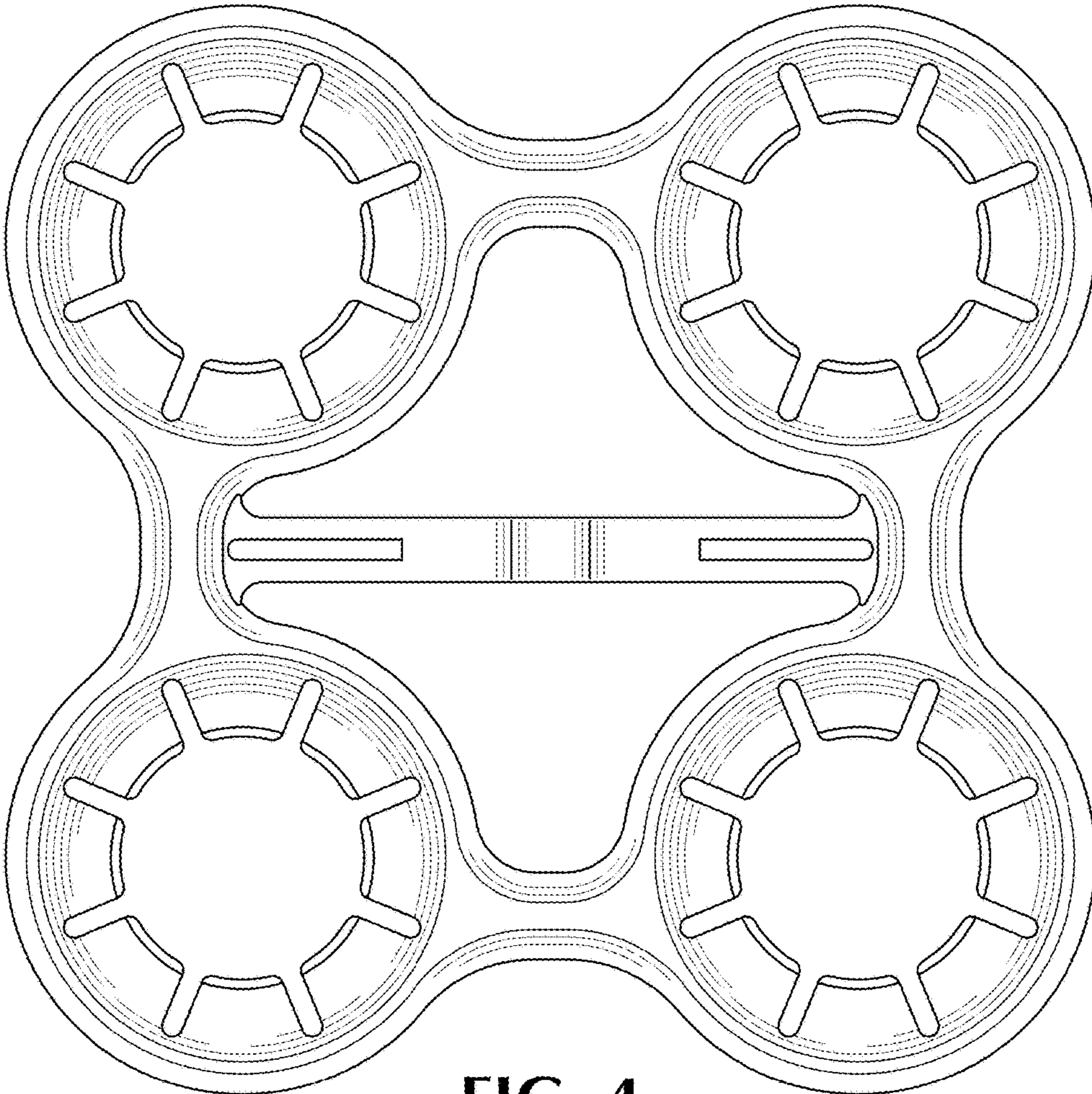

FIG. 4

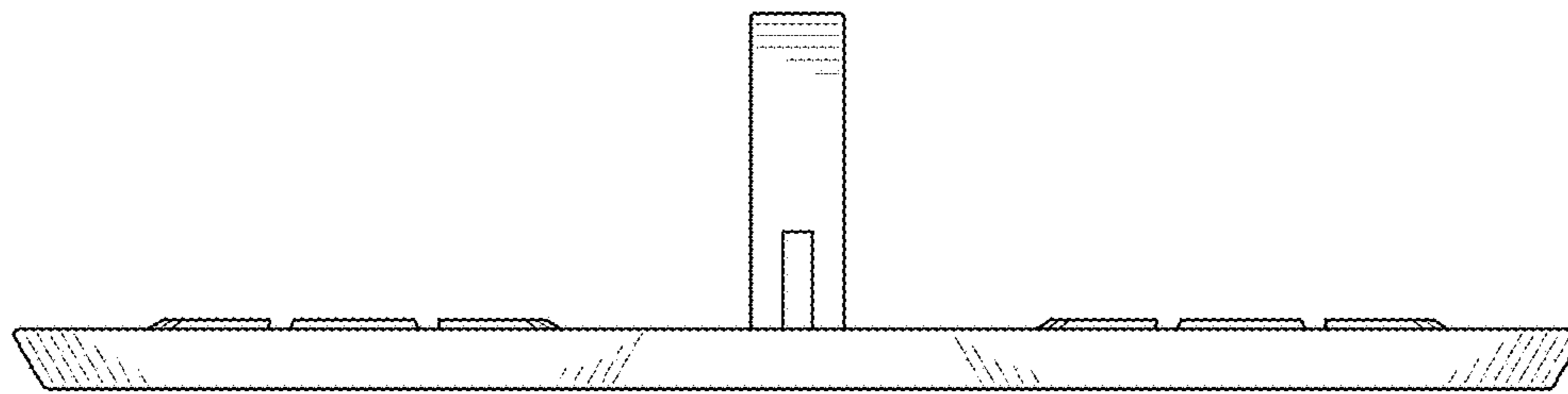

FIG. 5

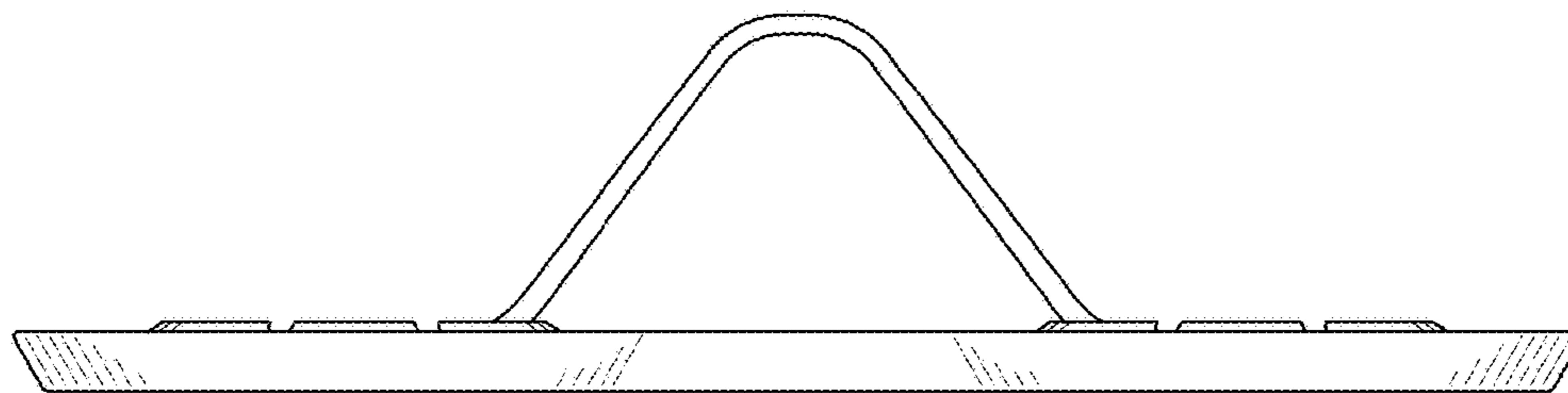

FIG. 6