



US00D831475S

(12) **United States Design Patent**
Sweeney et al.

(10) **Patent No.:** **US D831,475 S**
(45) **Date of Patent:** **** Oct. 23, 2018**

- (54) **DRILL TIP SCREW**
- (71) Applicant: **Spinal Generations, LLC**, Mokena, IL (US)
- (72) Inventors: **Patrick J. Sweeney**, Flossmoor, IL (US); **Matthew V. Leyden**, St. Paul, MN (US)
- (73) Assignee: **Spinal Generations, LLC**, Mokena, IL (US)
- (**) Term: **15 Years**

4,871,313	A	*	10/1989	Maillefer	A61C 5/35
						433/225
D358,212	S	*	5/1995	Sullivan	D24/156
D366,115	S	*	1/1996	Sullivan	D24/156
6,068,632	A	*	5/2000	Carchidi	A61B 17/1635
						433/165
D441,448	S	*	5/2001	Kumar	D24/156
D552,977	S	*	10/2007	He	D8/387
D583,946	S	*	12/2008	Schendel	D24/156
D611,511	S	*	3/2010	Anitua Aldecoa	D15/139
D773,926	S	*	12/2016	Sweeney	D8/387
D801,796	S	*	11/2017	Sweeney	D8/387
D803,038	S	*	11/2017	Baker	D8/387
2009/0003970	A1	*	1/2009	Griffith	F16B 25/0026
						411/485

(Continued)

- (21) Appl. No.: **29/589,786**
- (22) Filed: **Jan. 4, 2017**
- (51) **LOC (11) Cl.** **08-08**
- (52) **U.S. Cl.**
USPC **D8/387; D24/155**
- (58) **Field of Classification Search**
USPC D8/349, 382, 387, 388, 391, 393, 397,
D8/399; D24/155, 156, 157
CPC F16B 15/00; F16B 19/00; F16B 19/02;
F16B 23/00; F16B 23/0061; F16B
23/0007; F16B 23/0015; F16B 23/0069;
F16B 23/0084; F16B 25/0036; F16B
35/04; F16B 35/06; F16B 35/041; A61B
17/68; A61B 17/686; A61B 17/7083;
A61B 2017/0648; A61B 17/7082; A61B
17/8605; A61B 17/861; A61B 17/8877;
A61B 17/862; A61B 17/8883; A61B
17/8635
See application file for complete search history.

Primary Examiner — Sandra S Snapp
Assistant Examiner — Ieisha N Price
(74) *Attorney, Agent, or Firm* — Foley & Lardner LLP

(57) **CLAIM**

We claim the ornamental design for a drill tip screw, as shown and described.

DESCRIPTION

FIG. 1 is a top perspective view of the claimed design; FIG. 2 is a bottom perspective view of the claimed design of FIG. 1; FIG. 3 is a right side view of the claimed design of FIG. 1; FIG. 4 is a left side view of the claimed design of FIG. 1; FIG. 5 is a front elevation view of the claimed design of FIG. 1; FIG. 6 is a rear elevation view of the claimed design of FIG. 1; FIG. 7 is a top view of the claimed design of FIG. 1; and, FIG. 8 is a bottom view of the claimed design of FIG. 1. The ornamental design which is claimed is shown in solid lines in the drawings. The broken lines in the drawings are for illustrative purposes only and form no part of the claimed design.

(56) **References Cited**

U.S. PATENT DOCUMENTS

- D218,017 S * 7/1970 Brown 24/279
- D242,428 S * 11/1976 Stanley D8/338

1 Claim, 5 Drawing Sheets

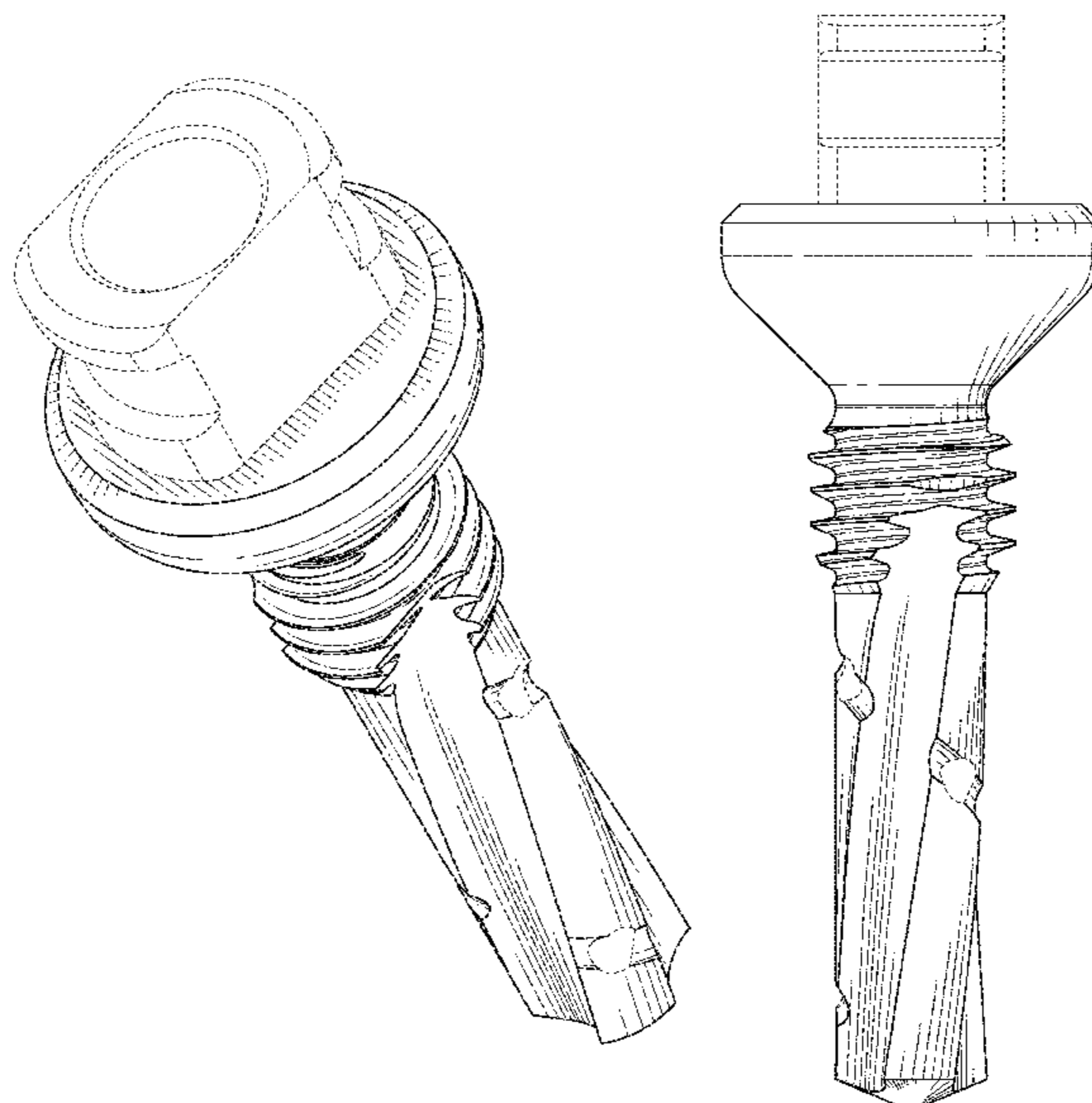

(56)

References Cited

U.S. PATENT DOCUMENTS

2011/0056166 A1* 3/2011 Bartlett E04G 9/04
52/742.14
2011/0257691 A1* 10/2011 Sutterlin A61B 17/862
606/305
2016/0278834 A1* 9/2016 Bayer A61B 17/863
2016/0281758 A1* 9/2016 Dagenais F16B 21/065
2017/0058520 A1* 3/2017 Keith E04C 2/2885

* cited by examiner

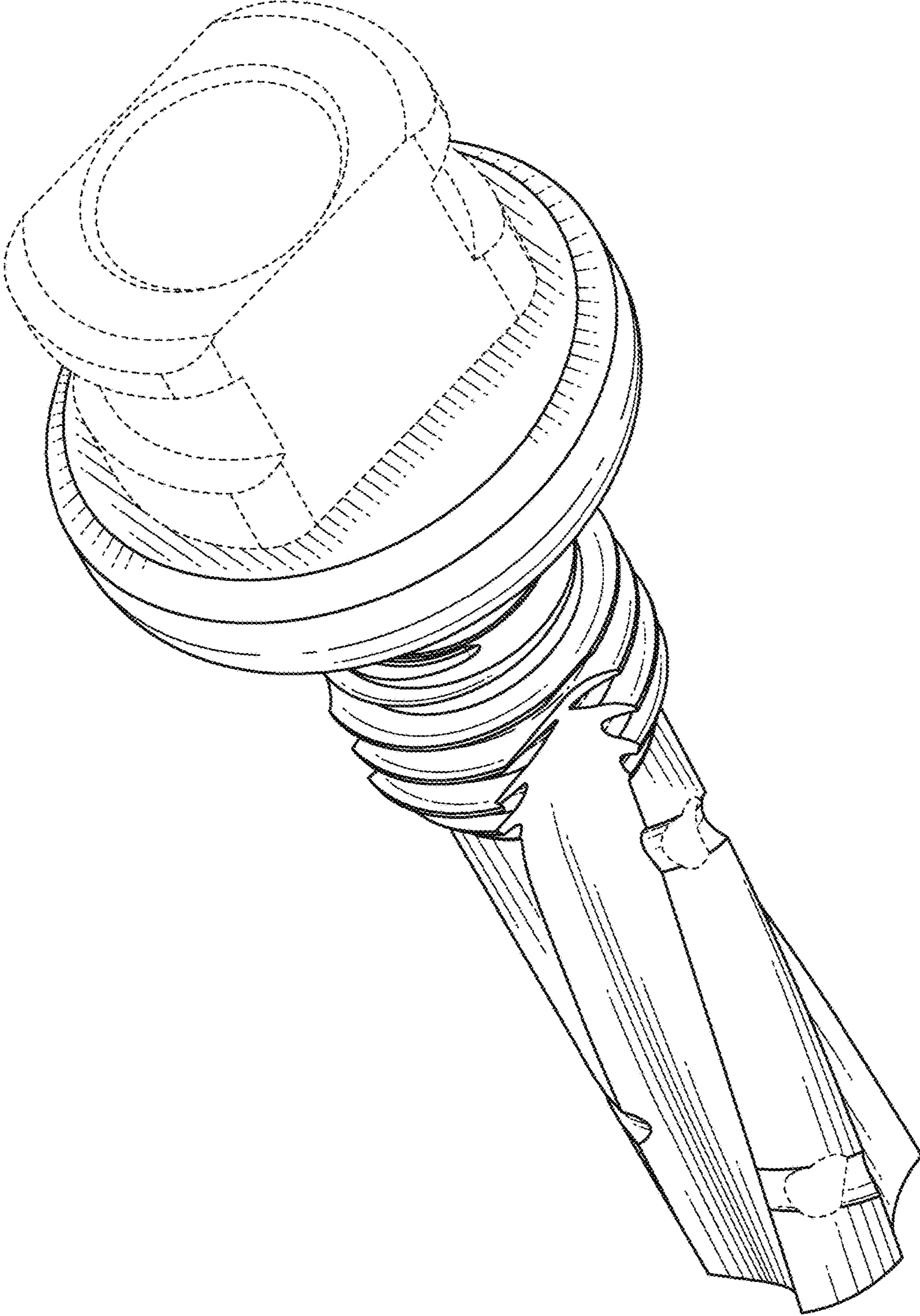

FIG. 1

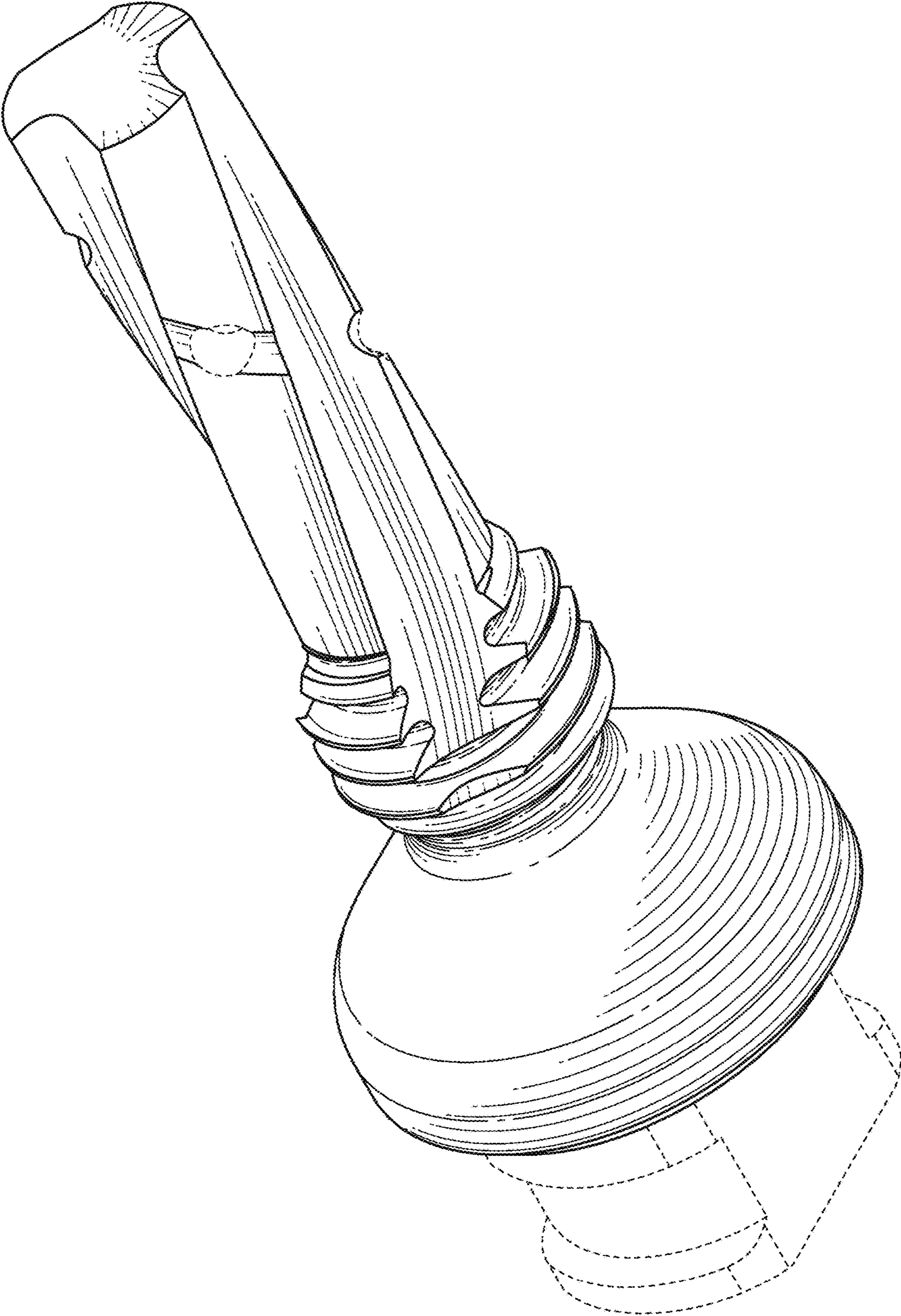

FIG. 2

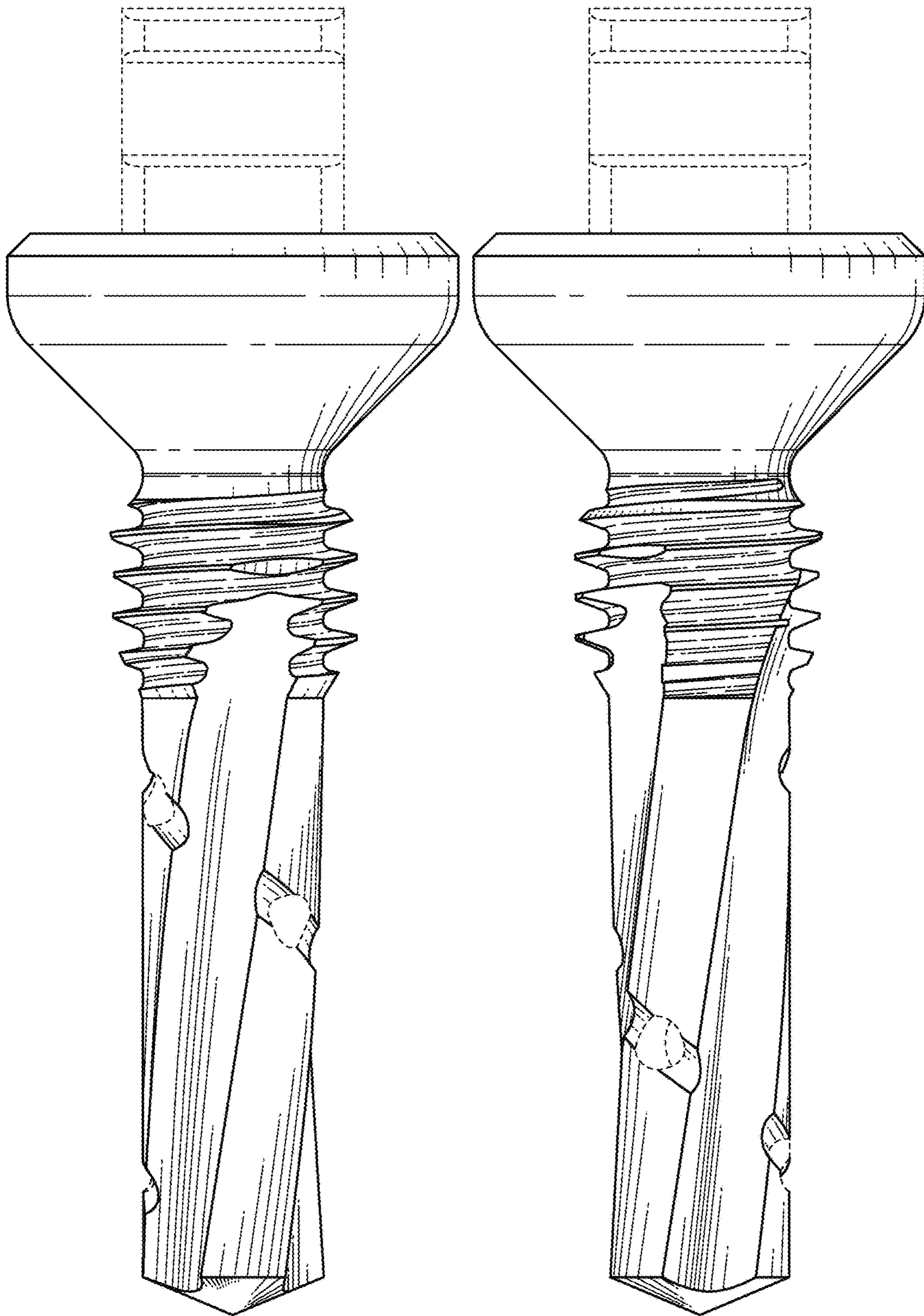

FIG. 3

FIG. 4

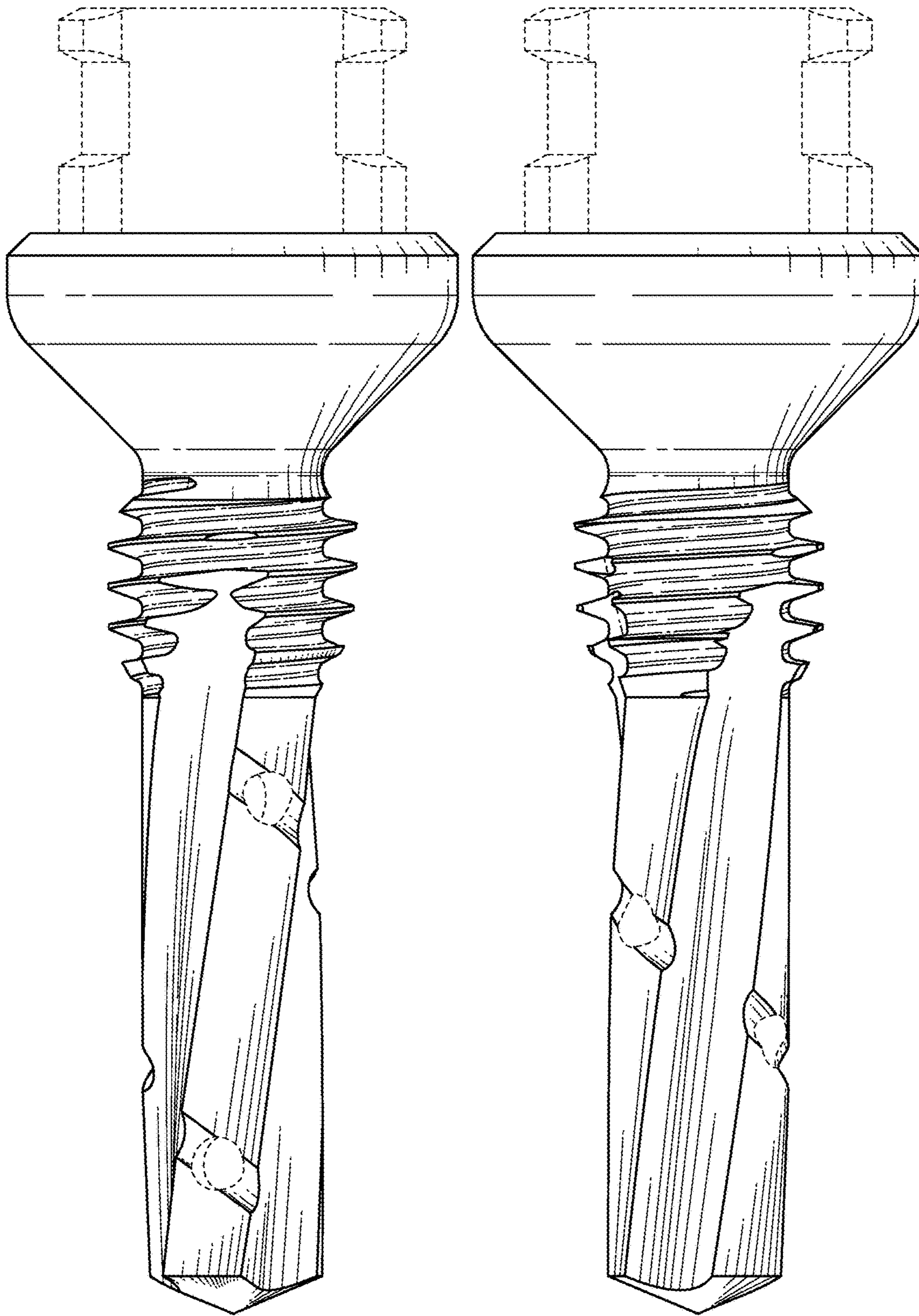

FIG. 5

FIG. 6

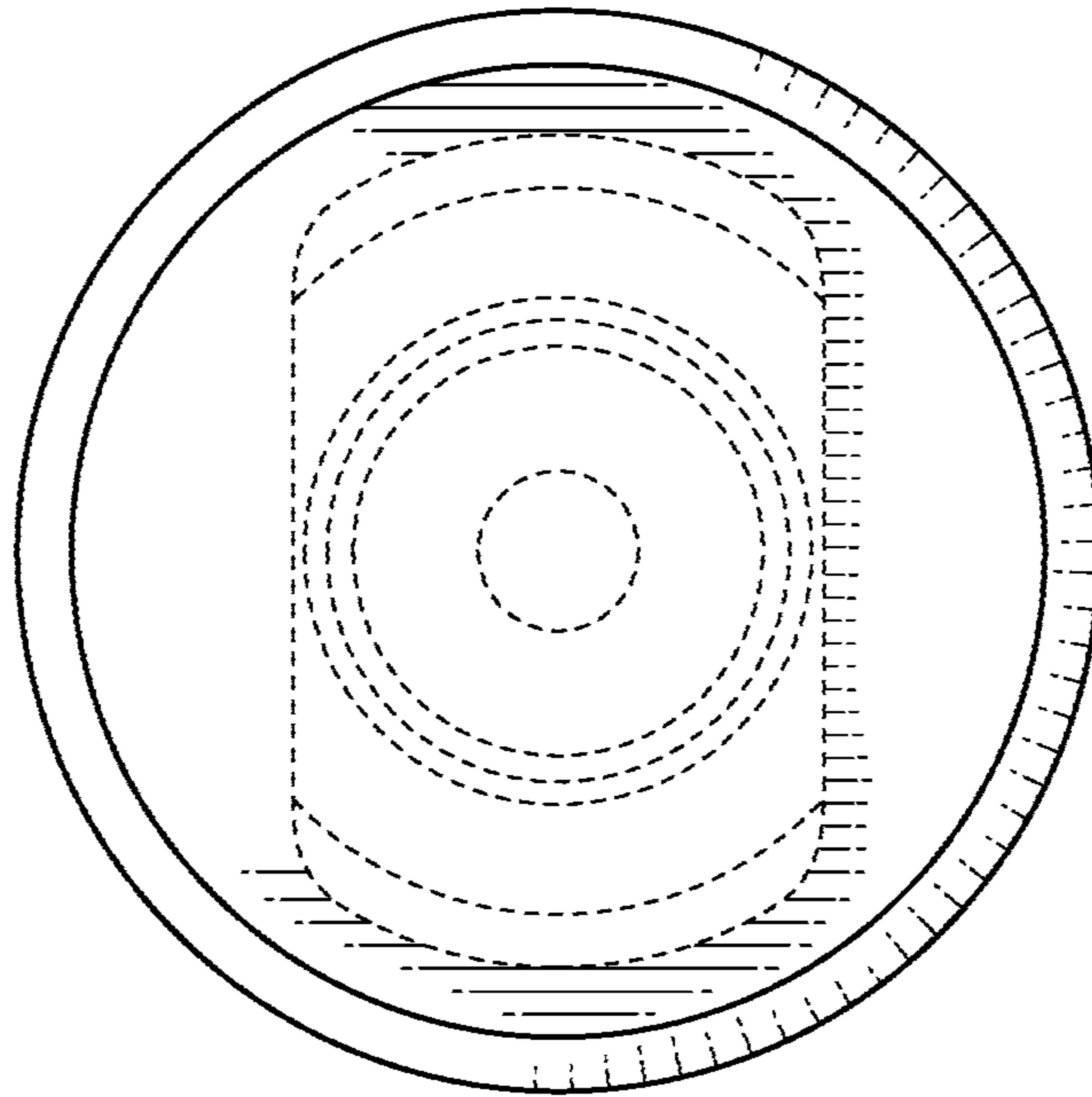

FIG. 7

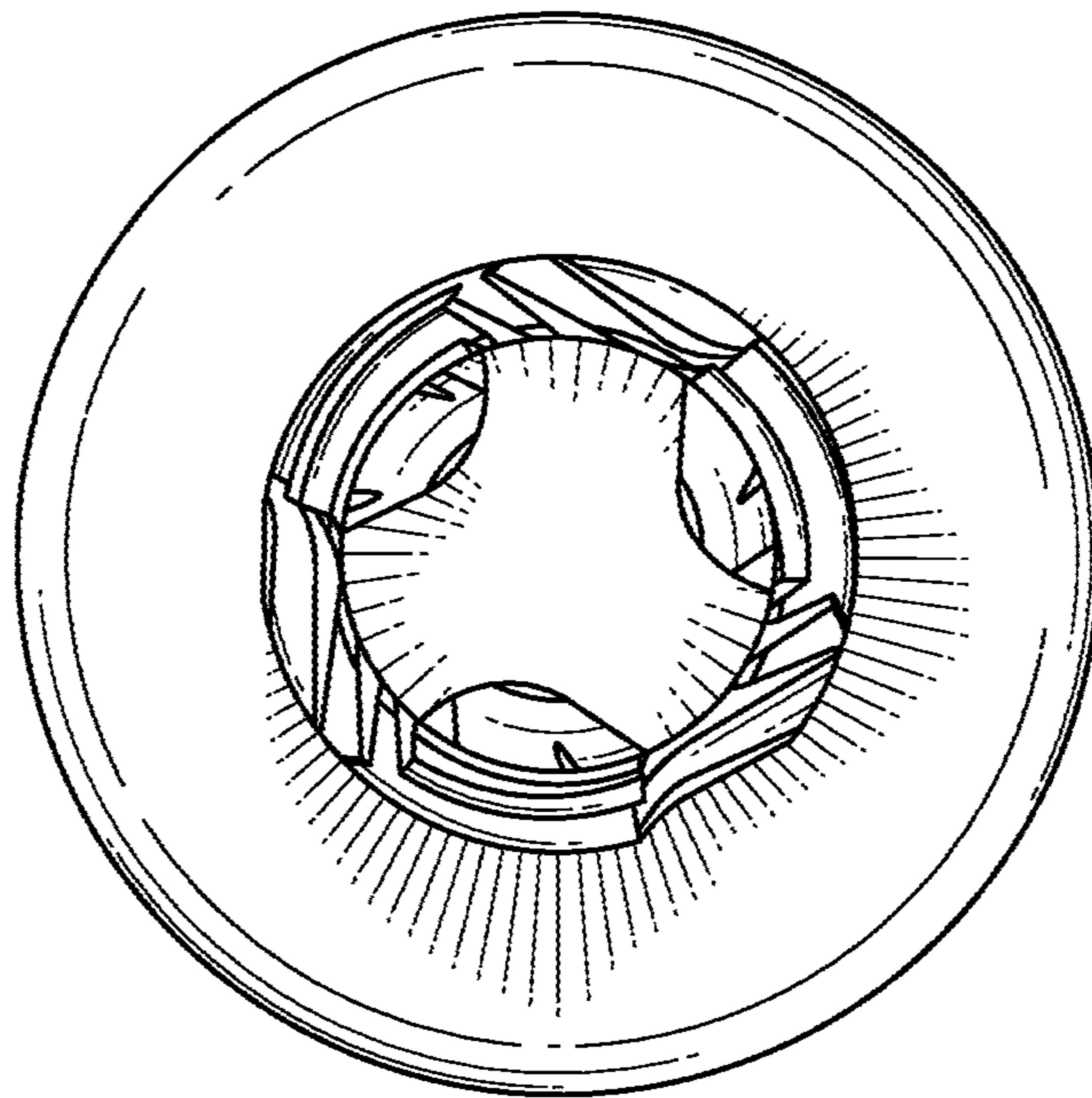

FIG. 8