



US00D831446S

(12) **United States Design Patent**
Beirach-Barak

(10) **Patent No.:** **US D831,446 S**

(45) **Date of Patent:** **** Oct. 23, 2018**

(54) **UNDERGROUND IRRIGATION DEVICE**

(71) Applicant: **Arie Beirach-Barak**, Tel-Aviv (IL)

(72) Inventor: **Arie Beirach-Barak**, Tel-Aviv (IL)

(**) Term: **15 Years**

(21) Appl. No.: **29/609,606**

(22) Filed: **Jul. 3, 2017**

(30) **Foreign Application Priority Data**

Feb. 13, 2017 (IL) 59957

(51) **LOC (11) Cl.** **08-01**

(52) **U.S. Cl.**
USPC **D8/1**

(58) **Field of Classification Search**
USPC D8/1; D23/259, 217; D10/52; D25/131
CPC E04H 12/2215; A01G 25/06; A01G 25/00;
A01G 29/00

See application file for complete search history.

(56) **References Cited**

U.S. PATENT DOCUMENTS

- 3,473,770 A * 10/1969 Edgerton B05B 15/622
248/87
- 4,432,291 A * 2/1984 Shirley A01G 25/06
111/7.1
- 4,870,781 A * 10/1989 Jones A01G 29/00
248/27.8

- D325,678 S * 4/1992 Niles D7/619.1
- D401,124 S * 11/1998 Rose D8/1
- D403,930 S * 1/1999 Gotoh D8/1
- D453,692 S * 2/2002 Addink D10/101
- D774,625 S * 12/2016 Boughton D23/217
- D778,410 S * 2/2017 Smith D23/259
- D783,132 S * 4/2017 Smith D23/259
- D797,904 S * 9/2017 Smith D23/259
- D816,439 S * 5/2018 Crook D8/1

* cited by examiner

Primary Examiner — Sheryl Lane

(74) *Attorney, Agent, or Firm* — Manelli Selter PLLC;
Edward J. Stemberger

(57) **CLAIM**

The ornamental design for an underground irrigation device, as shown.

DESCRIPTION

FIG. 1 is a front elevational view of an underground irrigation device in accordance with the invention; FIG. 2 is a right side elevational view thereof; the left side being a mirror image; FIG. 3 is a back elevational view thereof; FIG. 4 is a front perspective view thereof; FIG. 5 is a top plan view thereof; FIG. 6 is a bottom plan view thereof; and, FIG. 7 is a side perspective view thereof.

1 Claim, 7 Drawing Sheets

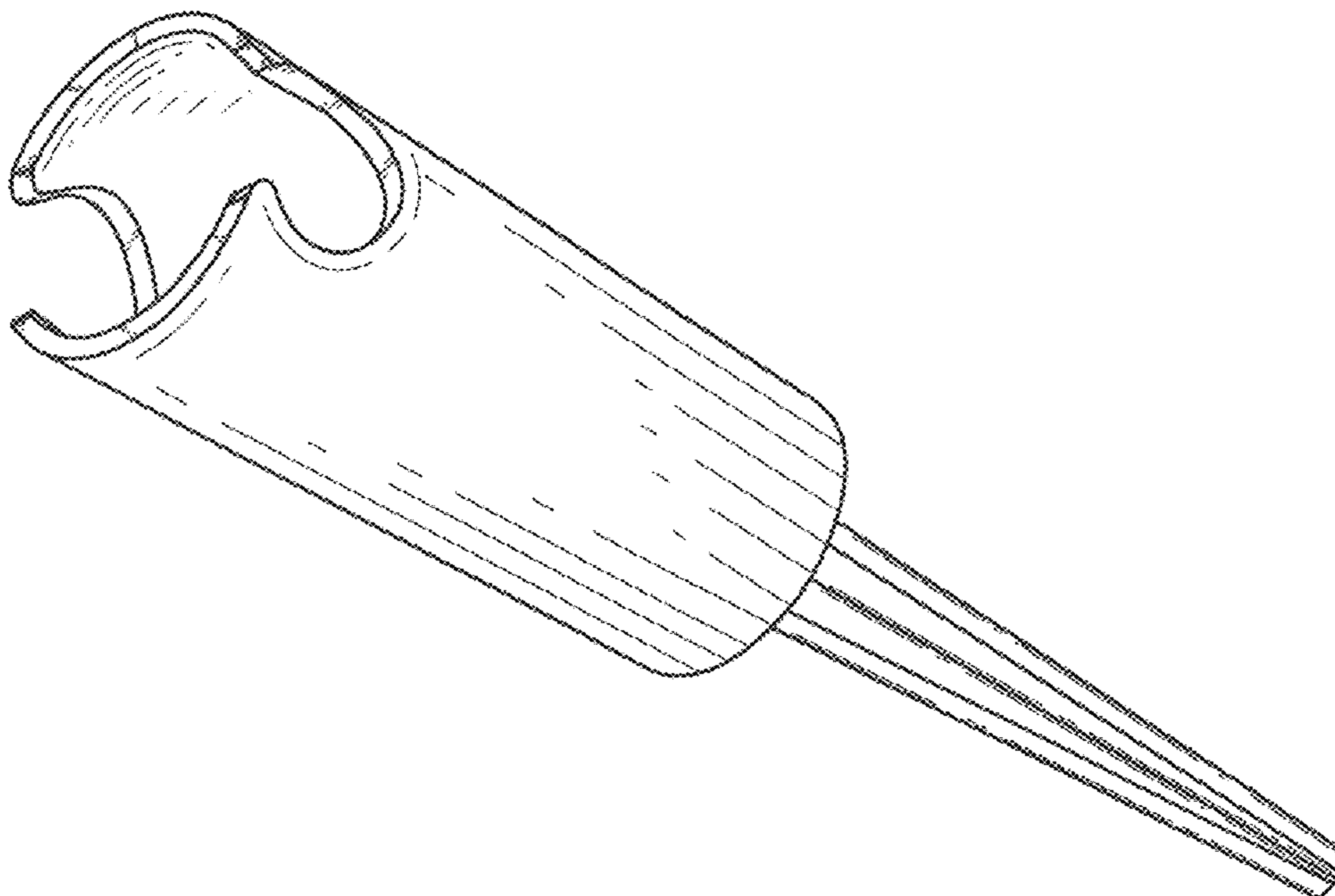

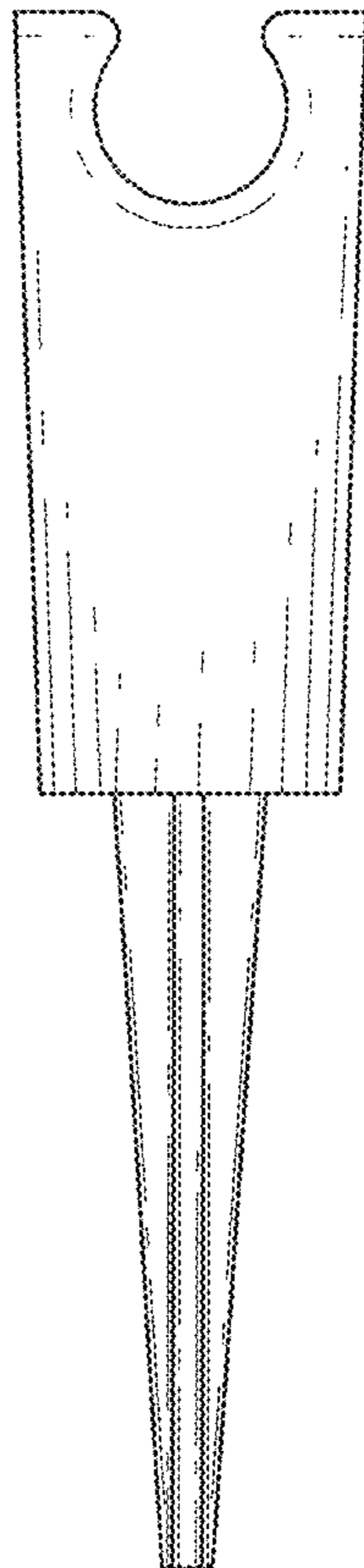

FIG. 1

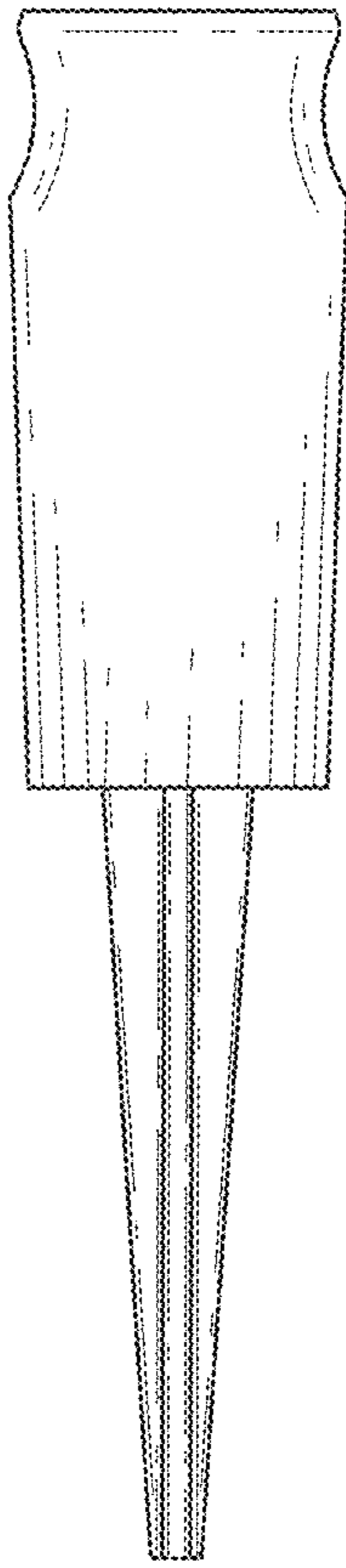

FIG. 2

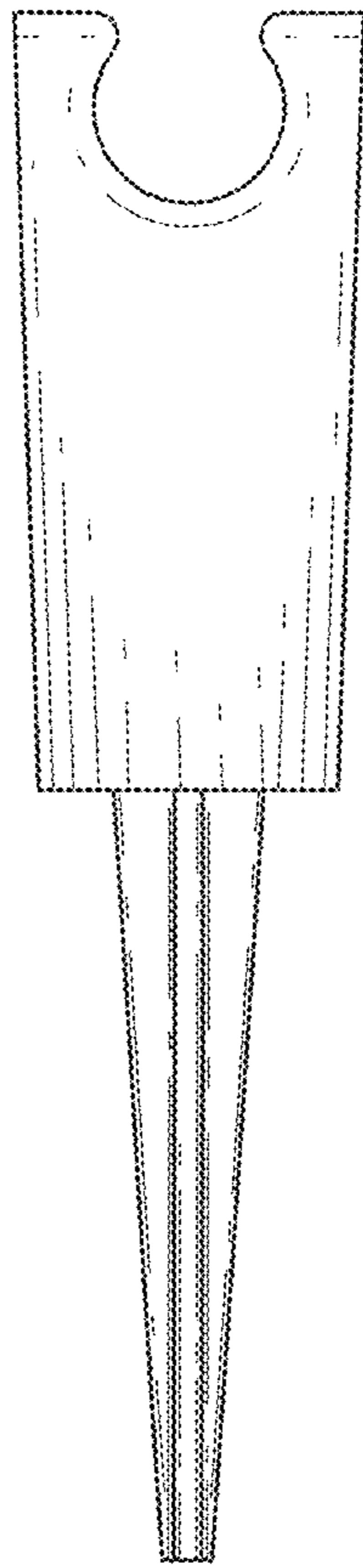

FIG. 3

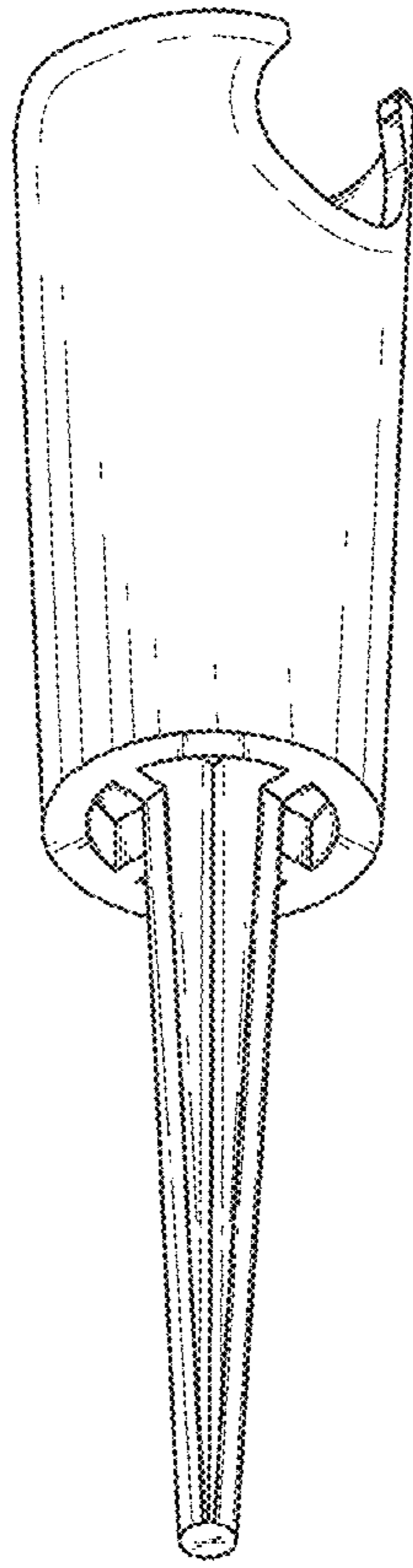

FIG. 4

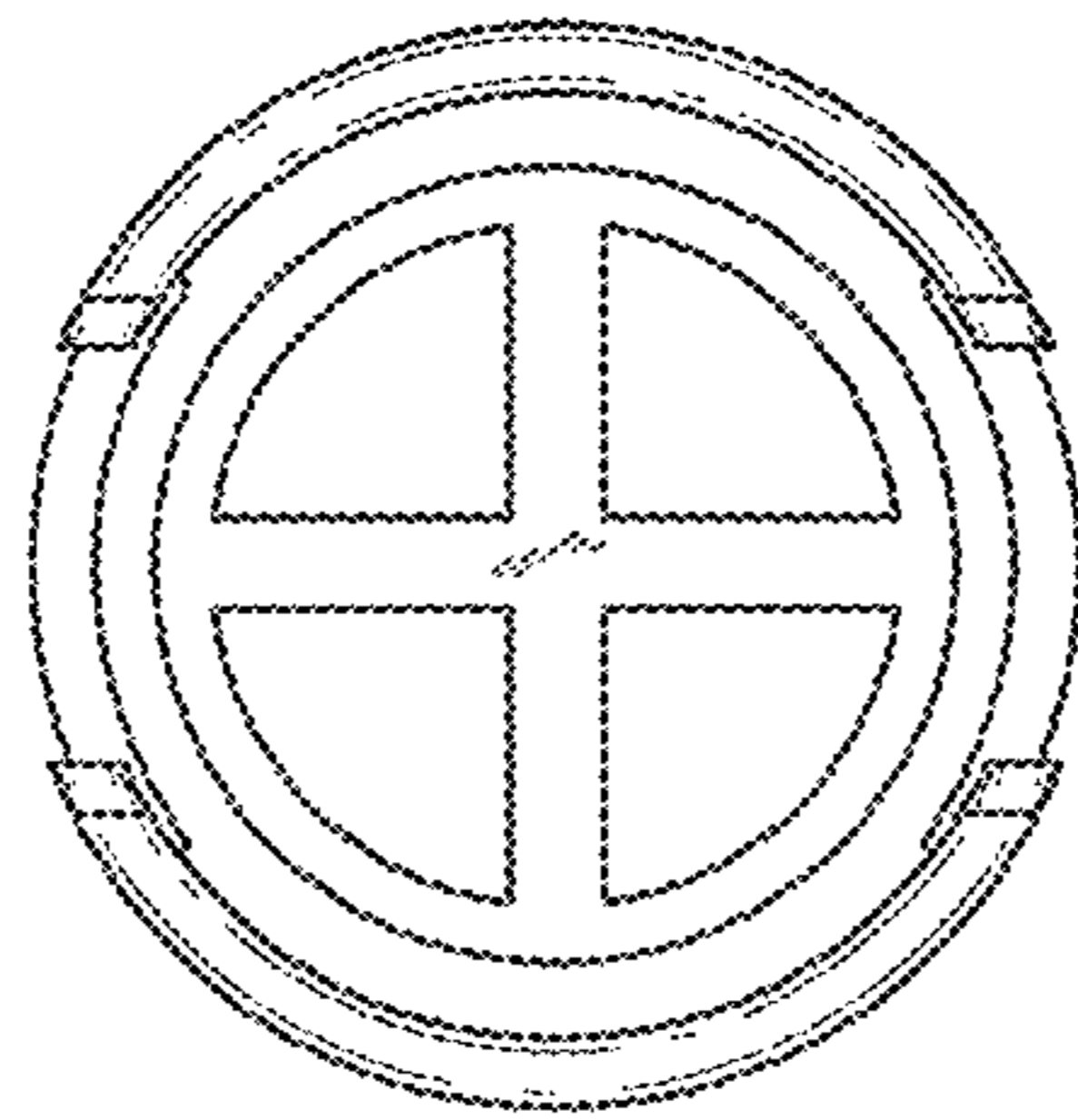

FIG. 5

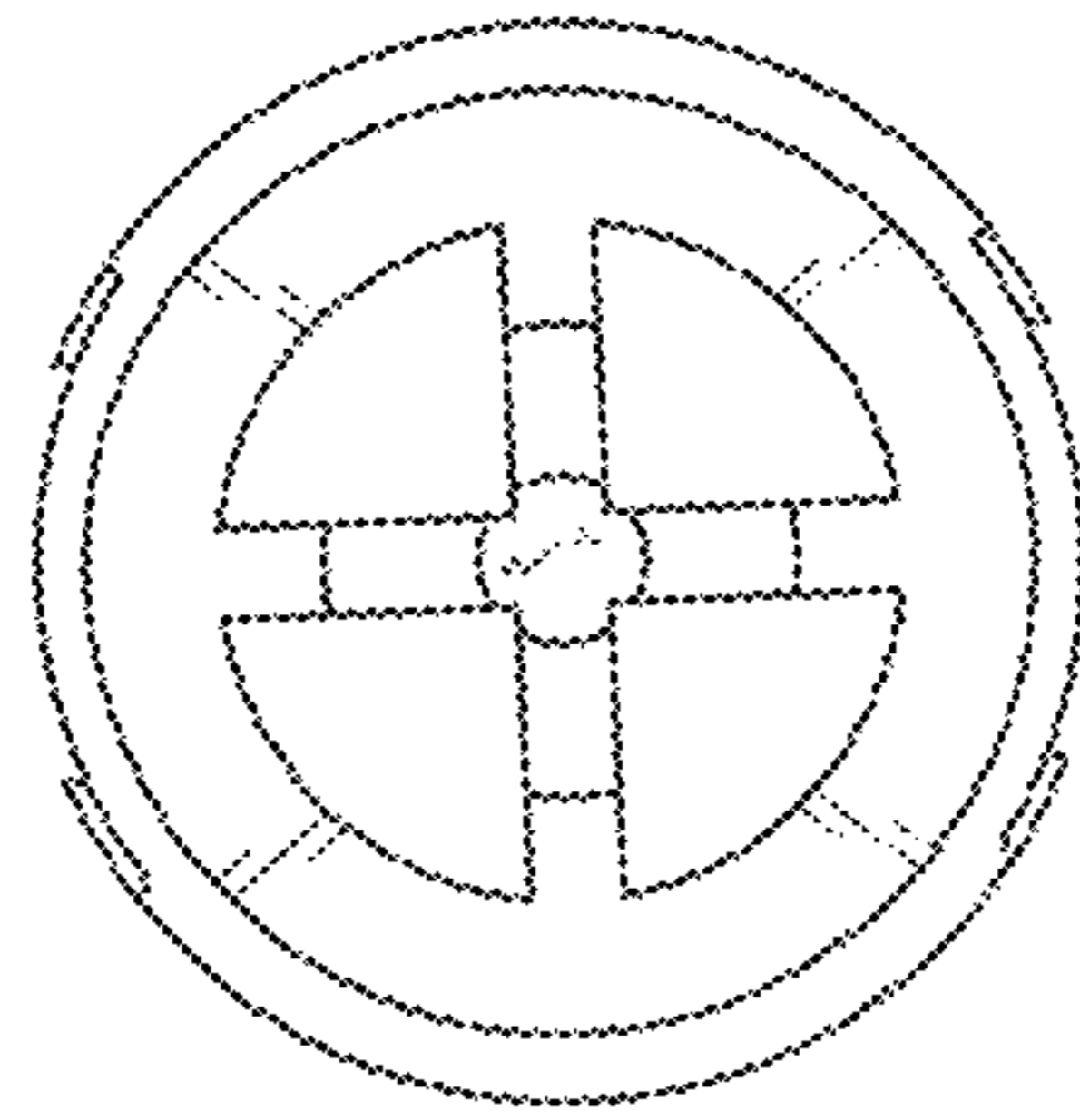

FIG. 6

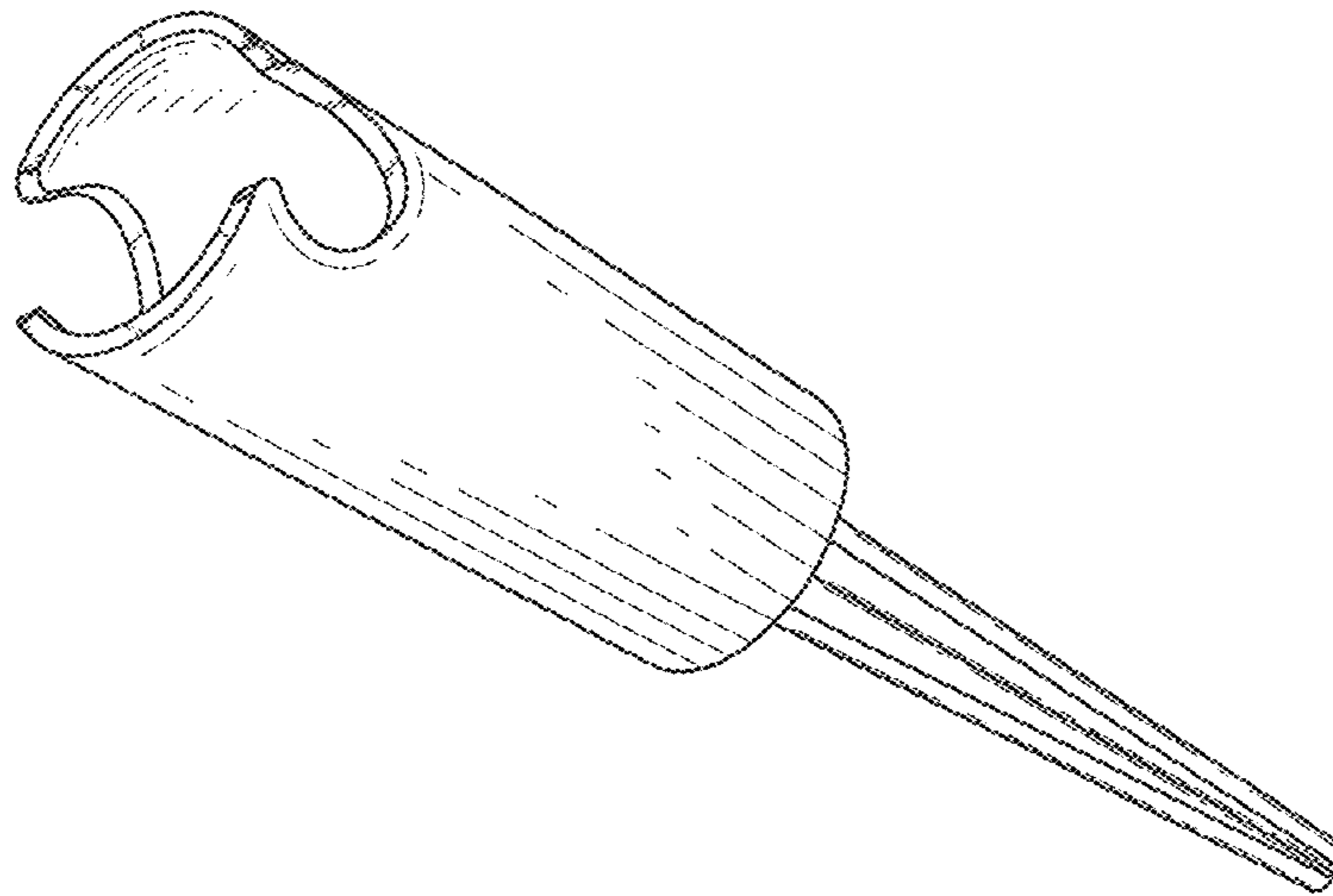

FIG. 7