



US00D831426S

(12) **United States Design Patent**
Best et al.

(10) **Patent No.:** **US D831,426 S**
(45) **Date of Patent:** **** Oct. 23, 2018**

(54) **COMBINATION BOTTLE AND CAP WITH L-SHAPED HANDLE**

(71) Applicant: **Can't Live Without It, LLC**, New York, NY (US)

(72) Inventors: **James Best**, Hewitt, NJ (US); **Clay Allen Burns**, New York, NY (US)

(73) Assignee: **CAN'T LIVE WITHOUT IT, LLC**, New York, NY (US)

(**) Term: **15 Years**

(21) Appl. No.: **29/621,885**

(22) Filed: **Oct. 12, 2017**

CPC B65D 39/00; B65D 39/16; B65D 42/00; B65D 42/02; B65D 43/32; B65D 43/02; B65D 43/16; B65D 43/22; B65D 43/26; B65D 45/04; B65D 50/00; B65D 50/02; B65D 51/005; B65D 51/007; B65D 51/14; B65D 51/145; B65D 51/18; B65D 51/28; B65D 51/16; B65D 51/242; B65D 51/243; B65D 51/2807; B65D 53/02; B65D 47/06; B65D 47/061; B65D 47/065; B65D 47/08; B65D 47/122; B65D 47/305; B65D 47/24; B65D 47/247; B65D 47/265; B65D 47/283; B65D 47/0866; B65D 47/0885; B65D 47/0871; B65D 47/0225; B65D 2543/00046; B65D 2543/00027; B65D 2543/00053; B65D 2543/00009; B65D 2539/00; B65D 41/00; B65D 41/02; B65D 41/04; B65D 41/0225; B65D 41/0233; B65D 41/06; B65D 41/12; B65D 23/108; B65D 23/001; B65D 35/46; B65D 81/3283; B65D 25/24; B65D 2251/0021; B65D 2251/0025; B65D 2251/0028; B65D 2251/0081; B65D 2251/0087; B65D 2251/009; B65D 2543/00231; A47G 19/00; A47G 19/22; A47G 19/2205; A47G 19/2272; A47G 19/2266; A47G 19/2288; A47G 21/18; A47J 43/1087; A47J 43/27

Related U.S. Application Data

(62) Division of application No. 29/596,858, filed on Mar. 10, 2017, now Pat. No. Des. 809,384.

(51) **LOC (11) Cl.** **07-01**

(52) **U.S. Cl.**

USPC **D7/511**; D9/516

(58) **Field of Classification Search**

USPC D3/202, 203.1, 203.2, 215, 273, 275, D3/291, 294, 318; D7/300-305, 312, D7/317, 321, 322, 392.1, 396.2, 500, 505, D7/507, 509, 510, 511, 513, 523, 533, D7/536, 538, 586, 601, 602, 608, 619.1, D7/629, 313, 314, 387, 388, 391, 392, D7/393, 394, 395, 396.1, 397, 398, 403, D7/514, 624.1, 900; D9/418, 434-440, D9/443-450, 500, 502, 503, 505, 516, D9/523-527, 528, 529, 530, 531, 534, D9/536, 537, 538, 544, 545, 546, 549, D9/550, 563, 682, 686, 688, 715, 719, D9/738, 451, 453, 455, 452, 454, 774; D19/70, 71, 115, 162, 163, 165, 192, D19/194; D24/121, 127, 197, 224, 108, D24/112, 120, 129, 162, 194, 216; D23/206, 255, 259, 260

See application file for complete search history.

(56)

References Cited

U.S. PATENT DOCUMENTS

321,236 A * 6/1885 Morgan B65D 45/24 215/280
358,189 A * 2/1887 Denebeim B65D 55/06 215/278
1,338,494 A 4/1920 Daniel
1,421,118 A 6/1922 Anderson
1,669,216 A 5/1928 Stanley
1,723,260 A 8/1929 Thomssen
2,169,448 A 8/1939 Linch
D149,834 S 6/1948 Perkins
3,000,527 A 9/1961 Jennings et al.
3,311,252 A 3/1967 Swartwood et al.
3,412,887 A 11/1968 Swartwood et al.

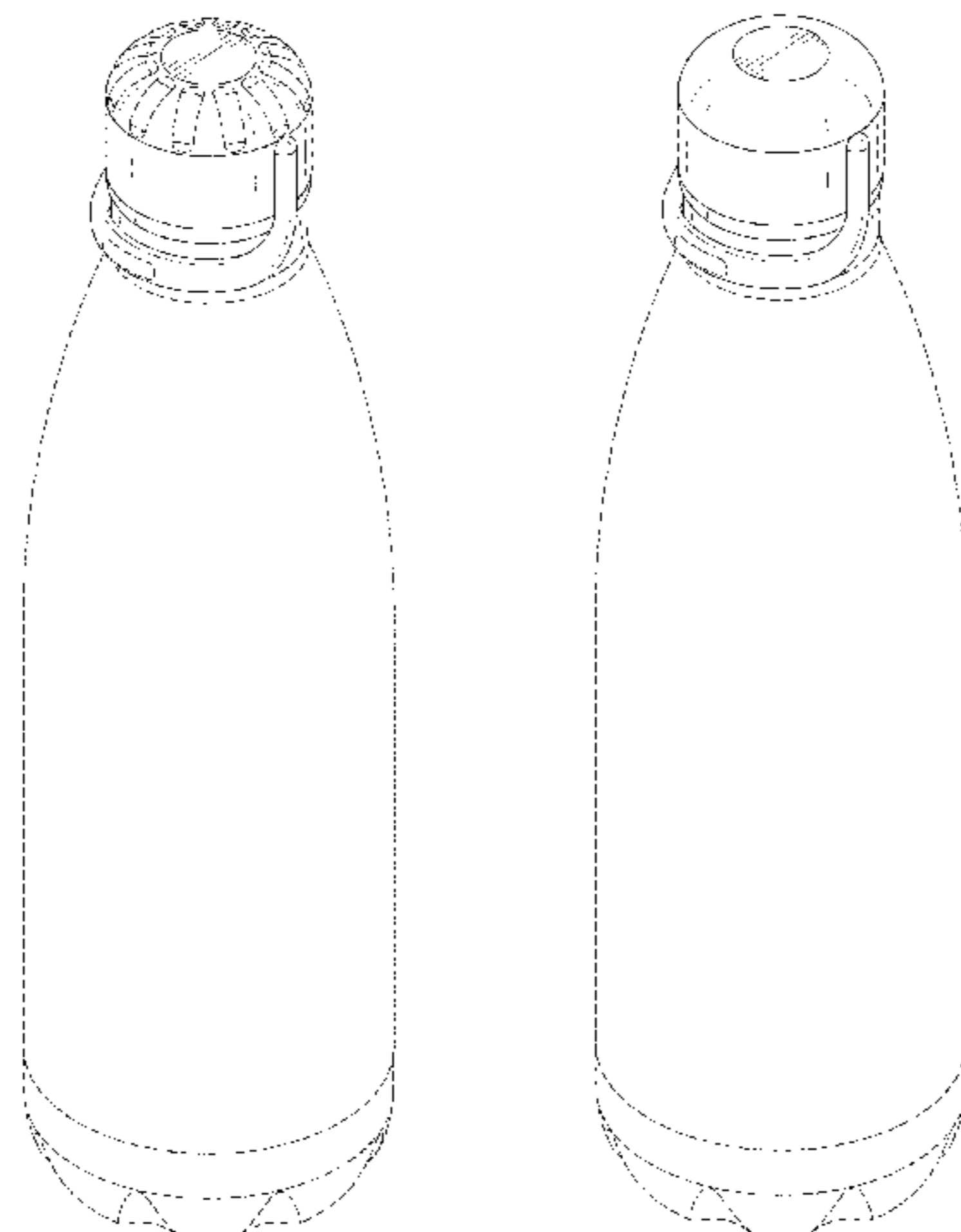

| | | | | |
|--------------|------|---------|-----------------------|-------------|
| 3,462,035 | A | 8/1969 | Grussen | |
| D276,790 | S | 12/1984 | Laske | |
| D280,386 | S | 9/1985 | Dinand | |
| D284,549 | S | 7/1986 | Vaussanvin | |
| D306,970 | S | 4/1990 | Bauer-Secundus et al. | |
| D332,379 | S | 1/1993 | Murphy | |
| D332,912 | S | 2/1993 | Trussardi | |
| D369,525 | S | 5/1996 | Winters | |
| D380,386 | S * | 7/1997 | Dinand | D9/435 |
| D414,685 | S | 10/1999 | Chahed | |
| D415,426 | S | 10/1999 | Herrmann | |
| D495,603 | S | 9/2004 | Walsh et al. | |
| D612,235 | S | 3/2010 | Cresswell et al. | |
| D615,360 | S | 5/2010 | Joy et al. | |
| D620,357 | S * | 7/2010 | Jewett | D9/443 |
| D641,594 | S | 7/2011 | Huang | |
| D672,238 | S | 12/2012 | Aziz et al. | |
| D672,609 | S * | 12/2012 | Aziz | D7/507 |
| D686,886 | S | 7/2013 | Meyers et al. | |
| D686,888 | S | 7/2013 | Meyers et al. | |
| D690,987 | S | 10/2013 | Gallen | |
| D703,997 | S | 5/2014 | Munari | |
| D708,954 | S | 7/2014 | Barnes et al. | |
| 8,833,586 | B2 | 9/2014 | Meyers et al. | |
| D724,385 | S * | 3/2015 | Hurley | D7/511 |
| D743,269 | S | 11/2015 | Pape | |
| D762,418 | S | 8/2016 | Sorensen et al. | |
| D762,476 | S | 8/2016 | Velmer et al. | |
| D763,087 | S | 8/2016 | Hirst | |
| D786,012 | S | 5/2017 | Hein et al. | |
| D787,935 | S | 5/2017 | Kaiser | |
| 9,713,813 | B2 * | 7/2017 | Ballhause | B04B 5/0421 |
| D794,460 | S * | 8/2017 | Notheis | D9/443 |
| D795,013 | S * | 8/2017 | Shultz | D7/392.1 |
| D799,900 | S | 10/2017 | Santos et al. | |
| D802,994 | S * | 11/2017 | Seiders | D7/392.1 |
| D806,468 | S * | 1/2018 | Goodwin | D7/392.1 |
| D808,220 | S * | 1/2018 | Burns | D7/510 |
| D808,226 | S | 1/2018 | Bradley | |
| D809,384 | S | 2/2018 | Best et al. | |
| 2016/0318693 | A1 | 11/2016 | Hein et al. | |
| 2017/0158412 | A1 | 6/2017 | Seiders et al. | |

FOREIGN PATENT DOCUMENTS

| | | |
|----|---------------|---------|
| CN | 303506007 | 12/2015 |
| FR | 2291097 A2 | 6/1976 |
| JP | H11349027 A | 12/1999 |
| KR | 3007733220000 | 11/2014 |
| NO | 20160345-0001 | 4/2016 |

OTHER PUBLICATIONS

Solana Stainless Steel Vacuum Bottle: Site Visited Jan. 31, 2018. Available from Internet URL: <https://www.discountmugs.com/product/lmkw1402-17-oz-solana-304-stainless-steel-vacuum-bottles-with-copper-lining/>.*

Modern Innovations Stainless Steel Water Bottle: Announced May 7, 2016. Site Visited Jan. 31, 2018. Available from Internet URL: <https://www.amazon.com/Modern-Innovations-Stainless-Steel-Bottles/dp/B0764JJ62R>.*

Reuseit Insulated Stainless Steel Water Bottle with Handle: Announced Jan. 7, 2017 [Online]. Site Visited Jan. 31, 2017. Available from Internet URL: <http://www.reuseit.com/reuseit-insulated-stainless-steel-water-bottle-with-handle-17oz.htm>.*

S'well Bottle: Announced May 6, 2013 [online]. Site Visited Jan. 31, 2018. Available from Internet URL: <https://www.youtube.com/watch?v=0fqx3GFGfig>.*

Swell Bottle: Announced Apr. 15, 2017 [online], site visited: Available from Internet URL: <https://web.archive.org/web/20170415223309/https://www.swellbottle.com/bottles>.

Reuseit Stainless Steel Water Bottle: Site Visited Jun. 29, 2017 [online]. Available from Internet URL: <http://www.reuseit.com/reuseit-insulated-stainless-steel-water-bottle-with-handle-17oz.htm>.

Stainless Steel Replacement Lid for Hydro Flask: Site Visited Jun. 29, 2017 [online]. Available from Internet URL: <https://www.pinterest.com/pin/821695894483260180/>.

* cited by examiner

Primary Examiner — Jennifer Rivard

Assistant Examiner — Catherine S Posthauer

(74) Attorney, Agent, or Firm — Kilpatrick Townsend & Stockton LLP

(57) CLAIM

The ornamental design for a combination bottle and cap with L-shaped handle, as shown and described.

DESCRIPTION

FIG. 1 is a perspective view of a first embodiment of a combination bottle and cap with L-shaped handle showing our new design;

FIG. 2 is a front elevational view thereof;

FIG. 3 is a rear elevational view thereof;

FIG. 4 is a right-side elevational view thereof;

FIG. 5 is a left-side elevational view thereof;

FIG. 6 is a top view thereof;

FIG. 7 is a bottom view thereof;

FIG. 8 is a perspective view thereof, showing the handle in an alternate position of use;

FIG. 9 is a front elevational view thereof;

FIG. 10 is a rear elevational view thereof;

FIG. 11 is a right-side elevational view thereof;

FIG. 12 is a left-side elevational view thereof;

FIG. 13 is a top view thereof;

FIG. 14 is a bottom view thereof;

FIG. 15 is a perspective view of a second embodiment of a combination bottle and cap with an L-shape handle;

FIG. 16 is a front elevational view thereof;

FIG. 17 is a rear elevational view thereof;

FIG. 18 is a right-side elevational view thereof;

FIG. 19 is a left-side elevational view thereof;

FIG. 20 is a top view thereof;

FIG. 21 is a bottom view thereof;

FIG. 22 is a perspective view thereof, showing the handle in an alternate position of use;

FIG. 23 is a front elevational view thereof;

FIG. 24 is a rear elevational view thereof;

FIG. 25 is a right-side elevational view thereof;

FIG. 26 is a left-side elevational view thereof;

FIG. 27 is a top view thereof; and,

FIG. 28 is a bottom view thereof.

The broken lines below the bottle neck are shown for the purpose of illustrating parts of the article that form no part of the claim. The broken lines immediately adjacent the shaded surfaces form boundaries of the claim and form no part thereof.

1 Claim, 16 Drawing Sheets

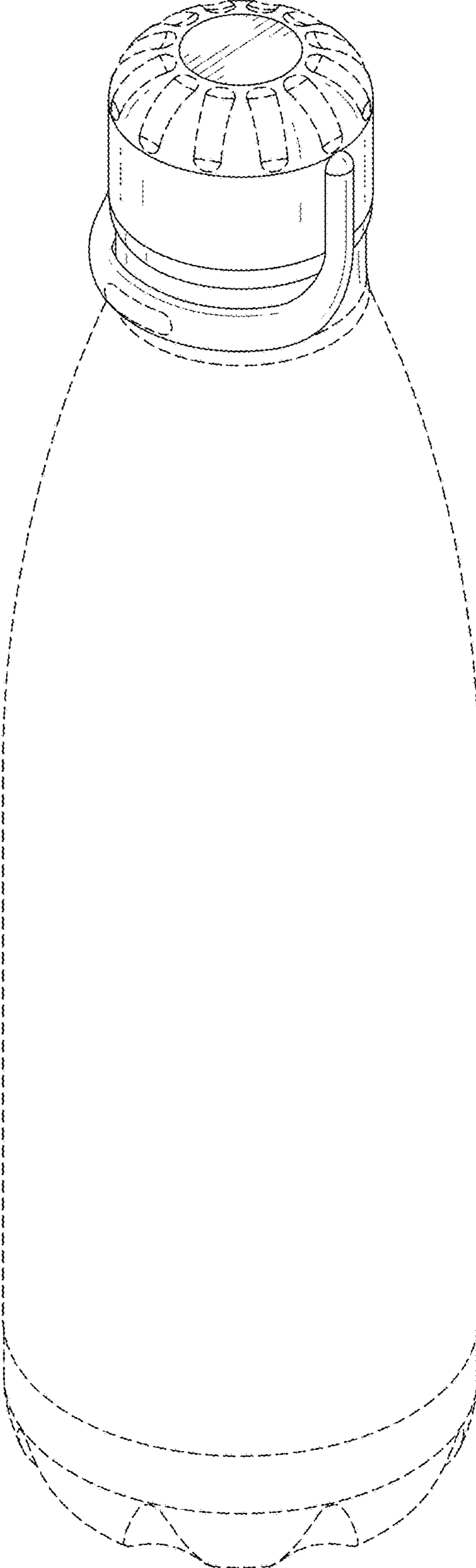

FIG. 1

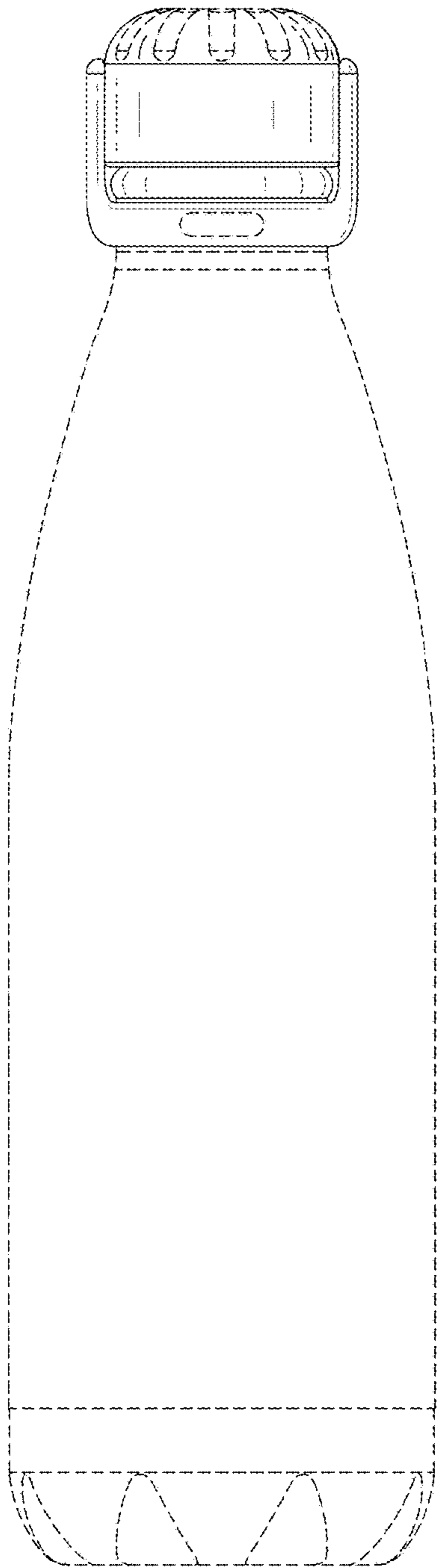

FIG. 2

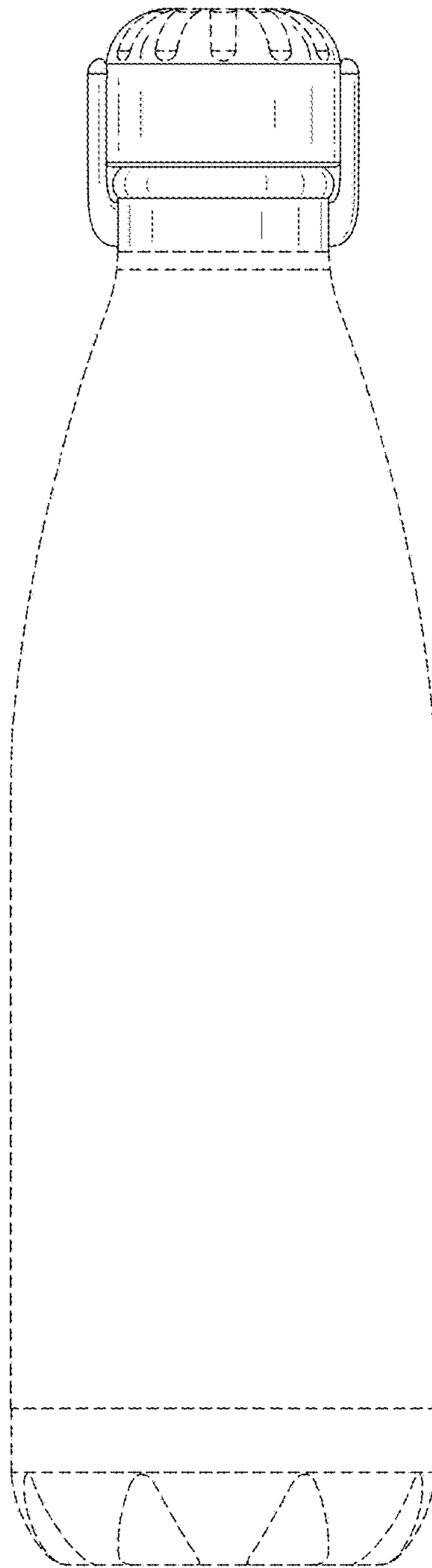

FIG. 3

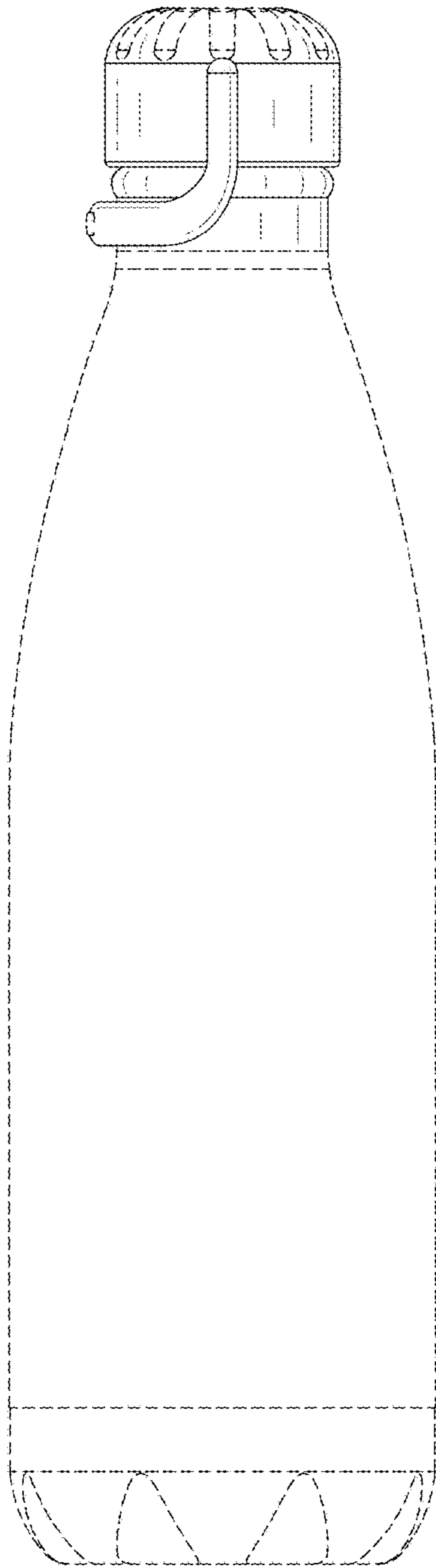

FIG. 4

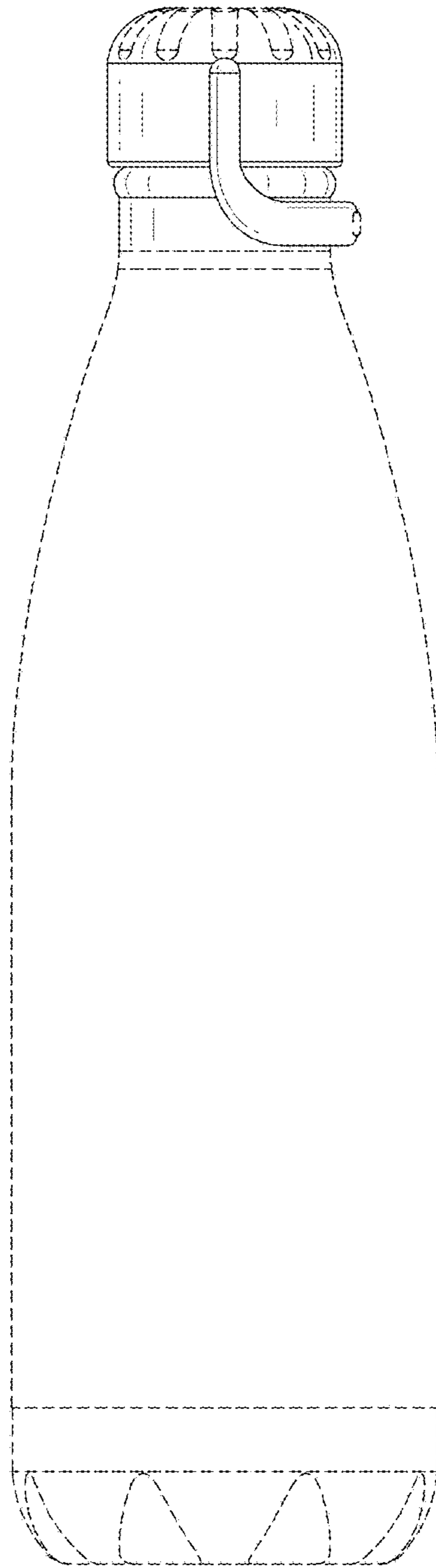

FIG. 5

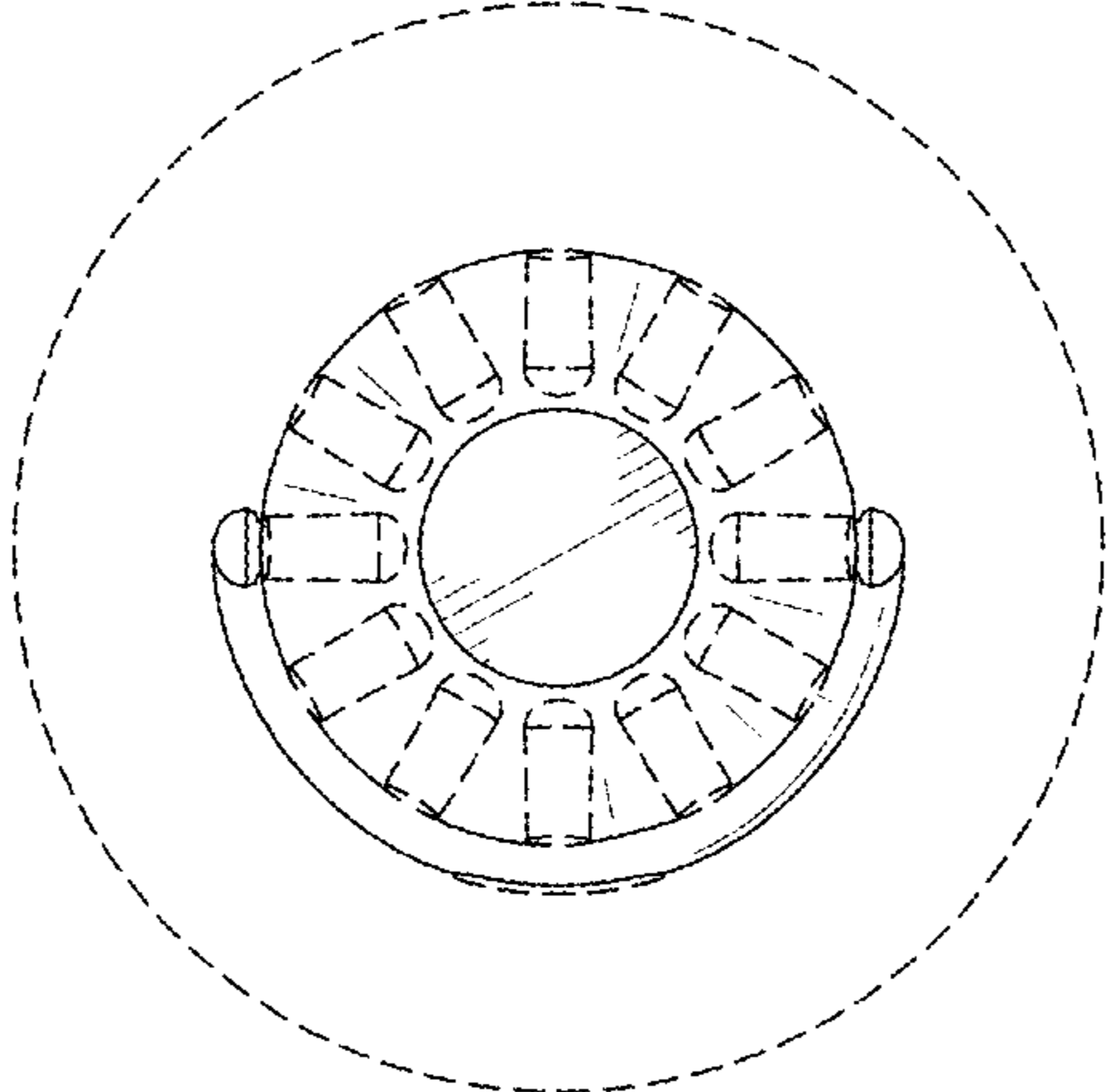

FIG. 6

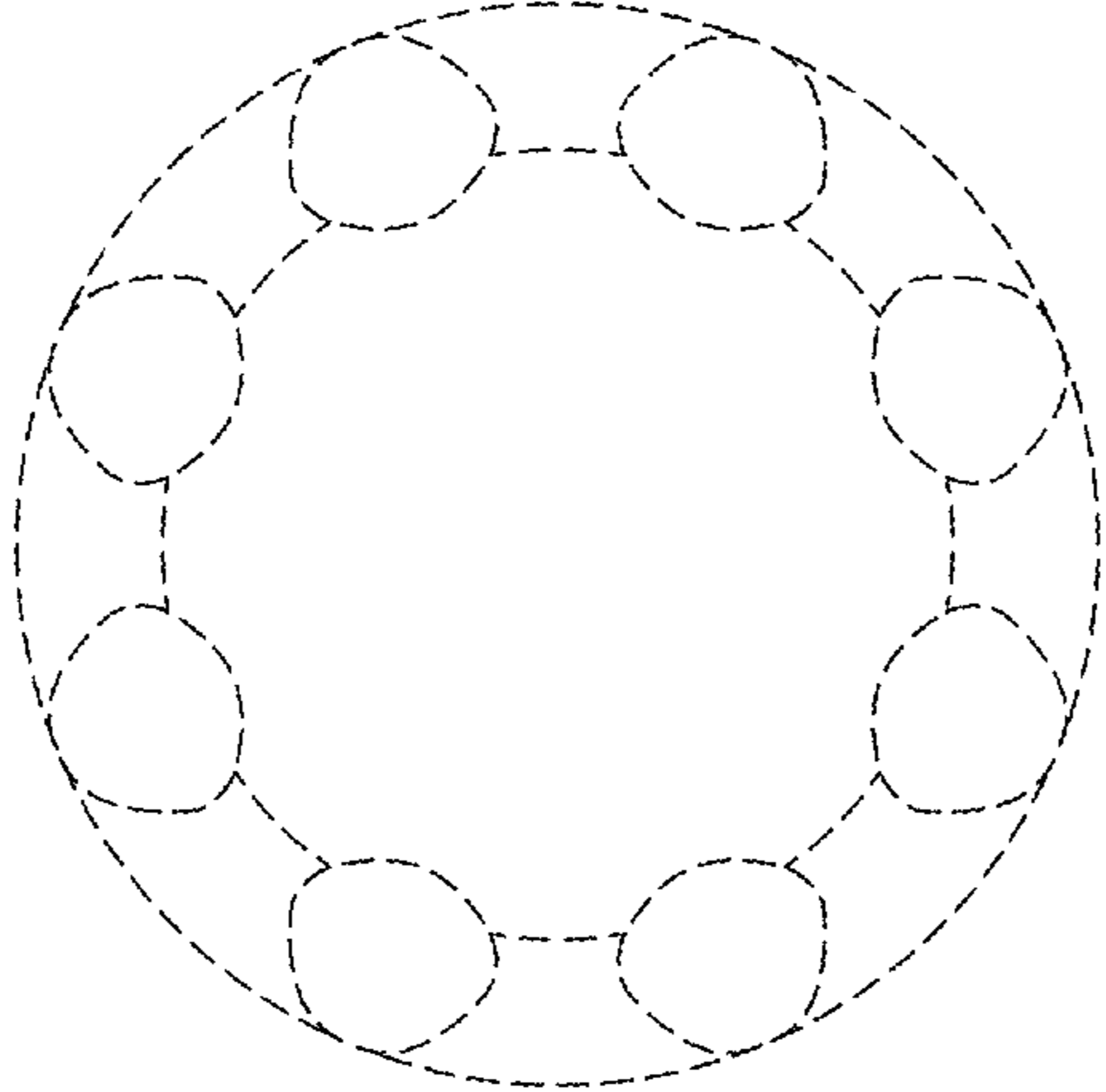

FIG. 7

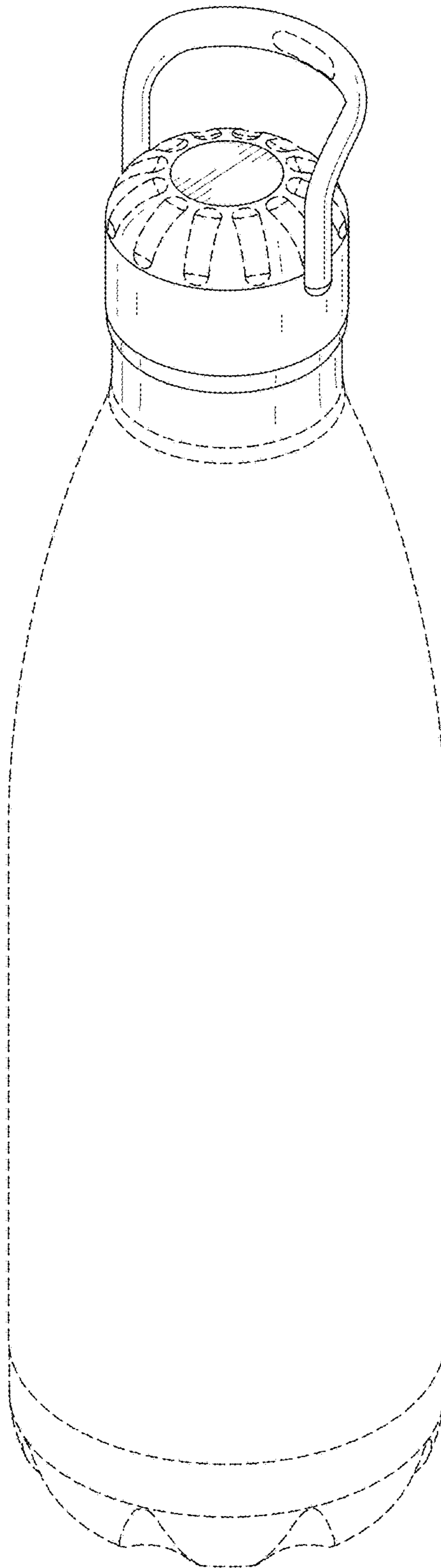

FIG. 8

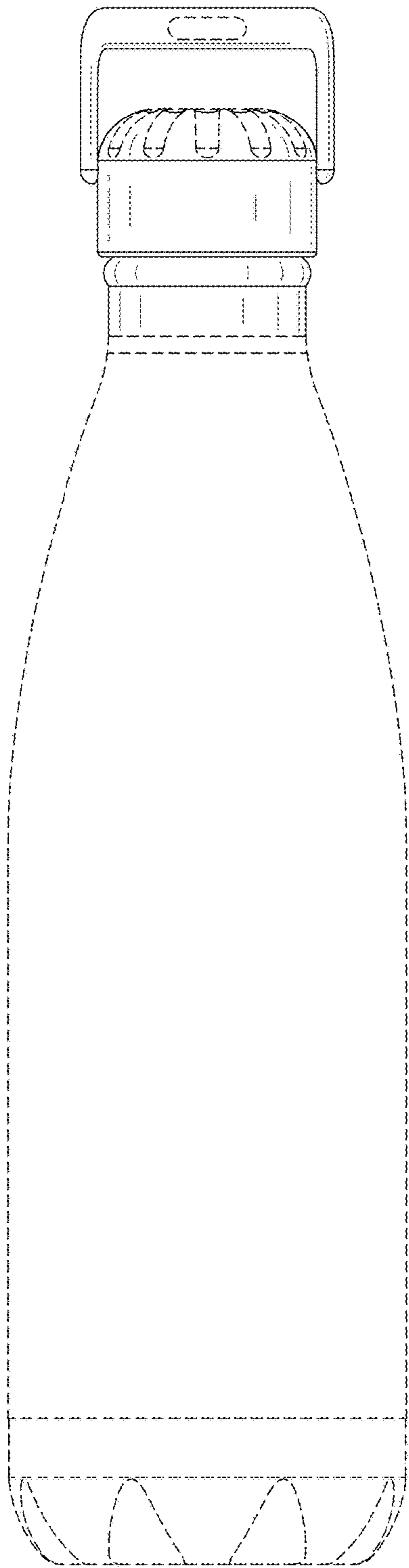

FIG. 9

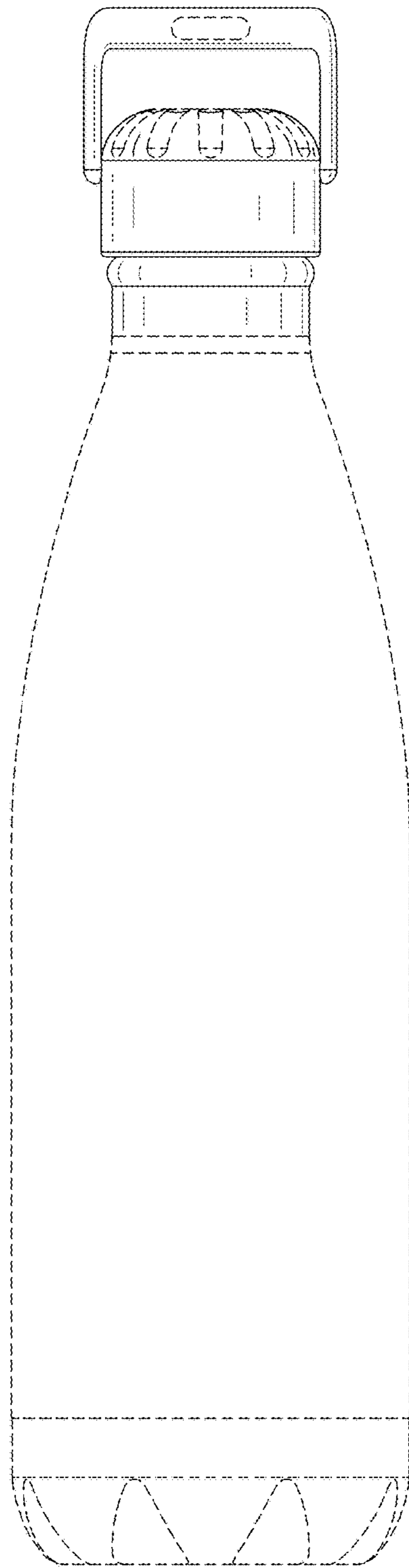

FIG. 10

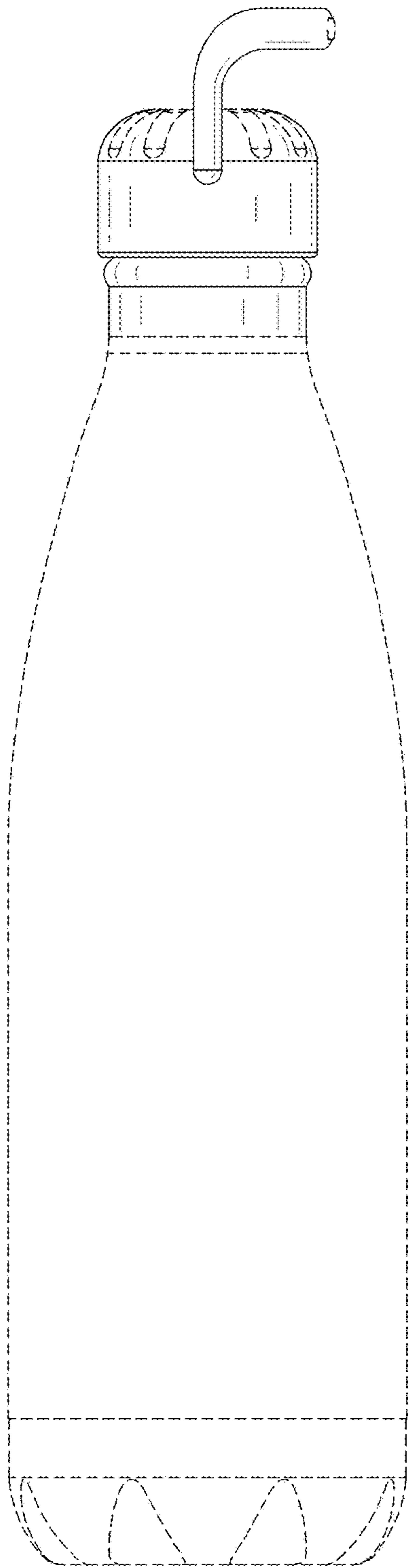

FIG. 11

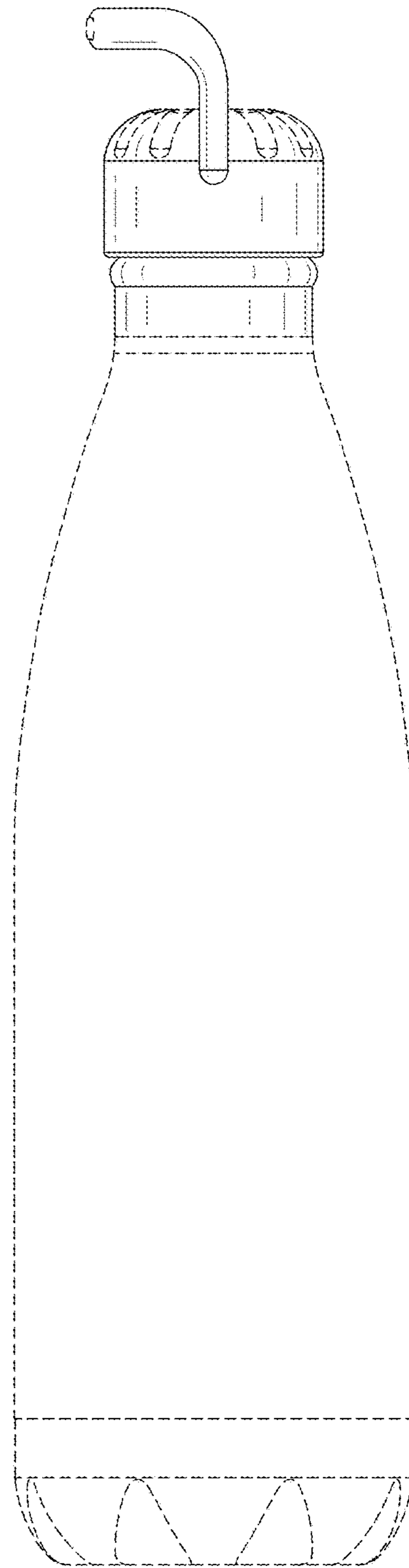

FIG. 12

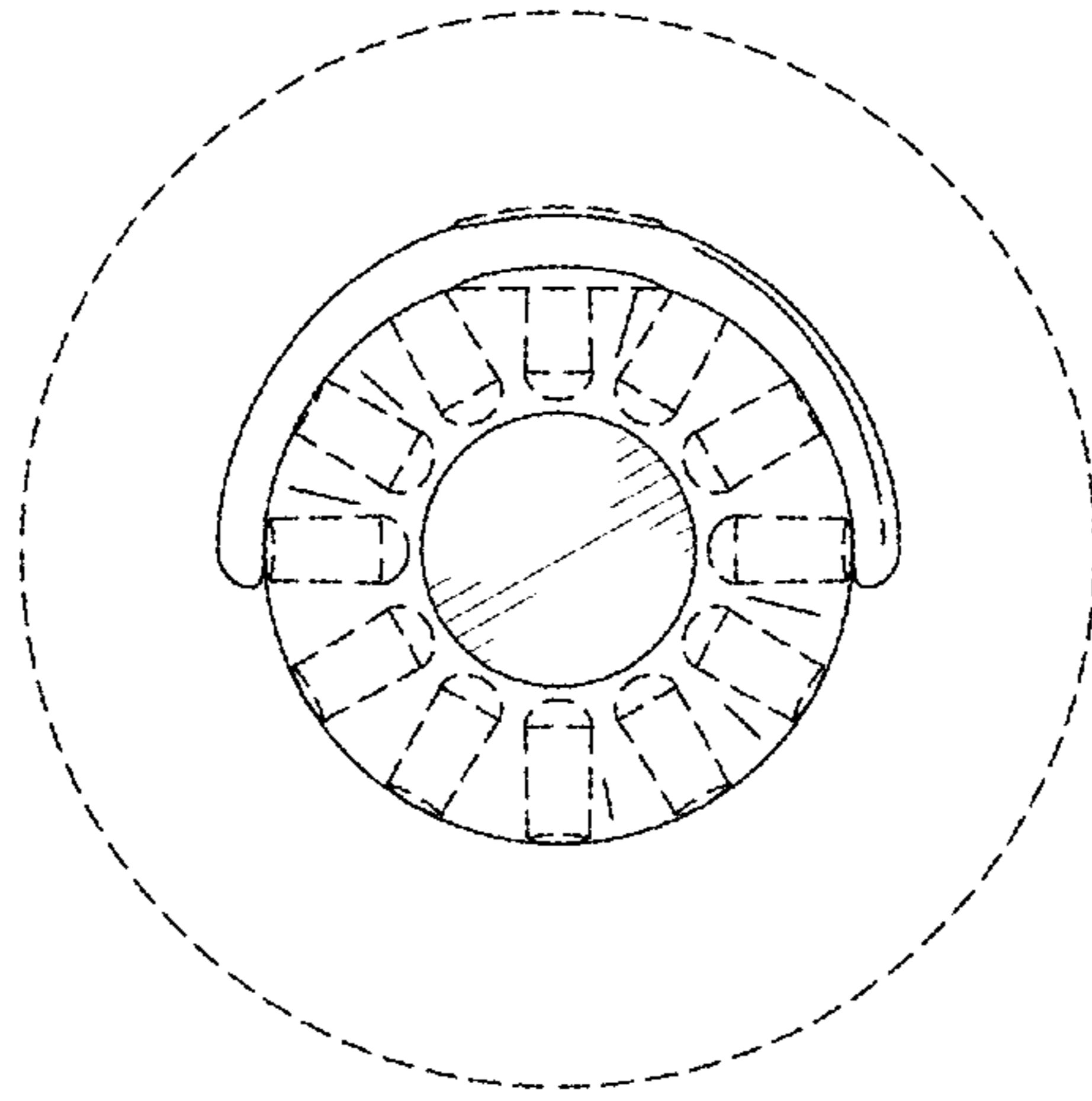

FIG. 13

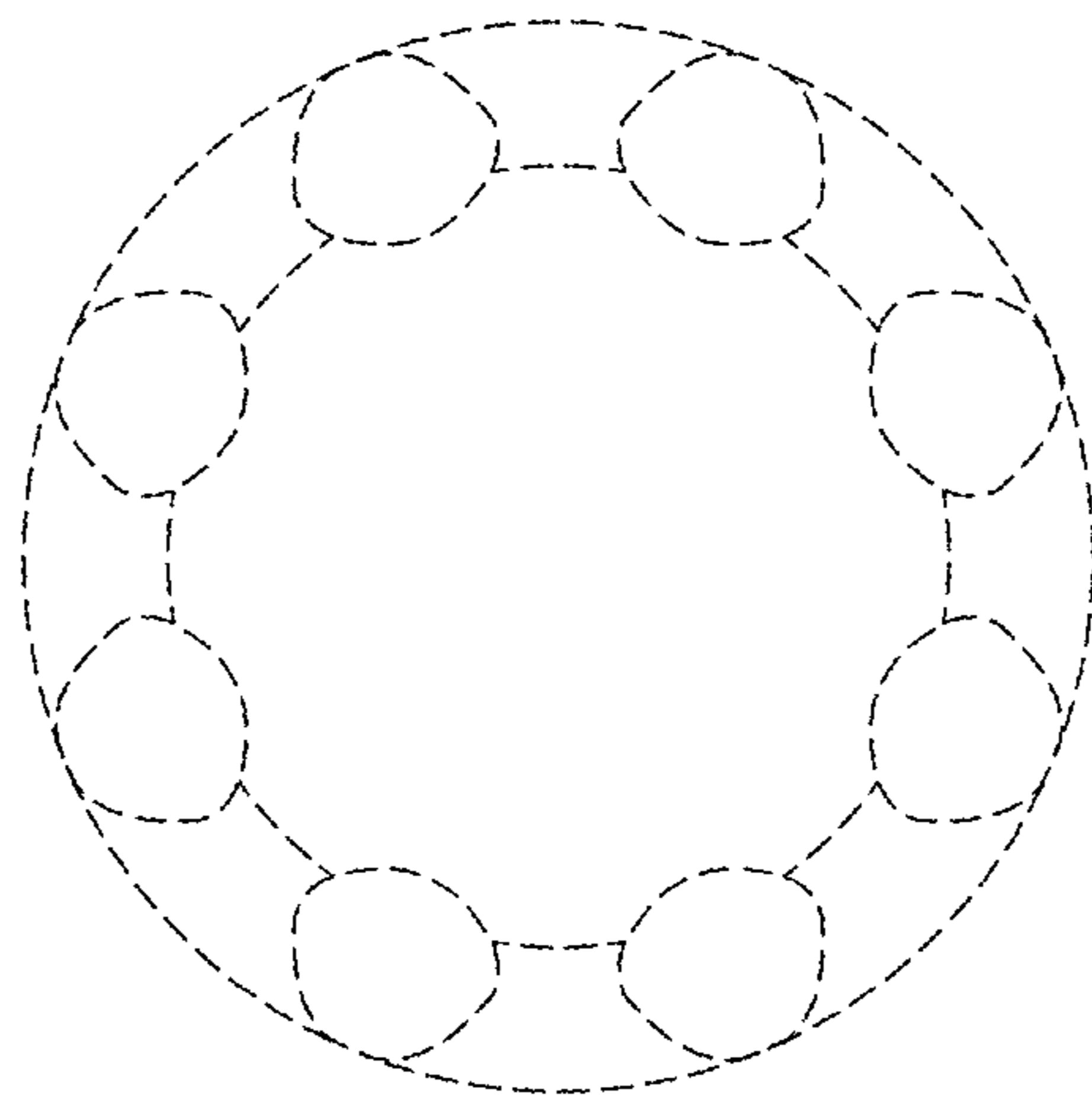

FIG. 14

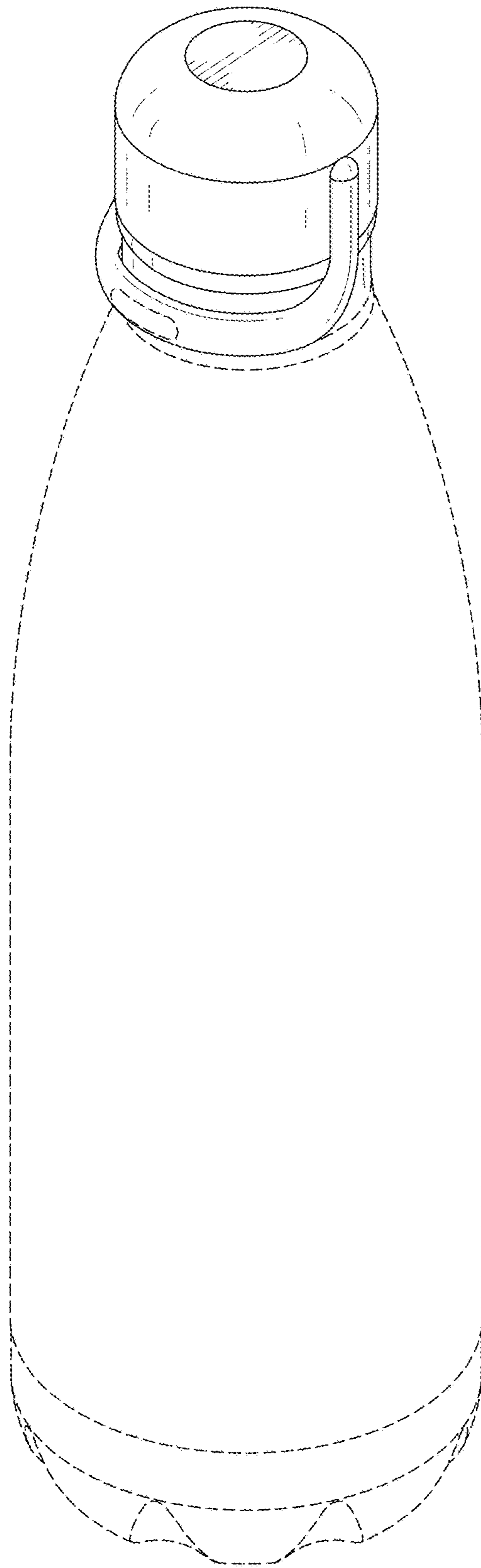

FIG. 15

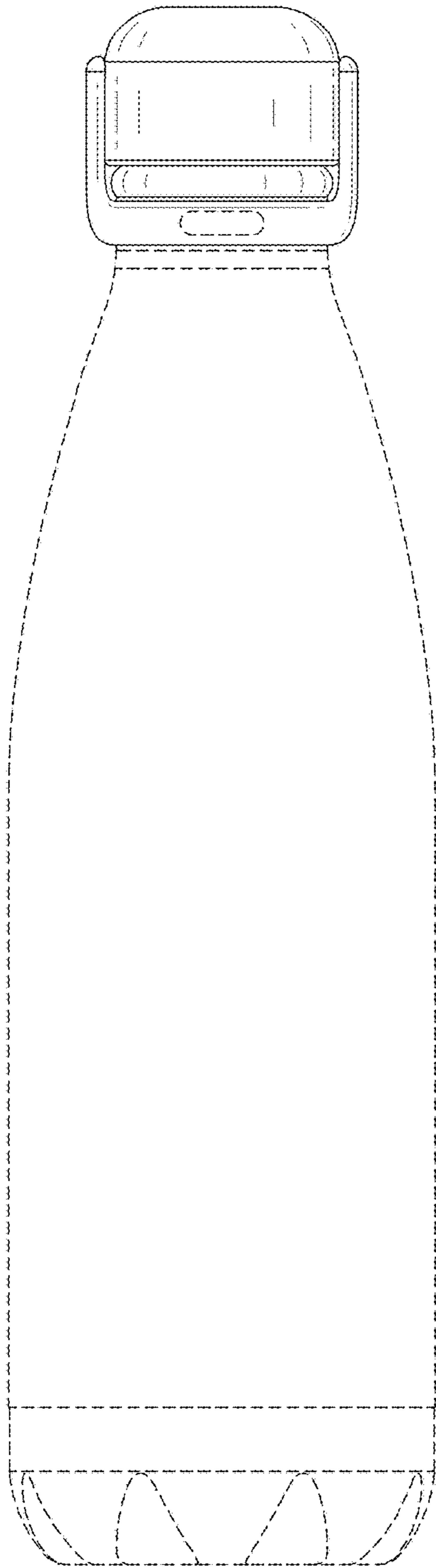

FIG. 16

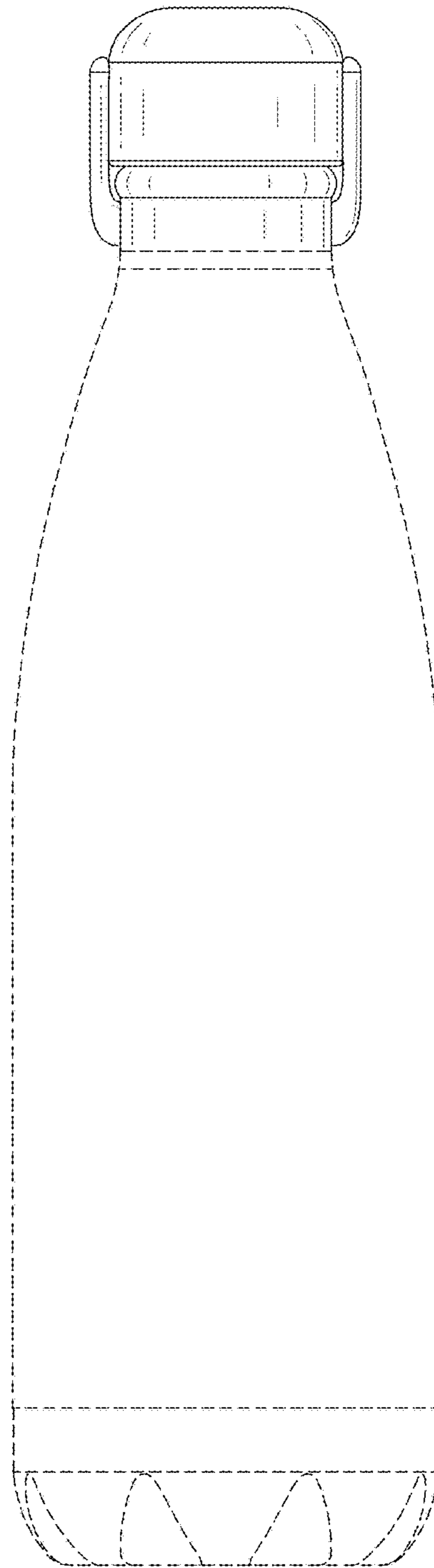

FIG. 17

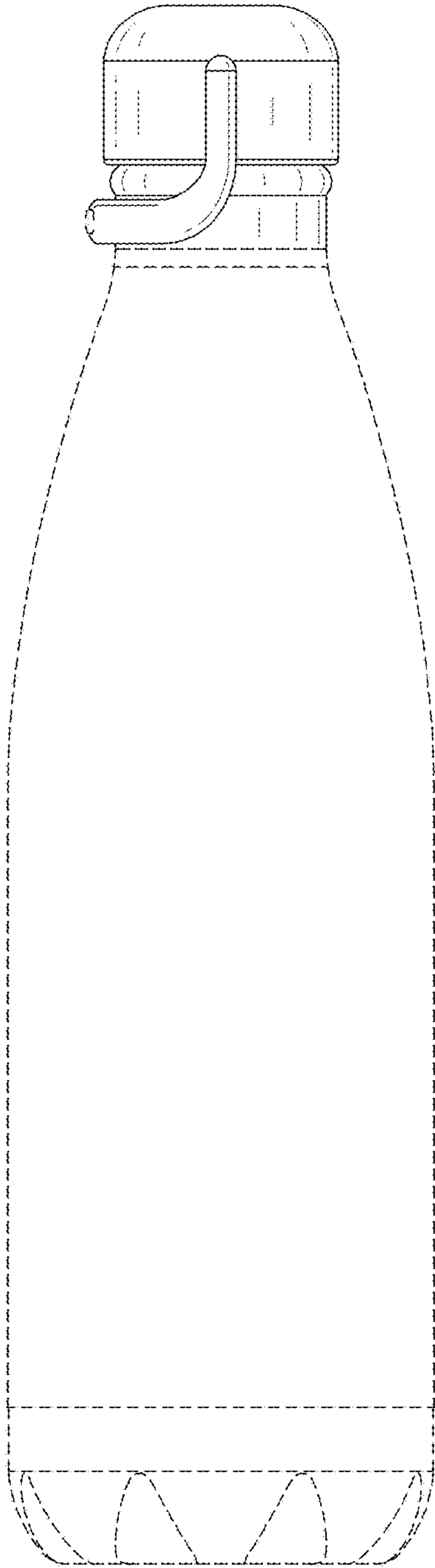

FIG. 18

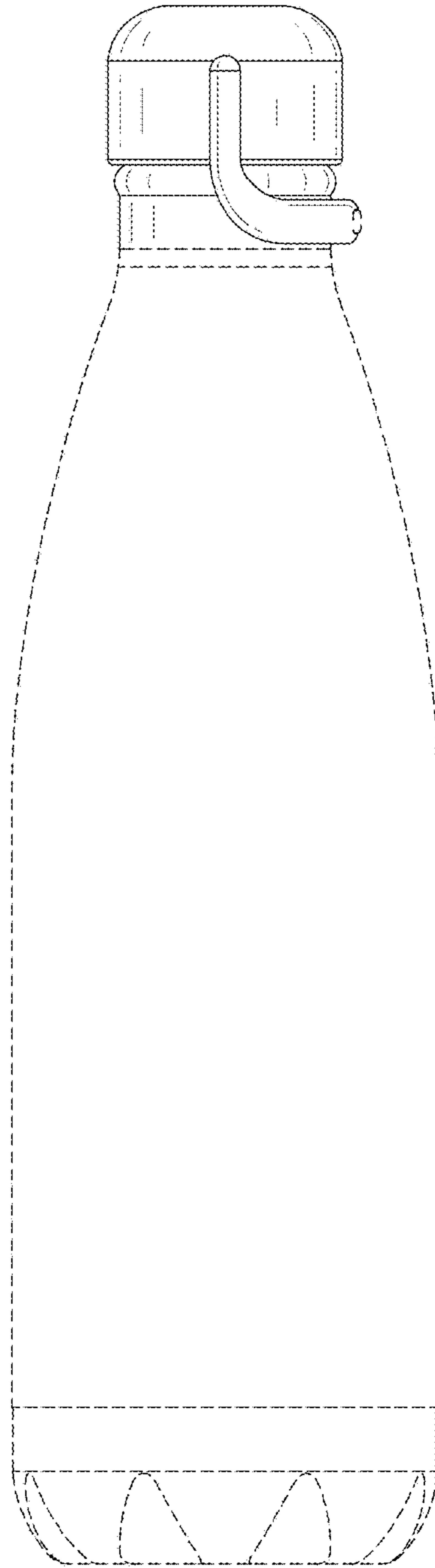

FIG. 19

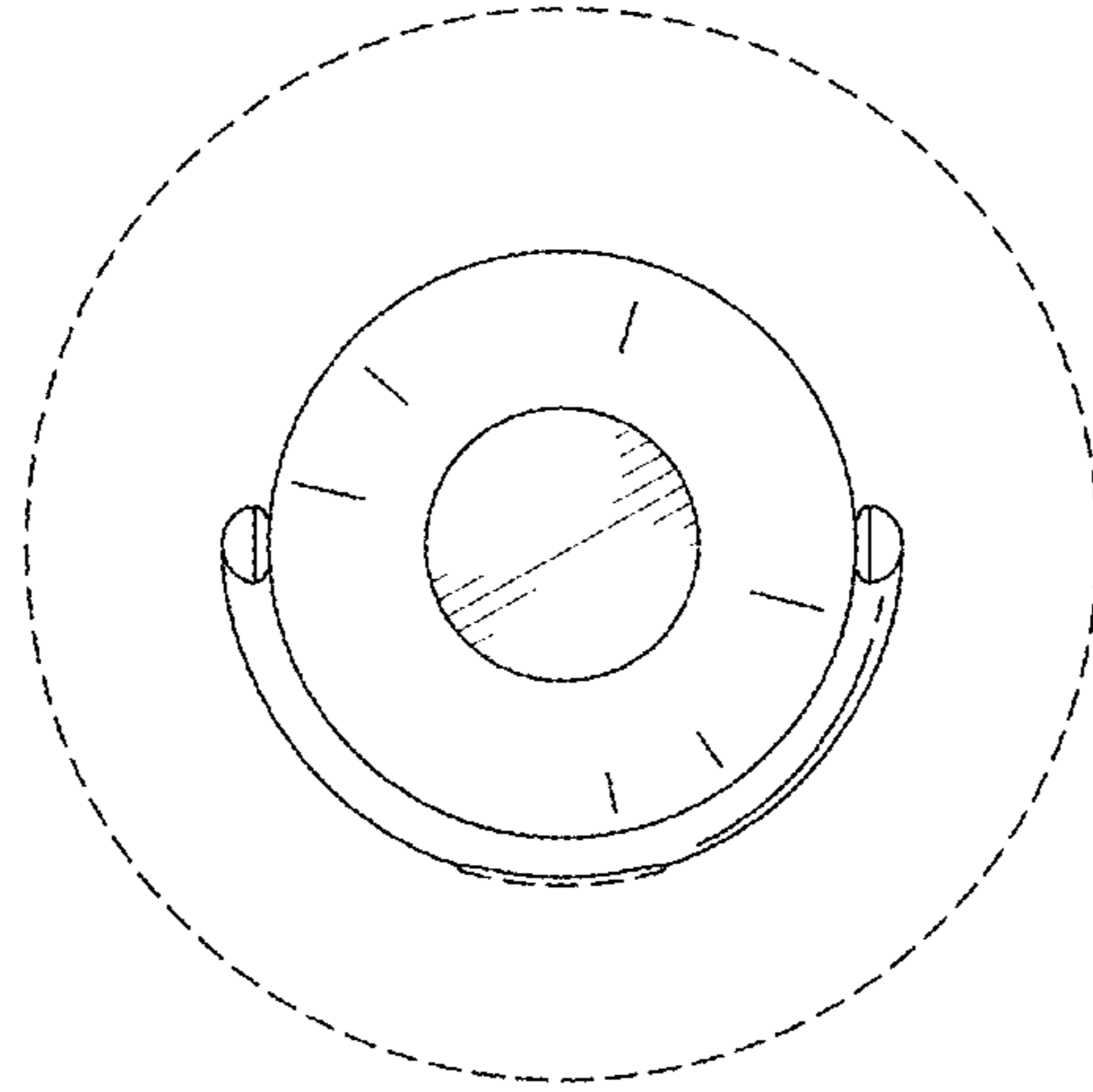

FIG. 20

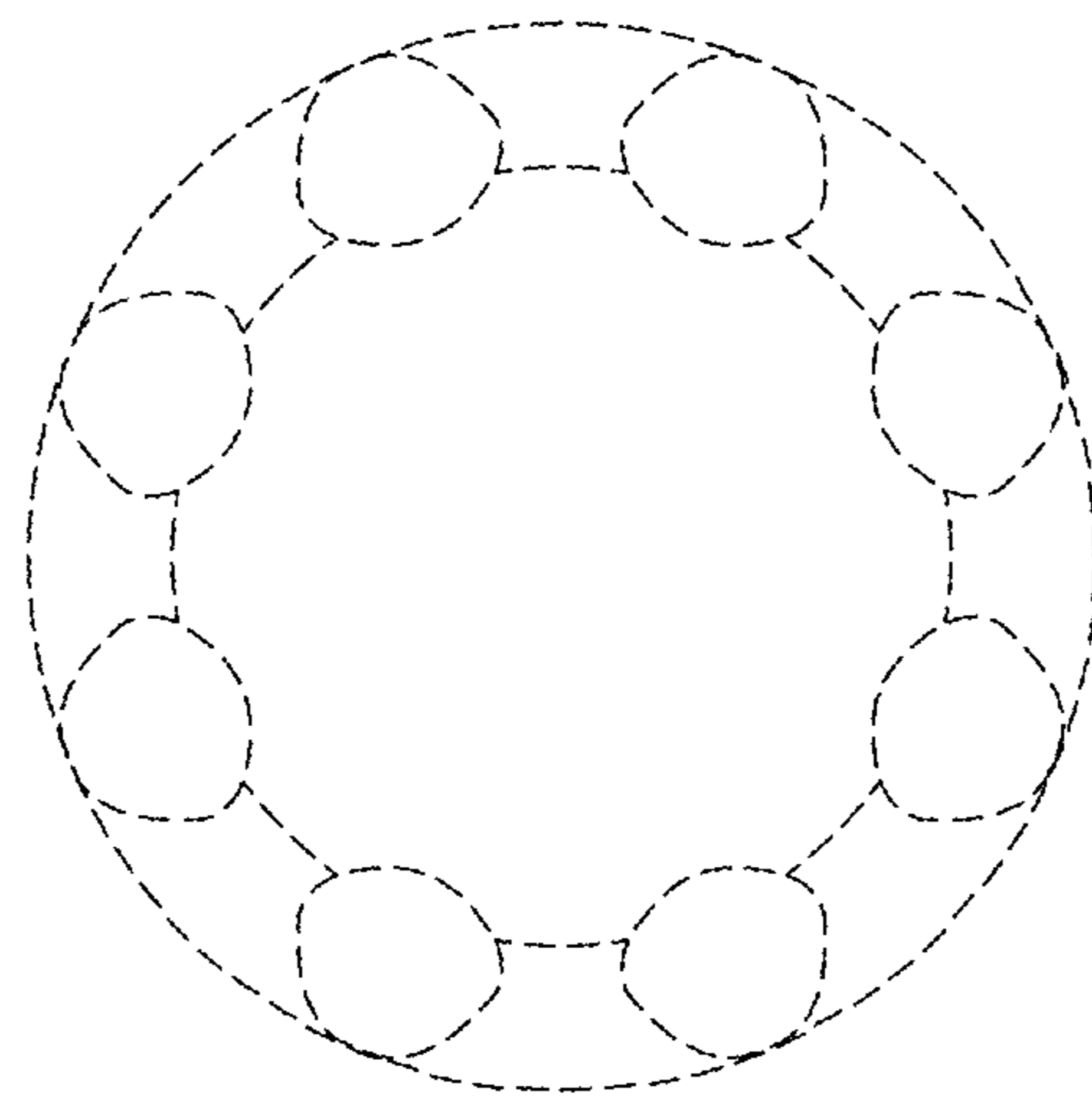

FIG. 21

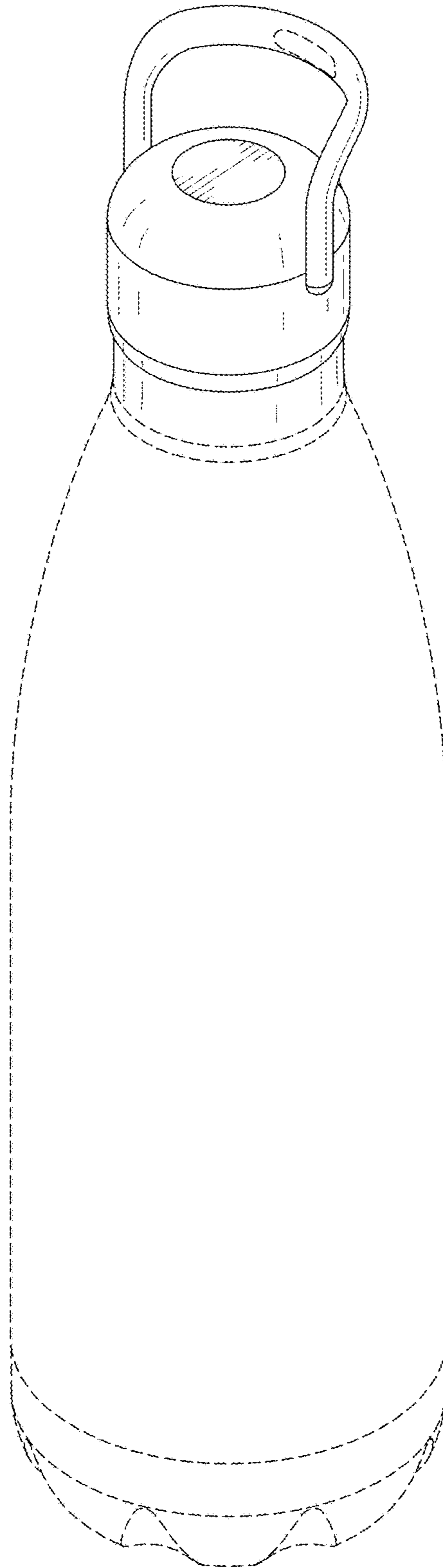

FIG. 22

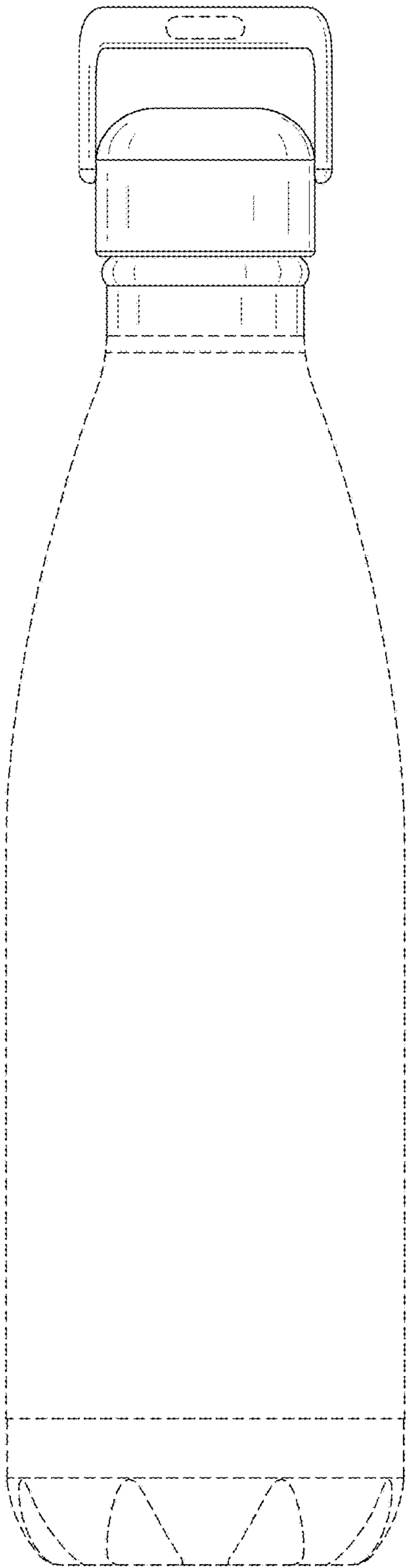

FIG. 23

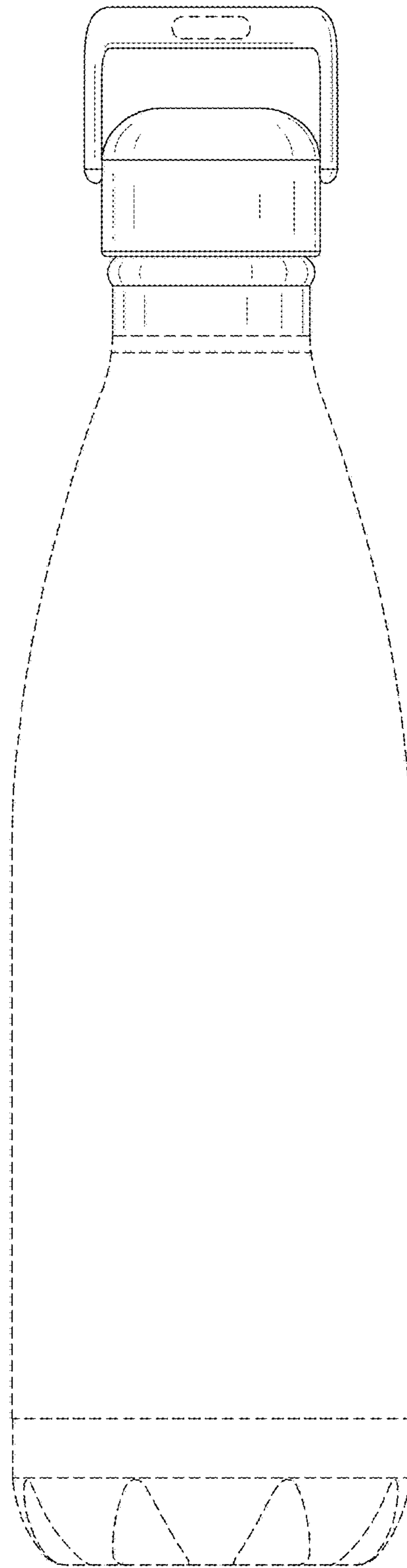

FIG. 24

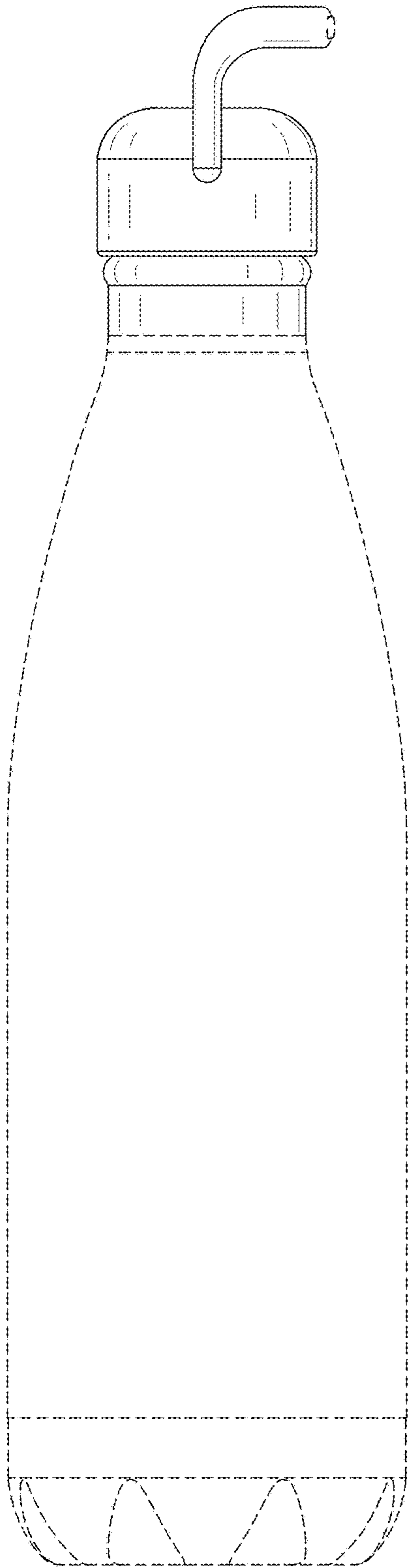

FIG. 25

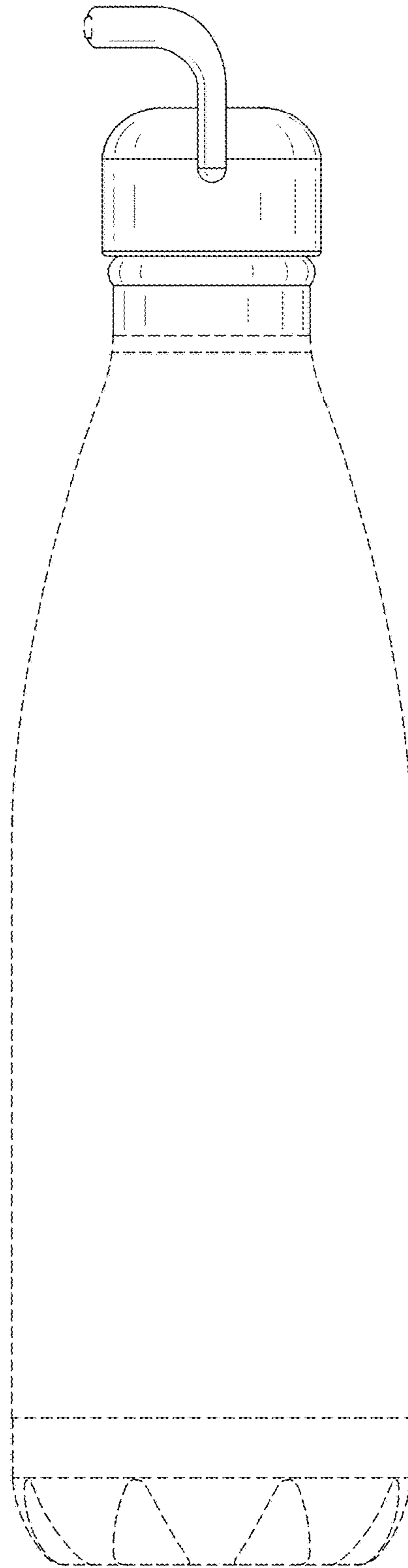

FIG. 26

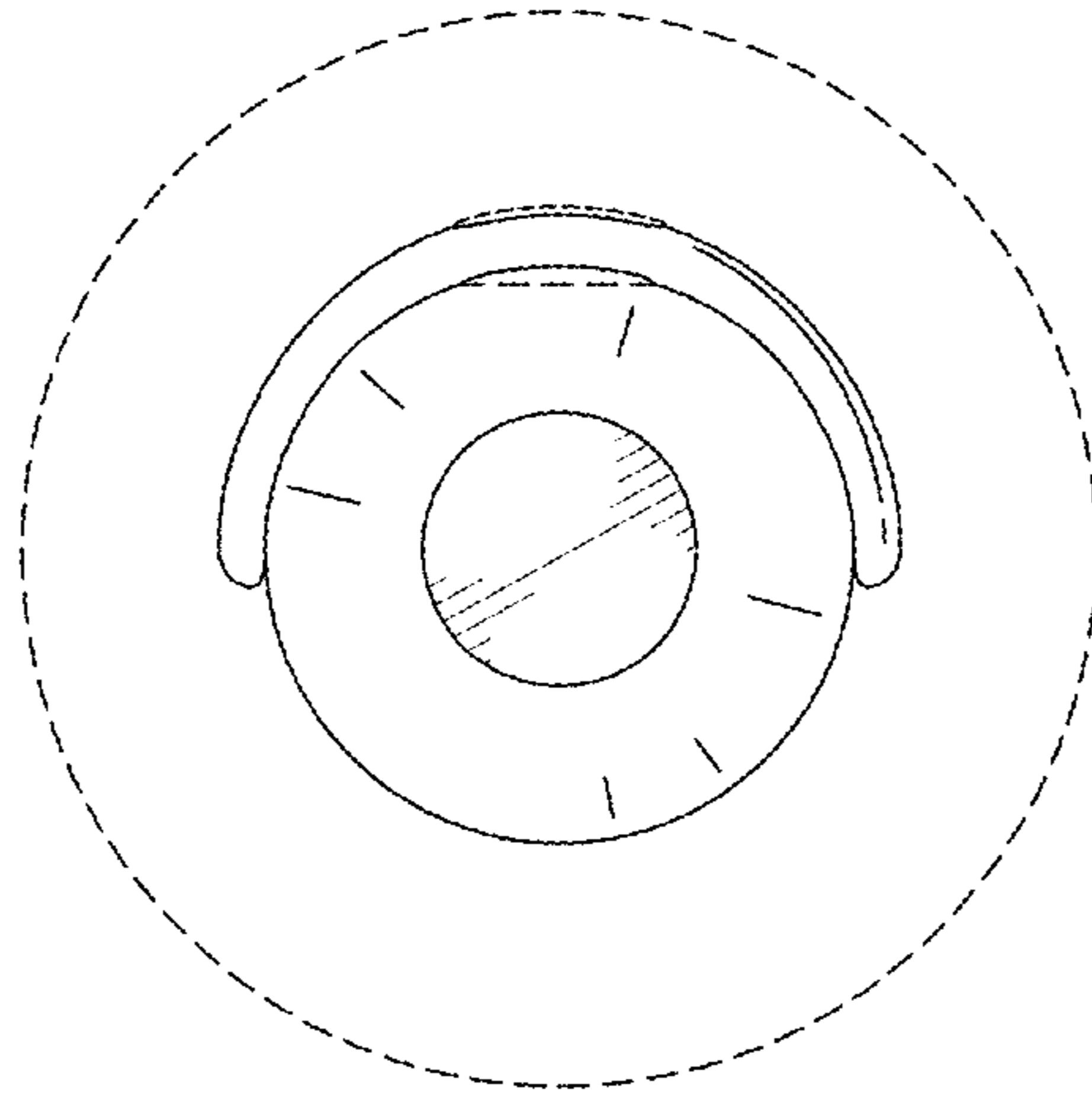

FIG. 27

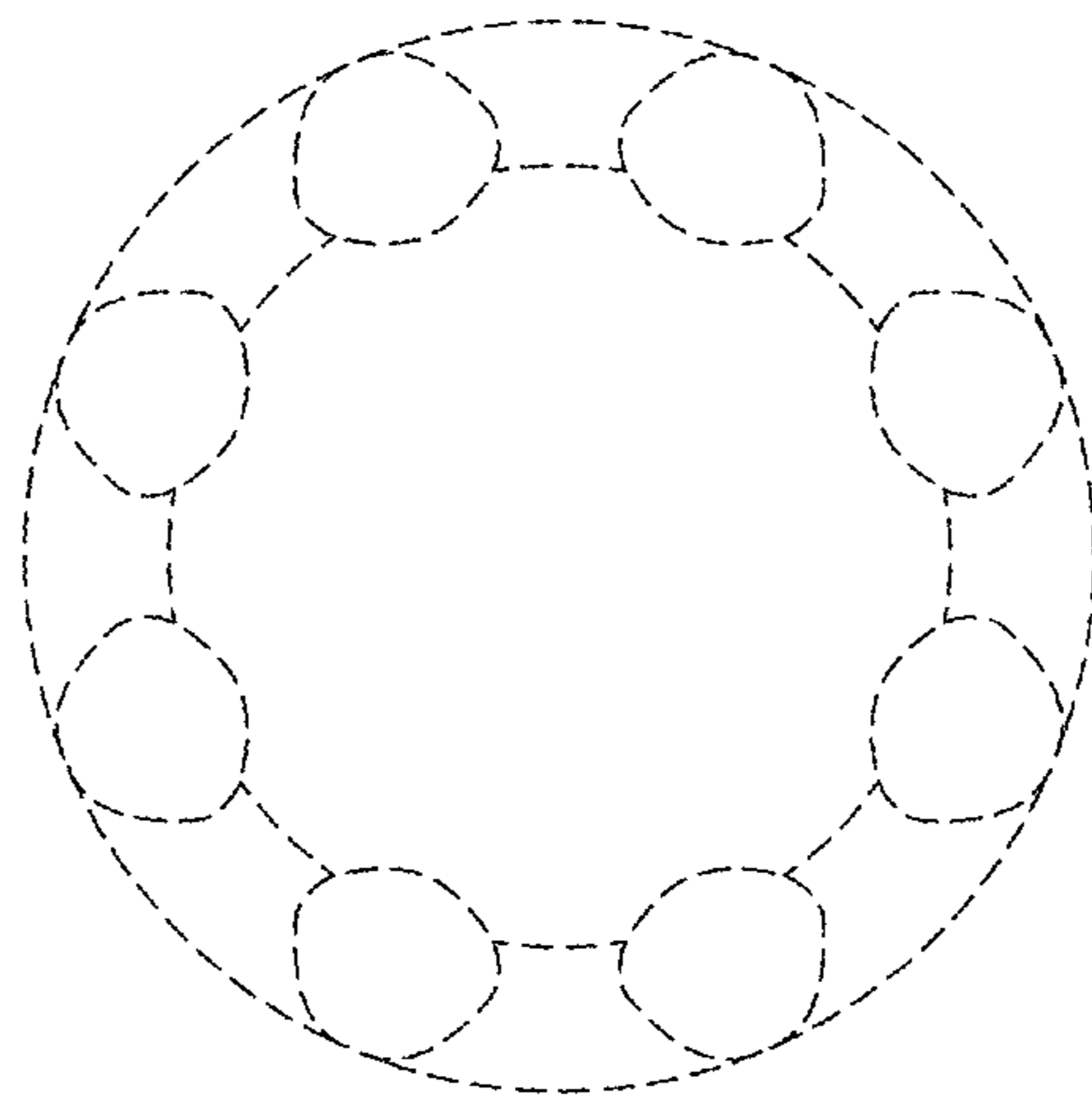

FIG. 28