



US00D831425S

(12) **United States Design Patent** (10) **Patent No.:** **US D831,425 S**
Best et al. (45) **Date of Patent:** **** Oct. 23, 2018**

(54) **COMBINED BOTTLE AND CAP WITH L-SHAPED HANDLE**

(71) Applicant: **Can't Live Without It, LLC**, New York, NY (US)

(72) Inventors: **James Best**, Hewitt, NJ (US); **Clay Allen Burns**, New York, NY (US)

(73) Assignee: **CAN'T LIVE WITHOUT IT, LLC**, New York, NY (US)

(**) Term: **15 Years**

(21) Appl. No.: **29/621,897**

(22) Filed: **Oct. 12, 2017**

Related U.S. Application Data

(62) Division of application No. 29/596,858, filed on Mar. 10, 2017, now Pat. No. Des. 809,384.

(51) **LOC (11) Cl.** **07-01**

(52) **U.S. Cl.**
USPC **D7/510; D9/516**

(58) **Field of Classification Search**
USPC D3/10, 202, 203.1, 203.2, 215, 273, 275, D3/291, 294, 318; D7/300-305, 312,
(Continued)

(56) **References Cited**

U.S. PATENT DOCUMENTS

321,236 A * 6/1885 Morgan B65D 45/24
215/280
358,189 A * 2/1887 Denebeim B65D 55/06
215/278

(Continued)

FOREIGN PATENT DOCUMENTS

CN 303506007 12/2015
FR 2291097 A2 * 6/1976 B65D 23/108

(Continued)

OTHER PUBLICATIONS

Solana Stainless Steel Vacuum Bottle: Site Visited Jan. 31, 2018. Available from Internet URL: <https://www.discountmugs.com/product/lmkw1402-17-oz-solana-304-stainless-steel-vacuum-bottles-with-copper-lining/>.*

(Continued)

Primary Examiner — Jennifer Rivard

Assistant Examiner — Catherine S Posthauer

(74) *Attorney, Agent, or Firm* — Kilpatrick Townsend & Stockton LLP

(57) **CLAIM**

The ornamental design for a combined bottle and cap with L-shaped handle, as shown and described.

DESCRIPTION

FIG. 1 is a perspective view of an embodiment of a combined bottle and cap with L-shaped handle showing our new design;
FIG. 2 is a front elevational view thereof;
FIG. 3 is a rear elevational view thereof;
FIG. 4 is a right-side elevational view thereof;
FIG. 5 is a left-side elevational view thereof;
FIG. 6 is a top view thereof;
FIG. 7 is a bottom view thereof;
FIG. 8 is a perspective view thereof, showing the handle in an alternate position of use;
FIG. 9 is a front elevational view thereof;
FIG. 10 is a rear elevational view thereof;
FIG. 11 is a right-side elevational view thereof;
FIG. 12 is a left-side elevational view thereof;
FIG. 13 is a top view thereof; and,
FIG. 14 is a bottom view thereof.

1 Claim, 8 Drawing Sheets

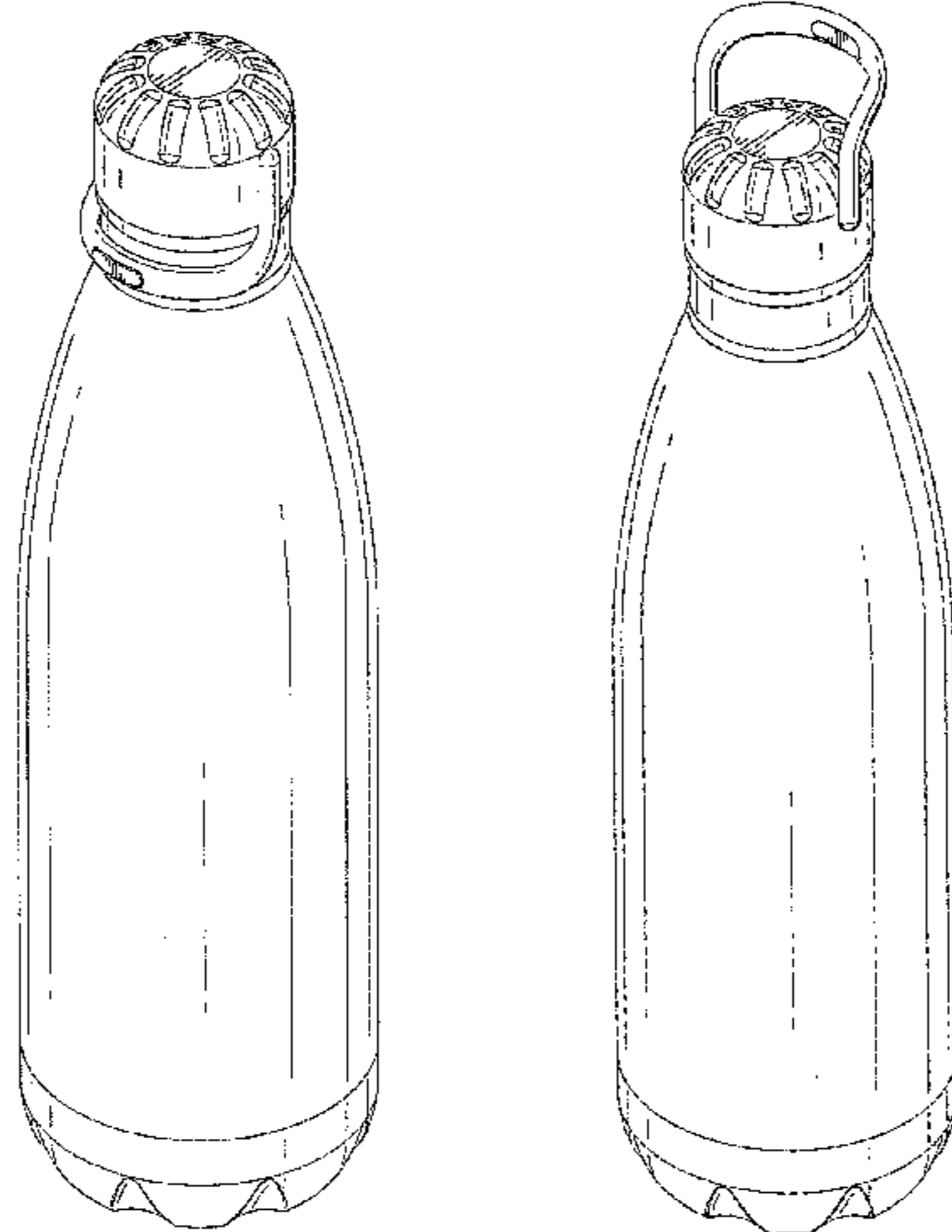

(58) **Field of Classification Search**

USPC .. D7/317, 321, 322, 392.1, 396.2, 500, 505, D7/507, 509, 510, 511, 513, 523, 533, D7/536, 538, 586, 601, 602, 608, 619.1, D7/629, 313, 314, 387, 388, 391, 392, D7/393, 394, 395, 396.1, 397, 398, 403, D7/514, 624.1, 900; D8/300, 302, 303, D8/306, 307, 308, 310, 315, 333, 349, D8/350, 352, 354, 356, 382, 383, 394, D8/395; D9/418, 434-440, 443-450, D9/500, 502, 503, 505, 516, 520, D9/523-527, 528, 529, 530, 531, 534, D9/536, 537, 538, 544, 545, 546, 549, D9/550, 563, 682, 686, 688, 715, 719, D9/738, 451, 453, 455, 452, 454, 774; D19/70, 71, 115, 162, 163, 165, 192, D19/194; D24/121, 127, 197, 224, 108, D24/112, 120, 129, 162, 194, 216; D23/206, 255, 259, 260

CPC B65D 39/00; B65D 39/16; B65D 42/00; B65D 42/02; B65D 43/32; B65D 45/04; B65D 50/00; B65D 50/02; B65D 51/005; B65D 51/007; B65D 51/14; B65D 51/145; B65D 51/18; B65D 51/28; B65D 51/2807; B65D 53/02; B65D 47/06; B65D 47/061; B65D 47/065; B65D 47/08; B65D 47/122; B65D 47/305; B65D 2543/00046; B65D 2543/00027; B65D 2543/00053; B65D 2543/00009; B65D 2539/00; B65D 41/00; B65D 41/02; B65D 41/0225; B65D 41/0233; B65D 41/06; B65D 41/12; B65D 23/108; B65D 23/001; B65D 35/46; B65D 81/3283; B65D 25/24; B65D 2251/0021; B65D 2251/0025; B65D 2251/0028; B65D 2251/0081; B65D 2251/0087; B65D 2251/009; B65D 2543/00231; A47G 19/00; A47G 19/22; A47G 19/2205; A47G 19/2272; A47G 21/18; A47J 43/1087; A47J 43/27

See application file for complete search history.

(56) **References Cited**

U.S. PATENT DOCUMENTS

1,338,494	A	4/1920	Daniel	
1,421,118	A	6/1922	Anderson	
1,669,216	A	5/1928	Stanley	
1,723,260	A	8/1929	Thomssen	
2,169,448	A	8/1939	Linch	
D149,834	S	6/1948	Perkins	
3,000,527	A	9/1961	Jennings et al.	
3,311,252	A	3/1967	Swartwood et al.	
3,412,887	A *	11/1968	Swartwood	B65D 23/108 215/397
3,462,035	A	8/1969	Grussen	
D276,790	S	12/1984	Laske	
D280,386	S	9/1985	Dinand	
D284,549	S	7/1986	Vaissanvin	
D306,970	S	4/1990	Bauer-Secundus et al.	

D332,379	S *	1/1993	Murphy	D7/391
D332,912	S	2/1993	Trussardi	
D369,525	S *	5/1996	Winters	D7/608
D380,386	S *	7/1997	Dinand	D9/435
D414,685	S	10/1999	Chahed	
D415,426	S	10/1999	Herrmann	
D495,603	S	9/2004	Walsh et al.	
D612,235	S *	3/2010	Cresswell	D9/443
D615,360	S *	5/2010	Joy	D7/510
D620,357	S *	7/2010	Jewett	D9/443
D641,594	S	7/2011	Huang	
D672,238	S *	12/2012	Aziz	D7/510
D672,609	S *	12/2012	Aziz	D7/507
D686,886	S	7/2013	Meyers et al.	
D686,888	S	7/2013	Meyers et al.	
D690,987	S *	10/2013	Gallen	D7/392.1
D703,997	S *	5/2014	Munari	D7/393
D708,954	S *	7/2014	Barnes	D7/511
8,833,586	B2	9/2014	Meyers et al.	
D724,385	S *	3/2015	Hurley	D7/511
D743,269	S	11/2015	Pape	
D762,418	S *	8/2016	Sorensen	D7/511
D762,476	S *	8/2016	Velmer	D9/445
D763,087	S *	8/2016	Hirst	D9/500
D786,012	S	5/2017	Hein et al.	
D787,935	S	5/2017	Kaiser	
9,713,813	B2 *	7/2017	Ballhause	B04B 5/0421
D795,013	S *	8/2017	Shultz	D7/392.1
D799,900	S *	10/2017	Santos	D7/510
D806,468	S *	1/2018	Goodwin	D7/392.1
D808,220	S *	1/2018	Burns	D7/510
D808,226	S *	1/2018	Bradley	D7/608
2016/0318693	A1 *	11/2016	Hein	B65D 41/0442
2017/0158412	A1	6/2017	Seiders et al.	

FOREIGN PATENT DOCUMENTS

JP	11349027	A *	12/1999	B65D 51/242
KR	3007733220000		11/2014		
NO	20160345-0001		4/2016		

OTHER PUBLICATIONS

Modern Innovations Stainless Steel Water Bottle: Announced May 7, 2016. Site Visited Jan. 31, 2018. Available from Internet URL: <https://www.amazon.com/Modern-Innovations-Stainless-Steel-Bottles/dp/B0764JJ62R>.*

Reuseit Insulated Stainless Steel Water Bottle with Handle: Announced Jan. 7, 2017 [Online]. Site Visited Jan. 31, 2017. Available from Internet URL: <http://www.reuseit.com/reuseit-insulated-stainless-steel-water-bottle-with-handle-17oz.htm>.*

S'well Bottle: Announced May 6, 2013 [online]. Site Visited Jan. 31, 2018. Available from Internet URL: <https://www.youtube.com/watch?v=0fgx3GFGfig>.*

Swell Bottle: Announced Apr. 15, 2017 [online], site visited: Available from Internet URL: <https://web.archive.org/web/20170415223309/https://www.swellbottle.com/bottles>.

Reusit Stainless Steel Water Bottle: Site Visited Jun. 29, 2017 [online]. Available from Internet URL: <http://www.reuseit.com/reuseit-insulated-stainless-steel-water-bottle-with-handle-17oz.htm>.

Stainless Steel Replacement Lid for Hydro Flask: Site Visited Jun. 29, 2017 [online]. Available from Internet URL: <https://www.pinterest.com/pin/821695894483260180/>.

* cited by examiner

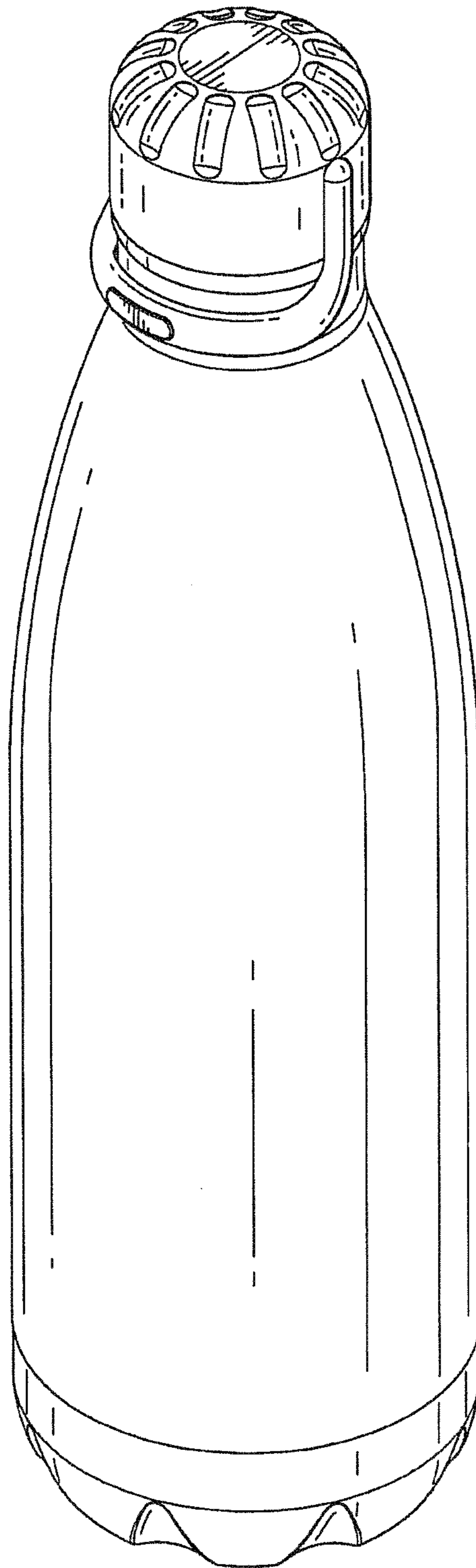

FIG. 1

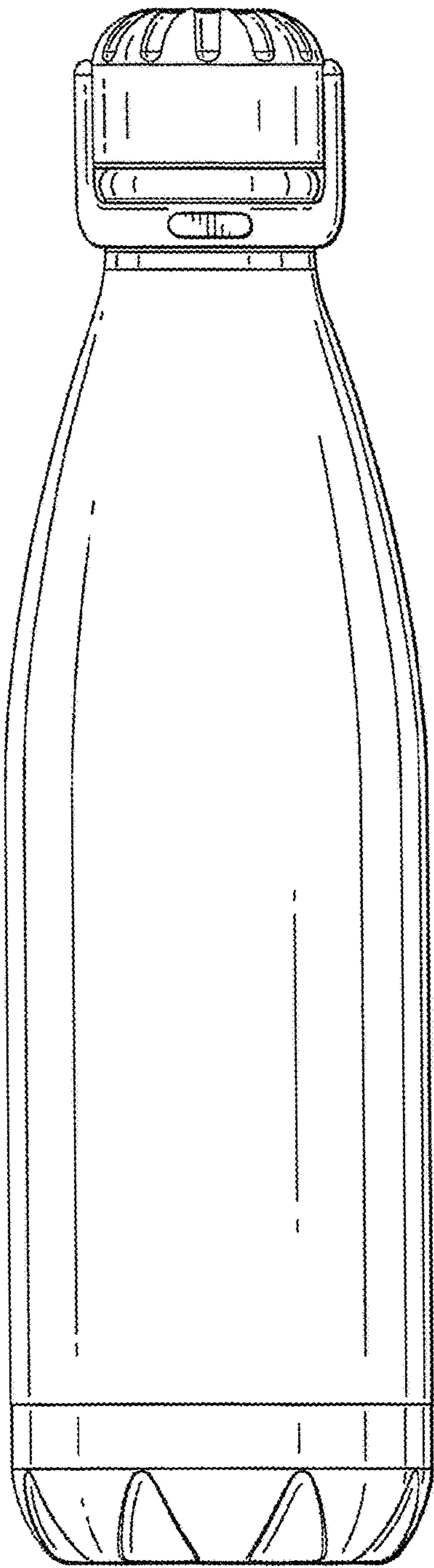

FIG. 2

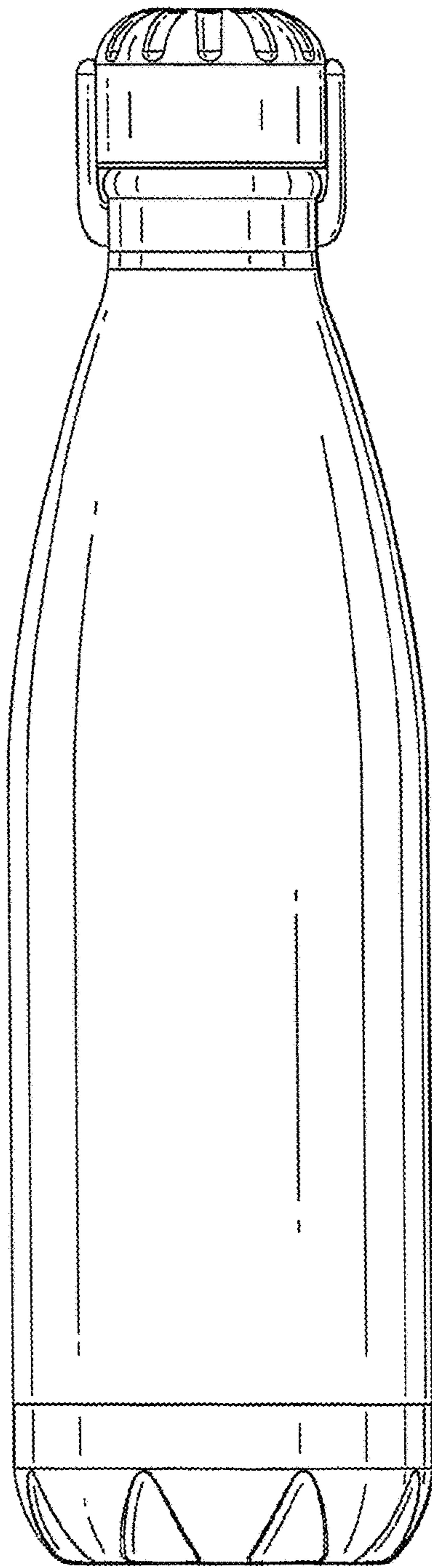

FIG. 3

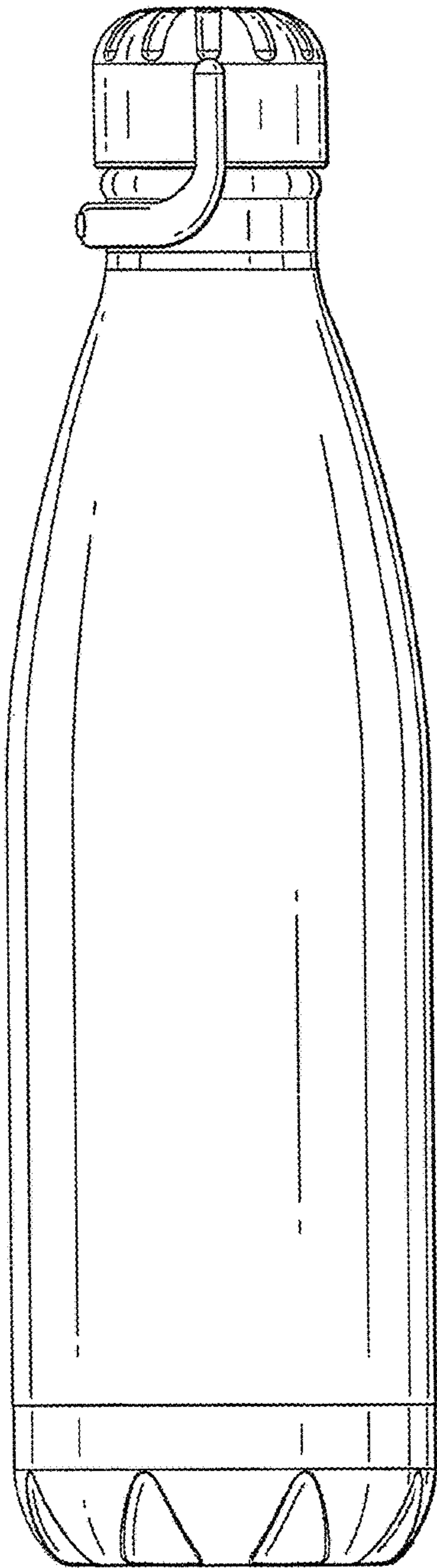

FIG. 4

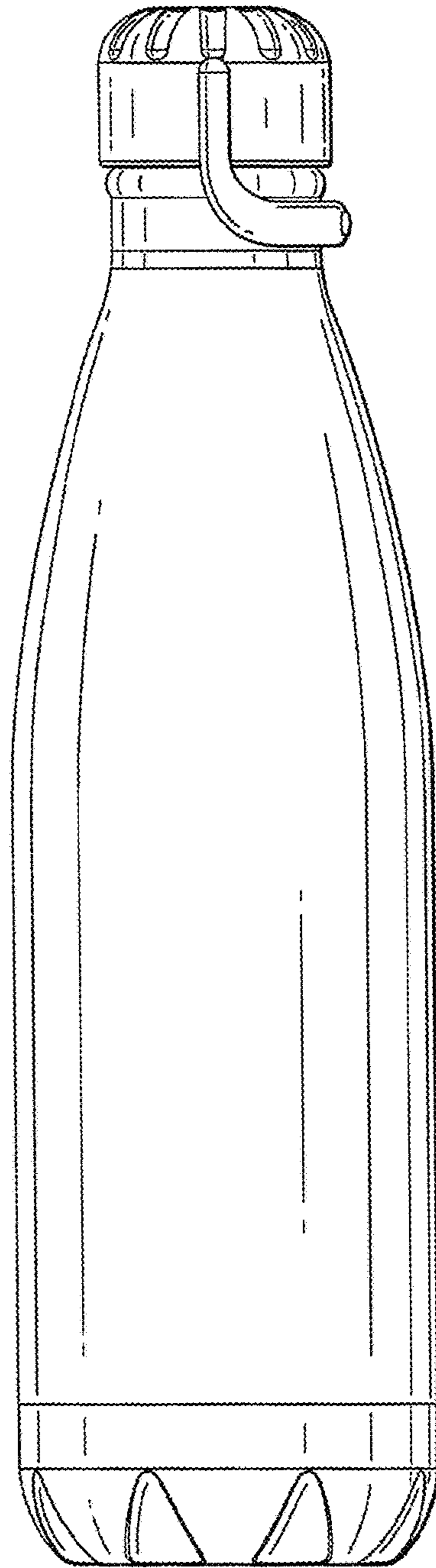

FIG. 5

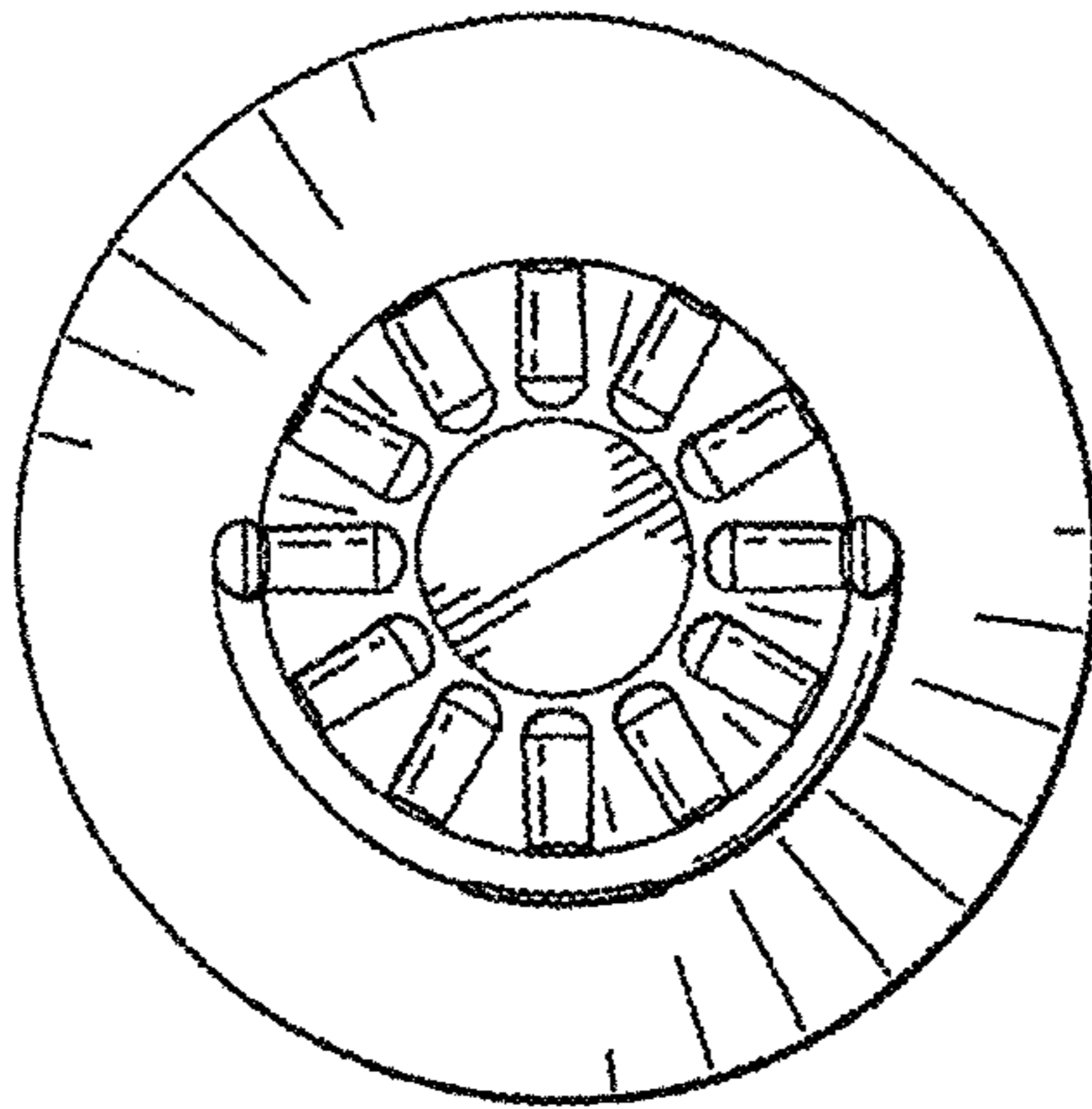

FIG. 6

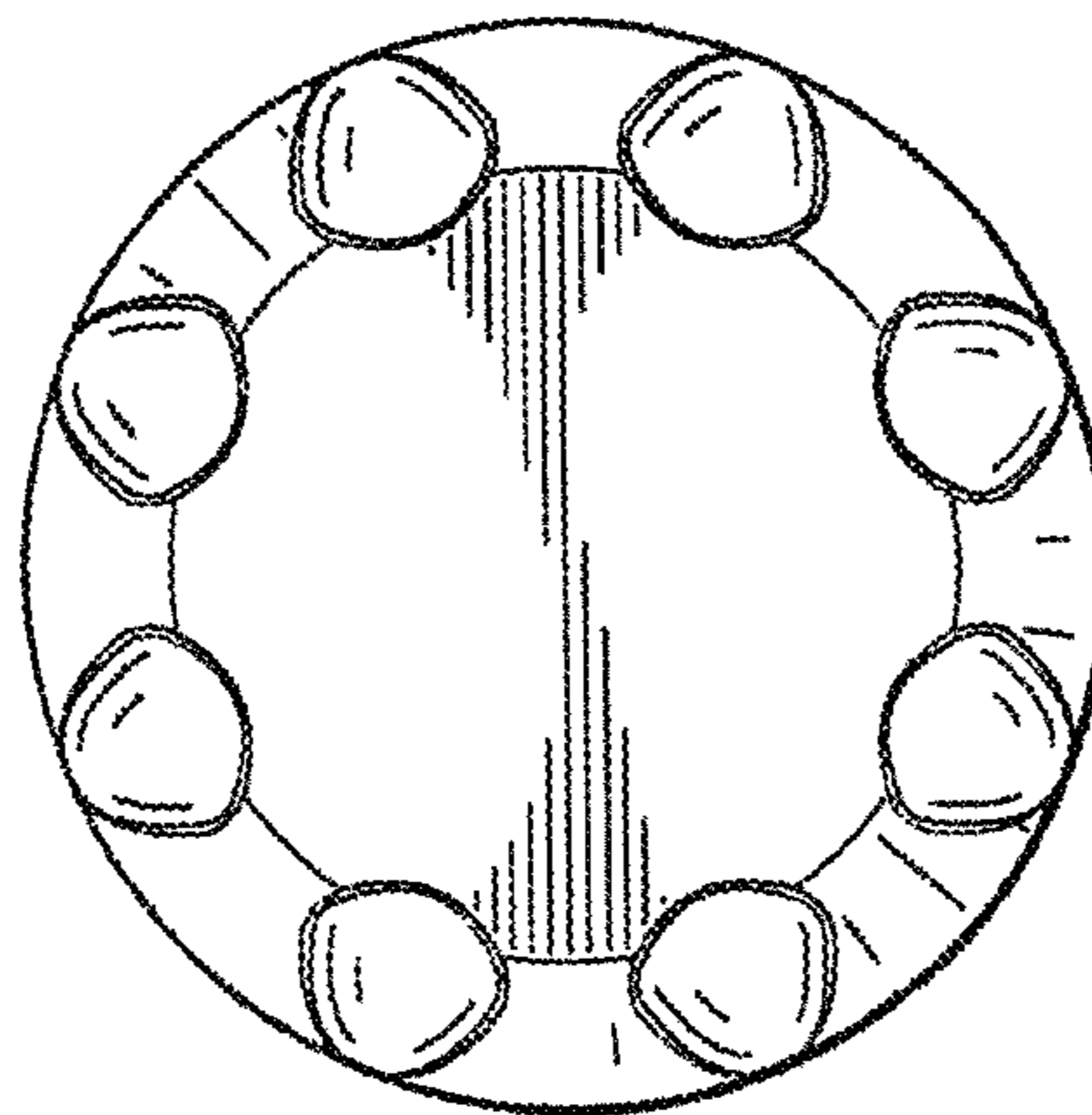

FIG. 7

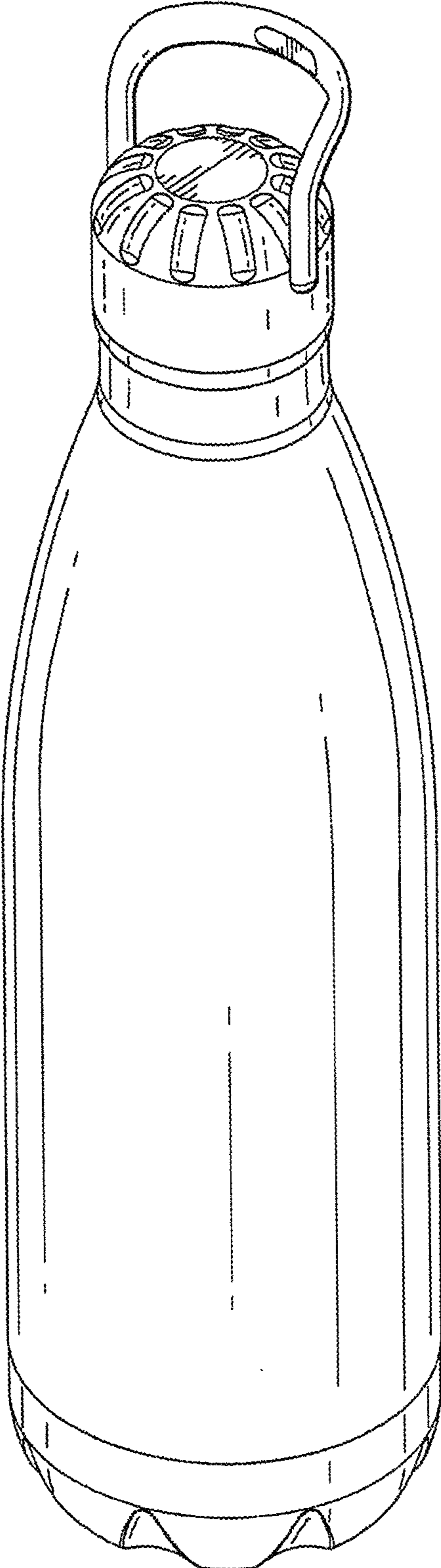

FIG. 8

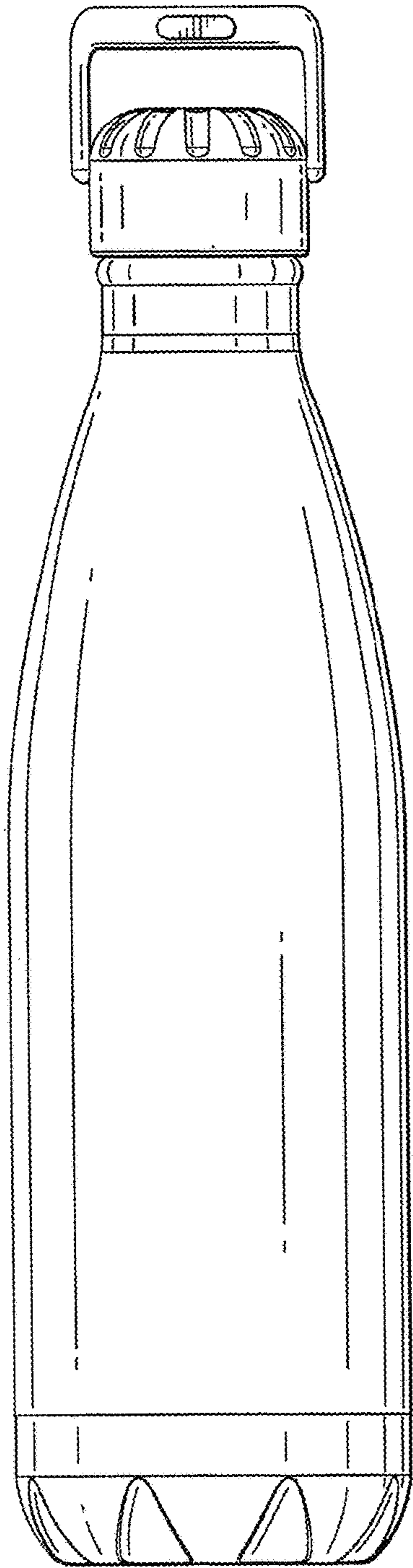

FIG. 9

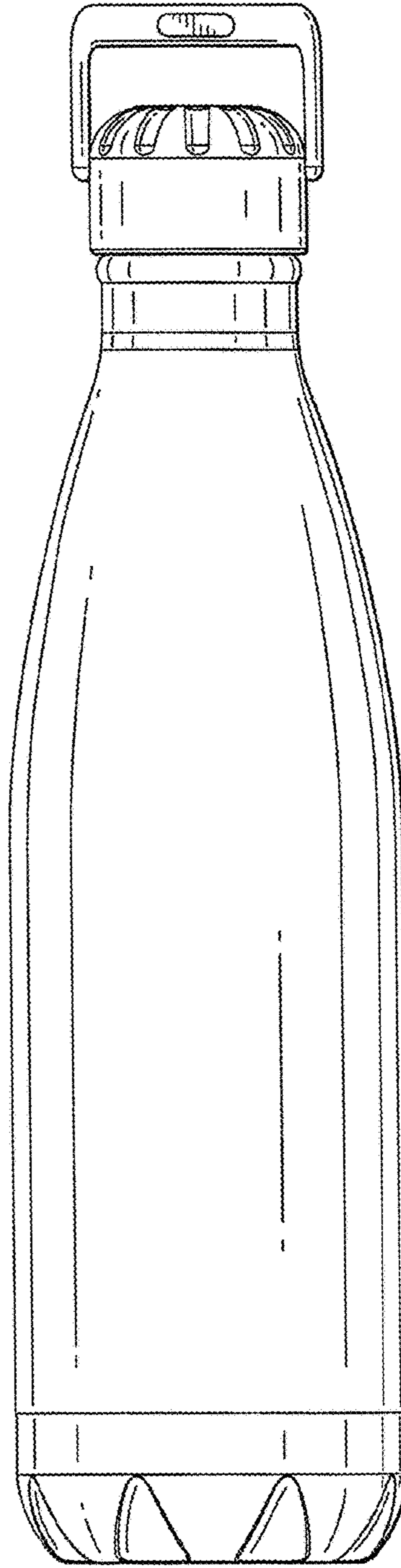

FIG. 10

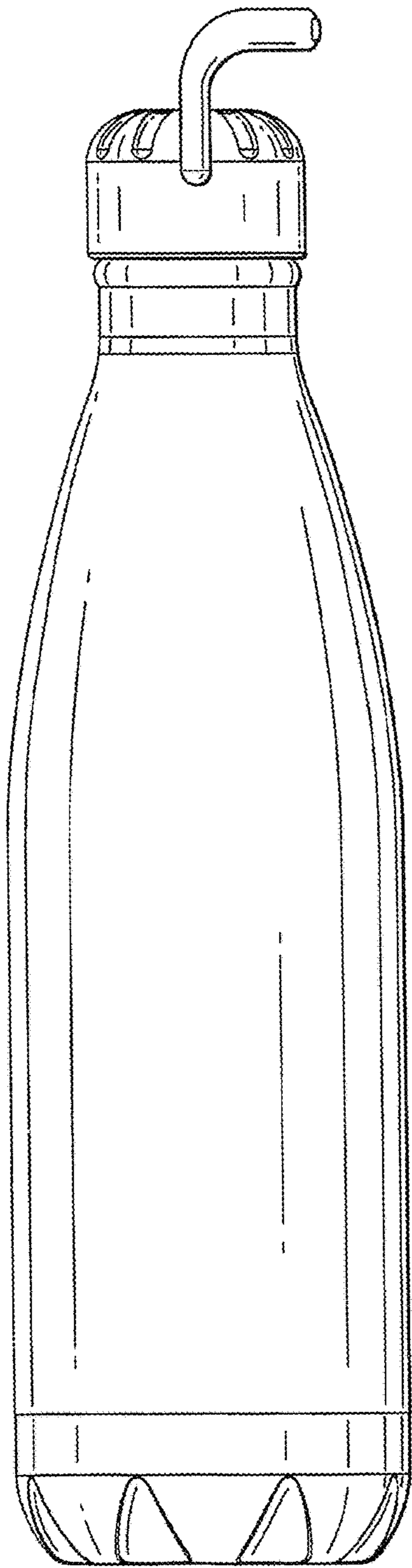

FIG. 11

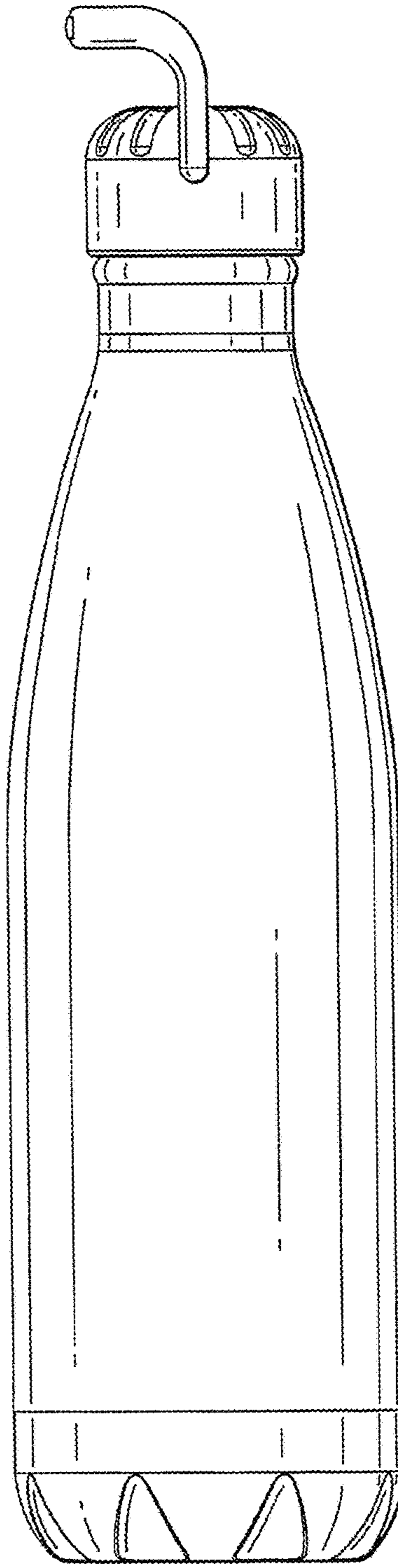

FIG. 12

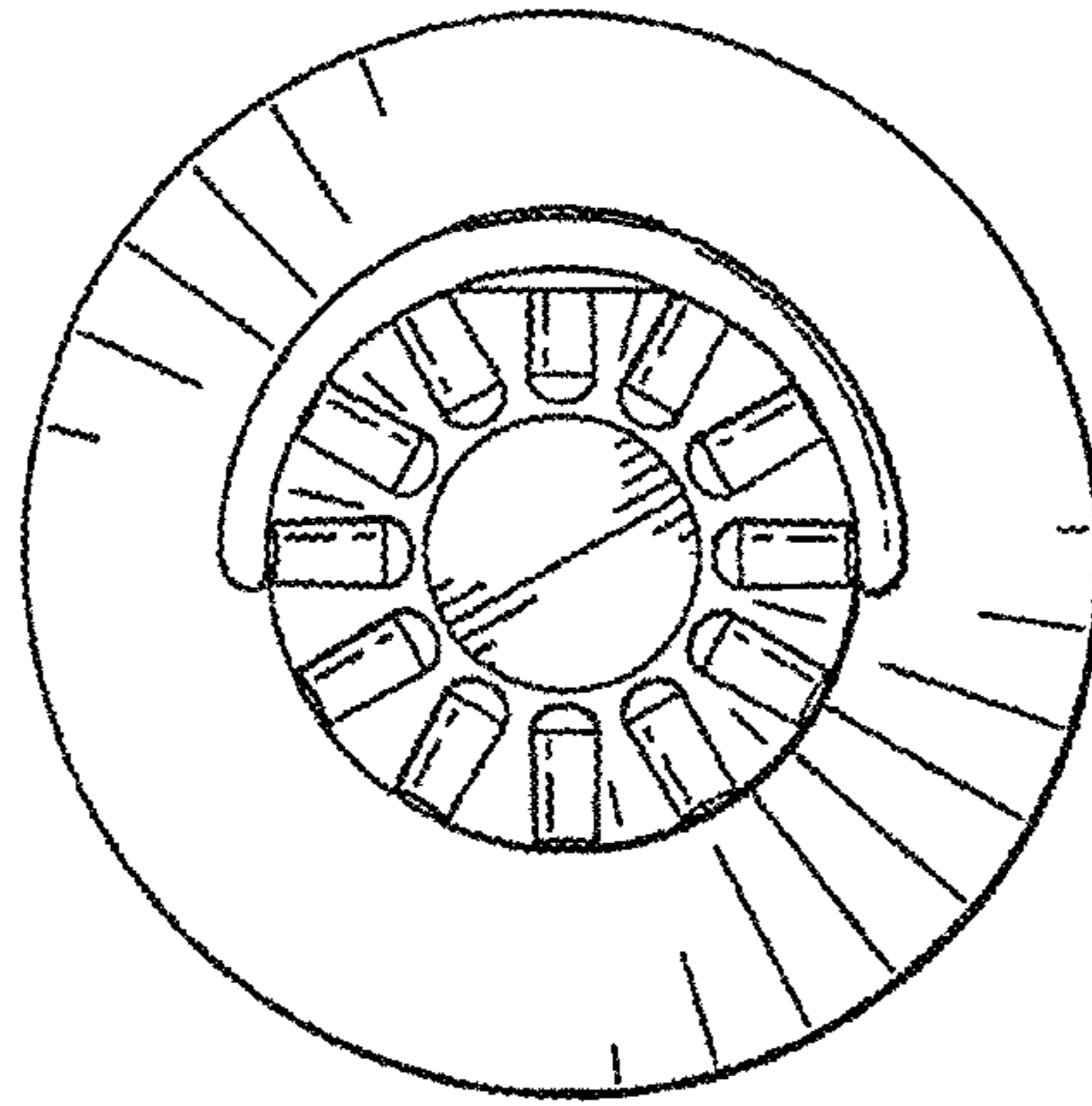

FIG. 13

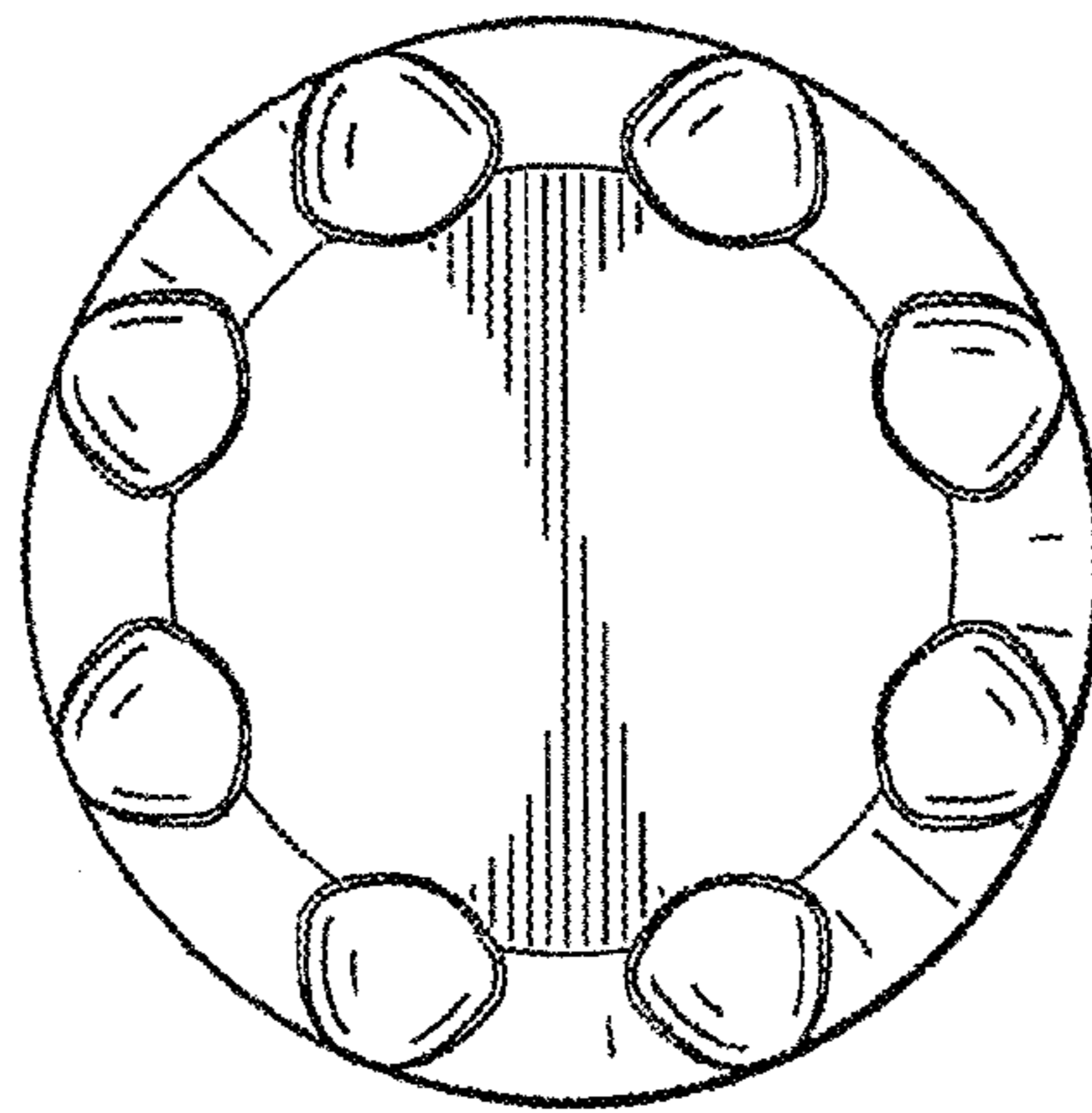

FIG. 14