



US00D831419S

(12) **United States Design Patent**  
**Liu**

(10) **Patent No.:** **US D831,419 S**

(45) **Date of Patent:** **\*\* Oct. 23, 2018**

(54) **KNIFE HANDLE**

(71) Applicant: **Yunxing Liu**, Irvine, CA (US)

(72) Inventor: **Yunxing Liu**, Irvine, CA (US)

(\*\*) Term: **15 Years**

(21) Appl. No.: **29/549,709**

(22) Filed: **Dec. 28, 2015**

(51) **LOC (11) Cl.** ..... **07-03**

(52) **U.S. Cl.**

USPC ..... **D7/401.2; D7/649**

(58) **Field of Classification Search**

USPC ..... D7/393-395, 401.2, 642-652, 693,  
D7/695-696; D8/93, 97-100, 107, 300,  
D8/321; D22/117-118

CPC ..... A01B 1/20; A01B 1/22; A22C 25/006;  
A47G 21/06; A47G 21/065; A61B  
17/3211; A61B 17/3213; B21D 53/64;  
B25G 3/36; B26B 1/00; B26B 1/08;  
B26B 1/10; B26B 3/00; B26B 3/02;  
B26B 3/03; B26B 3/04; B26B 3/06;  
B26B 5/00; B26B 5/001; B26B 5/007;  
B26B 7/00; B26B 7/005; B26B 9/00;  
B26B 9/02; B26B 11/00; B26B 11/006;  
B26B 17/00; B26B 17/006; B26B 29/02

See application file for complete search history.

(56) **References Cited**

**U.S. PATENT DOCUMENTS**

D661,545 S \* 6/2012 Chen ..... D7/401.2  
D688,913 S \* 9/2013 Lo ..... D7/401.2

D697,377 S \* 1/2014 Wandrup ..... D7/649  
D698,615 S \* 2/2014 Wandrup ..... D7/649  
D704,009 S \* 5/2014 Wandrup ..... D7/642  
D708,476 S \* 7/2014 Wandrup ..... D7/401.2  
D708,488 S \* 7/2014 Wandrup ..... D7/401.2  
D730,117 S \* 5/2015 Hiltenbrand ..... D7/401.2  
D751,862 S \* 3/2016 deBretton Gordon ..... D7/401.2  
D773,888 S \* 12/2016 Liu ..... D7/401.2  
D773,891 S \* 12/2016 Liu ..... D7/401.2  
D803,011 S \* 11/2017 Liu ..... D7/649

\* cited by examiner

*Primary Examiner* — Ricky Pham

(57) **CLAIM**

The ornamental design for a knife handle, as shown and described.

**DESCRIPTION**

FIG. 1 is a left side perspective view of the knife handle, the right-side being a mirror image, showing my design.

FIG. 2 is a left-side view of the knife handle thereof, the right-side being a mirror image.

FIG. 3 is a top view thereof.

FIG. 4 is a bottom view thereof.

FIG. 5 is an enlarged rear view thereof; and,

FIG. 6 is an enlarged front view thereof.

The broken line portions show unclaimed subject matter only and form no part of the claimed design.

**1 Claim, 3 Drawing Sheets**

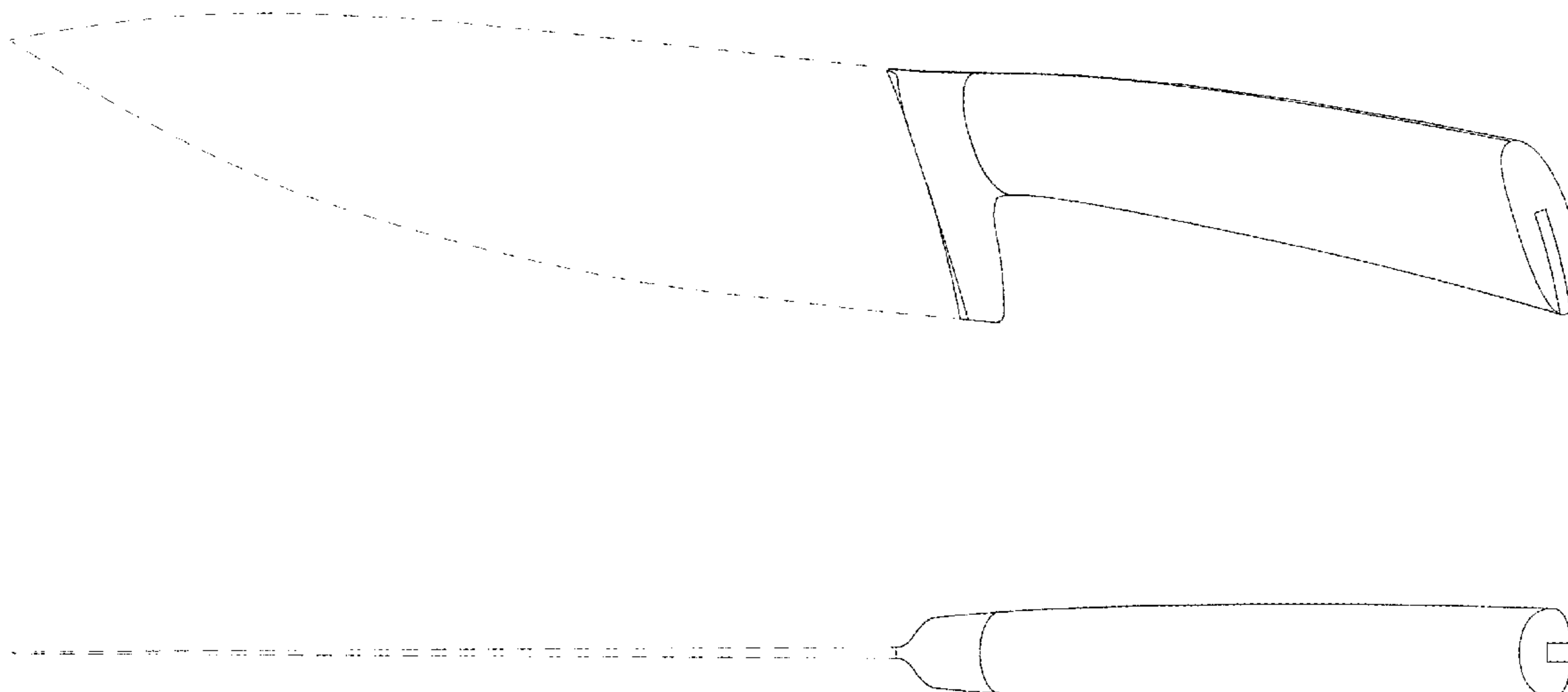

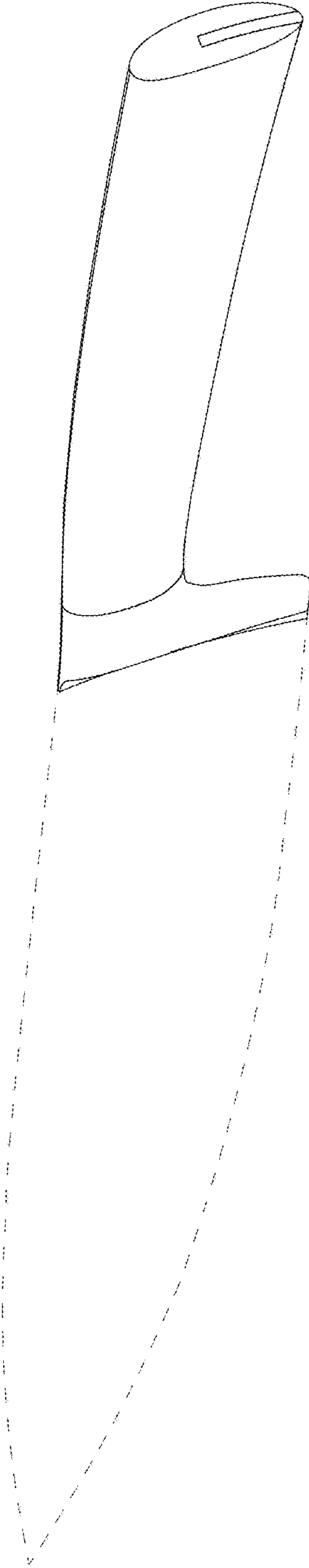

Fig. 1

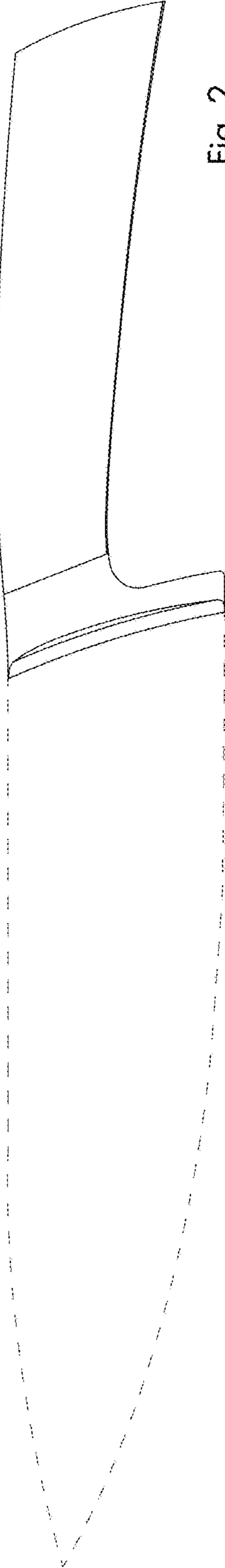

Fig. 2

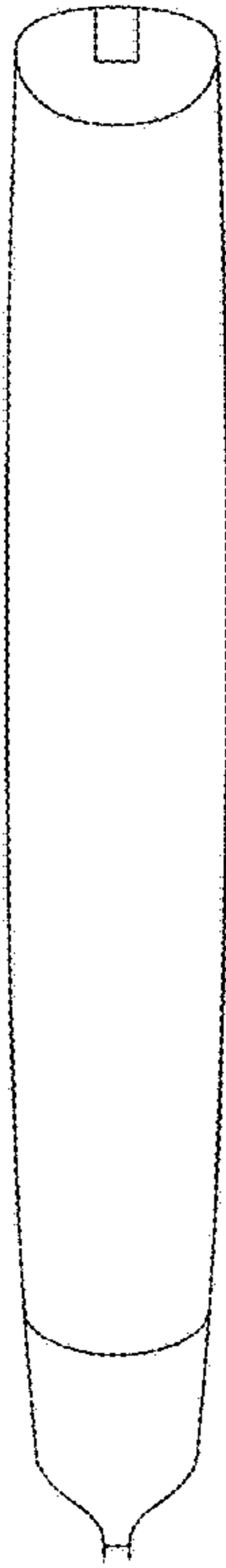

Fig. 3

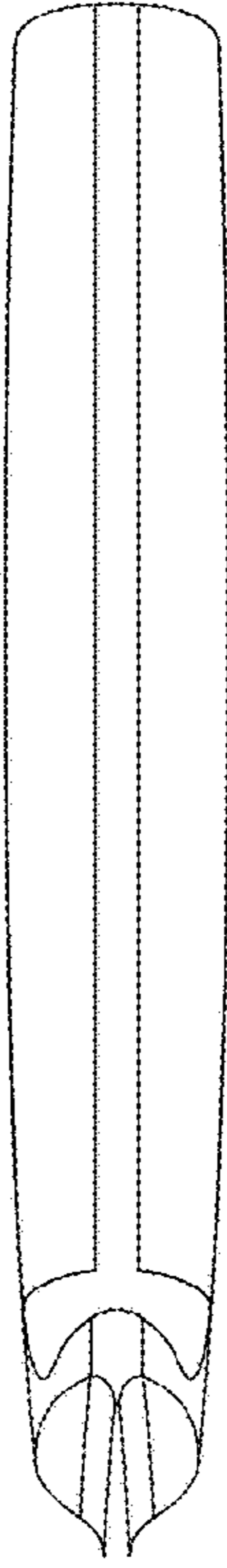

Fig. 4

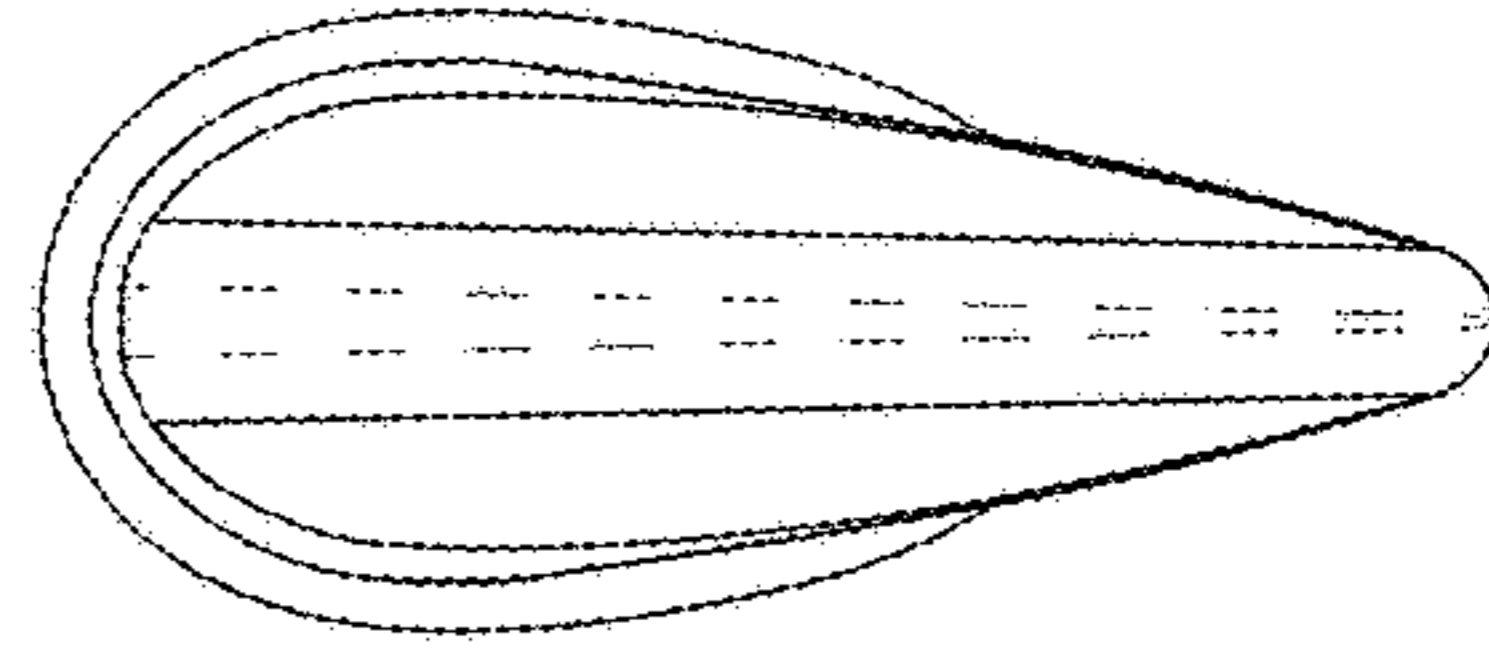

Fig. 6

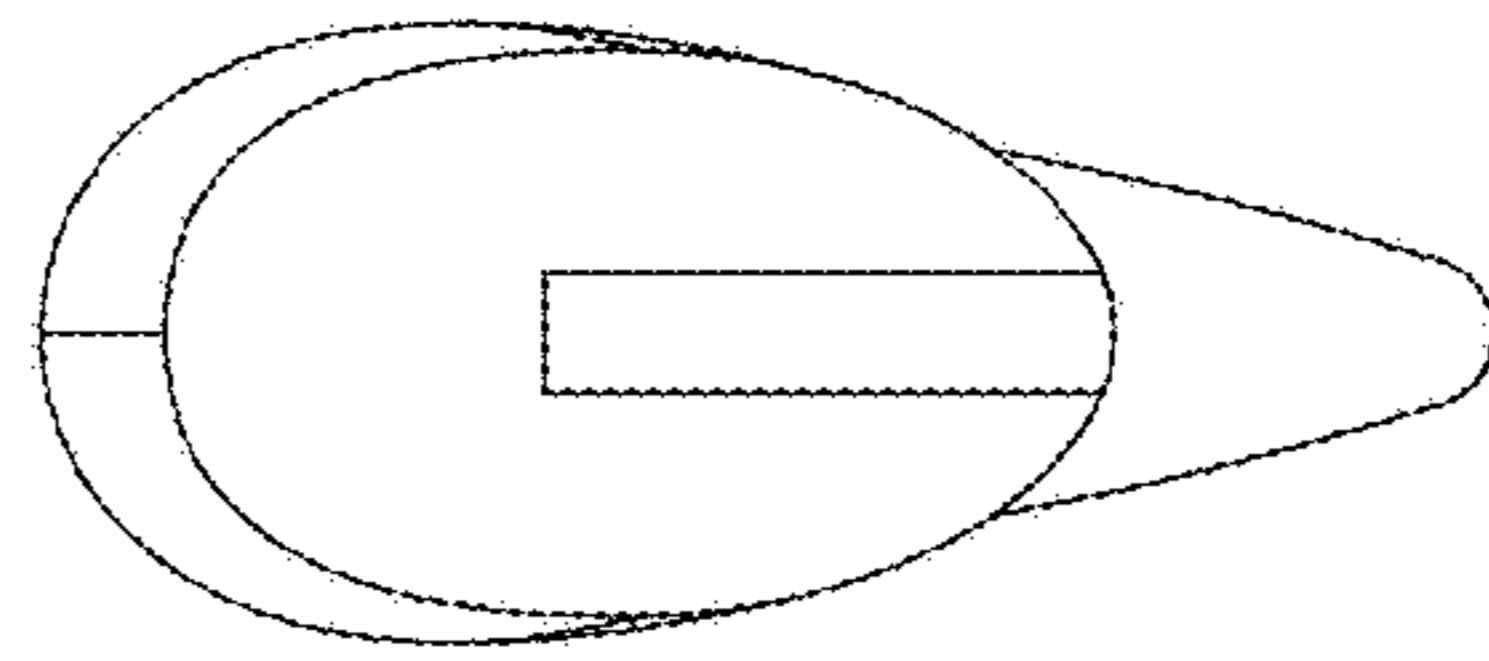

Fig. 5