



US00D831378S

(12) **United States Design Patent** (10) **Patent No.:** **US D831,378 S**
Crowe (45) **Date of Patent:** **** Oct. 23, 2018**

(54) **WEAPON RACK FOR A TREE STAND** 8,322,068 B2 * 12/2012 Wilson F41A 29/00
42/90
(71) Applicant: **John A. Crowe**, Owensboro, KY (US) D719,375 S 12/2014 Cox
D748,205 S 1/2016 Selph
(72) Inventor: **John A. Crowe**, Owensboro, KY (US) D770,803 S 11/2016 Parsons
D771,214 S 11/2016 Parsons
D813,567 S * 3/2018 Browning D6/552
(**) Term: **15 Years** 2007/0169391 A1 7/2007 Carpenter
2010/0219302 A1 9/2010 Krasnicki

(21) Appl. No.: **29/610,237**

(22) Filed: **Jul. 11, 2017**

(51) **LOC (11) Cl.** **08-08**

(52) **U.S. Cl.**
USPC **D6/552**

(58) **Field of Classification Search**
USPC D6/552, 553, 567; D22/109, 108; 42/99,
42/94; 89/37.04; 211/13.1, 60.1, 64;
248/206.5, 309.4, 467, 537, 683, 309.1;
D3/262
CPC F41A 23/18; B60R 7/14
See application file for complete search history.

(56) **References Cited**

U.S. PATENT DOCUMENTS

- D203,680 S 2/1966 Allison
- 3,964,613 A * 6/1976 Anderson, Jr. F41A 23/00
211/64
- 4,449,314 A * 5/1984 Sorensen F41A 23/00
211/64
- 5,058,302 A 10/1991 Minneman
- 5,666,757 A 9/1997 Helmstadter
- D406,483 S * 3/1999 Bast D6/552
- D406,629 S 3/1999 Banfill
- 5,913,668 A 6/1999 Messer
- 6,158,159 A 12/2000 Zekas
- D471,248 S 3/2003 Jacobs
- D543,604 S * 5/2007 Minneman D22/108
- 7,584,690 B2 9/2009 Cauley
- D643,658 S 8/2011 Vining
- D651,795 S * 1/2012 Buie, II D3/262

OTHER PUBLICATIONS

DIY Shooting Rest. Instructions [online]. © 2017 Autodesk, Inc.
[Retrieved on Mar. 6, 2017] <URL: <http://www.instructables.com/id/DIY-Gun-Rest/>>.

* cited by examiner

Primary Examiner — Wan Laymon
Assistant Examiner — Mark Booker
(74) *Attorney, Agent, or Firm* — Cramer Patent & Design,
PLLC; Aaron R. Cramer

(57) **CLAIM**

The ornamental design for a weapon rack for a tree stand, as shown and described.

DESCRIPTION

FIG. 1 is a perspective top front right view of a weapon rack for a tree stand, showing my new design;
FIG. 2 is a perspective top rear left view thereof;
FIG. 3 is a front elevation view thereof;
FIG. 4 is a rear elevation view thereof;
FIG. 5 is a left elevation view thereof;
FIG. 6 is a right elevation view thereof;
FIG. 7 is a top plan view thereof; and,
FIG. 8 is a bottom plan view thereof.

1 Claim, 8 Drawing Sheets

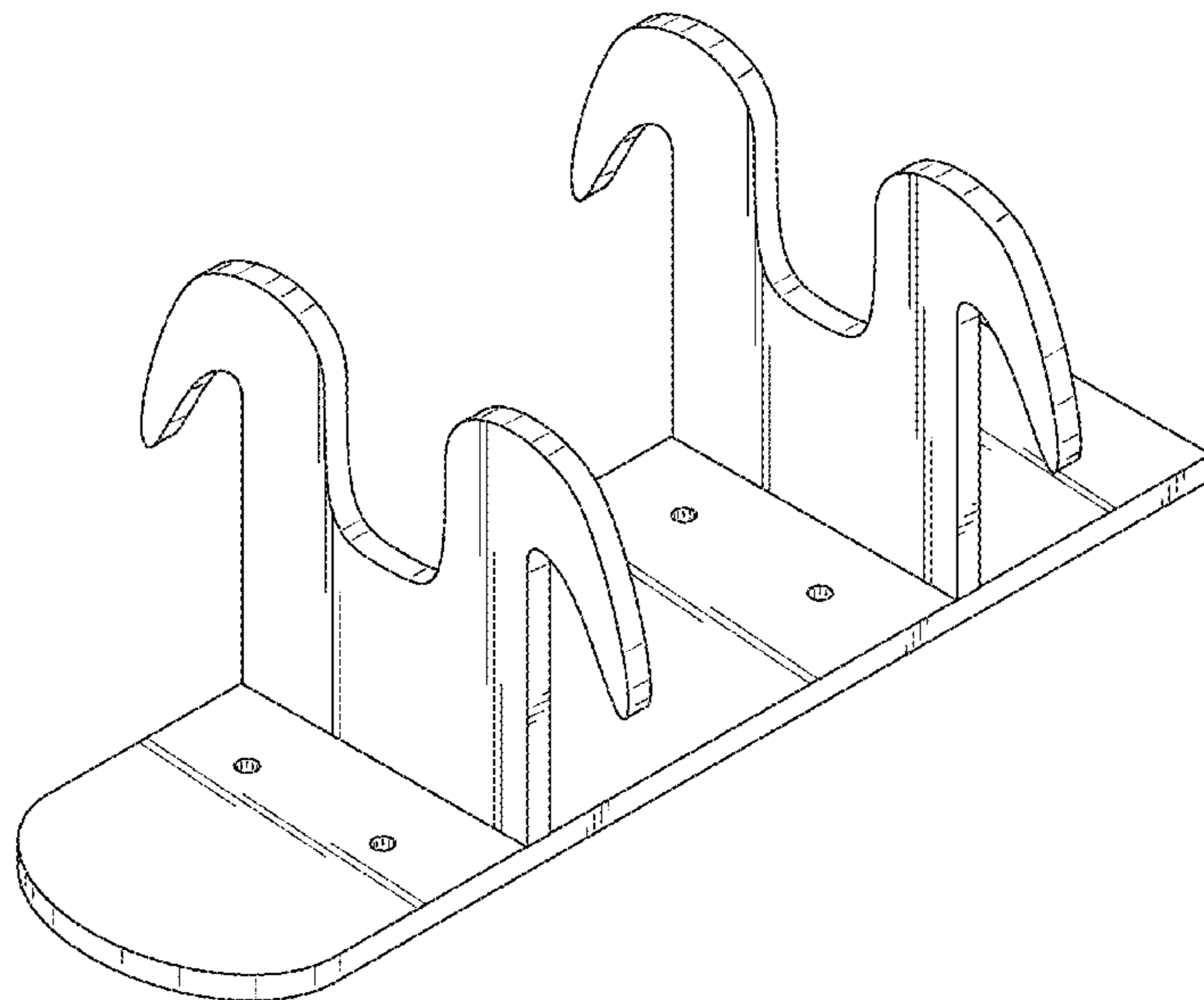

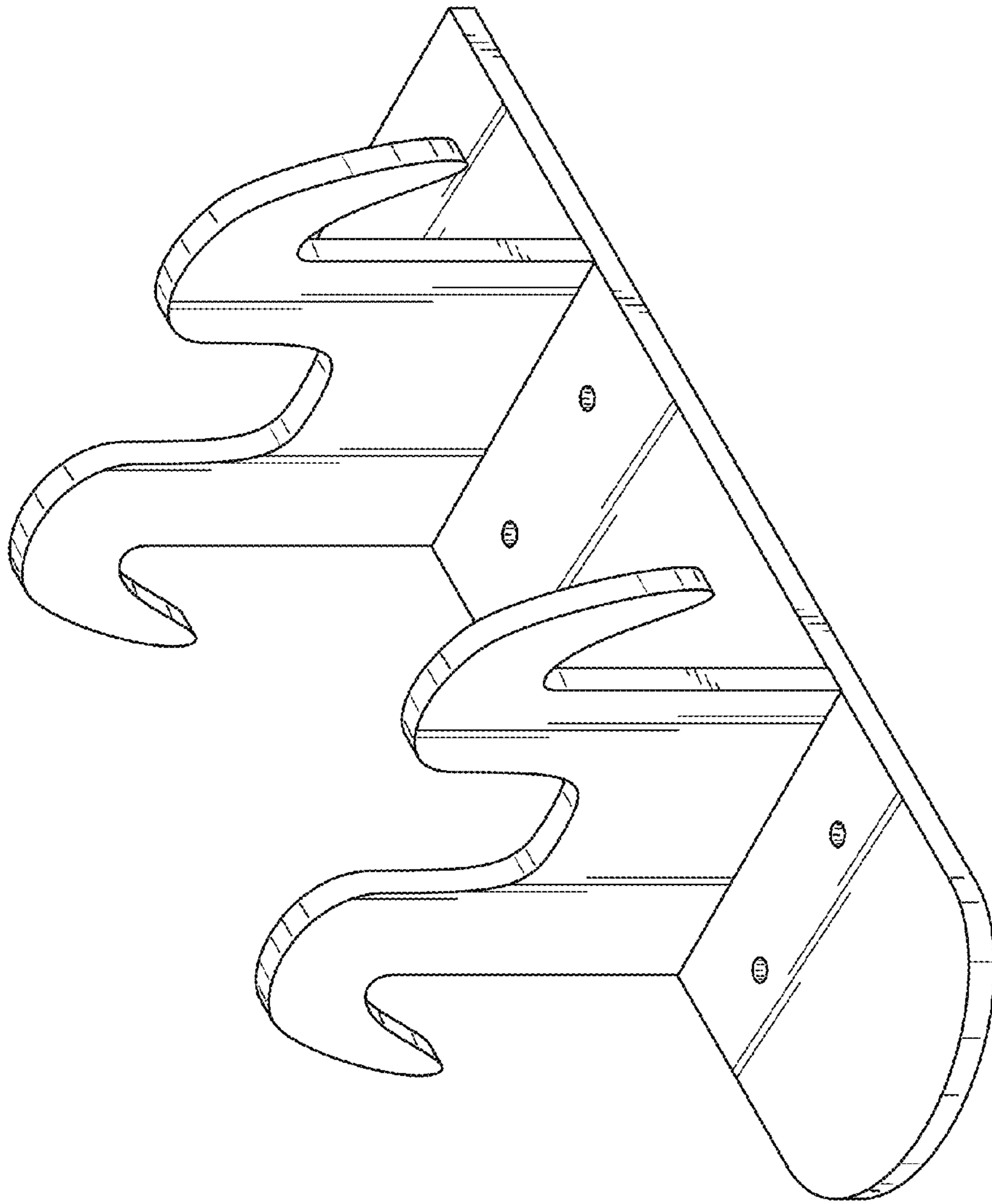

FIG. 1

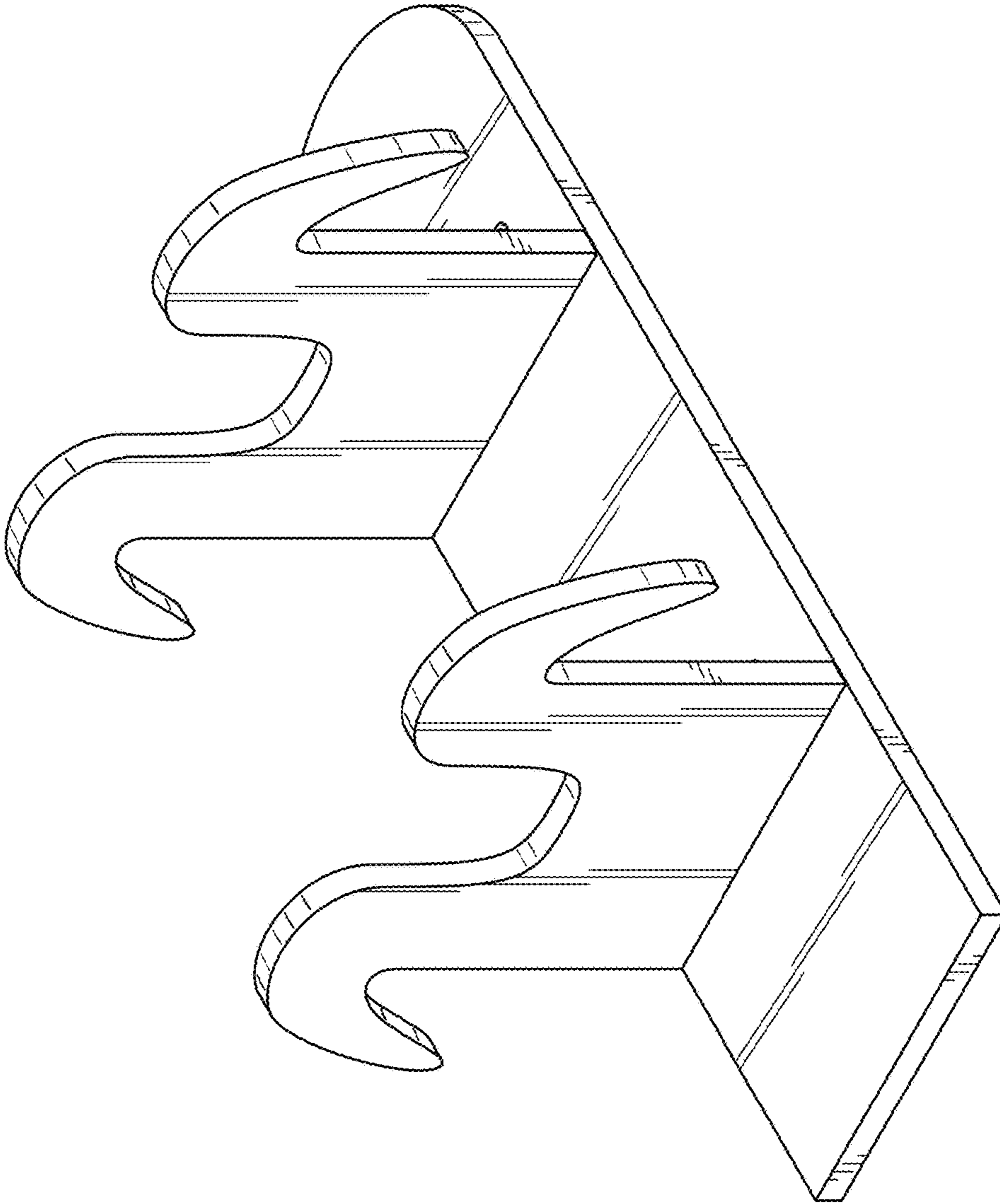

FIG. 2

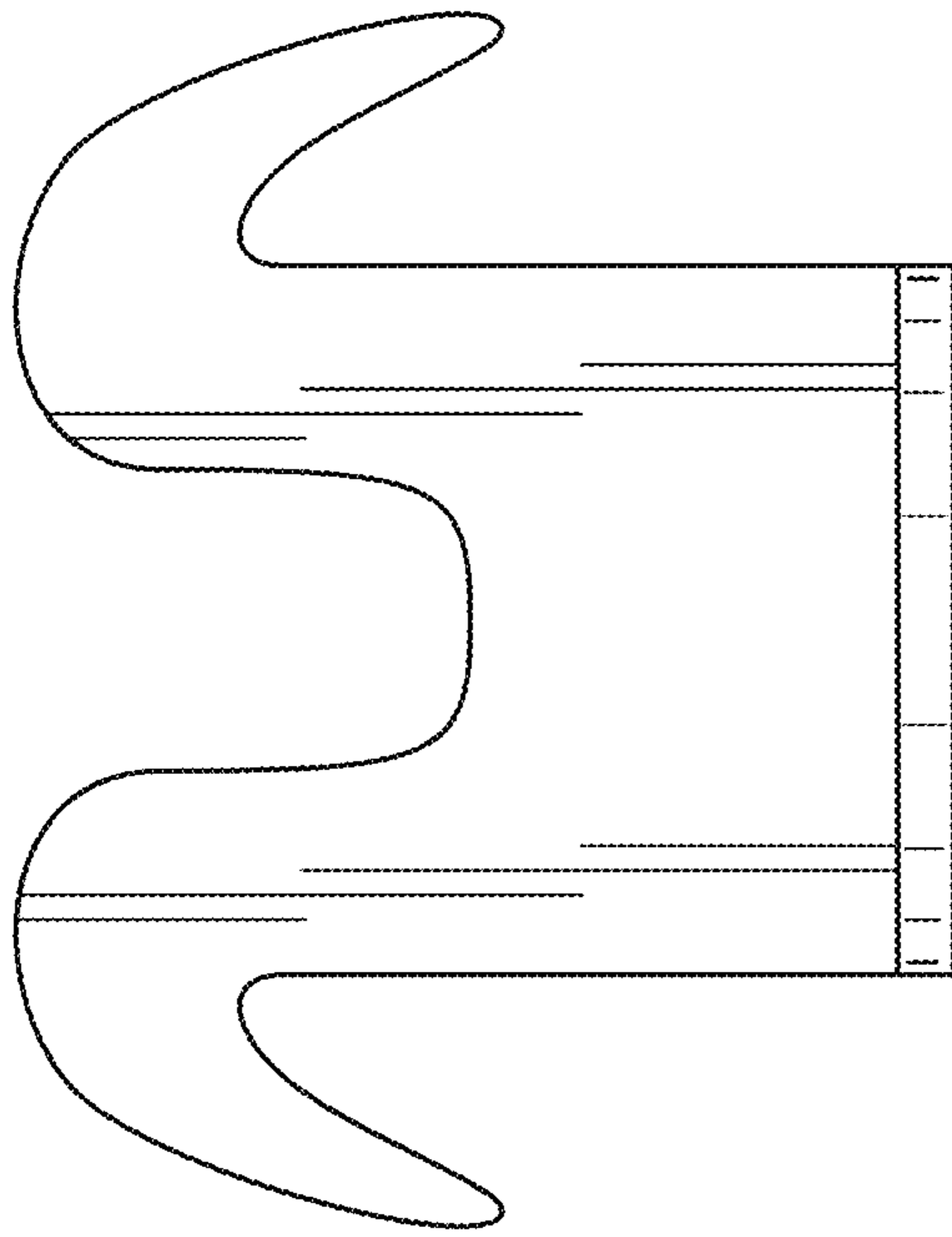

FIG. 3

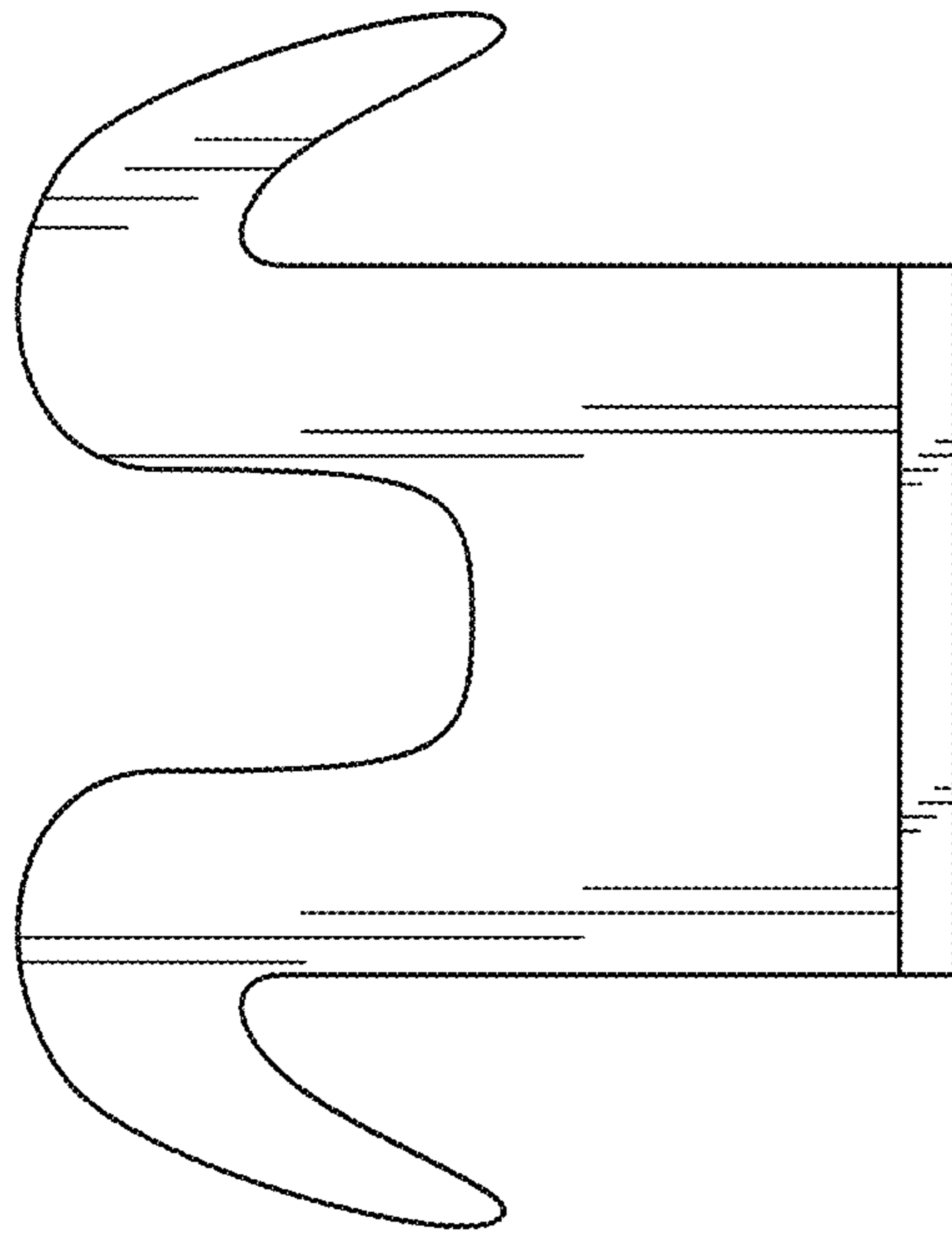

FIG. 4

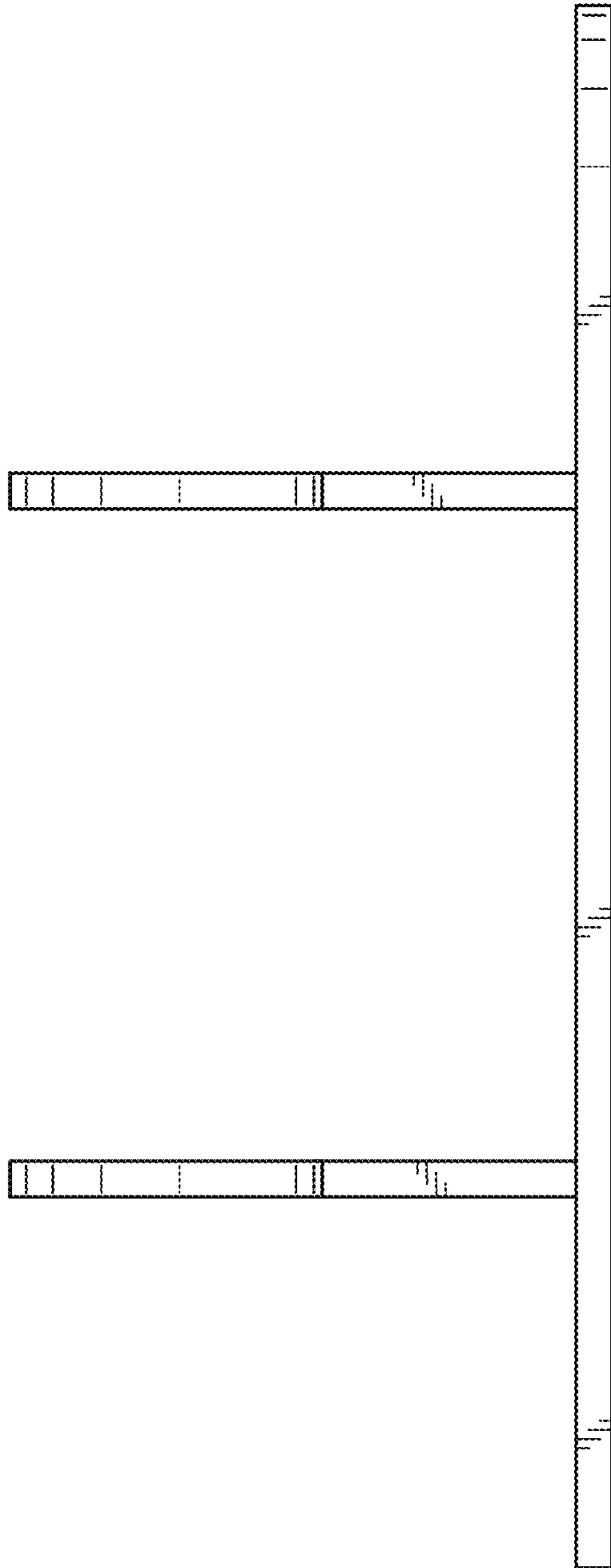

FIG. 5

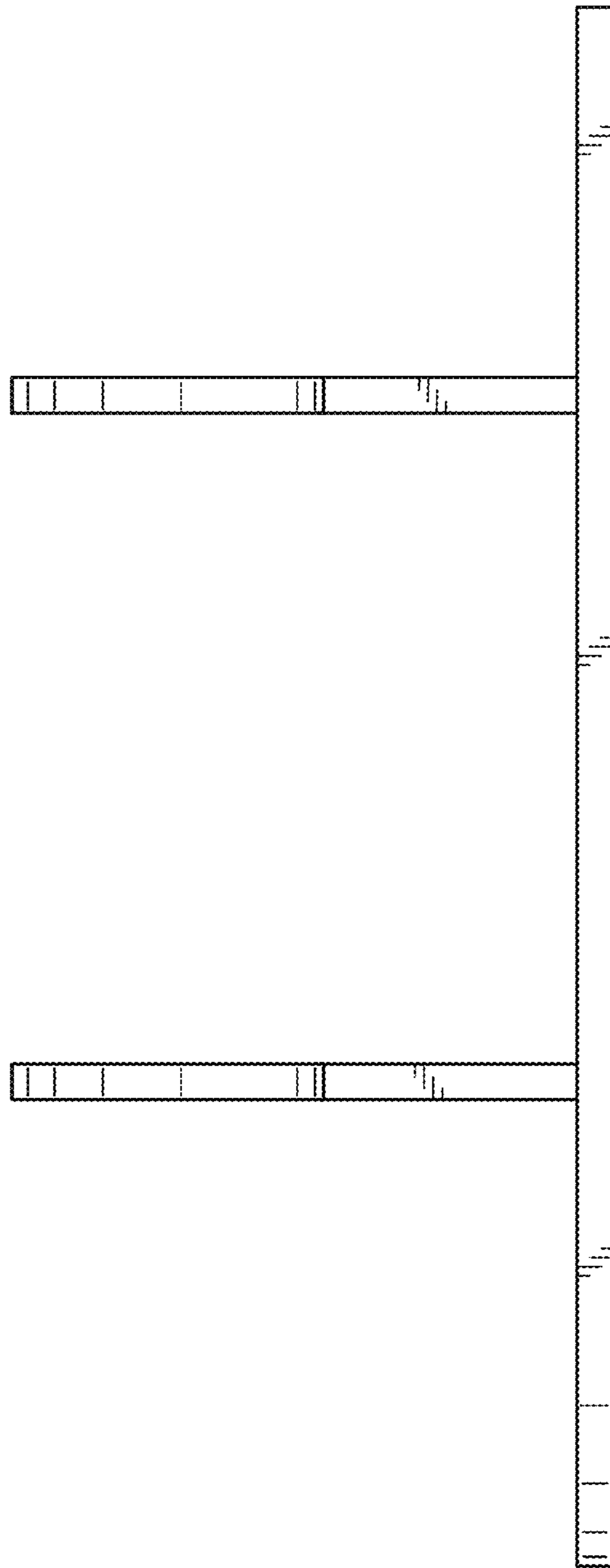

FIG. 6

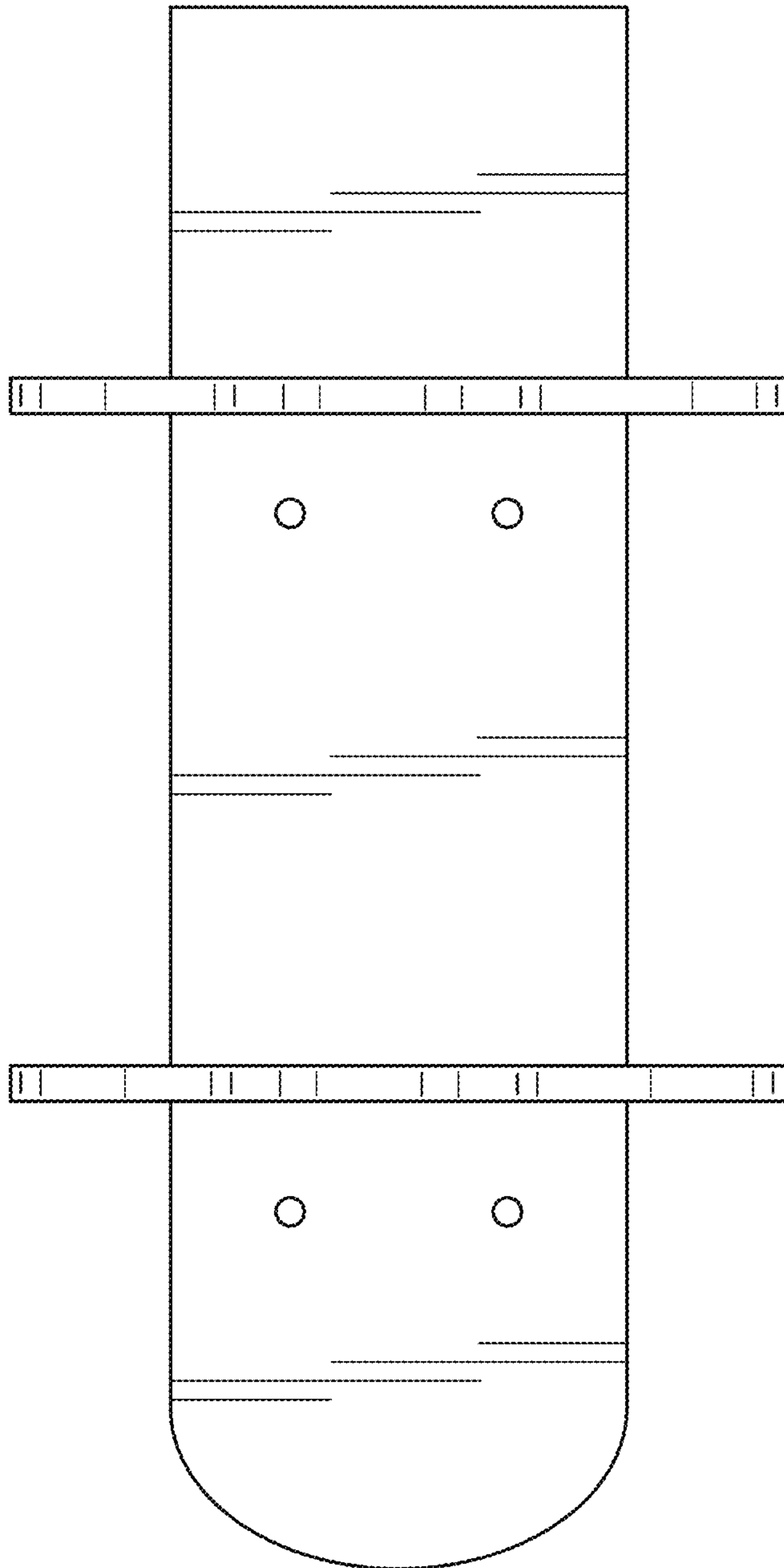

FIG. 7

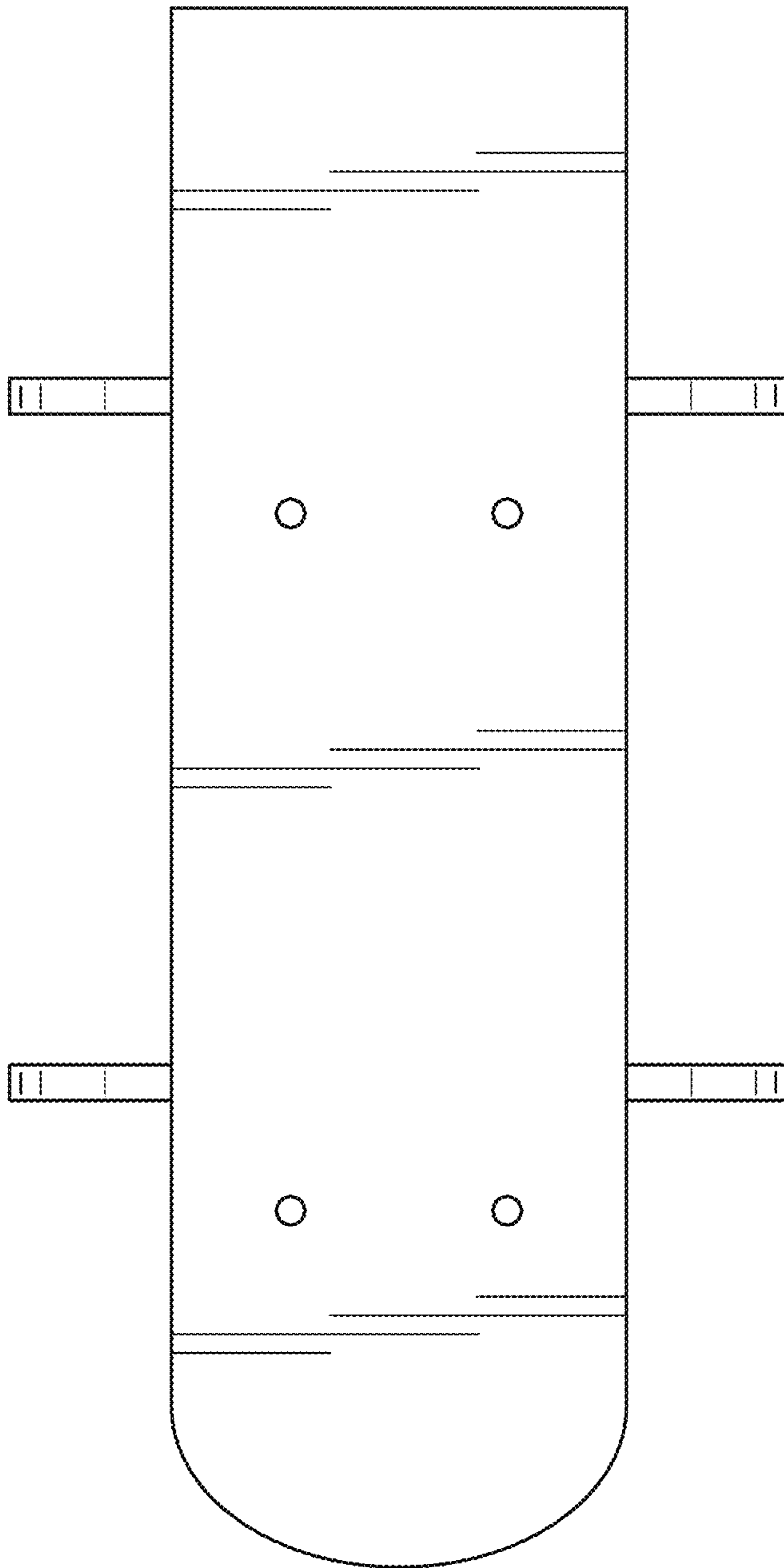

FIG. 8