



US00D831355S

(12) **United States Design Patent**  
**Epain**

(10) **Patent No.:** **US D831,355 S**

(45) **Date of Patent:** **\*\* Oct. 23, 2018**

(54) **BAG**

D797,445 S \* 9/2017 Boroski ..... D3/243

(71) Applicant: **MAPED**, Argonay (FR)

\* cited by examiner

(72) Inventor: **Didier Epain**, Poisy (FR)

*Primary Examiner* — Holly H Baynham

(73) Assignee: **MAPED**, Argonay (FR)

(74) *Attorney, Agent, or Firm* — Cantor Colburn LLP

(\*\*) Term: **15 Years**

(57) **CLAIM**

(21) Appl. No.: **29/601,033**

I claim, the ornamental design for a bag, as shown and described.

(22) Filed: **Apr. 18, 2017**

**DESCRIPTION**

(51) **LOC (11) Cl.** ..... **03-01**

(52) **U.S. Cl.**  
USPC ..... **D3/318**

(58) **Field of Classification Search**  
USPC ..... D3/232–233, 240–243, 245–246, 318  
CPC ..... A45C 1/024; A45C 3/06  
See application file for complete search history.

FIG. 1 is a perspective view of a bag, showing my new design;  
FIG. 2 is a front elevation view thereof;  
FIG. 3 is a rear elevation view thereof;  
FIG. 4 is a left side elevation view thereof;  
FIG. 5 is a right side elevation view thereof;  
FIG. 6 is a top plan view thereof;  
FIG. 7 is a bottom plan view thereof; and,  
FIG. 8 is a perspective view thereof in an open position.  
The broken lines showing portions of a handbag strap are for the purposes of illustrating environment and form no part of the claimed design.

(56) **References Cited**

**U.S. PATENT DOCUMENTS**

D125,522 S \* 2/1941 Nathan ..... 150/117  
D715,539 S \* 10/2014 Bauer ..... D3/232  
D785,933 S \* 5/2017 Louboutin ..... D3/243

**1 Claim, 6 Drawing Sheets**

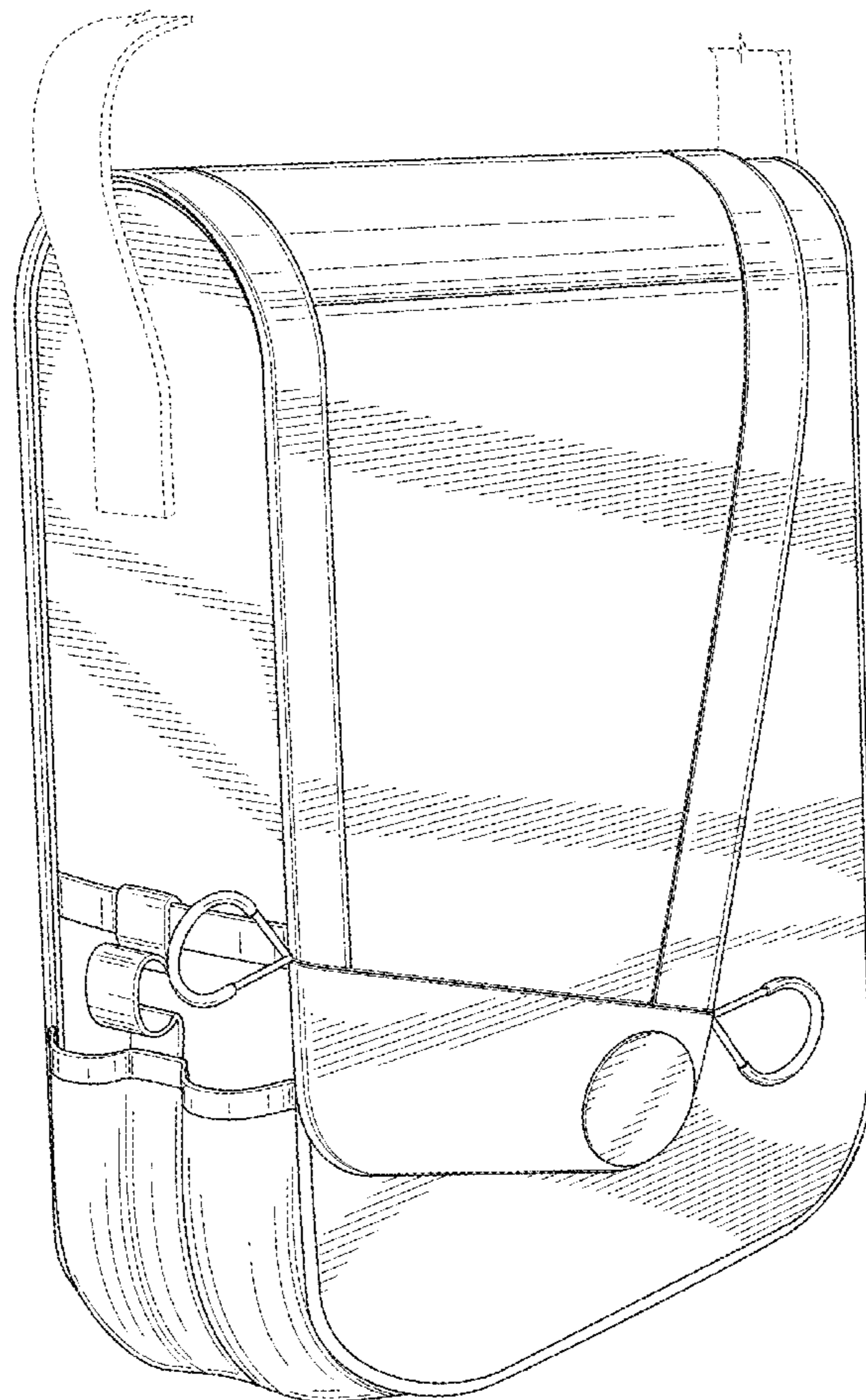

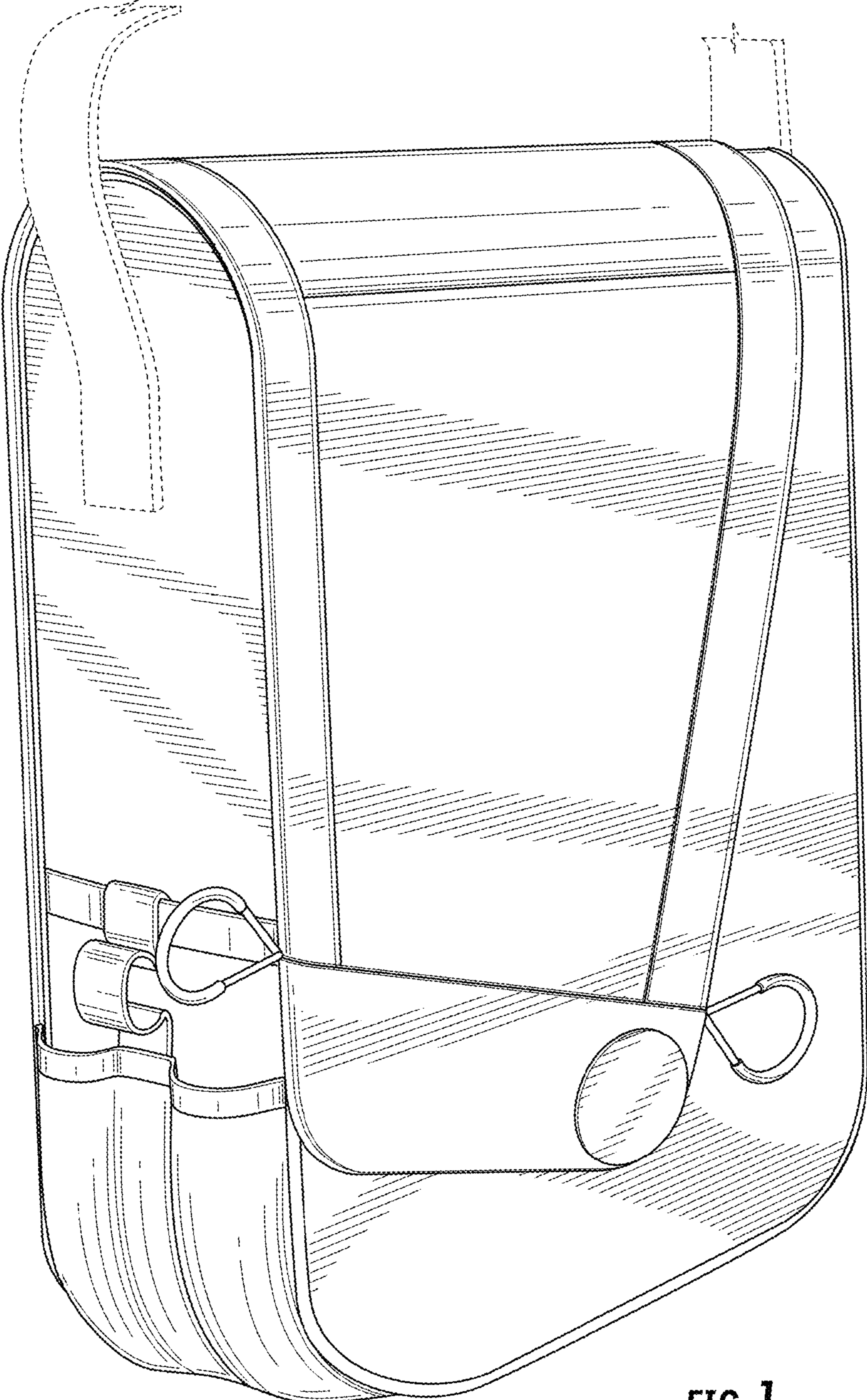

FIG. 1

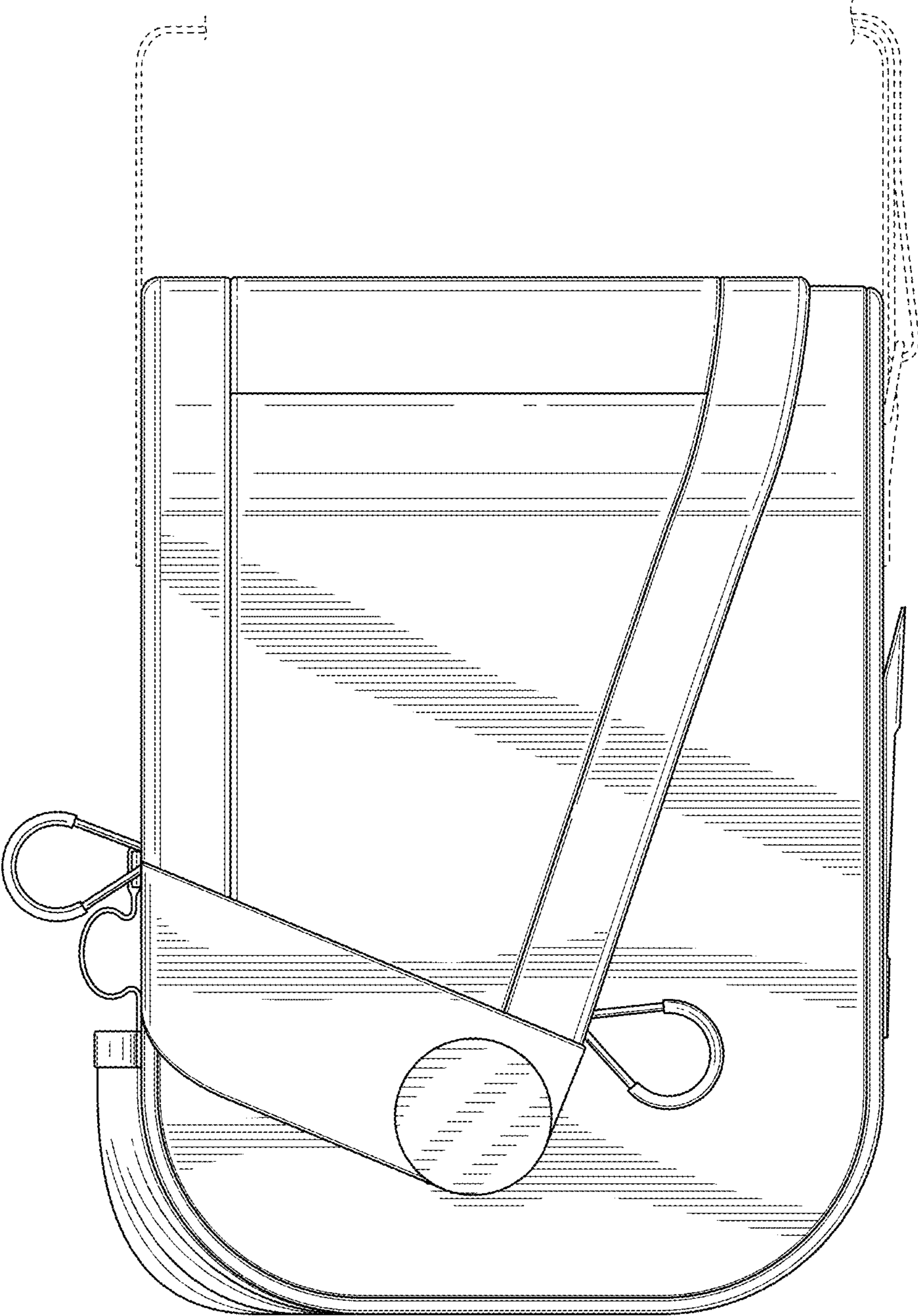
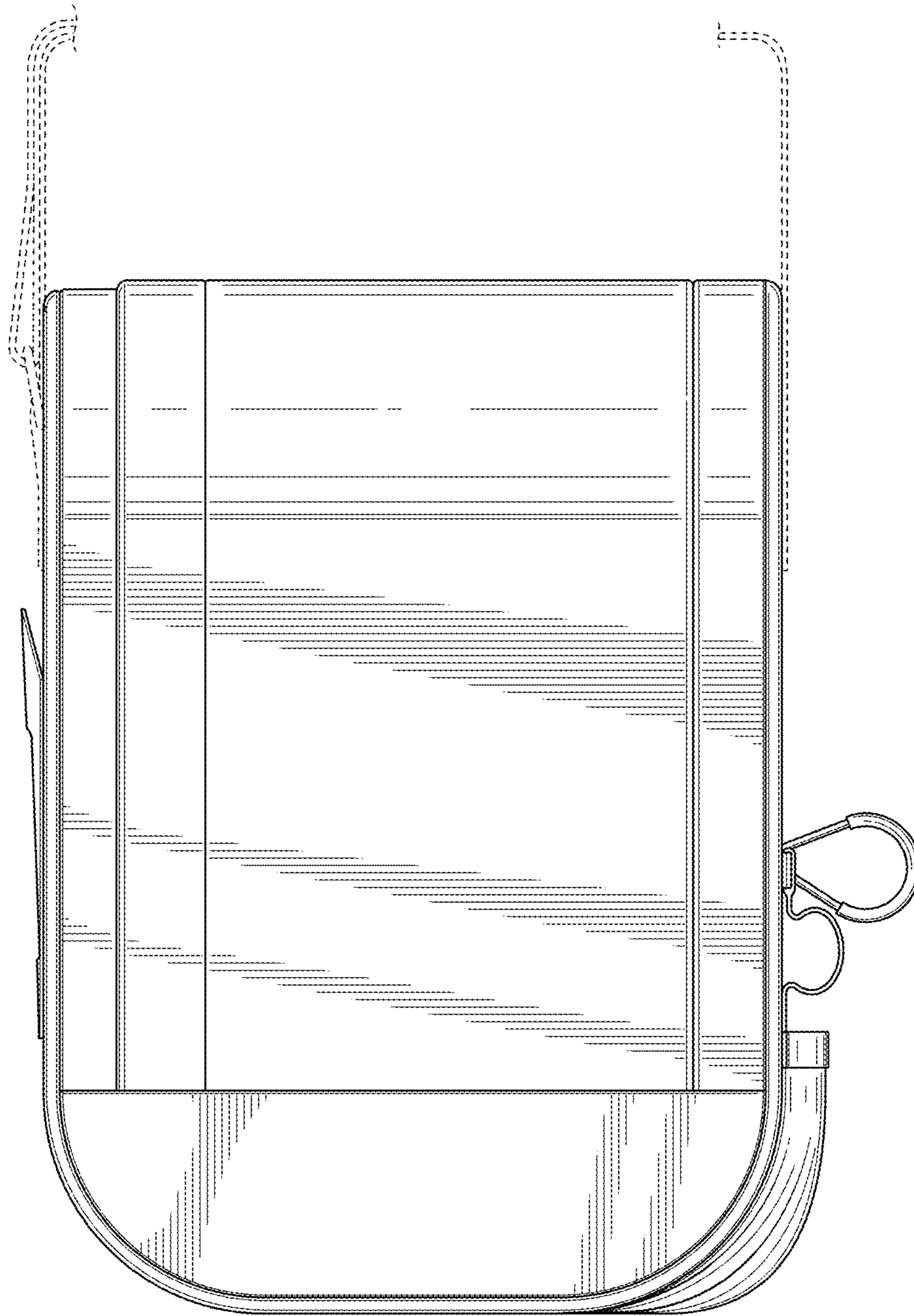

FIG. 2





**FIG. 3**

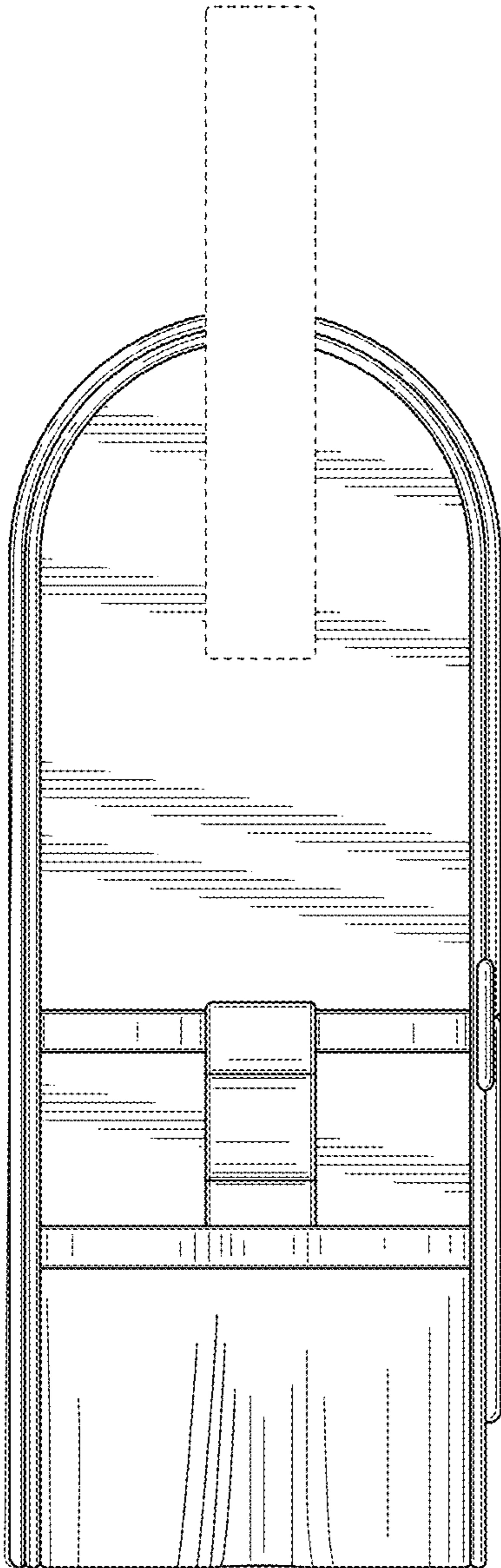

FIG. 4

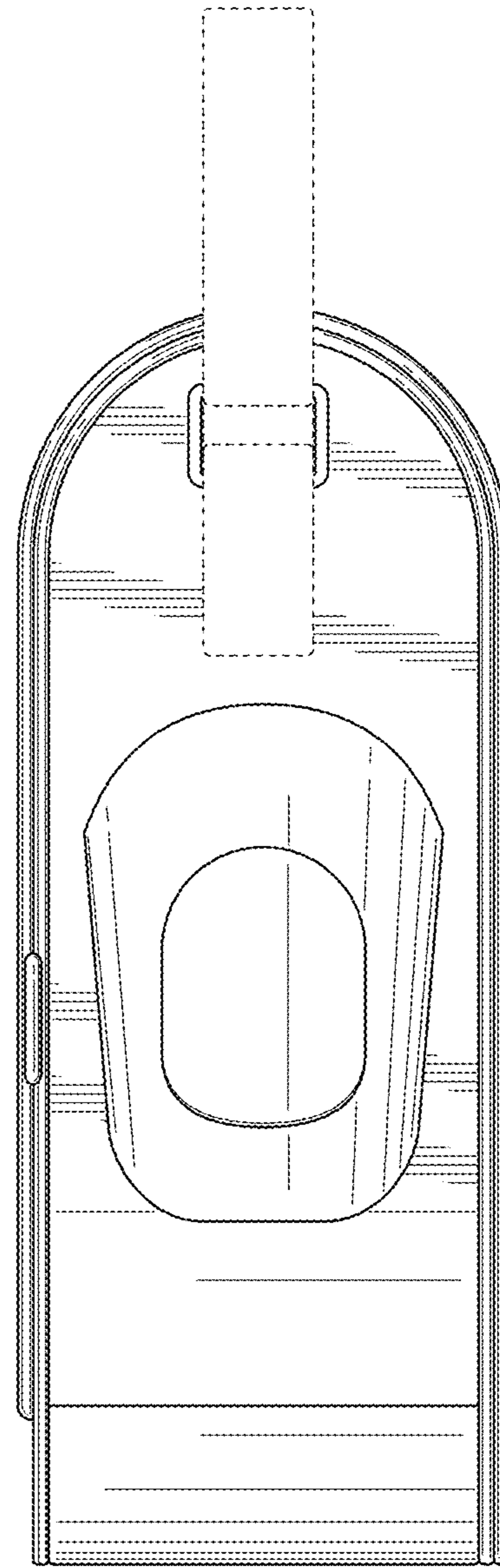

FIG. 5

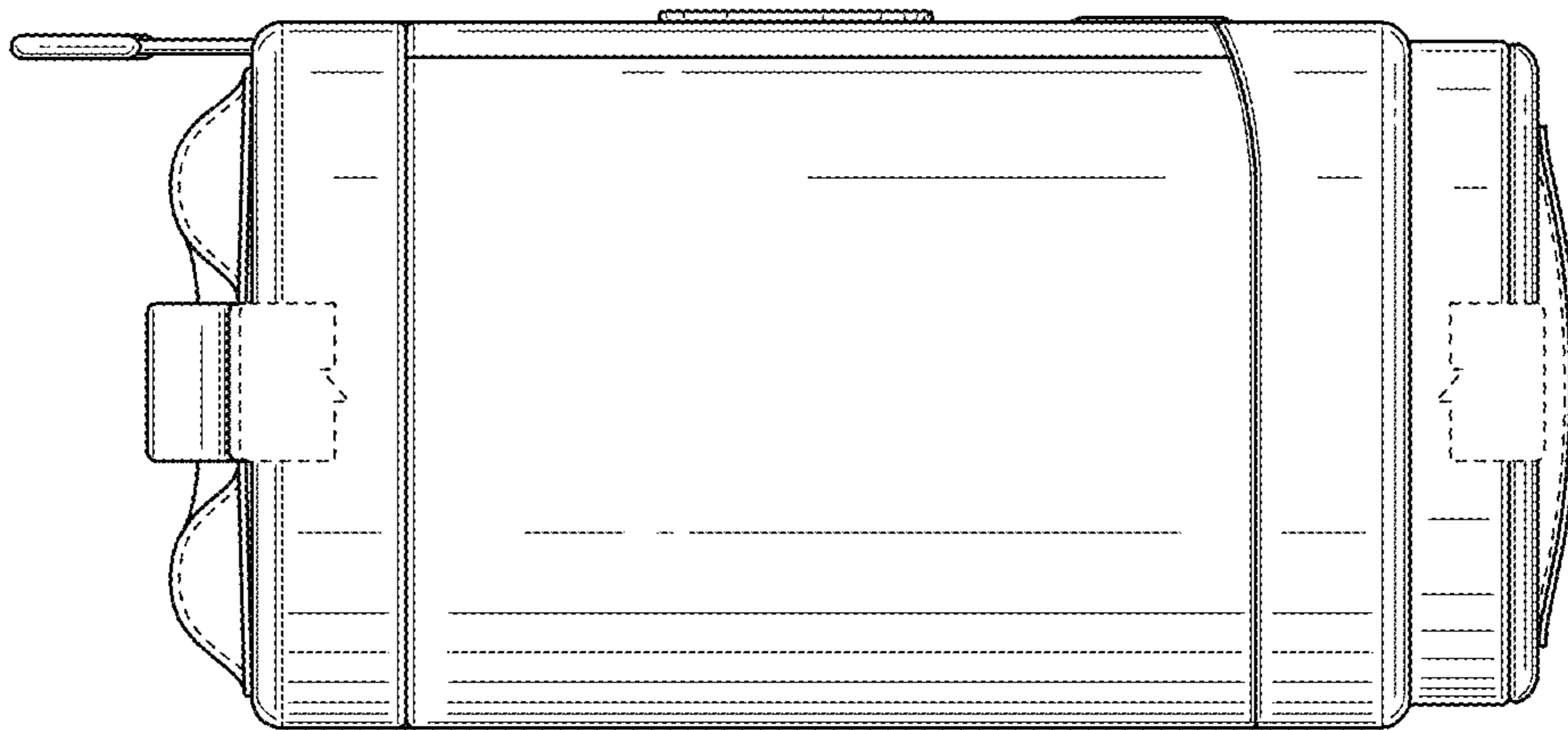

FIG. 6

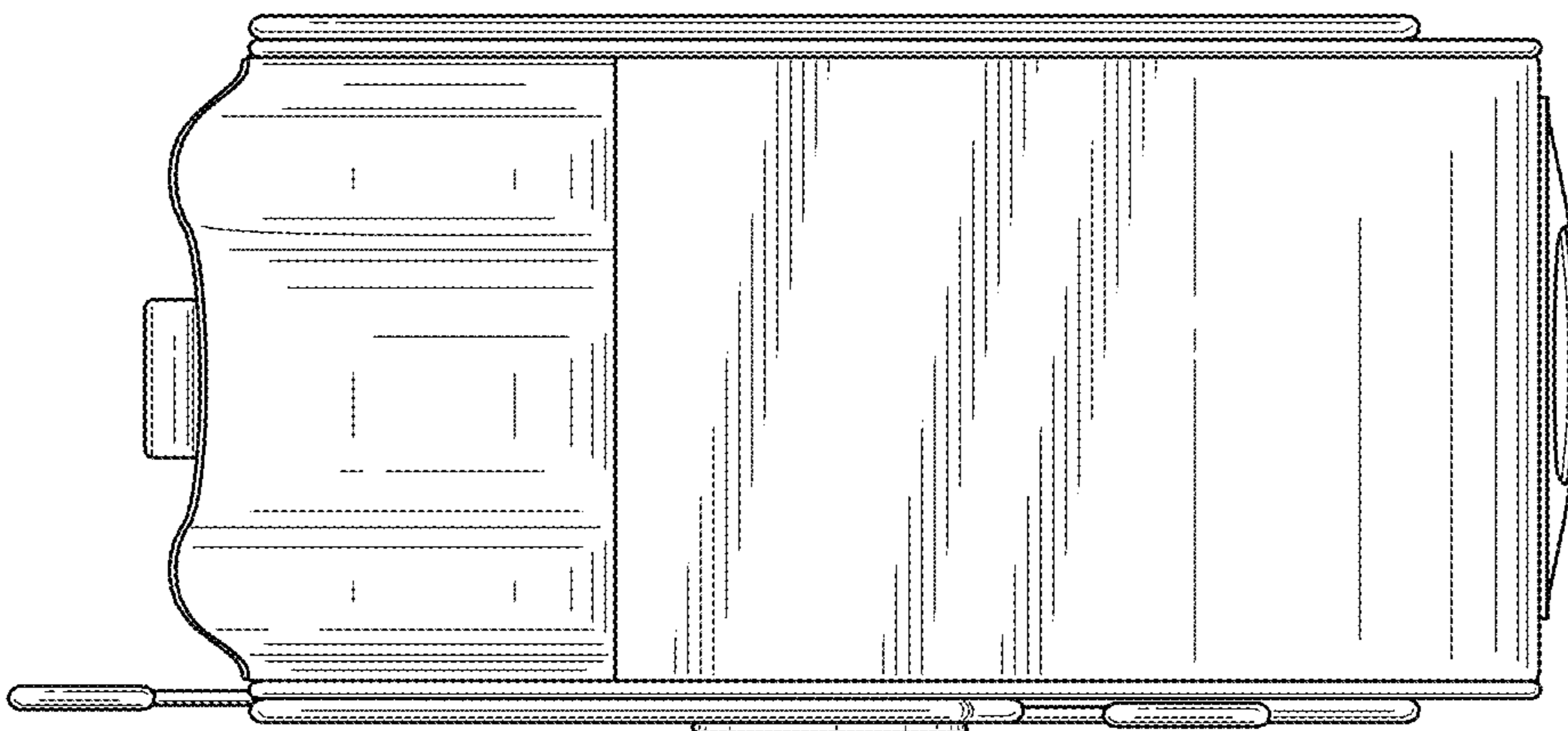

FIG. 7

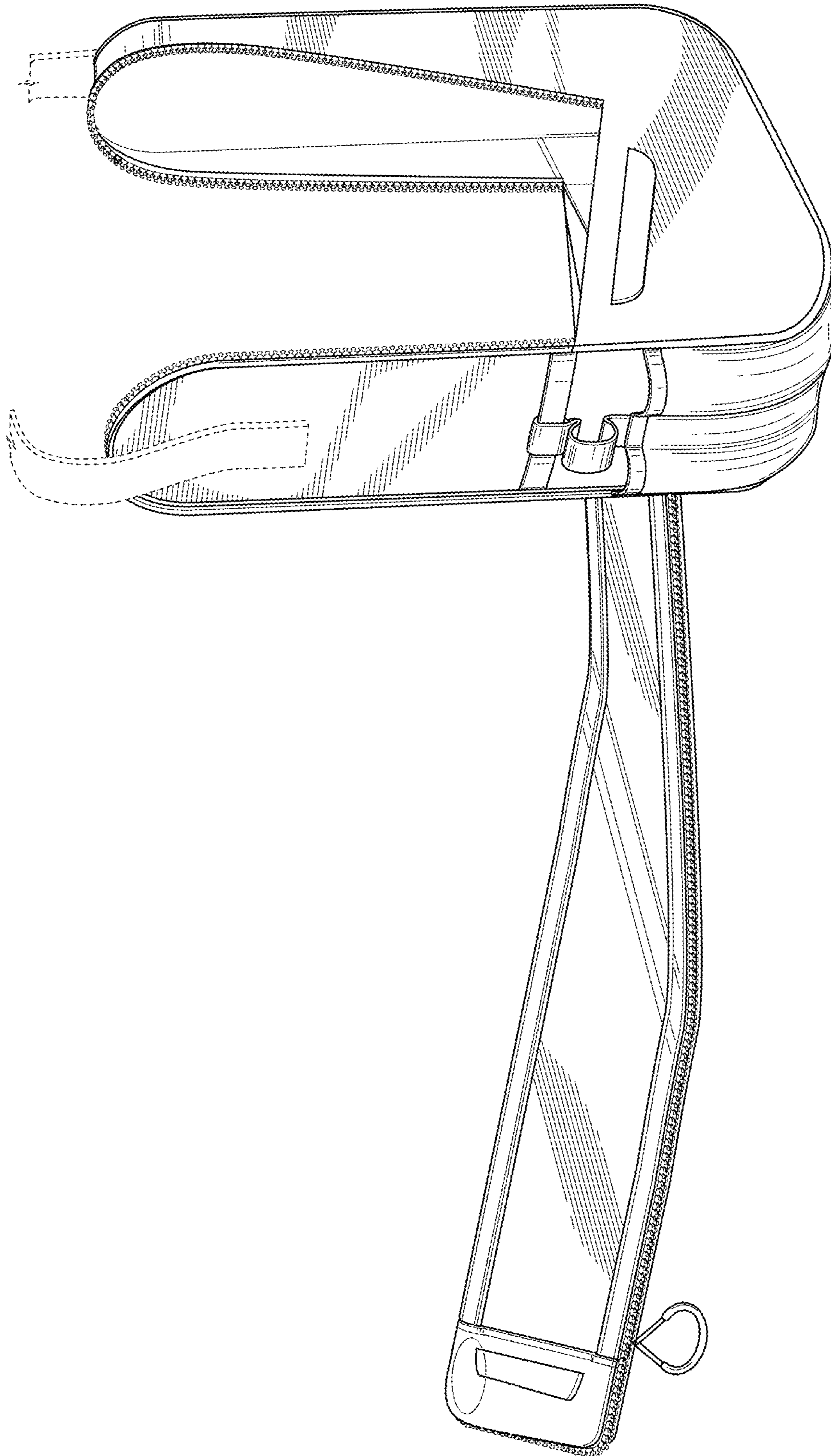

FIG. 8