



US00D831354S

(12) **United States Design Patent**
McBride

(10) **Patent No.:** **US D831,354 S**
(45) **Date of Patent:** **** Oct. 23, 2018**

- (54) **ROLL-UP ITEM ORGANIZER AND TOTE**
- (71) Applicant: **EARLYBIRD BLUE, INC.**, San Diego, CA (US)
- (72) Inventor: **Julie Marie McBride**, San Diego, CA (US)
- (73) Assignee: **EARLYBIRD BLUE, INC.**, San Diego, CA (US)
- (**) Term: **15 Years**
- (21) Appl. No.: **29/607,928**
- (22) Filed: **Jun. 16, 2017**
- (51) **LOC (11) Cl.** **03-01**
- (52) **U.S. Cl.**
USPC **D3/299; D6/315**
- (58) **Field of Classification Search**
USPC D6/315–328, 513, 514; D3/283, 299, D3/303
CPC .. A47G 25/746; A47G 25/36; A47G 25/0685; A47G 25/005; A47G 25/38; A47G 25/0664; A47G 25/90; A47G 29/00; A47G 25/56; A47F 7/08; A47F 5/0006; A47F 7/00; A47F 7/19; A47F 7/24; A47F 5/10; A47F 5/0043; A47B 61/04; A47B 96/027; A47B 61/003; A47B 87/0207; A47B 47/00; A47B 45/00
See application file for complete search history.

- D466,686 S * 12/2002 Brookhouse; Geoff Joseph D3/206
 - 6,763,943 B1 * 7/2004 Domyan D05C 1/065 206/388
 - D578,802 S * 10/2008 Russell; Brian D6/682.4
- (Continued)

OTHER PUBLICATIONS

3onfirmation of an Application for a Community Design issued on 14 Apr. 2014 in Rcd Application No. 002446898 (10 pp.).

Primary Examiner — Lauren R Calve
(74) *Attorney, Agent, or Firm* — Northstar Law Group; Thomas Bassolino

(57) **CLAIM**

The ornamental design for a roll-up item organizer and tote, as shown and described.

DESCRIPTION

FIG. 1 is a front perspective view of a roll-up item organizer and tote;
 FIG. 2 is a front view thereof;
 FIG. 3 is a rear view thereof;
 FIG. 4 is a left side view thereof;
 FIG. 5 is a right side view thereof;
 FIG. 6 is a top view thereof;
 FIG. 7 is a bottom view thereof;
 FIG. 8 is a front perspective view of the roll-up item organizer and tote shown in an alternate configuration and in environmental use;
 FIG. 9 is a front view of the roll-up item organizer and tote shown with an unclaimed optional pattern thereon;
 FIG. 10 is a rear view of the roll-up item organizer and tote shown with an unclaimed optional pattern and logo thereon; and,
 FIG. 11 is a top perspective view of the roll-up item organizer and tote shown in a rolled-up configuration.
 The broken lines showing portions of the design are for illustrative purposes only and form no part of the claimed design.

1 Claim, 8 Drawing Sheets

(56) **References Cited**

U.S. PATENT DOCUMENTS

- 1,526,122 A * 2/1925 Otto Dau A45C 11/26 206/479
- 4,735,246 A * 4/1988 Niehaus A45C 7/0095 206/479
- D297,283 S * 8/1988 Gray; Evelyn A D3/299
- 4,821,883 A * 4/1989 Miller A45C 7/0095 206/225
- D321,789 S * 11/1991 Martorella; Ellen D3/293

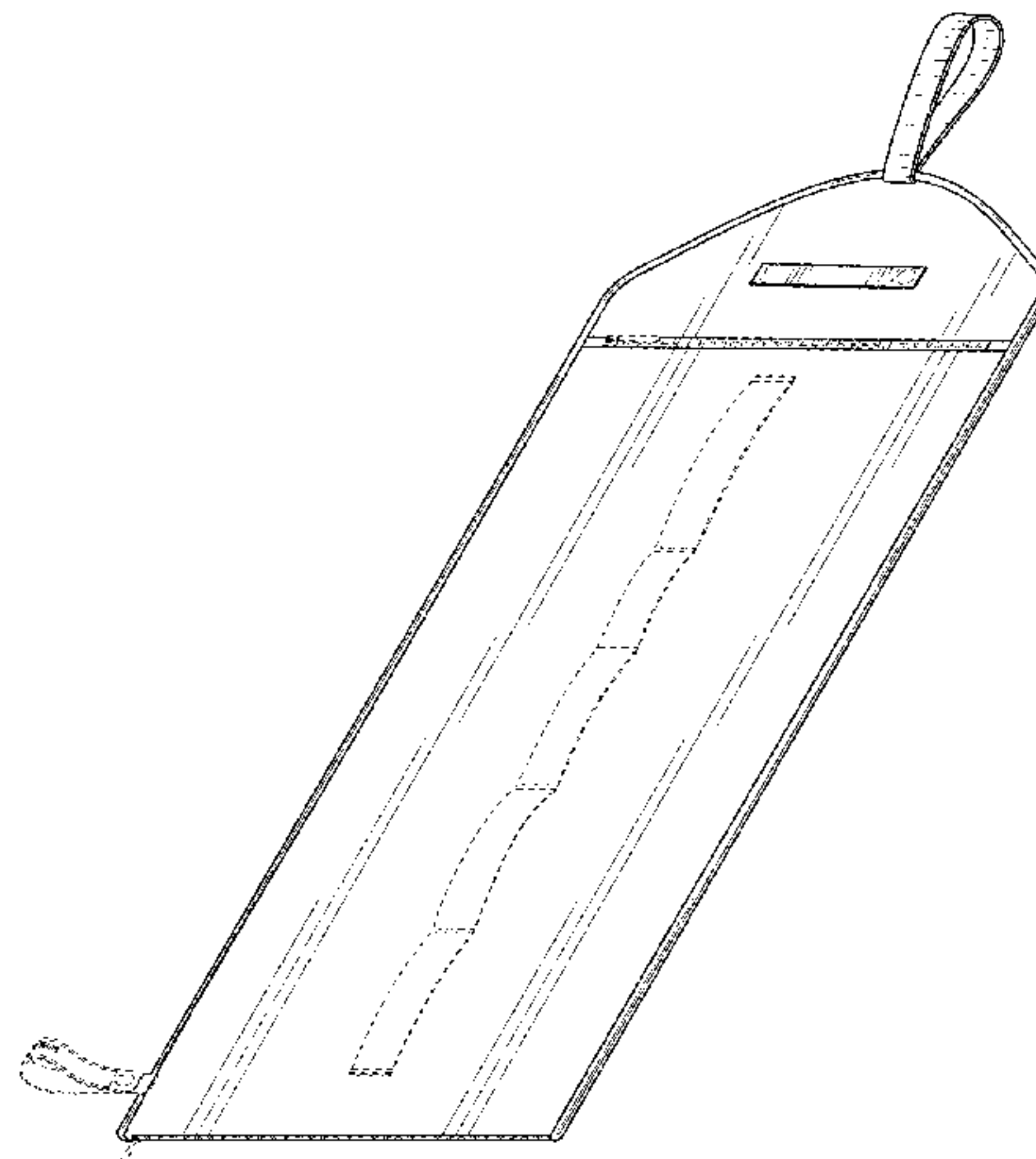

(56)

References Cited

U.S. PATENT DOCUMENTS

D595,918 S * 7/2009 Walter;Or Michel, IV ... D34/27
D603,165 S * 11/2009 Losiewicz; Henry Paul
D3/299
7,806,124 B2 * 10/2010 MacKinder A45C 11/26
132/222
D627,163 S * 11/2010 Kittrell; Walter D3/283
D627,167 S * 11/2010 Kittrell; Walter D3/299
D631,244 S * 1/2011 Ferrence; Christy D3/205
D646,485 S * 10/2011 Mason; Ann D3/284
8,479,918 B2 * 7/2013 Howard
D719,748 S * 12/2014 Higbie; Carol D6/328
D720,537 S * 1/2015 Taller; Benjamin D3/285
D795,581 S * 8/2017 Cruz; Stephen D3/303
2004/0222125 A1 * 11/2004 Meing A45C 11/26
206/581
2009/0127045 A1 * 5/2009 Williams A45C 7/0059
190/107
2012/0111741 A1 * 5/2012 Walters A45C 11/26
206/6.1
2013/0256159 A1 * 10/2013 Walsh A45C 11/16
206/6.1

* cited by examiner

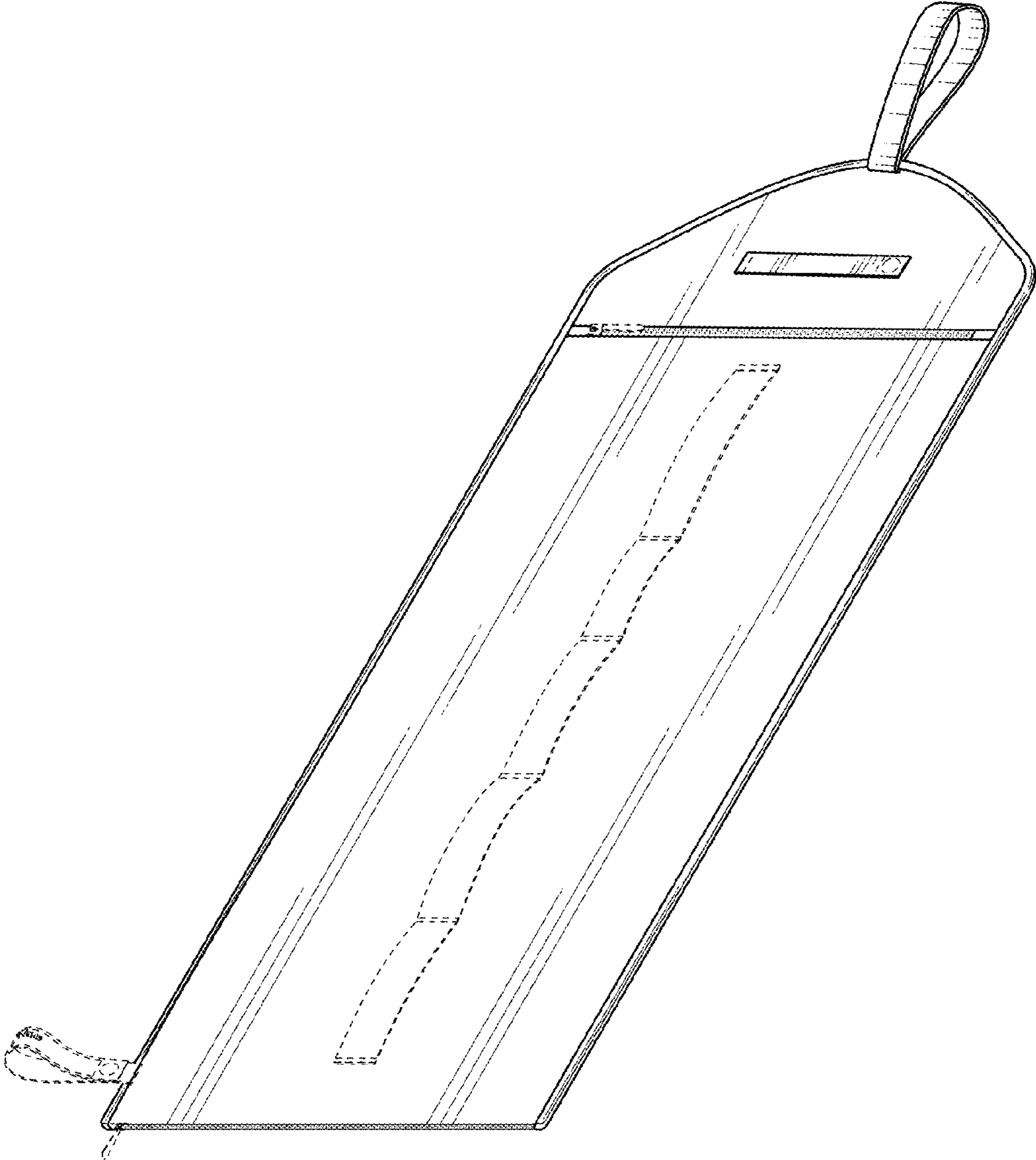

FIG. 1

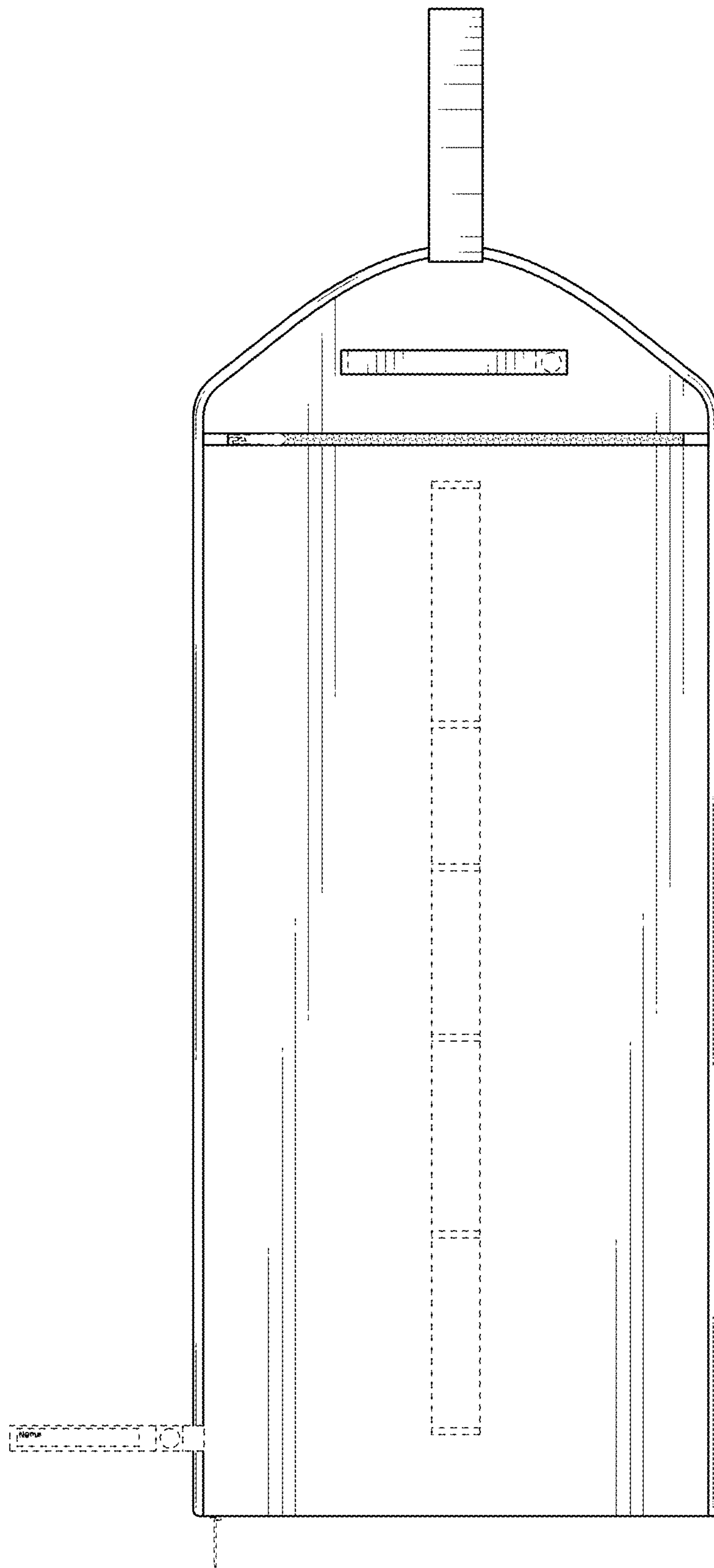

FIG. 2



FIG. 3

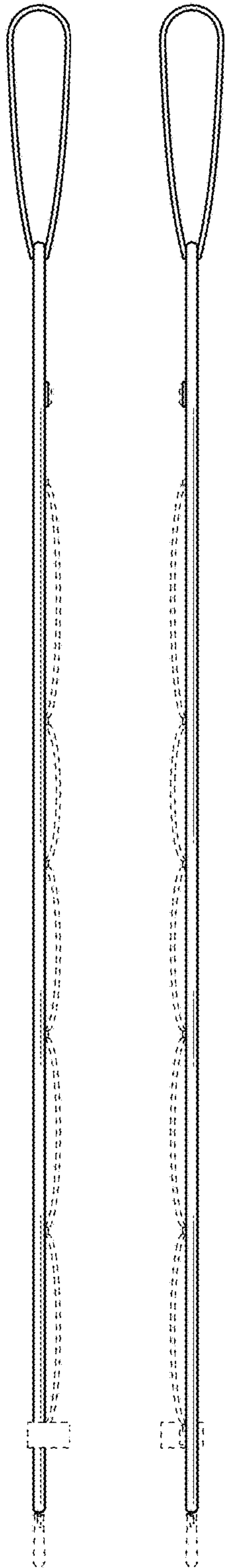

FIG. 4

FIG. 5

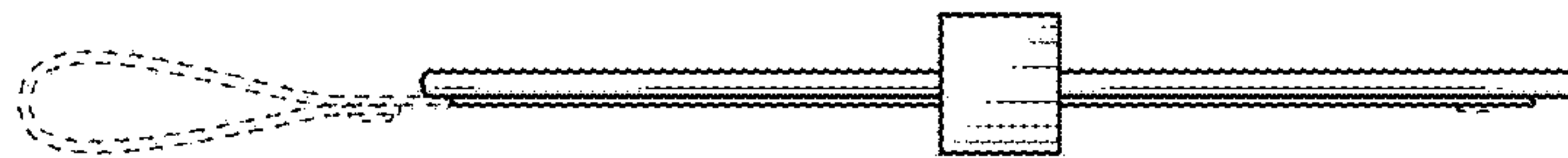

FIG. 6



FIG. 7

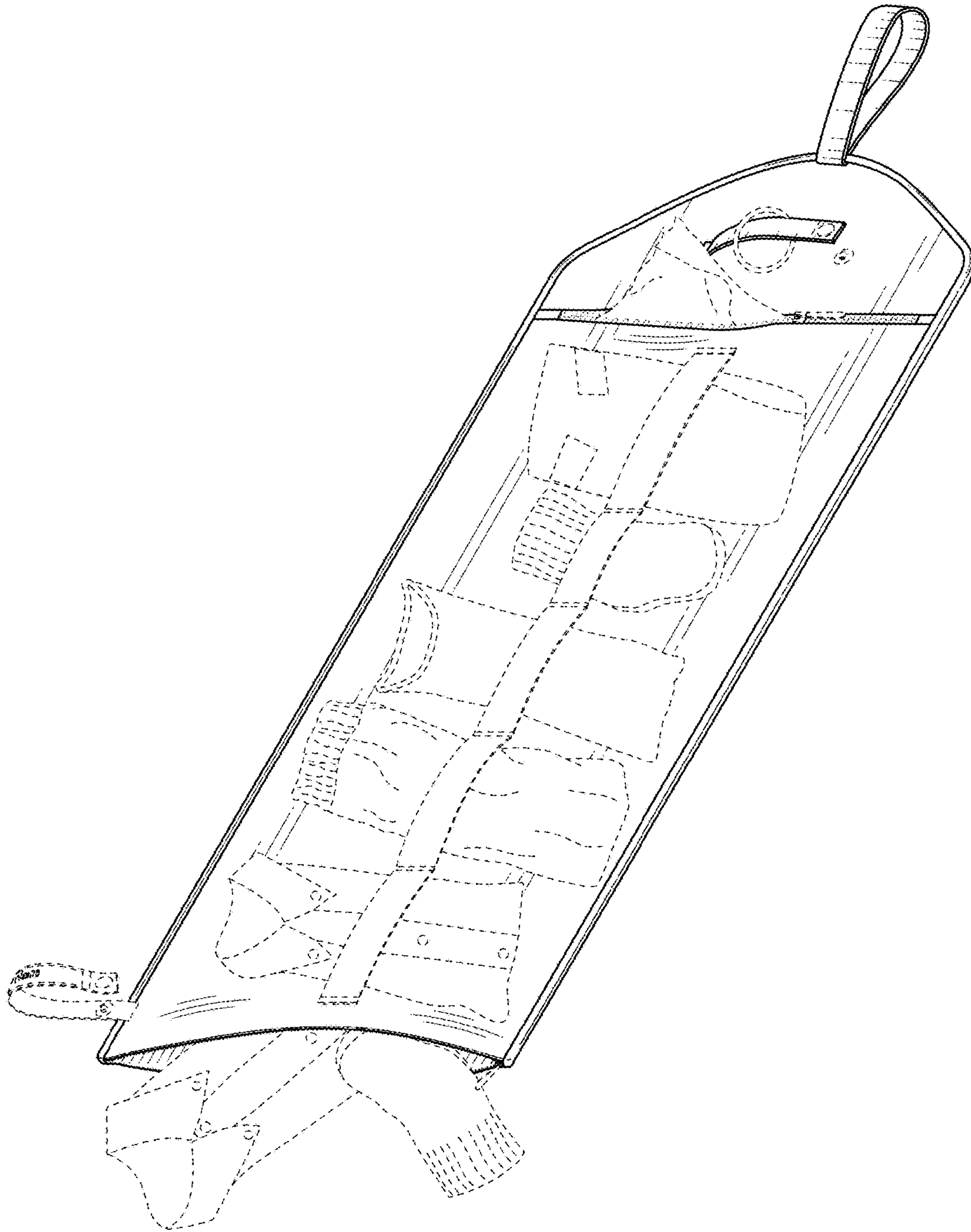

FIG. 8

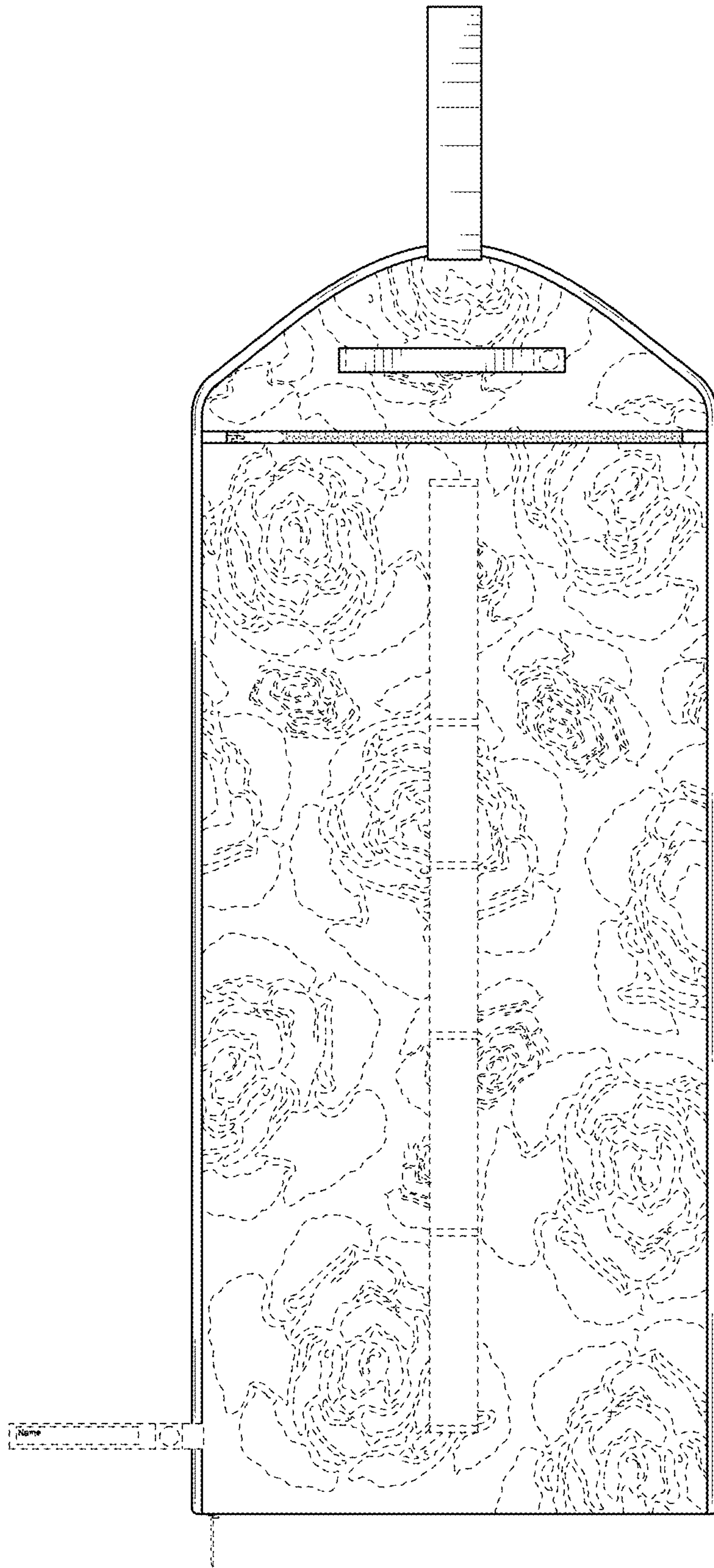

FIG. 9

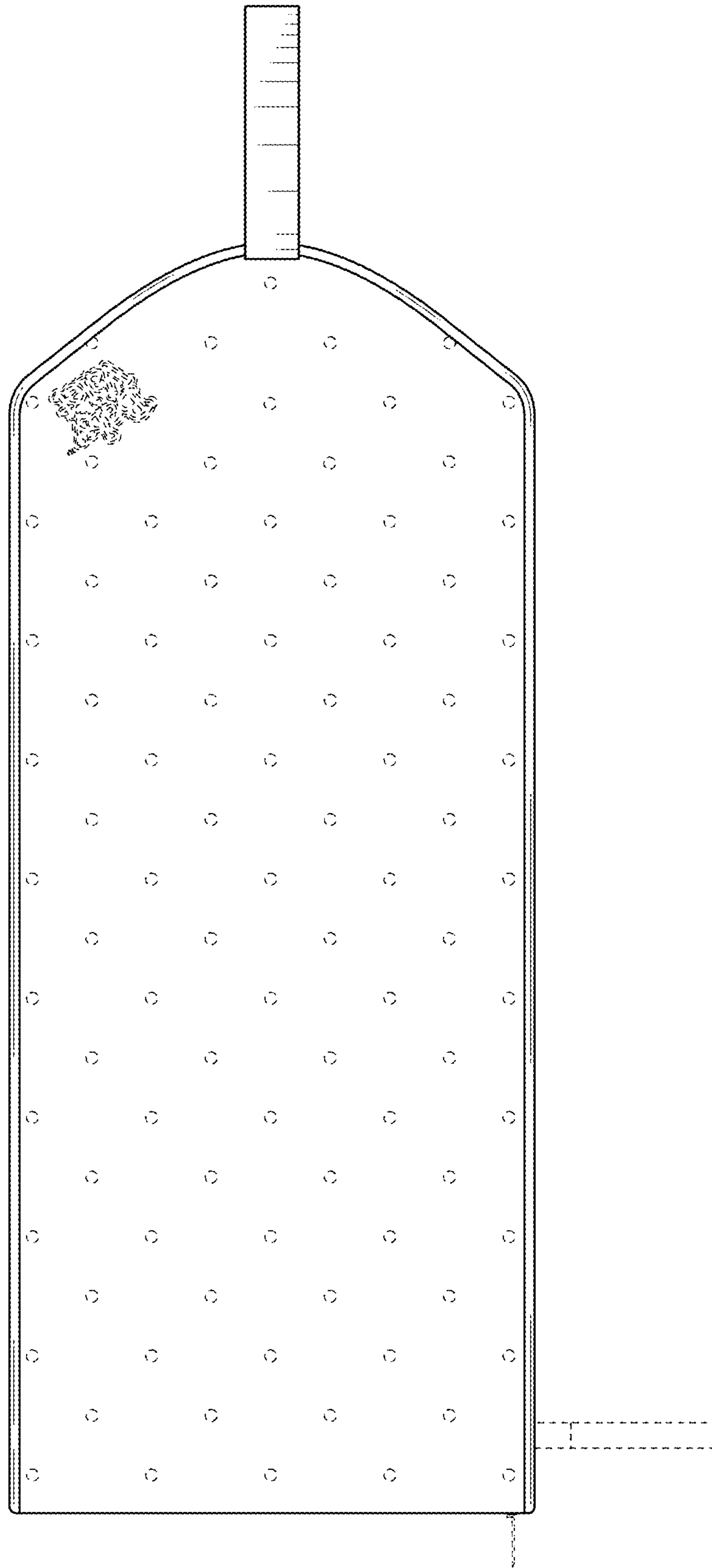

FIG. 10

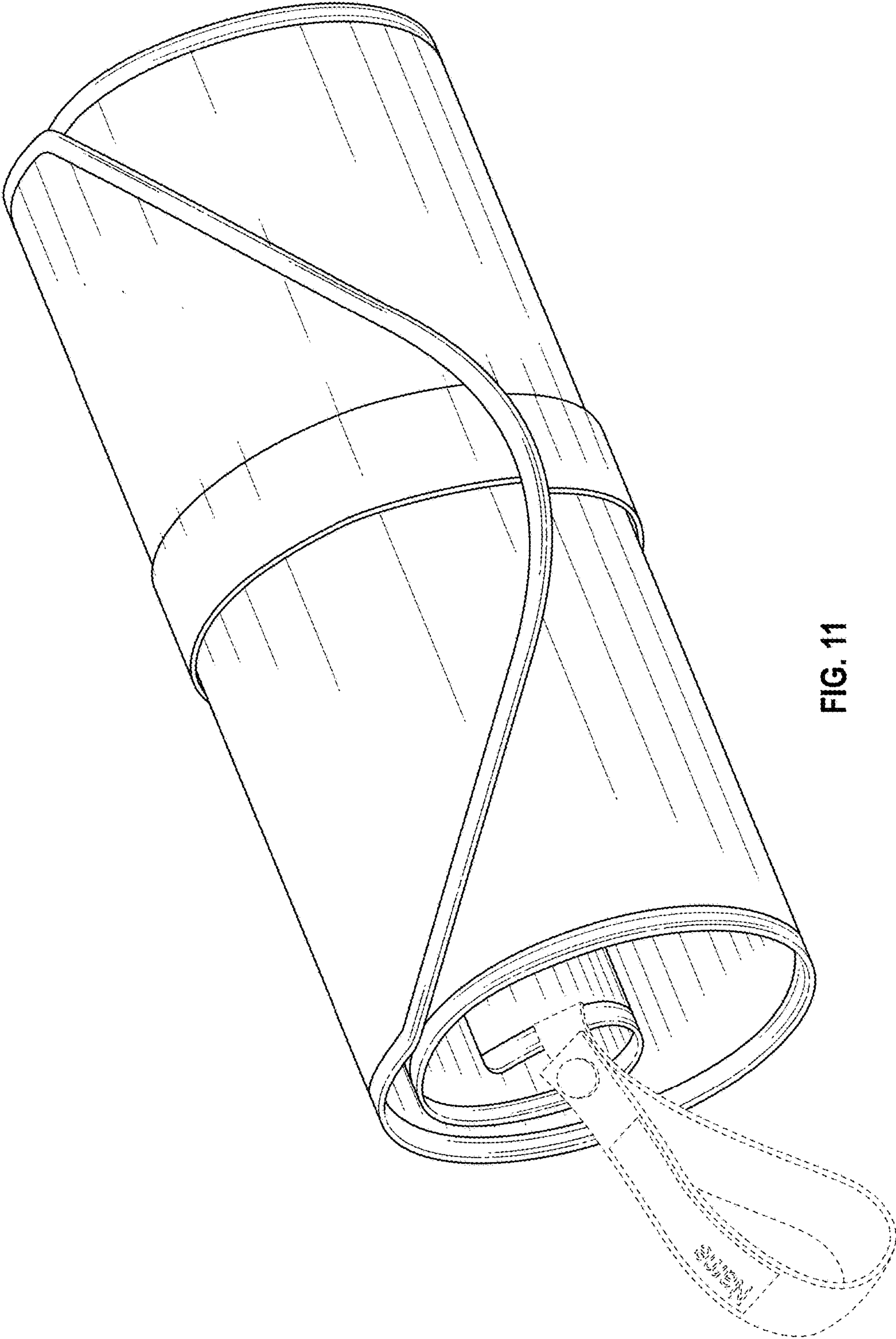

FIG. 11