



US00D831339S

(12) **United States Design Patent**
Villebro

(10) **Patent No.:** **US D831,339 S**
(45) **Date of Patent:** **** Oct. 23, 2018**

(54) **MESH BAG**

(71) Applicant: **FREZZ SOLUTIONS IVS**, Svendborg (DK)

(72) Inventor: **Nicolai Villebro**, Svendborg (DK)

(73) Assignee: **FREZZ SOLUTIONS IVS**, Svendborg (DK)

(**) Term: **15 Years**

(21) Appl. No.: **29/579,726**

(22) Filed: **Oct. 3, 2016**

(30) **Foreign Application Priority Data**

Apr. 4, 2016 (EM) 003054394

(51) **LOC (11) Cl.** **03-01**

(52) **U.S. Cl.**
USPC **D3/226**

(58) **Field of Classification Search**
USPC D3/300-303; D9/709; 206/484, 523;
383/37, 63, 77, 42, 65, 10, 117
(Continued)

(56) **References Cited**

U.S. PATENT DOCUMENTS

684,181 A * 10/1901 Briery 383/107
2,344,369 A * 3/1944 Salfisberg B65D 31/04
206/527

(Continued)

Primary Examiner — Catherine R Oliver-Garcia
(74) *Attorney, Agent, or Firm* — McDermott Will & Emery LLP

(57) **CLAIM**

I claim the ornamental design for a mesh bag, as shown and described.

DESCRIPTION

FIG. 1 is an elevated perspective view of a mesh bag according to a new design.

FIG. 2 is a front view of the mesh bag shown in FIG. 1.
FIG. 3 is a rear view of the mesh bag shown in FIG. 1.
FIG. 4 is a right side view of the mesh bag shown in FIG. 1.
FIG. 5 is a left side view of the mesh bag shown in FIG. 1.
FIG. 6 is a top view of the mesh bag shown in FIG. 1.
FIG. 7 is a bottom view of the mesh bag shown in FIG. 1.
FIG. 8 is an elevated perspective view of a second embodiment of a mesh bag according to a new design.
FIG. 9 is a front view of the mesh bag shown in FIG. 8.
FIG. 10 is a rear view of the mesh bag shown in FIG. 8.
FIG. 11 is a right side view of the mesh bag shown in FIG. 8.
FIG. 12 is a left side view of the mesh bag shown in FIG. 8.
FIG. 13 is a top view of the mesh bag shown in FIG. 8.
FIG. 14 is a bottom view of the mesh bag shown in FIG. 8.
FIG. 15 is an elevated perspective view of a third embodiment of a mesh bag according to a new design.
FIG. 16 is a front view of the mesh bag shown in FIG. 15.
FIG. 17 is a rear view of the mesh bag shown in FIG. 15.
FIG. 18 is a right side view of the mesh bag shown in FIG. 15.
FIG. 19 is a left side view of the mesh bag shown in FIG. 15.
FIG. 20 is a top view of the mesh bag shown in FIG. 15.
FIG. 21 is a bottom view of the mesh bag shown in FIG. 15.
FIG. 22 is an elevated perspective view of a fourth embodiment of a mesh bag according to a new design.
FIG. 23 is a front view of the mesh bag shown in FIG. 22.
FIG. 24 is a rear view of the mesh bag shown in FIG. 22.
FIG. 25 is a right side view of the mesh bag shown in FIG. 22.
FIG. 26 is a left side view of the mesh bag shown in FIG. 22.
FIG. 27 is a top view of the mesh bag shown in FIG. 22.
FIG. 28 is a bottom view of the mesh bag shown in FIG. 22.
FIG. 29 is an elevated perspective view of a fifth embodiment of a mesh bag according to a new design.
FIG. 30 is a front view of the mesh bag shown in FIG. 29.
FIG. 31 is a rear view of the mesh bag shown in FIG. 29.
FIG. 32 is a right side view of the mesh bag shown in FIG. 29.

(Continued)

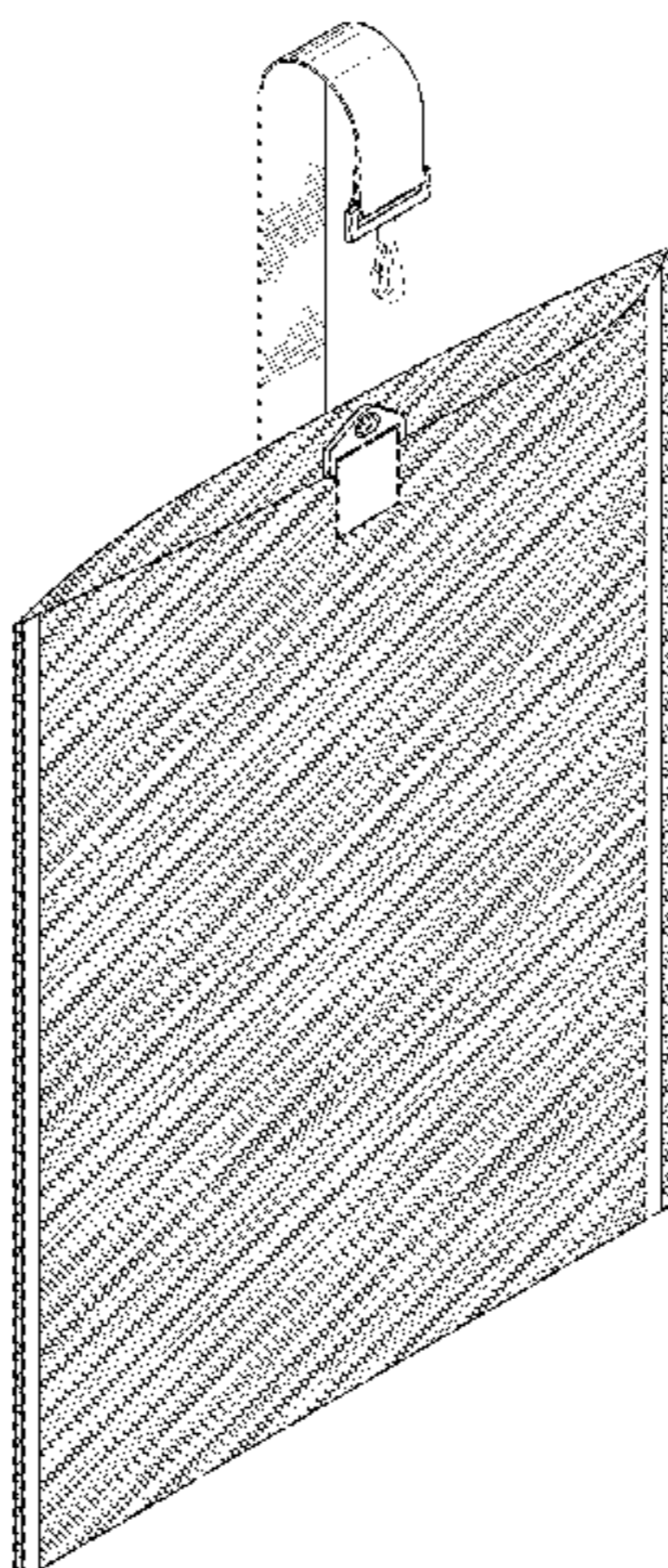

FIG. 33 is a left side view of the mesh bag shown in FIG. 29.
 FIG. 34 is a top view of the mesh bag shown in FIG. 29.
 FIG. 35 is a bottom view of the mesh bag shown in FIG. 29.
 FIG. 36 is an elevated perspective view of a sixth embodiment of a mesh bag according to a new design.
 FIG. 37 is a front view of the mesh bag shown in FIG. 36.
 FIG. 38 is a rear view of the mesh bag shown in FIG. 36.
 FIG. 39 is a right side view of the mesh bag shown in FIG. 36.
 FIG. 40 is a left side view of the mesh bag shown in FIG. 36.
 FIG. 41 is a top view of the mesh bag shown in FIG. 36.
 FIG. 42 is a bottom view of the mesh bag shown in FIG. 36.
 FIG. 43 is an elevated perspective view of a seventh embodiment of a mesh bag according to a new design.
 FIG. 44 is a front view of the mesh bag shown in FIG. 43.
 FIG. 45 is a rear view of the mesh bag shown in FIG. 43.
 FIG. 46 is a right side view of the mesh bag shown in FIG. 43.
 FIG. 47 is a left side view of the mesh bag shown in FIG. 43.
 FIG. 48 is a top view of the mesh bag shown in FIG. 43; and,
 FIG. 49 is a bottom view of the mesh bag shown in FIG. 43.
 The broken lines represent environmental structure that are for illustrative purposes only and form no part of the claimed design.

1 Claim, 34 Drawing Sheets

(58) **Field of Classification Search**
 CPC ... A45C 3/00; A47K 3/28; A47K 7/03; B65D 3/06; B65D 33/14; B65D 33/16
 See application file for complete search history.

(56)

References Cited

U.S. PATENT DOCUMENTS

| | | | | |
|-----------|------|---------|-------------------|----------------------------|
| 2,580,712 | A * | 1/1952 | Weisberg | B65D 33/02 383/106 |
| 2,781,162 | A * | 2/1957 | Soffa | B65D 33/243 383/10 |
| 3,123,279 | A * | 3/1964 | Day | B65D 31/00 383/102 |
| 3,217,971 | A * | 11/1965 | Shvetz | B65D 33/165 383/37 |
| 3,231,901 | A * | 2/1966 | Kennedy | A61F 5/4408 128/DIG. 24 |
| 3,257,915 | A * | 6/1966 | Cartier | B31B 70/00 383/117 |
| 4,087,002 | A * | 5/1978 | Bambara | B29C 65/18 206/523 |
| 4,186,786 | A * | 2/1980 | Kirkpatrick | B65D 33/255 383/63 |
| 4,228,834 | A * | 10/1980 | Desnick | A47K 7/03 383/117 |
| 4,410,441 | A * | 10/1983 | Davies | B65D 81/3261 383/1 |
| 5,092,682 | A * | 3/1992 | Fenick | A47K 3/281 383/102 |
| D344,407 | S * | 2/1994 | Derrickson | D3/245 |
| 6,371,642 | B1 * | 4/2002 | Nelson | A47L 15/505 150/900 |
| D464,192 | S * | 10/2002 | Fairbairn | D3/215 |
| 6,575,627 | B2 * | 6/2003 | Huseman | B65D 31/12 383/37 |
| 6,874,938 | B2 * | 4/2005 | Price | A23L 3/01 383/104 |
| D522,750 | S * | 6/2006 | Girod | D3/303 |
| D537,248 | S * | 2/2007 | Schlegel | D3/299 |
| D549,448 | S * | 8/2007 | Fernandez | D3/215 |
| D550,960 | S * | 9/2007 | Schlegel | D12/400 |
| 7,665,896 | B1 * | 2/2010 | Higgs | B32B 3/28 206/524.8 |
| D658,871 | S * | 5/2012 | Voit | D3/226 |
| D687,628 | S * | 8/2013 | Burns | D3/226 |
| D804,179 | S * | 12/2017 | Kolstad | D3/303 |

* cited by examiner

FIG. 1

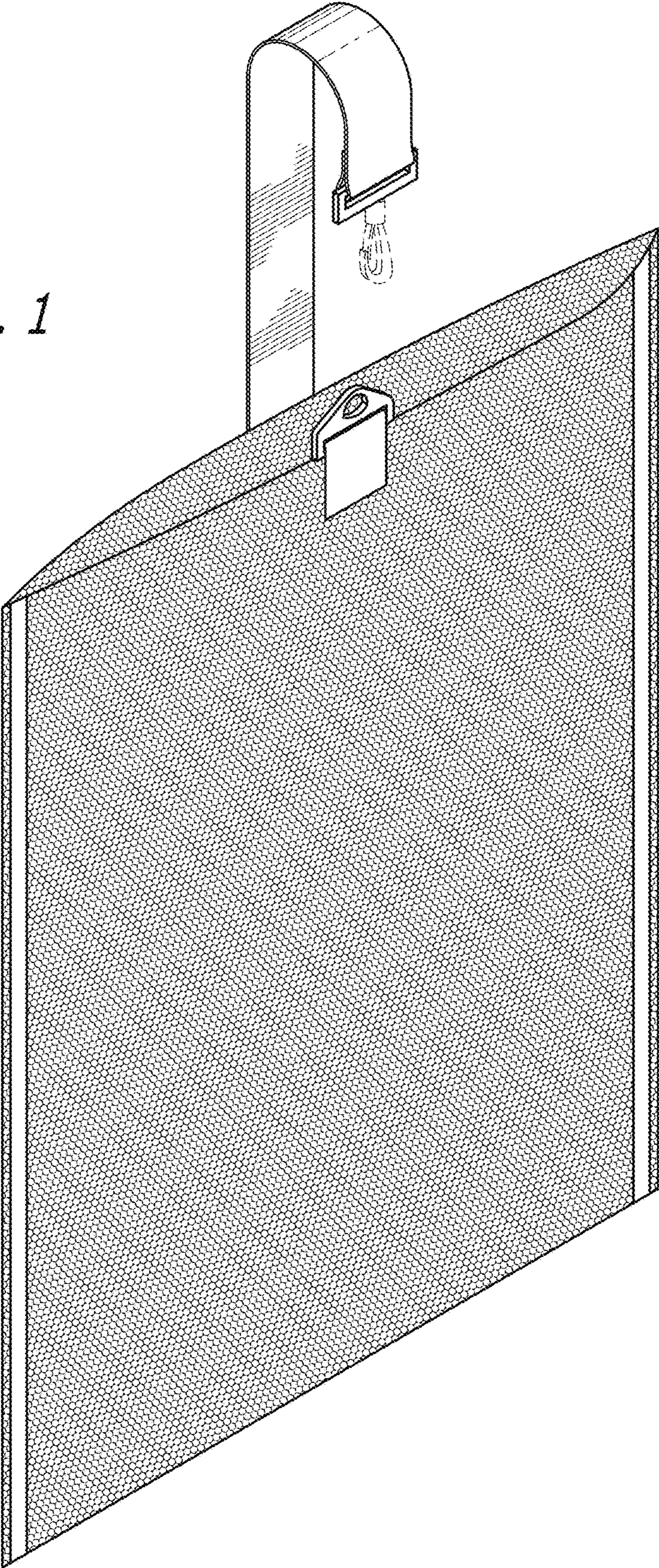

FIG. 2

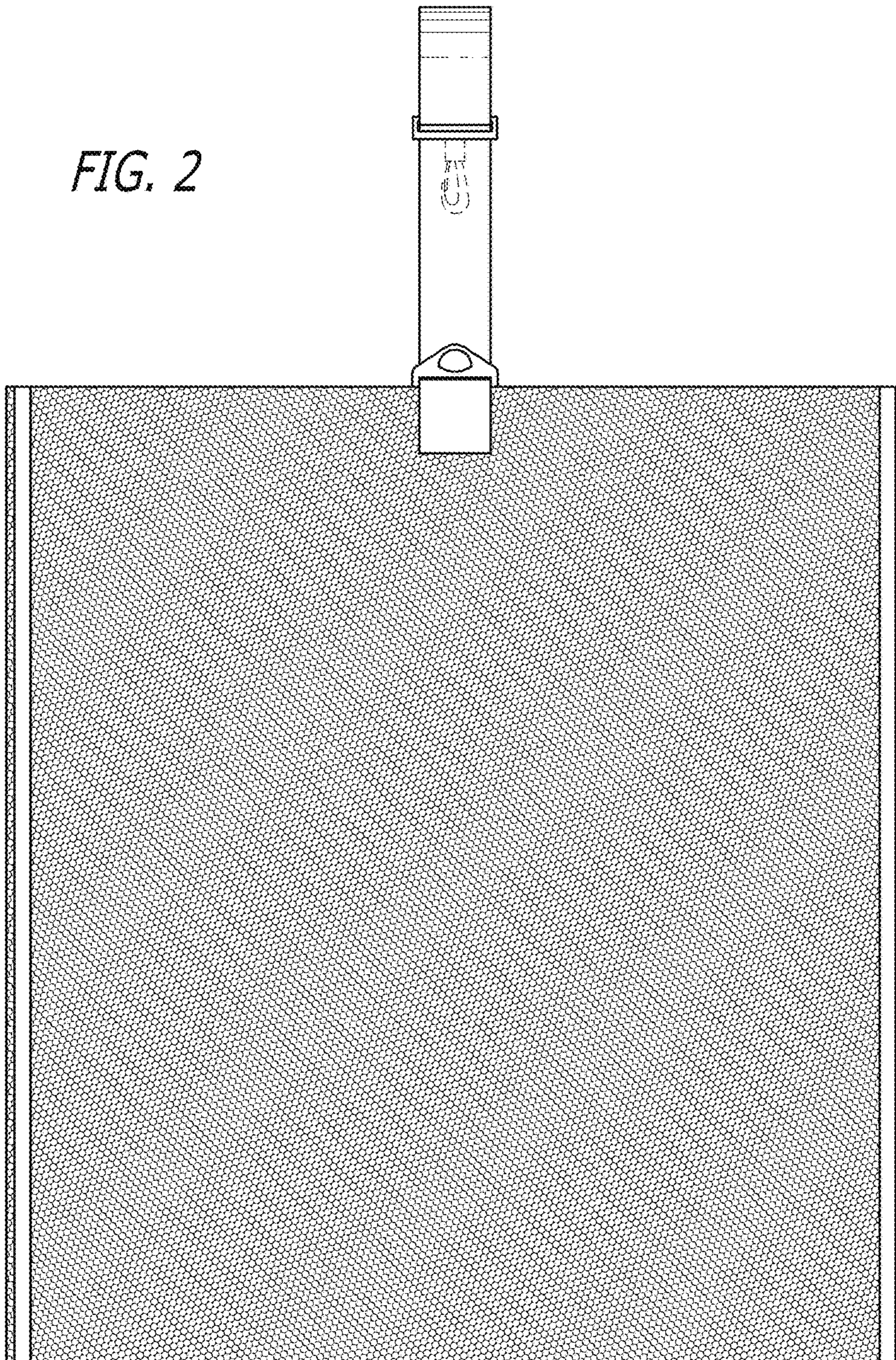
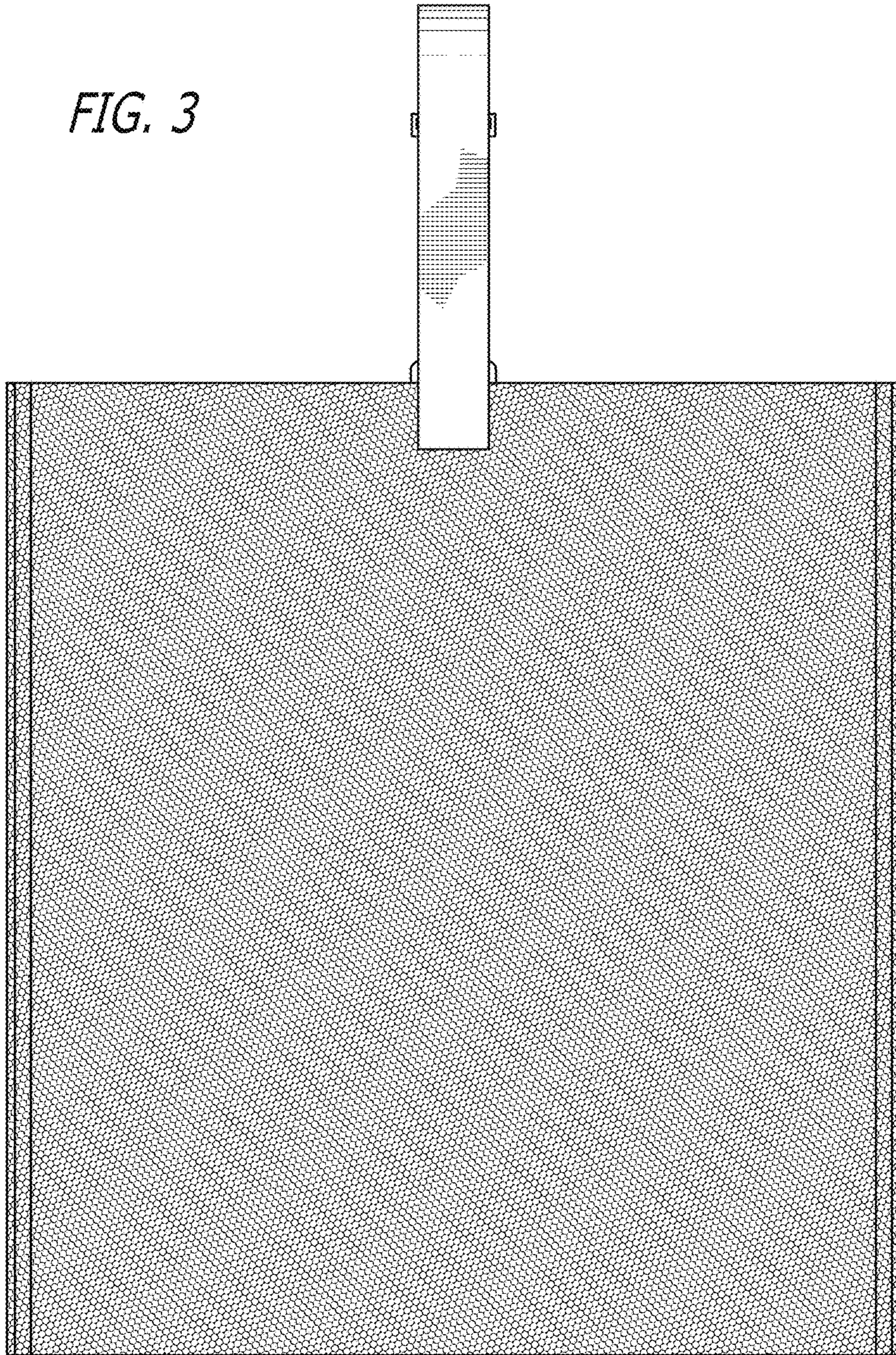

FIG. 3



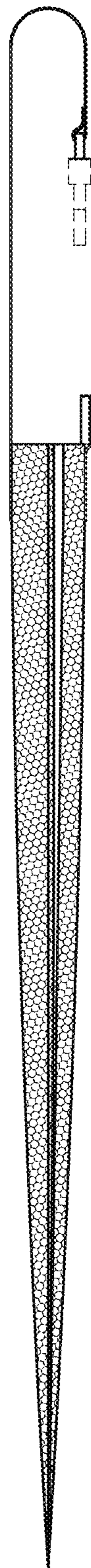

FIG. 4

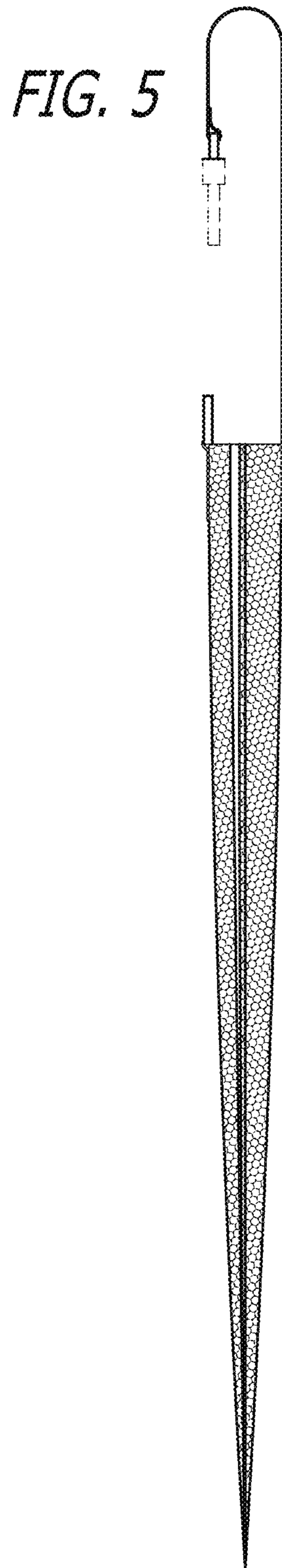

FIG. 5

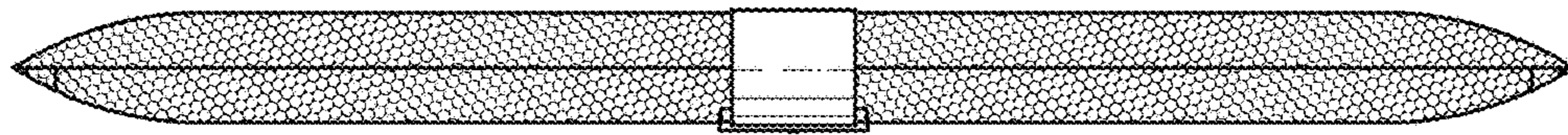

FIG. 6

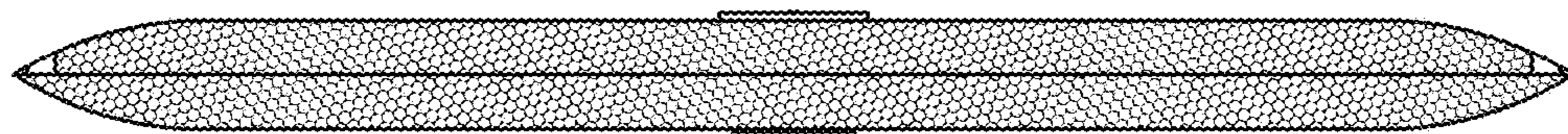

FIG. 7

FIG. 8

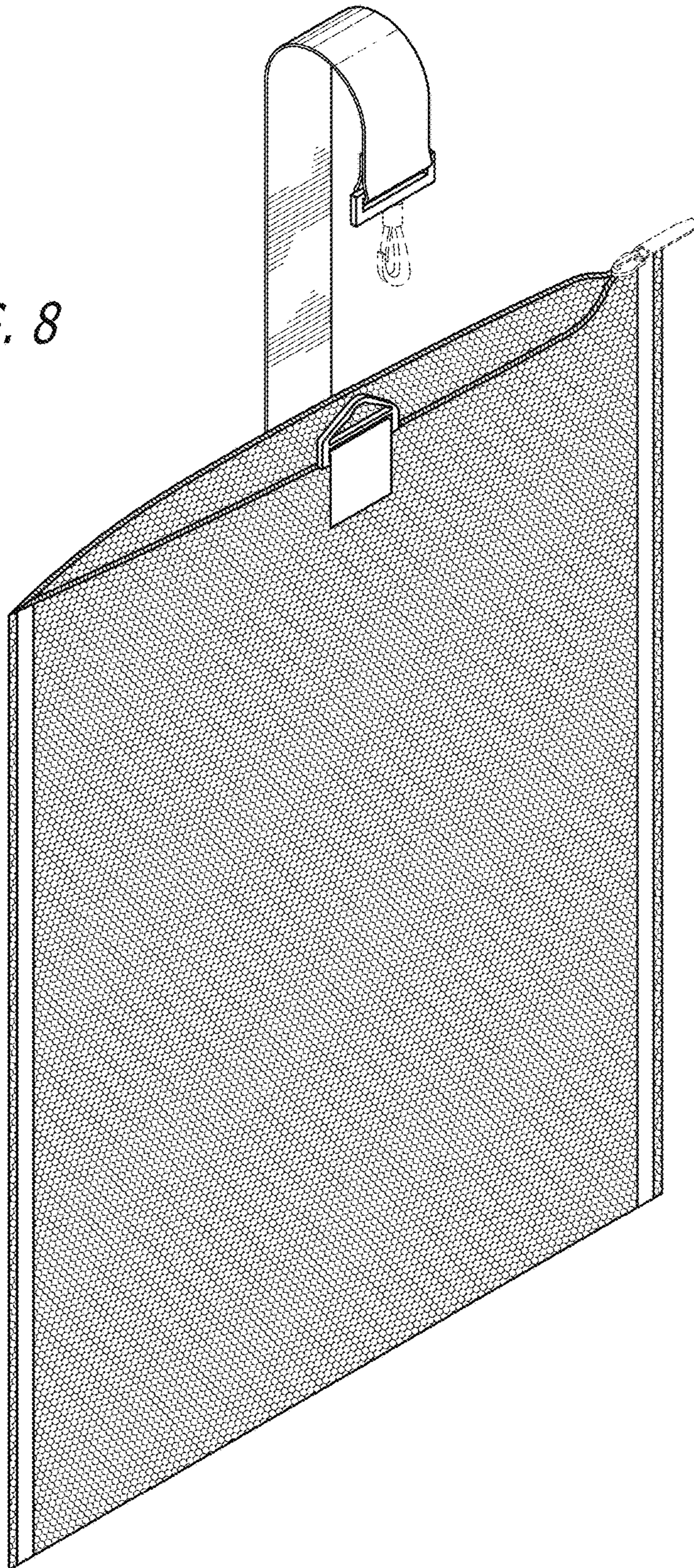

FIG. 9

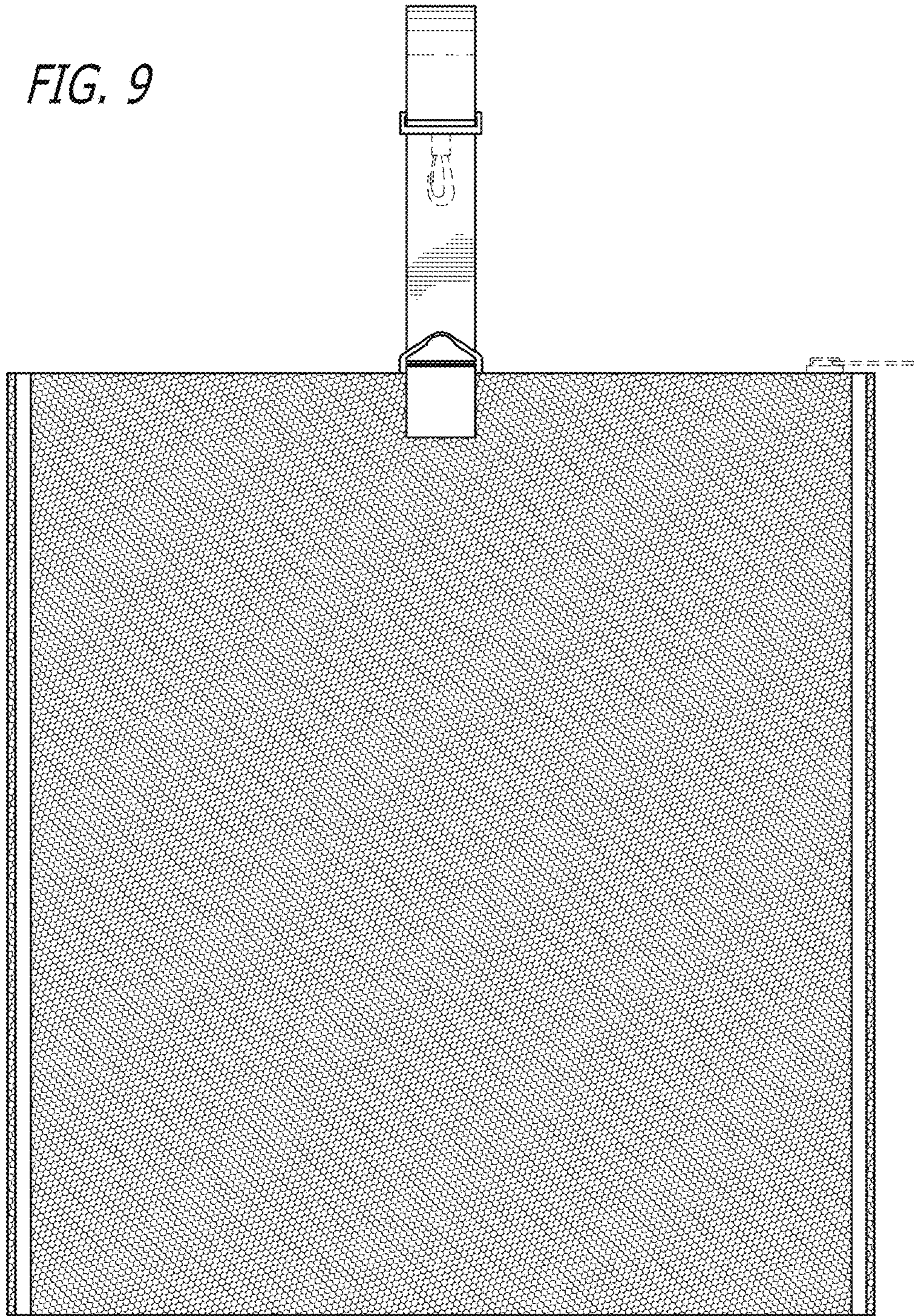
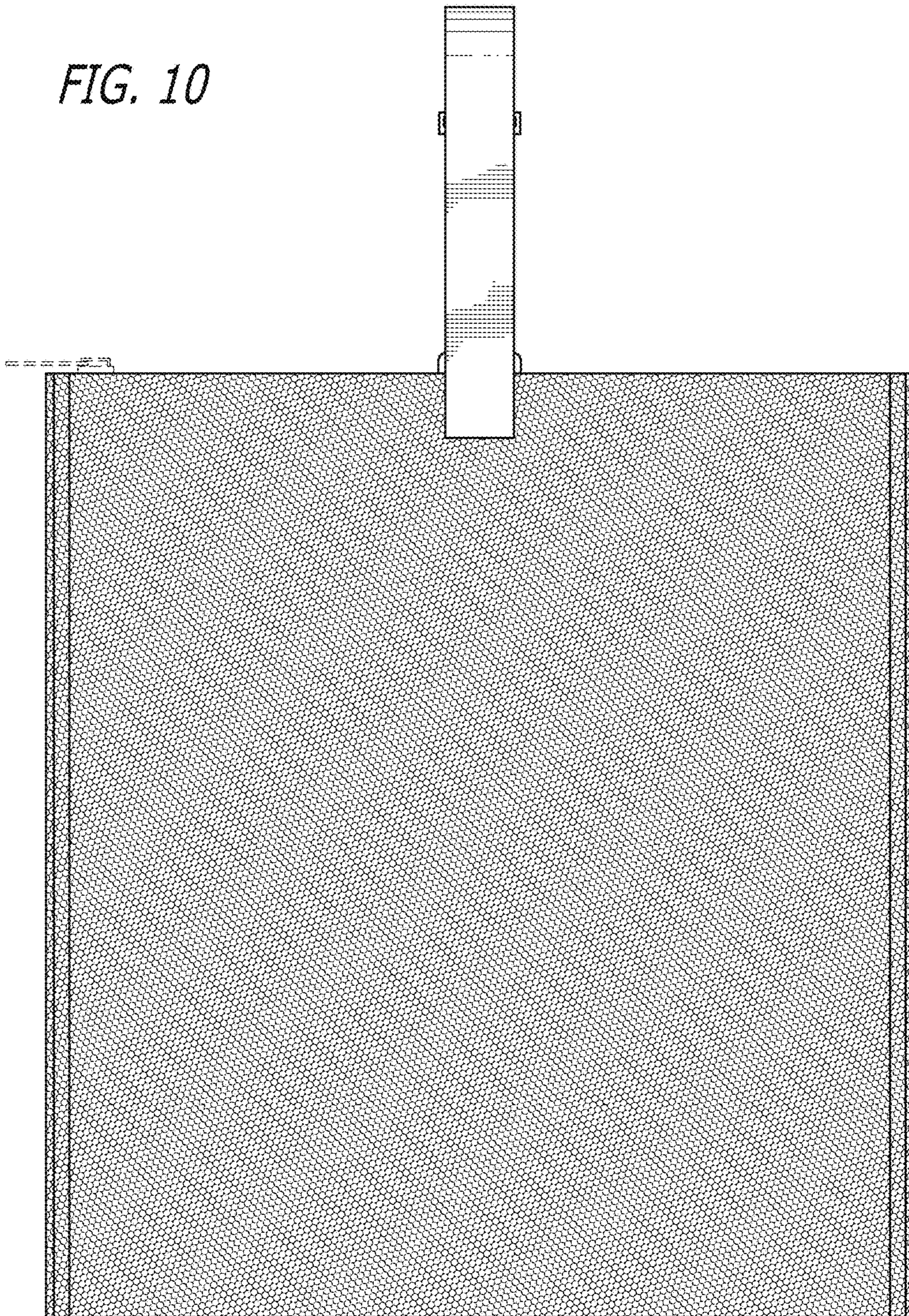

FIG. 10



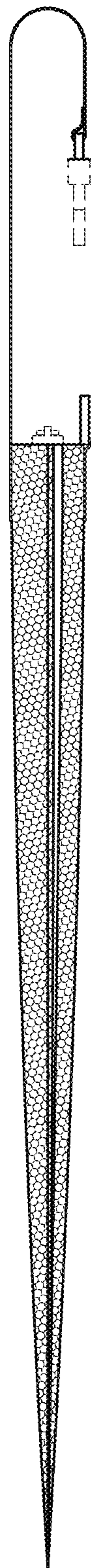
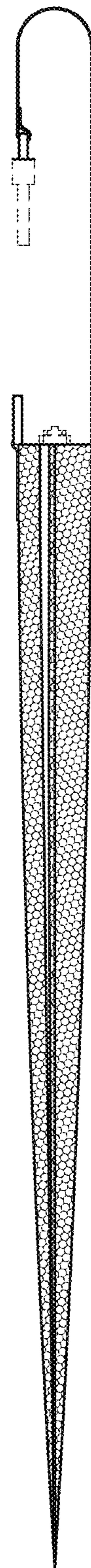

FIG. 11

FIG. 12



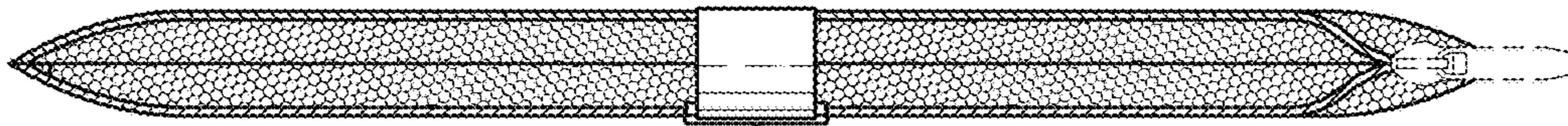

FIG. 13

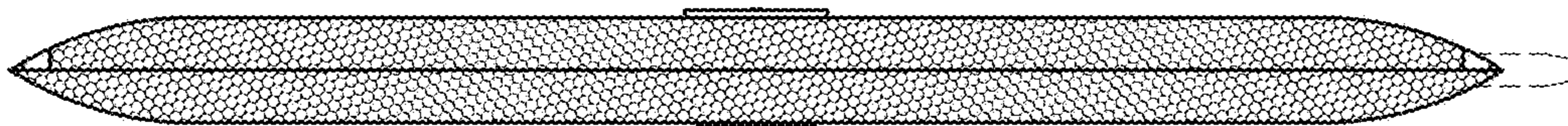

FIG. 14

FIG. 15

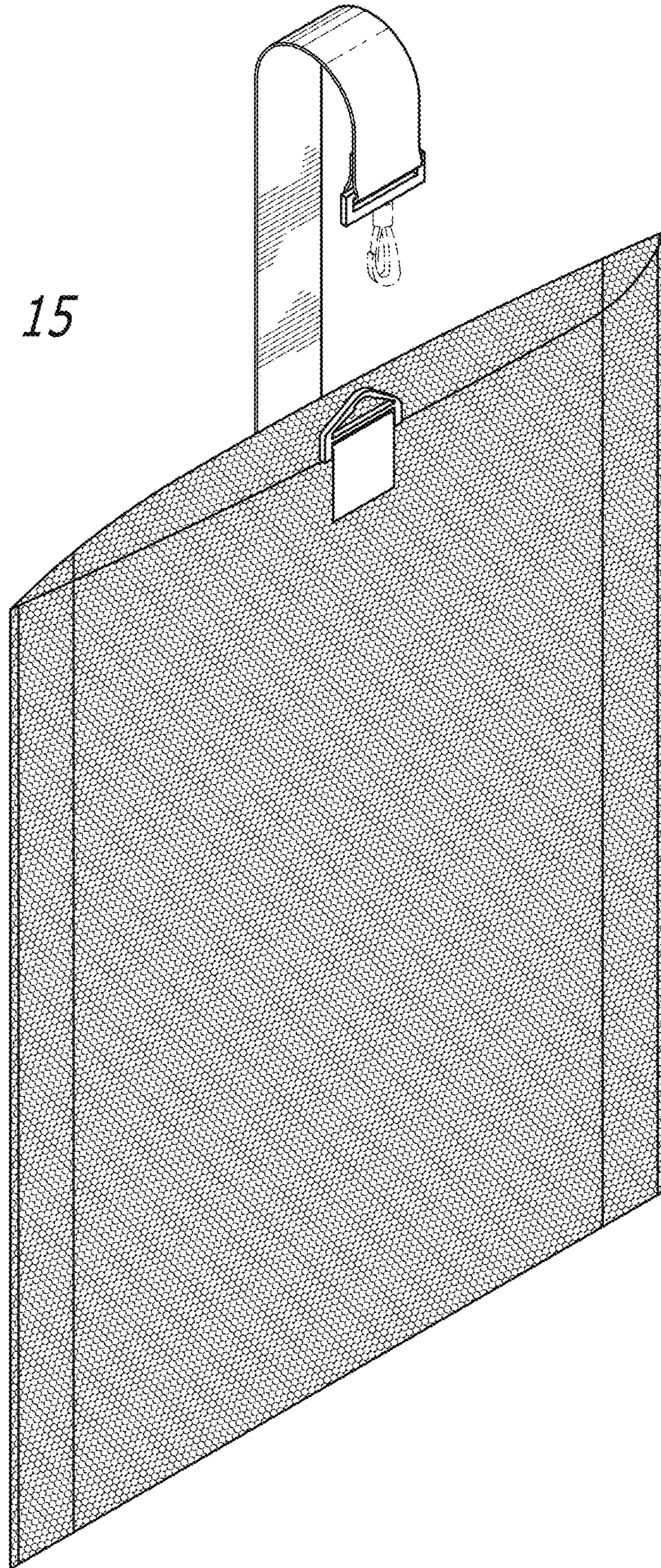

FIG. 16

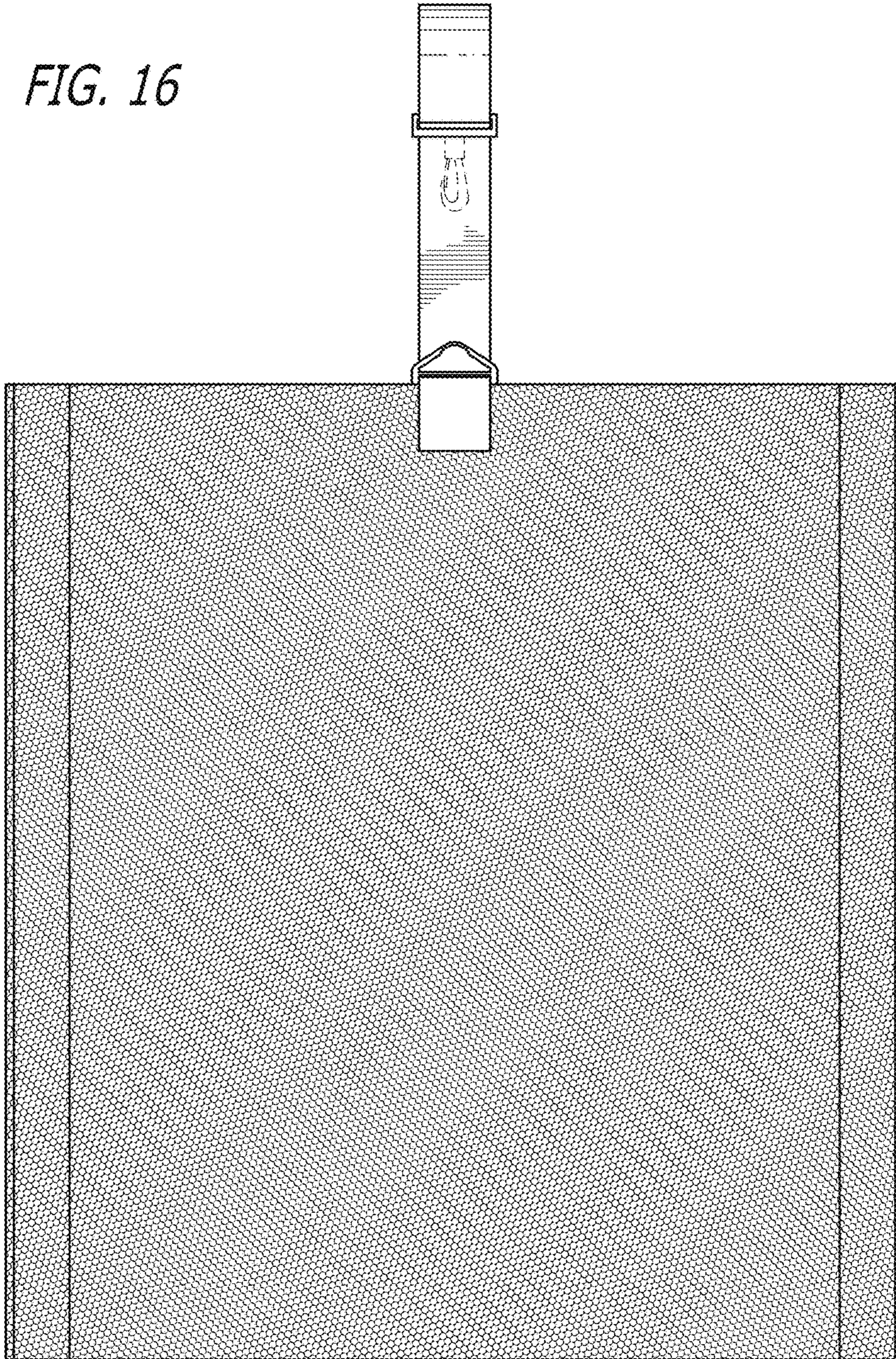
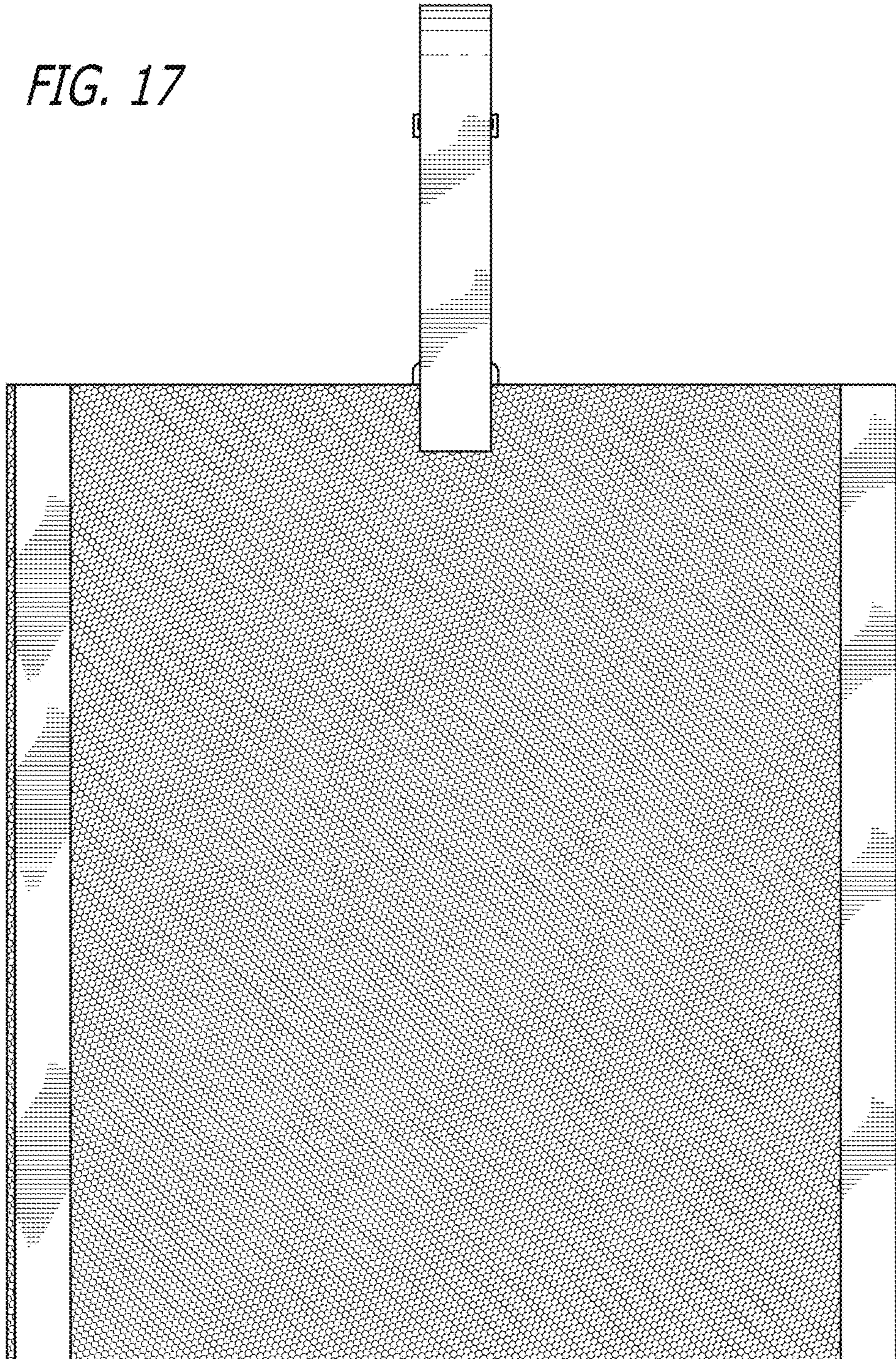

FIG. 17



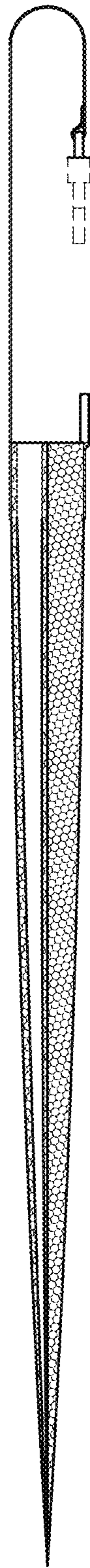
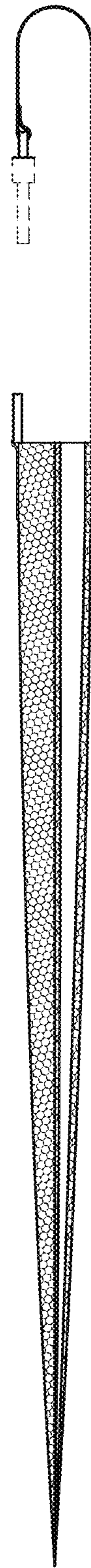

FIG. 18

FIG. 19



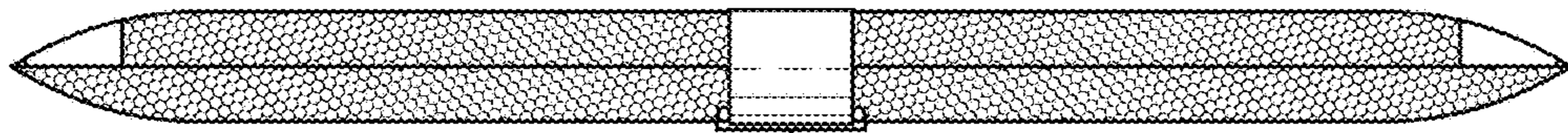

FIG. 20

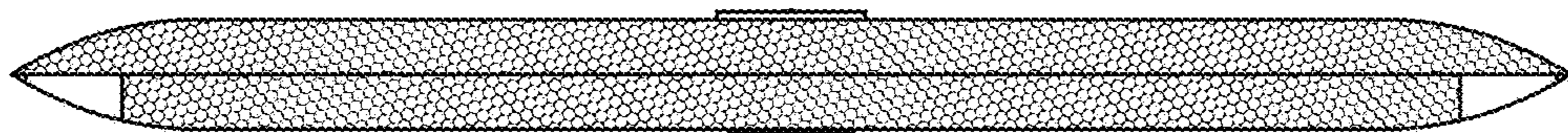

FIG. 21

FIG. 22

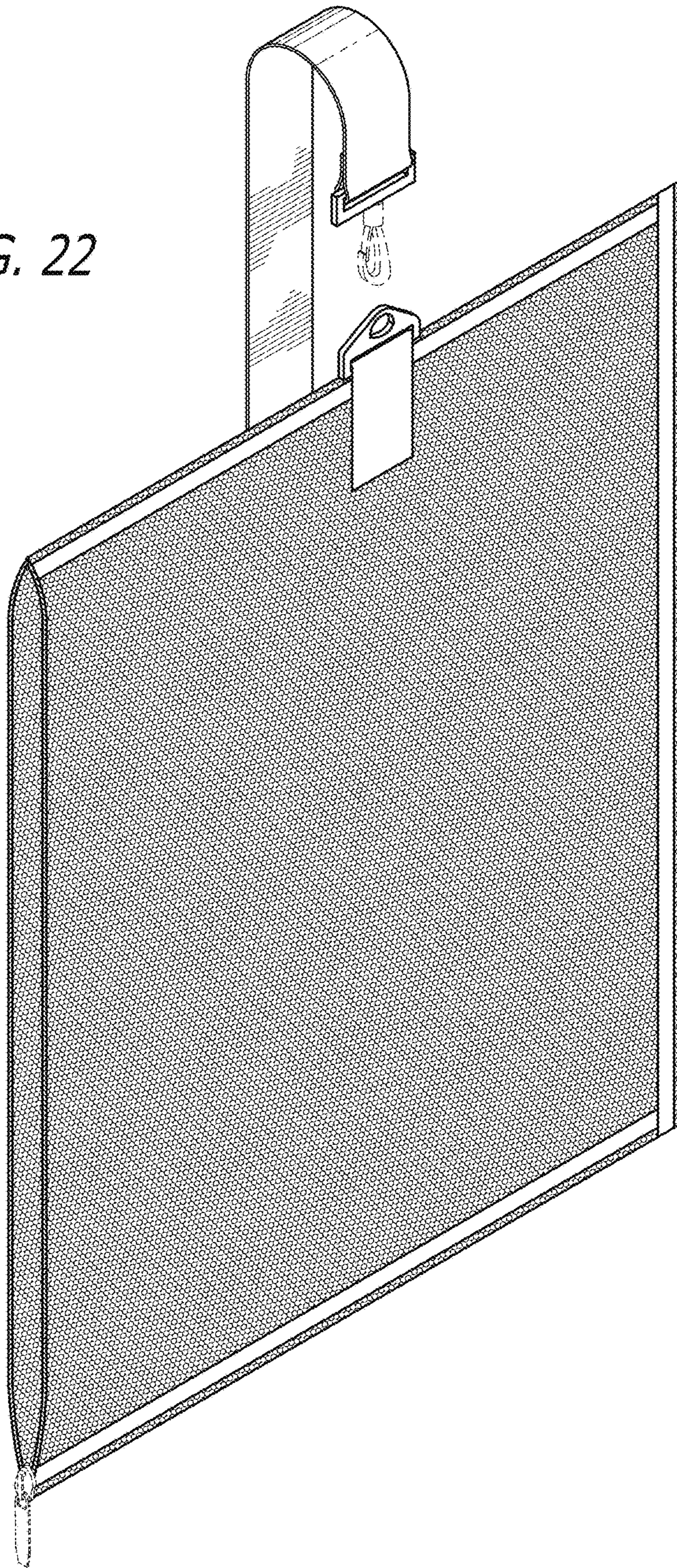

FIG. 23

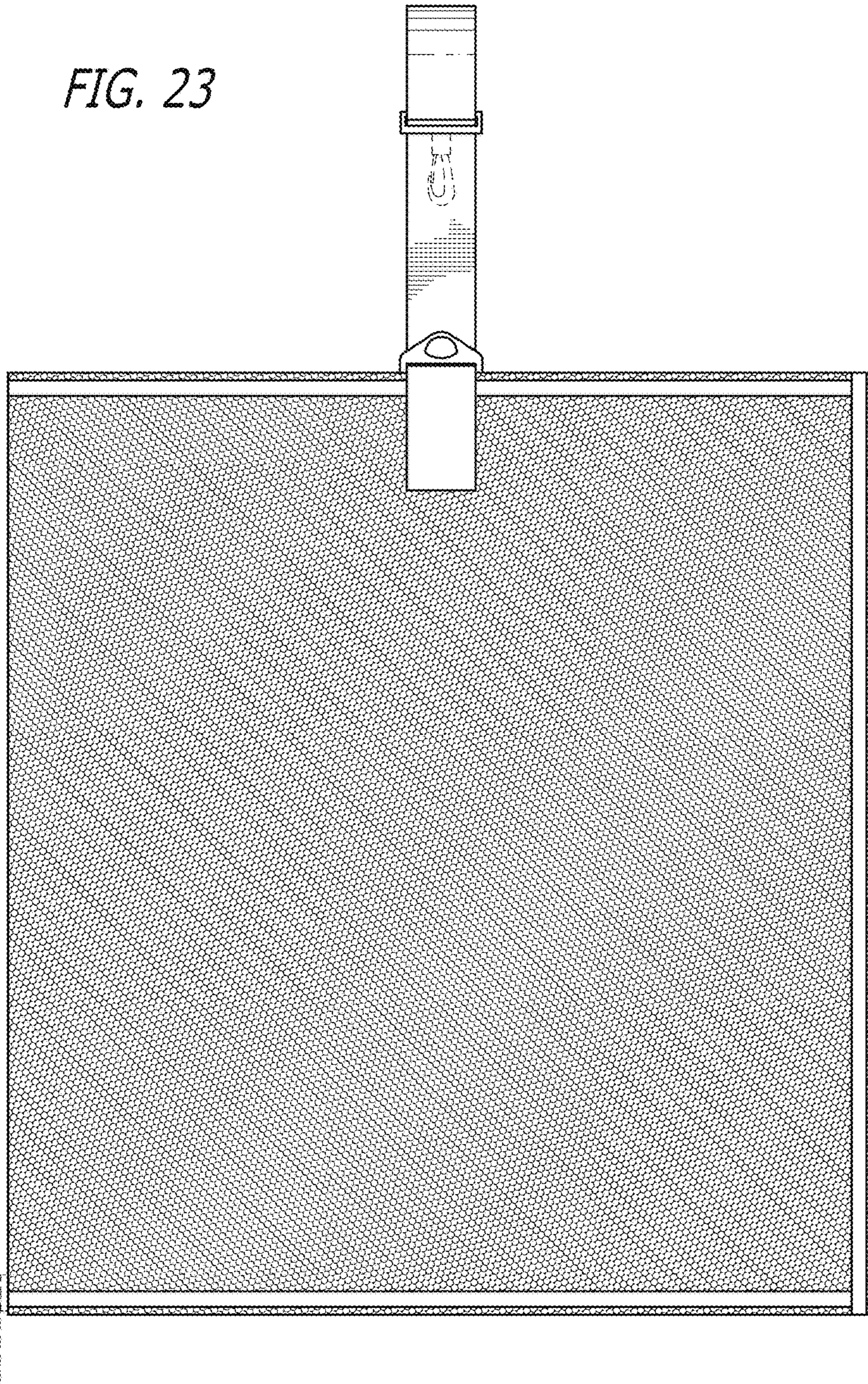
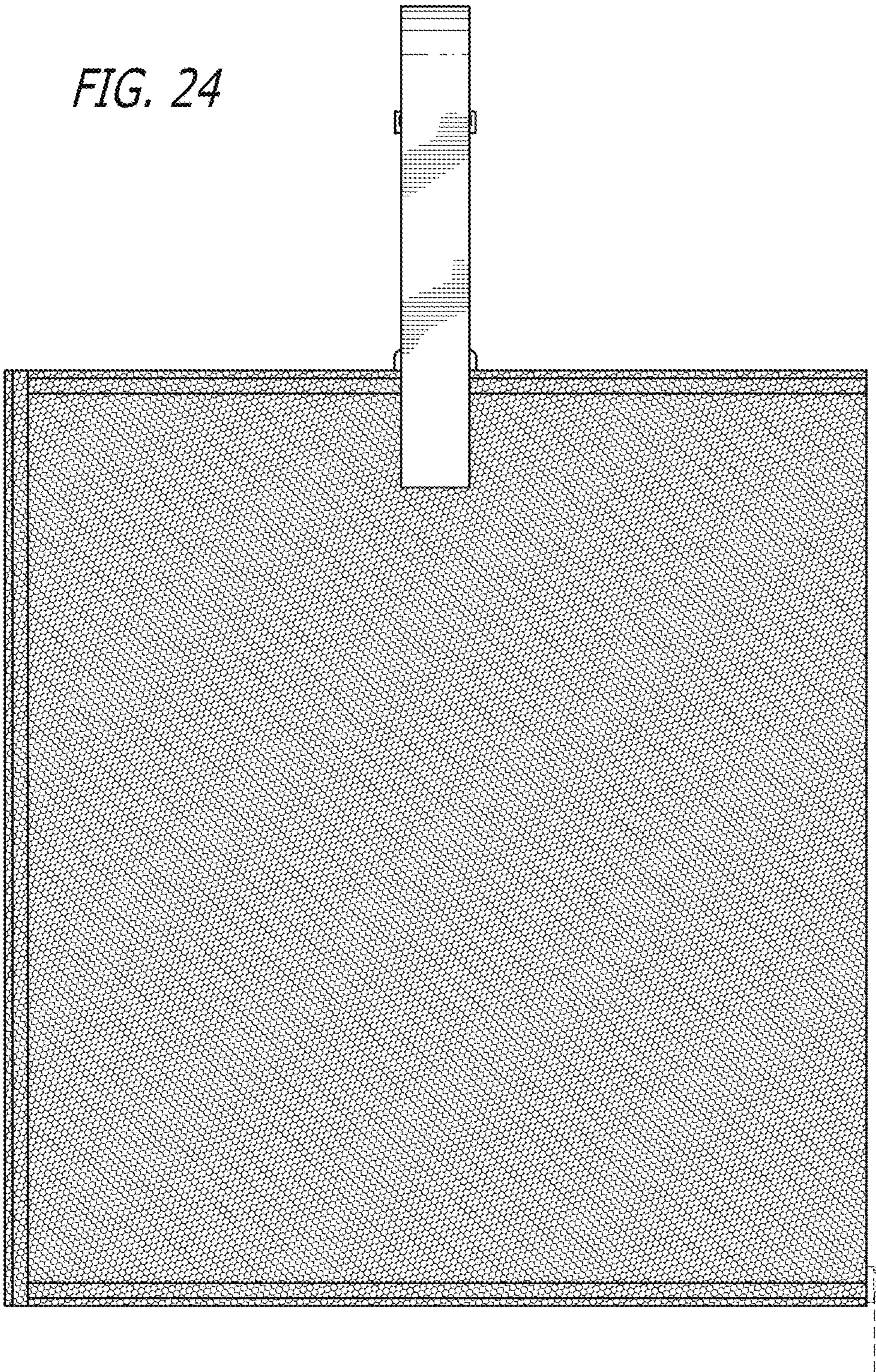

FIG. 24



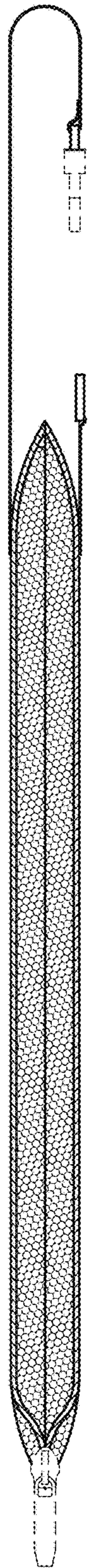
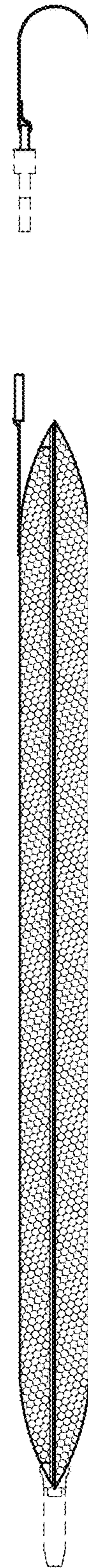

FIG. 25

FIG. 26



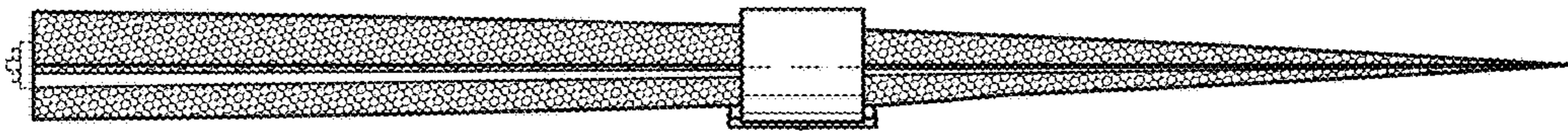

FIG. 27

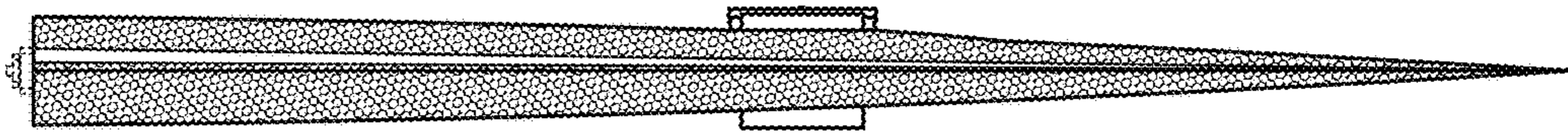

FIG. 28

FIG. 29

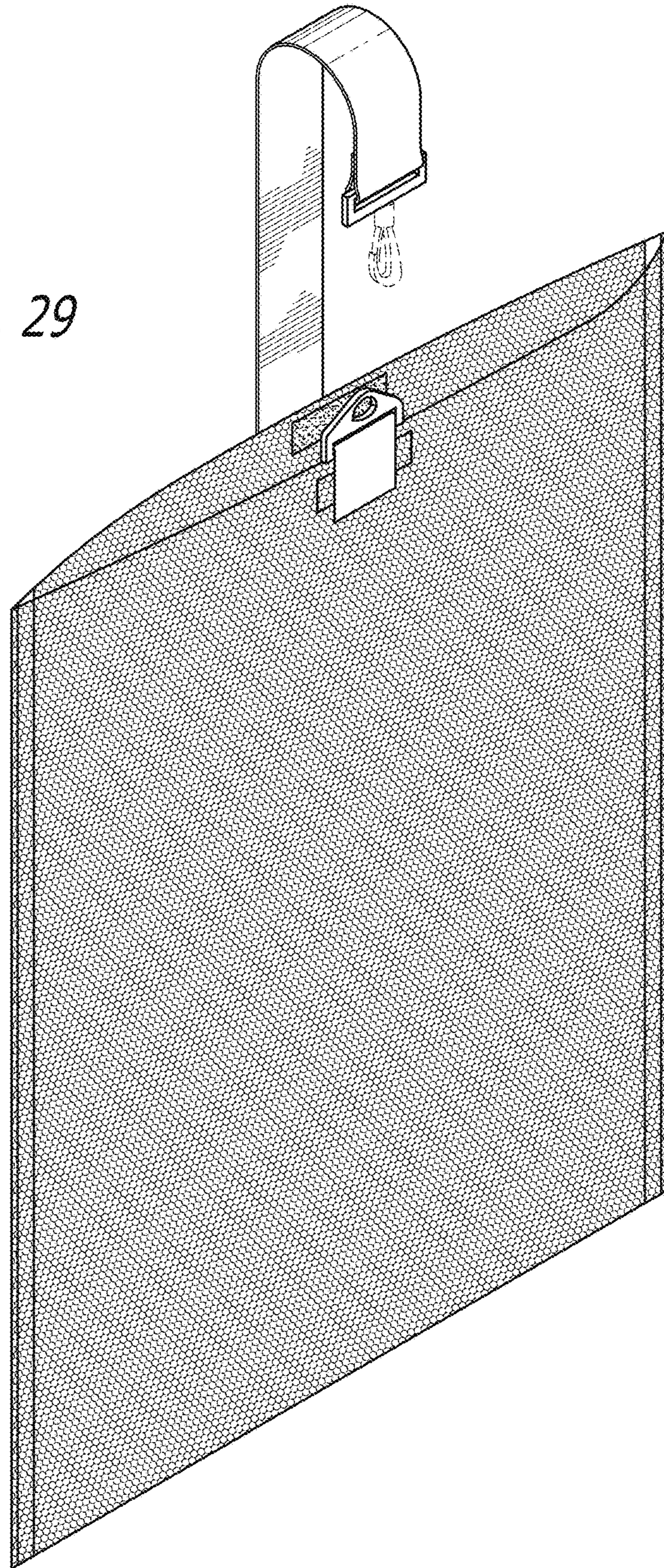

FIG. 30

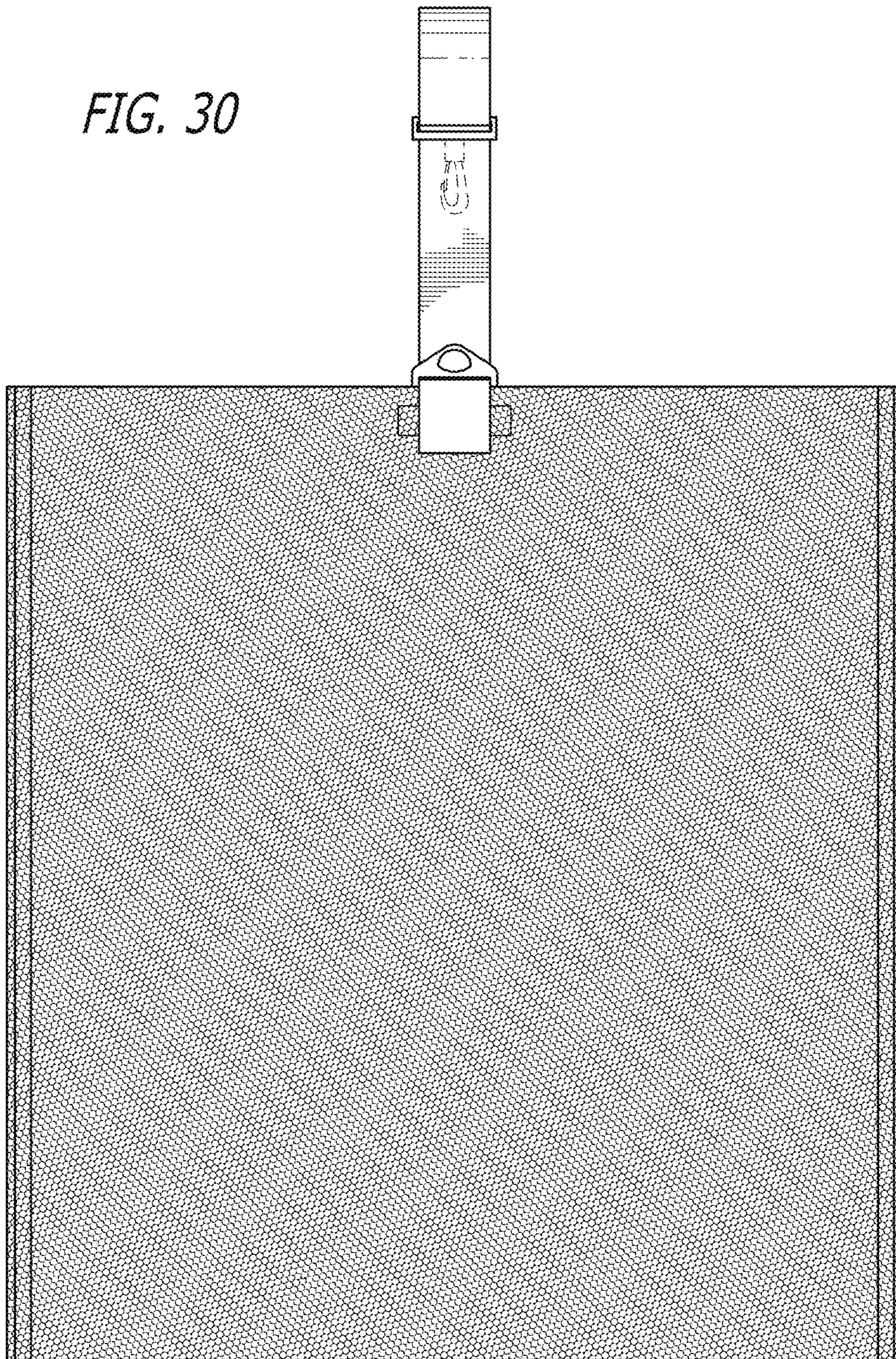
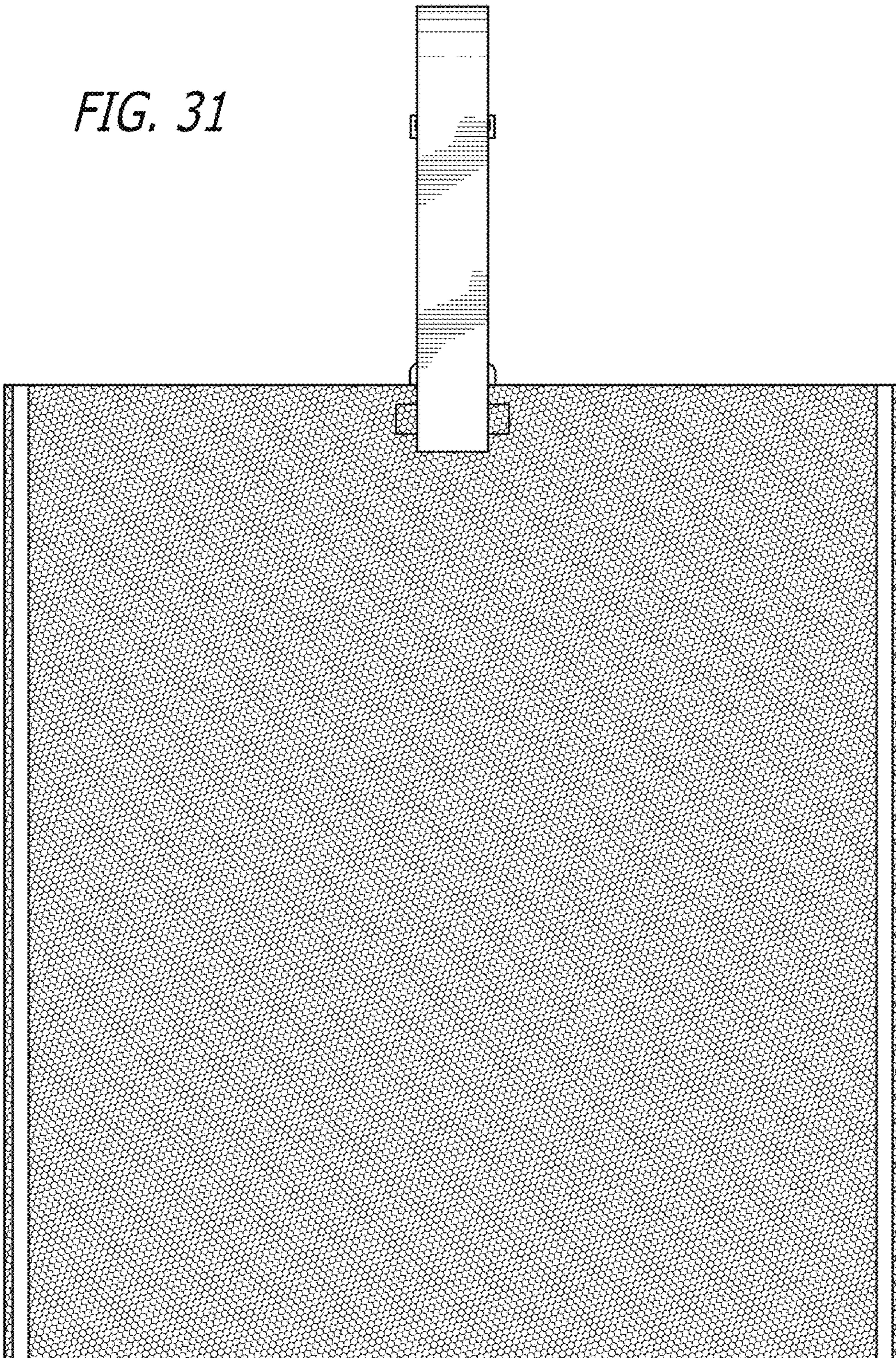

FIG. 31



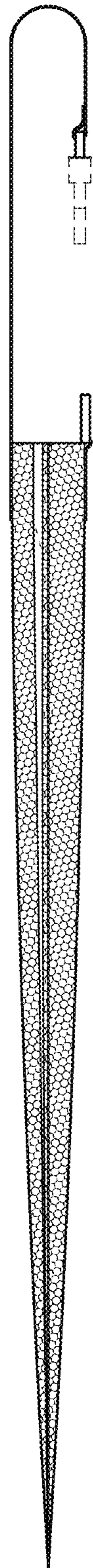
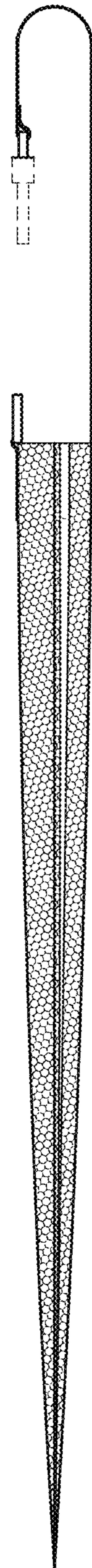

FIG. 32

FIG. 33



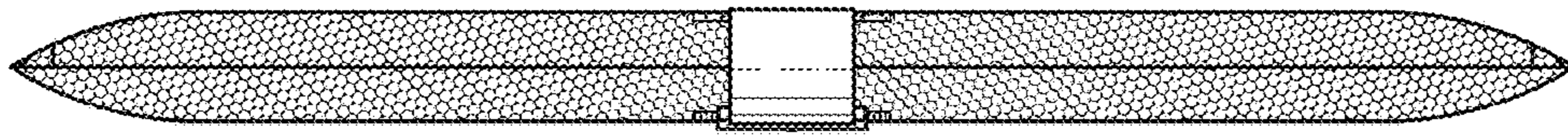

FIG. 34

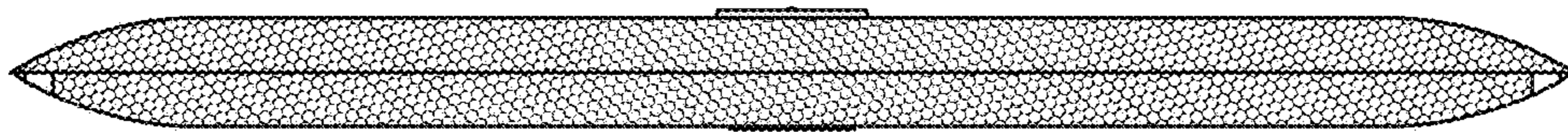

FIG. 35

FIG. 36

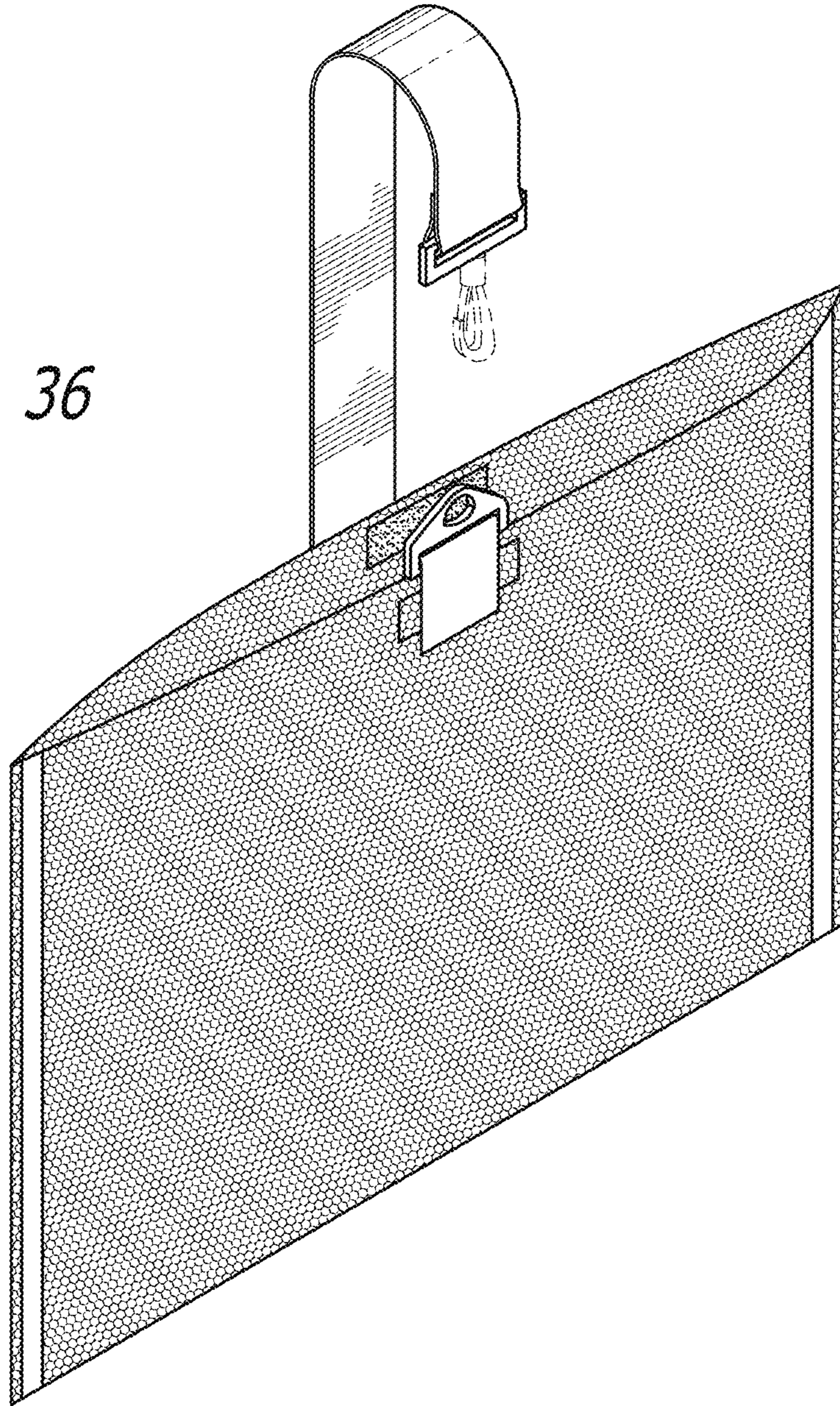

FIG. 37

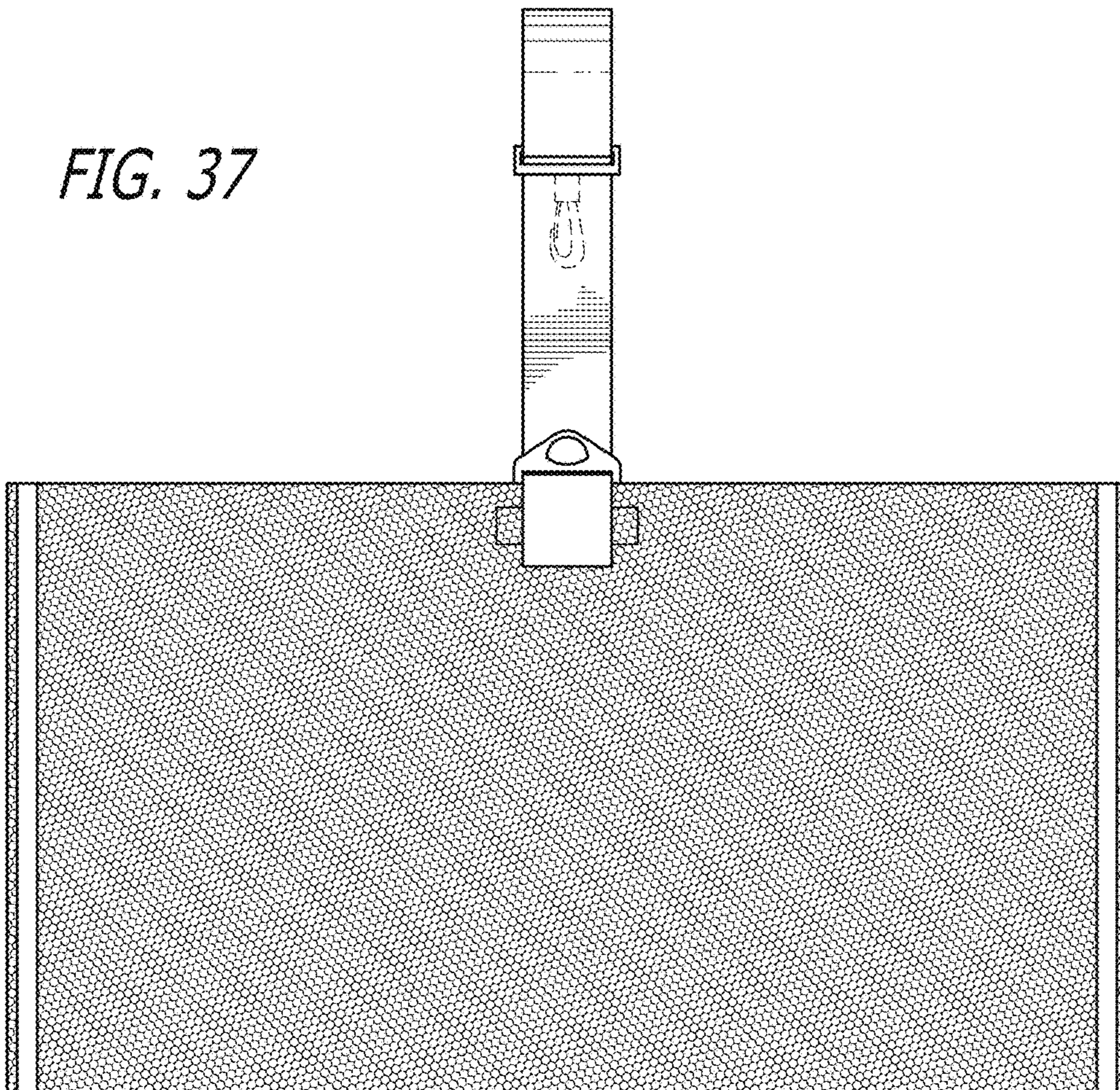
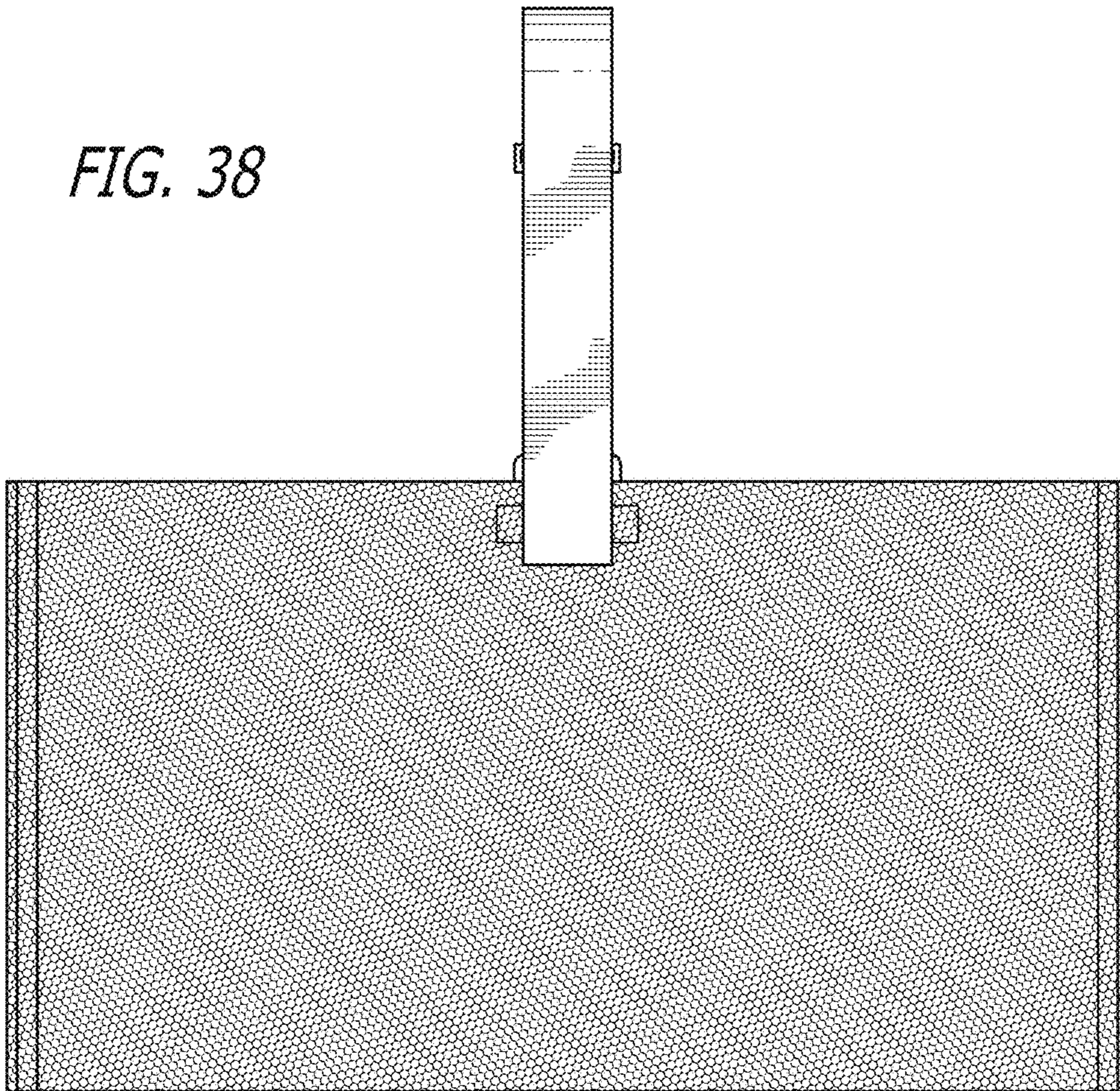

FIG. 38



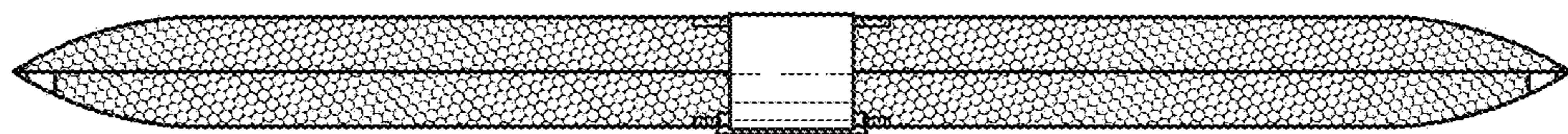
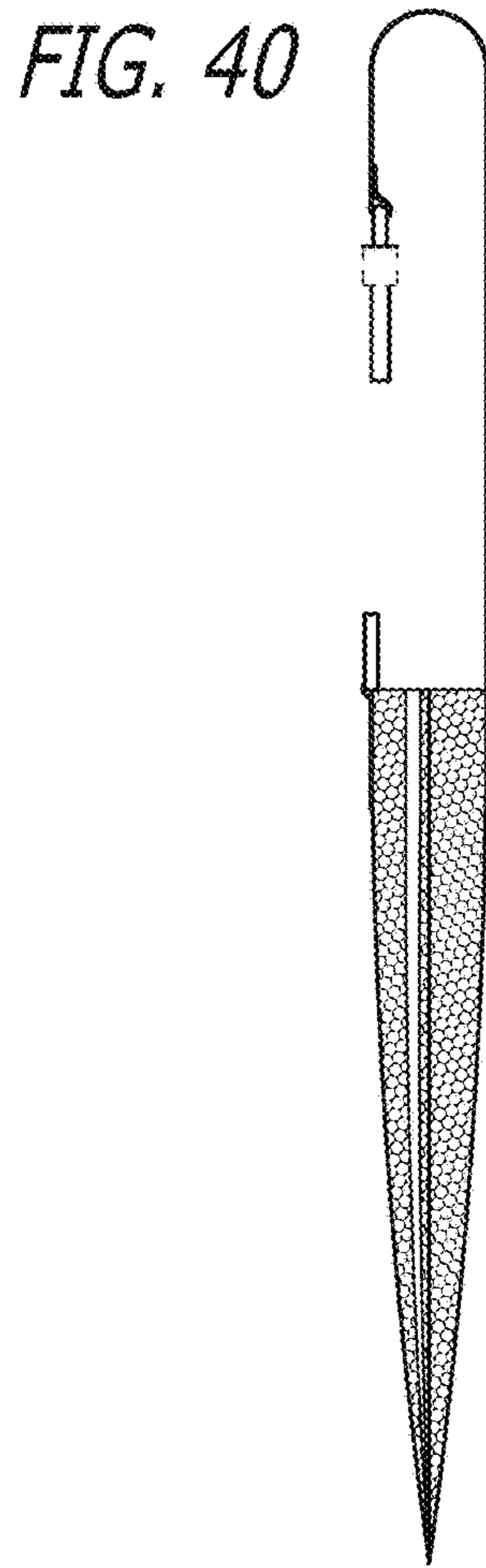
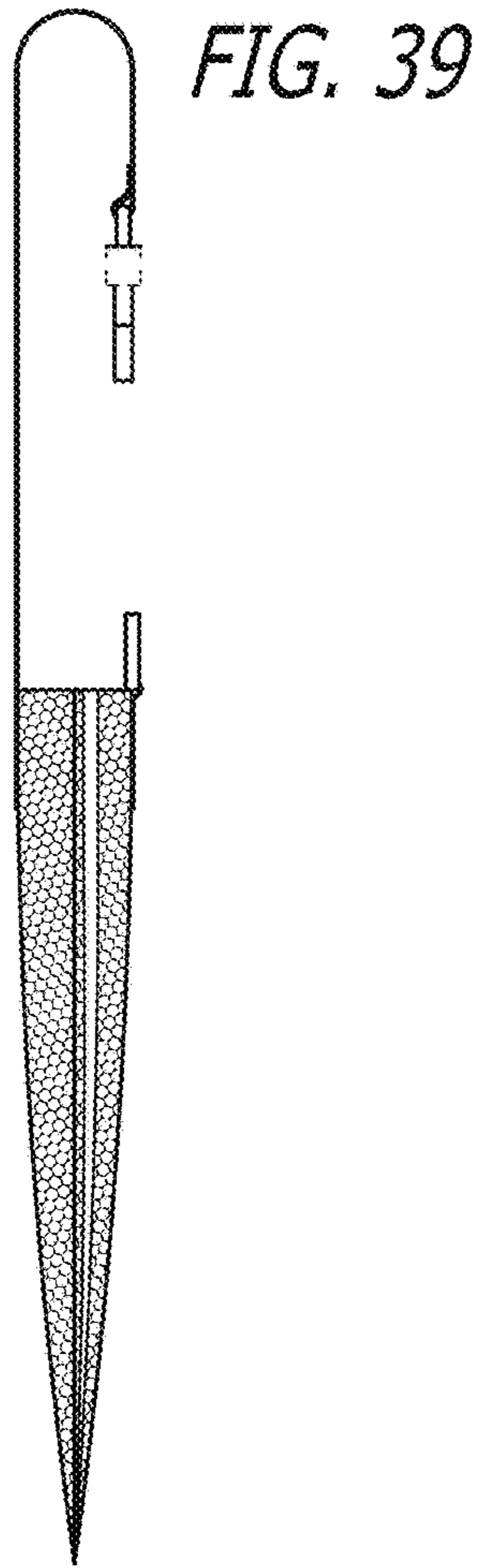

FIG. 41

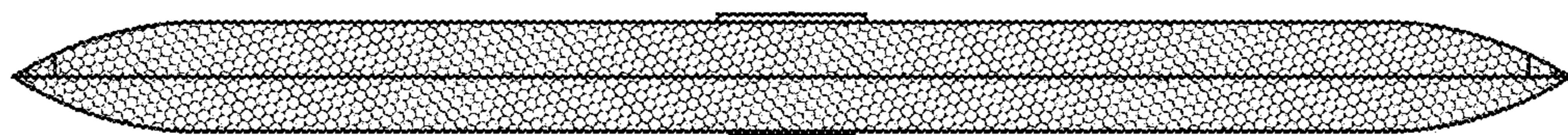

FIG. 42

FIG. 43

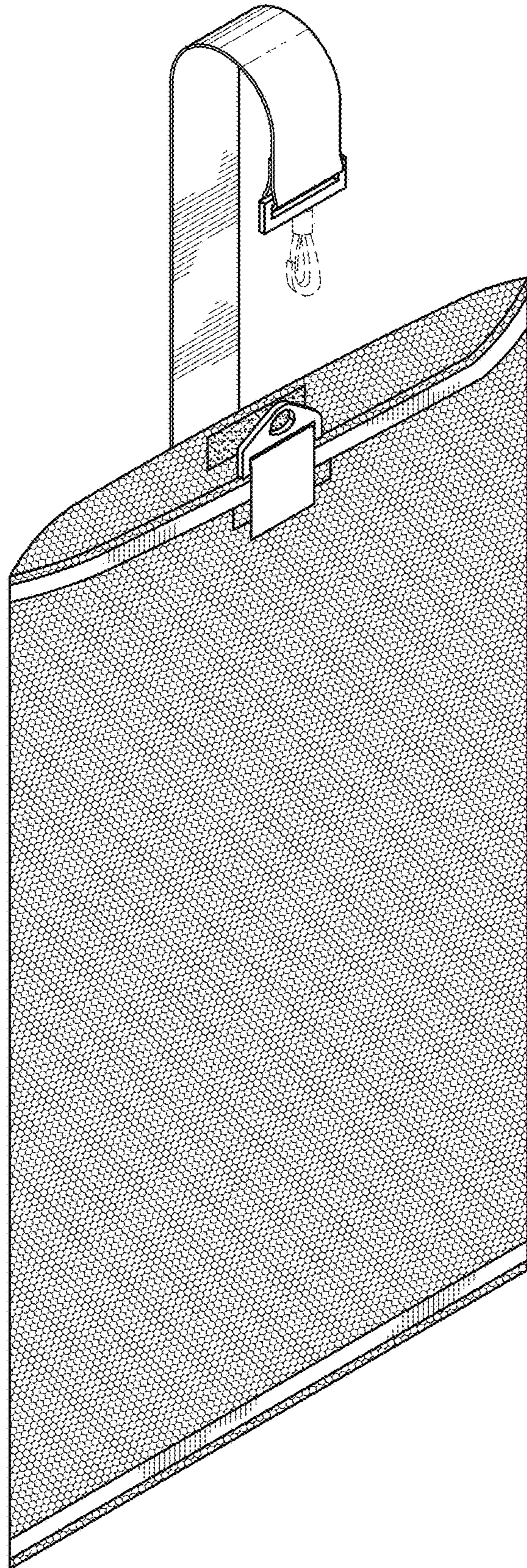

FIG. 44

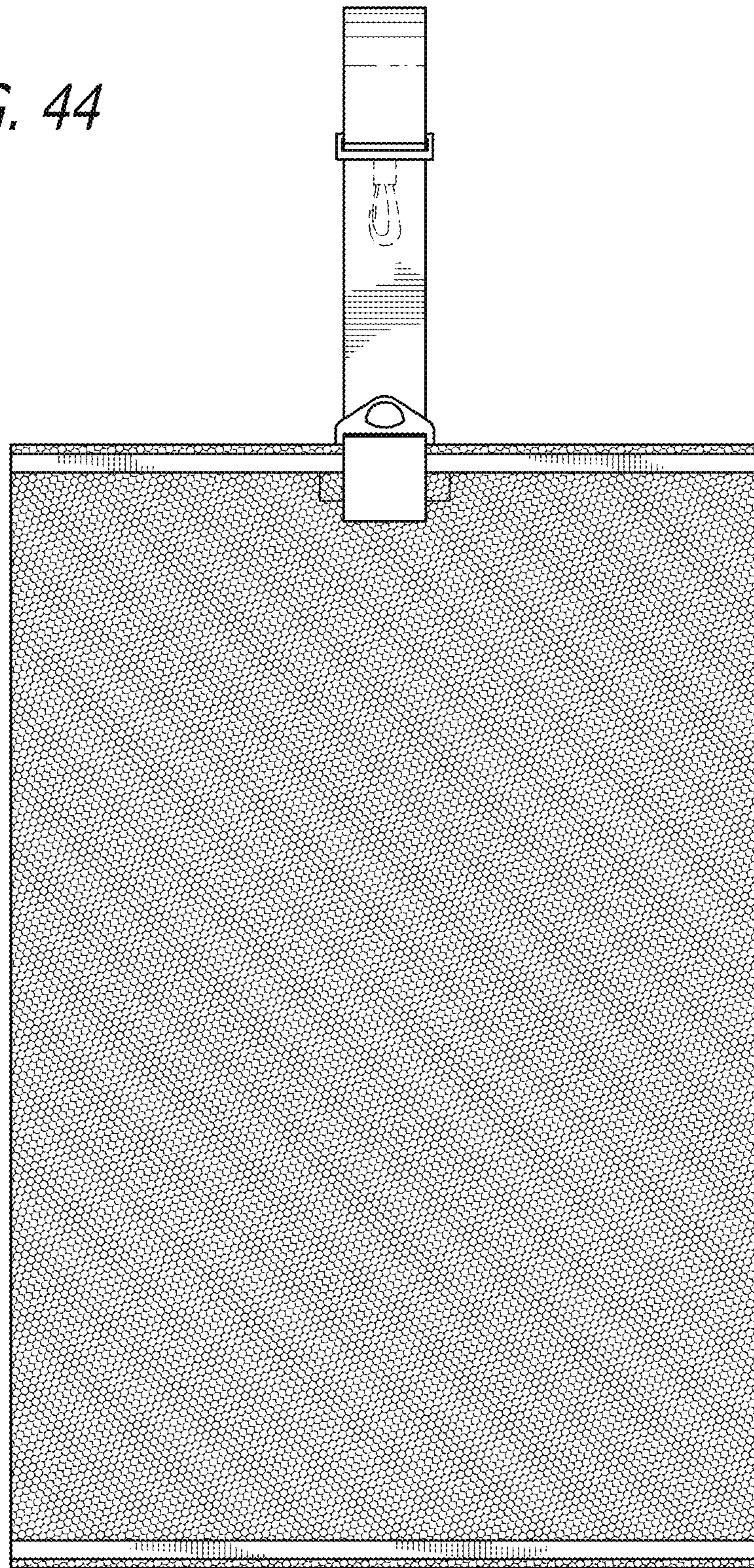
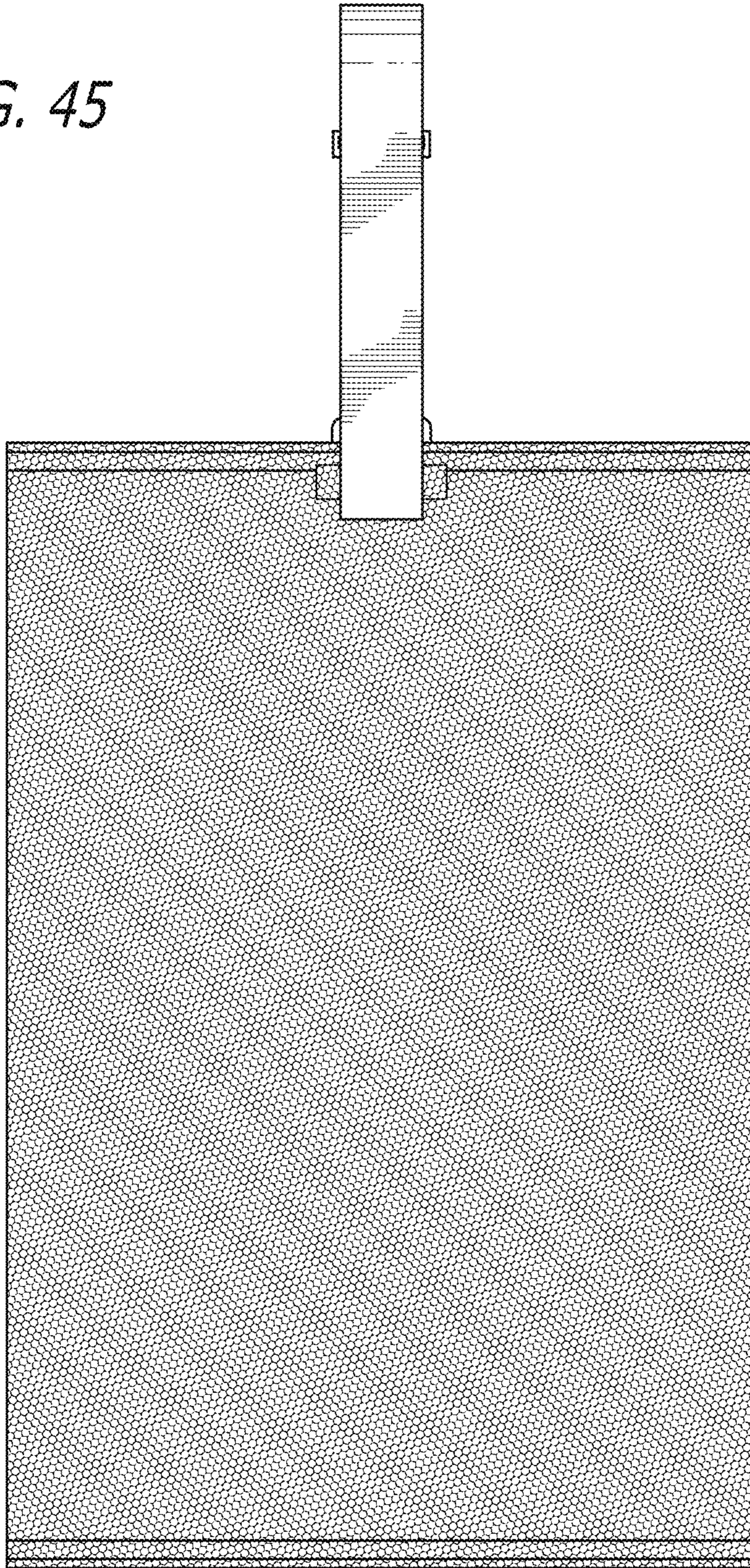

FIG. 45



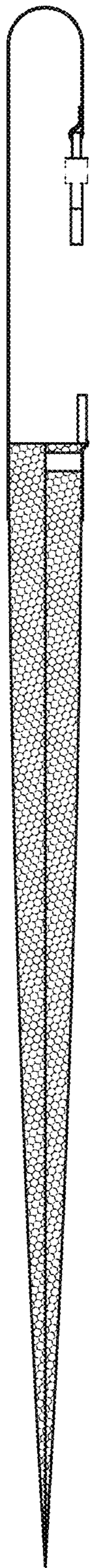
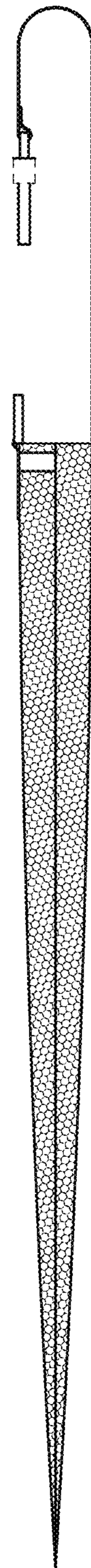

FIG. 46

FIG. 47



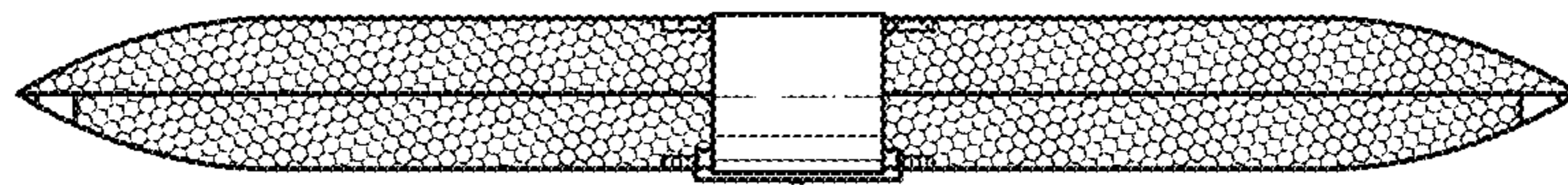

FIG. 48

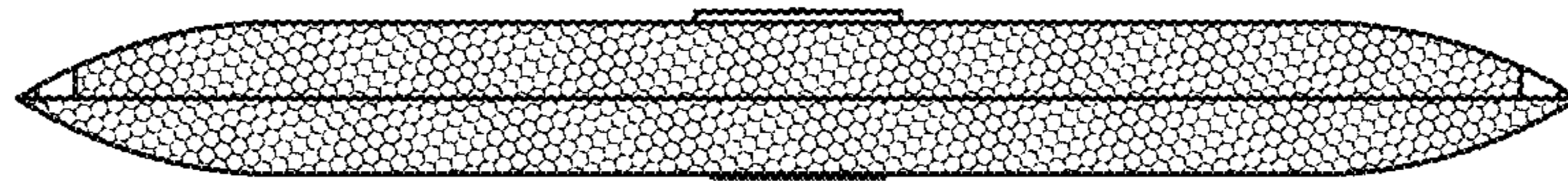

FIG. 49