



US00D831331S

(12) **United States Design Patent** (10) **Patent No.:** **US D831,331 S**
Lee et al. (45) **Date of Patent:** **** Oct. 23, 2018**

(54) **PILL BOX** 6,000,546 A * 12/1999 Noble A61J 1/03
206/1.5
(71) Applicant: **E-LINK PLASTIC & METAL** D418,288 S * 1/2000 Priebe D3/201
IND.CO., LTD., New Taipei (TW) D430,392 S * 9/2000 Noble D3/201
D457,819 S * 5/2002 Noble D10/40
(72) Inventors: **Cheng-Hua Lee,** New Taipei (TW); D466,801 S * 12/2002 Holland D3/203.3
Chien-Chen Liu, New Taipei (TW) D528,782 S * 9/2006 Oas D3/203.3
7,387,207 B2 * 6/2008 Priebe A61J 1/03
206/532

(73) Assignee: **E-LINK PLASTIC & METAL**
IND.CO., LTD., New Taipei (TW)

(**) Term: **15 Years**

(21) Appl. No.: **29/624,674**

(22) Filed: **Nov. 2, 2017**

(51) **LOC (11) Cl.** **03-01**

(52) **U.S. Cl.**
USPC **D3/203.3**

(58) **Field of Classification Search**
USPC D3/201, 203.1–203.8; D9/420, 421, 757,
D9/759
CPC B65D 75/372; B65D 83/0481; B65D 1/36;
B65D 83/04; B65D 83/0445; B65D
2583/04; A61J 7/04; A61J 1/03
See application file for complete search history.

(56) **References Cited**

U.S. PATENT DOCUMENTS

D227,552 S * 7/1973 Bridges et al. D3/203.3
D271,081 S * 10/1983 Noble D3/203.3
D281,225 S * 11/1985 Leman D3/203.3
4,735,318 A * 4/1988 Keffeler A61J 1/03
206/532
D298,803 S * 12/1988 Ebling D3/203.3
4,793,492 A * 12/1988 Halbich A45C 11/24
206/538
D304,905 S * 12/1989 Zimmerman D3/203.3
D337,725 S * 7/1993 Bunin D3/203.3
D415,958 S * 11/1999 Noble D3/203.3

(Continued)

Primary Examiner — John Windmuller

Assistant Examiner — Steven J Czyz

(74) *Attorney, Agent, or Firm* — Chun-Ming Shih

(57) **CLAIM**

The ornamental design for a pill box, as shown and described.

DESCRIPTION

FIG. 1 is a perspective view of a pill box showing my new design, wherein the pill box is in an open state;
FIG. 2 is a front view of the pill box in its open state;
FIG. 3 is a rear view of the pill box in its open state;
FIG. 4 is a left side view of the pill box in its open state;
FIG. 5 is a right side view of the pill box in its open state;
FIG. 6 is a top plan view of the pill box in its open state;
FIG. 7 is a bottom plan view of the pill box in its open state;
FIG. 8 is a perspective view of the pill box, shown in a closed state;
FIG. 9 is a front view of the pill box in its closed state;
FIG. 10 is a rear view of the pill box in its closed state;
FIG. 11 is a left side view of the pill box in its closed state;
FIG. 12 is a right side view of the pill box in its closed state;
FIG. 13 is a top plan view of the pill box in its closed state;
and,
FIG. 14 is a bottom plan view of the pill box in its closed state.

1 Claim, 12 Drawing Sheets

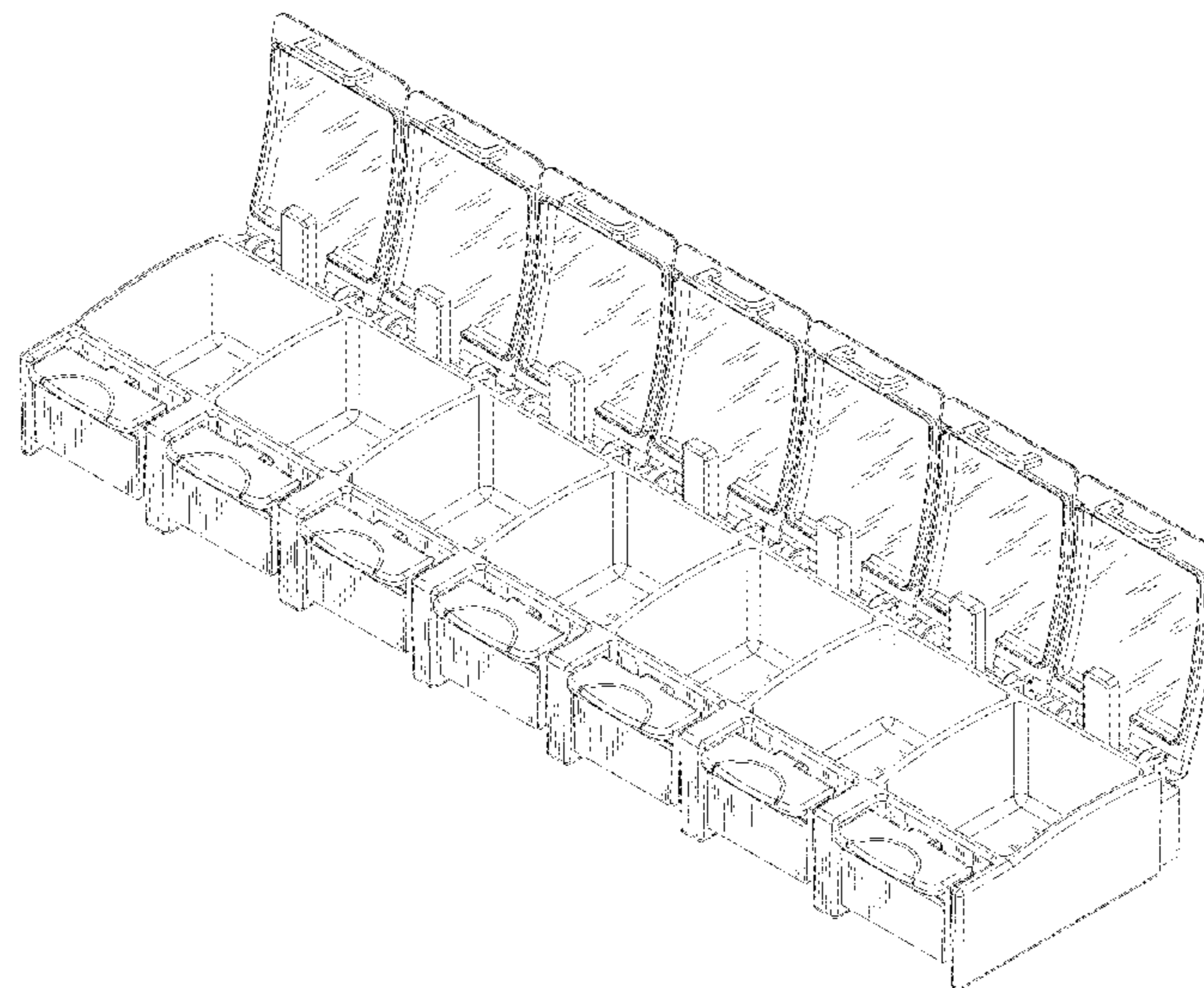

(56)

References Cited

U.S. PATENT DOCUMENTS

D587,005	S	*	2/2009	Gardner	D3/203.3
7,494,012	B1	*	2/2009	Priebe	A61J 1/03 206/1.5
7,798,330	B2	*	9/2010	Noble	B65D 83/04 206/1.5
D684,355	S	*	6/2013	Priebe	D3/203.3
D691,366	S	*	10/2013	Muncy	D3/203.3
D695,512	S	*	12/2013	Priebe	D3/203.3
D696,008	S	*	12/2013	Priebe	D3/203.3
D696,010	S	*	12/2013	Priebe	D3/203.3
D696,856	S	*	1/2014	Priebe	D3/203.3
D697,303	S	*	1/2014	Priebe	D3/203.3
D698,141	S	*	1/2014	Priebe	D3/203.3
D698,540	S	*	2/2014	Priebe	D3/203.3
D709,282	S	*	7/2014	Priebe	D3/203.3
D747,869	S	*	1/2016	Priebe	D3/203.3
D775,462	S	*	1/2017	Noble	D3/203.3

* cited by examiner

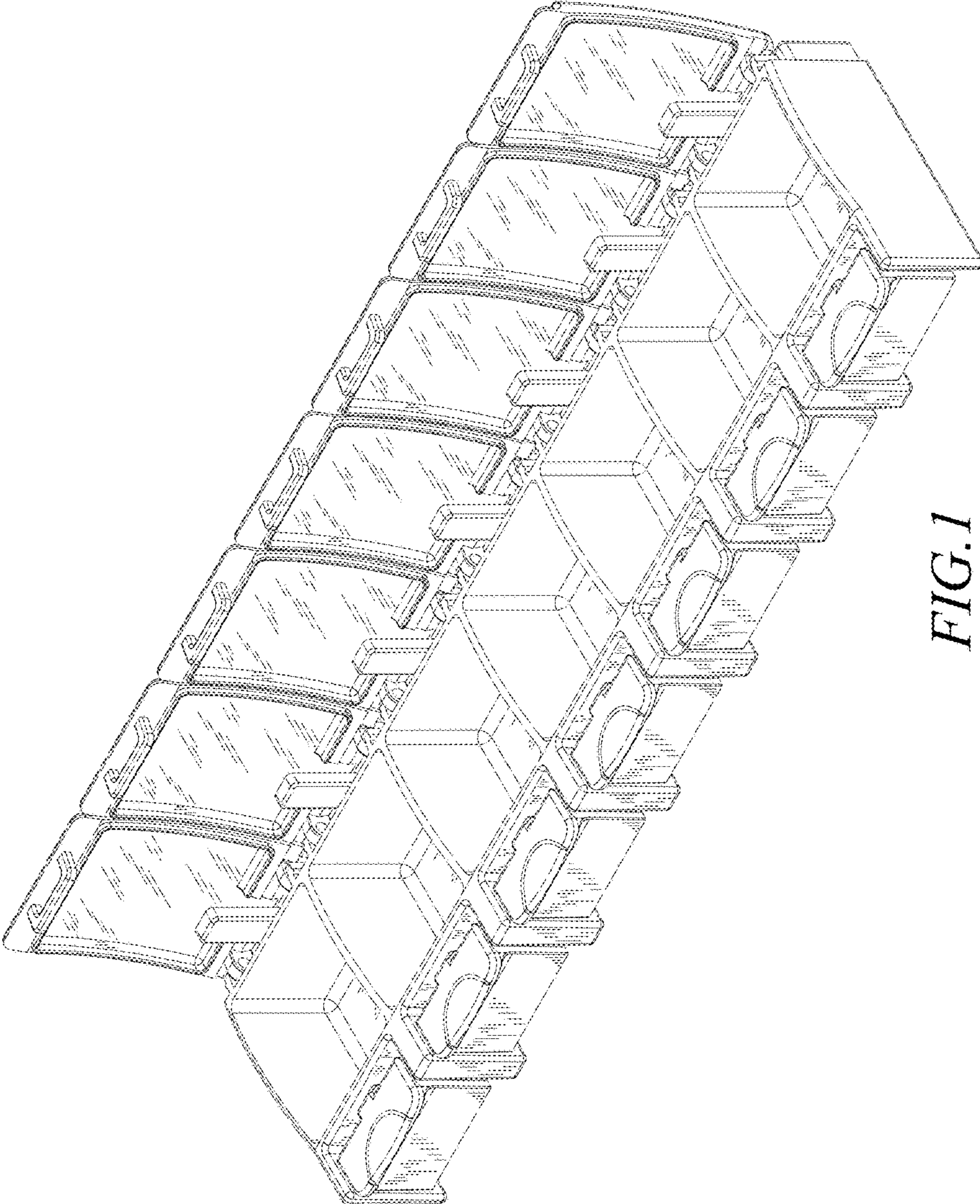

FIG. 1

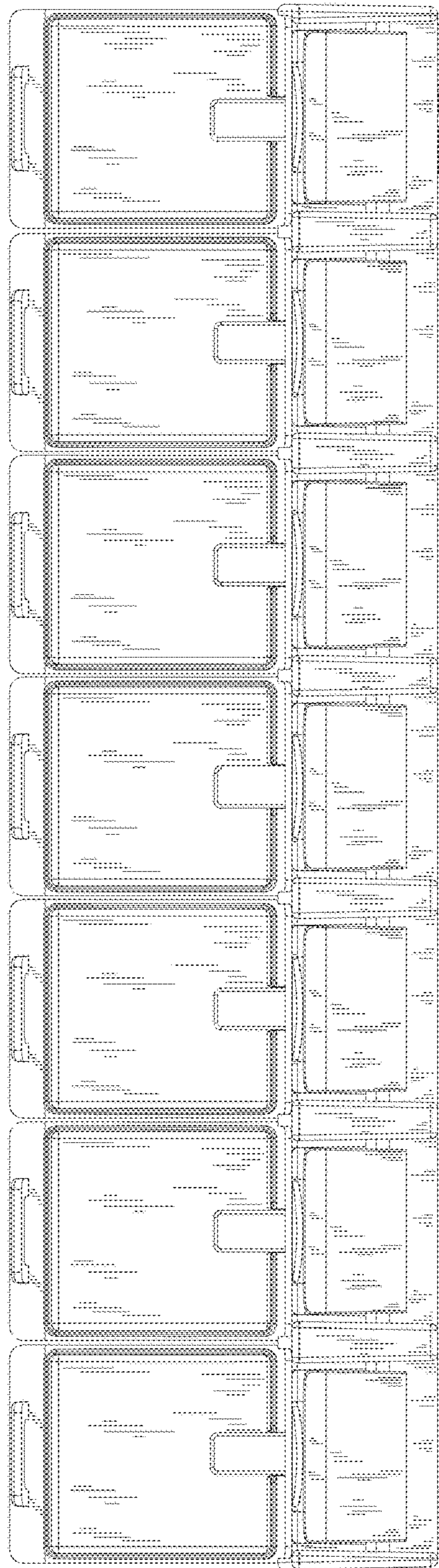

FIG. 2

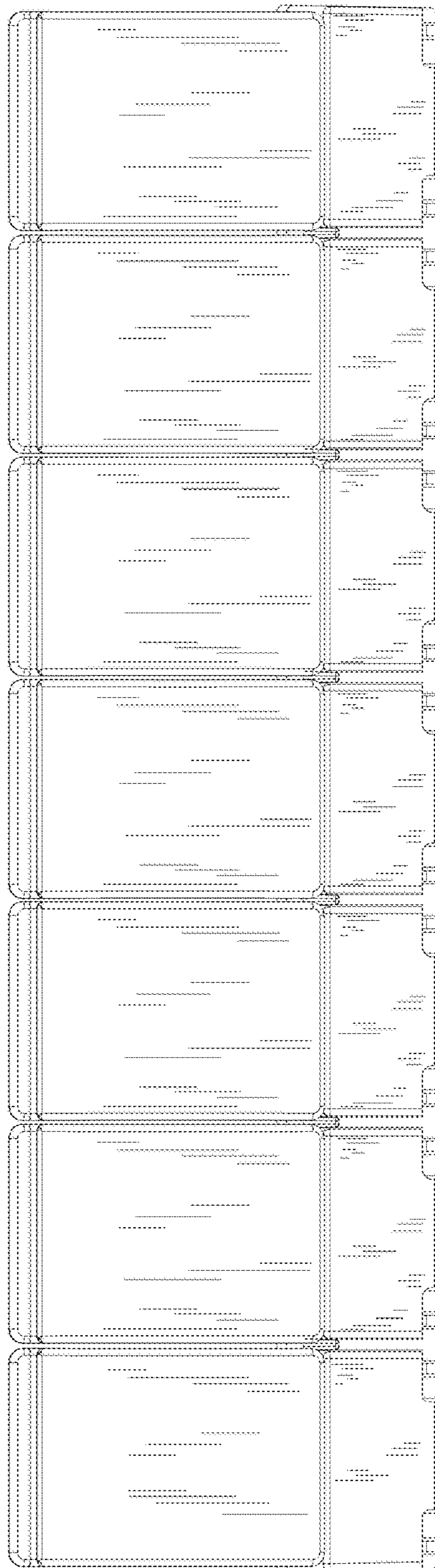

FIG. 3

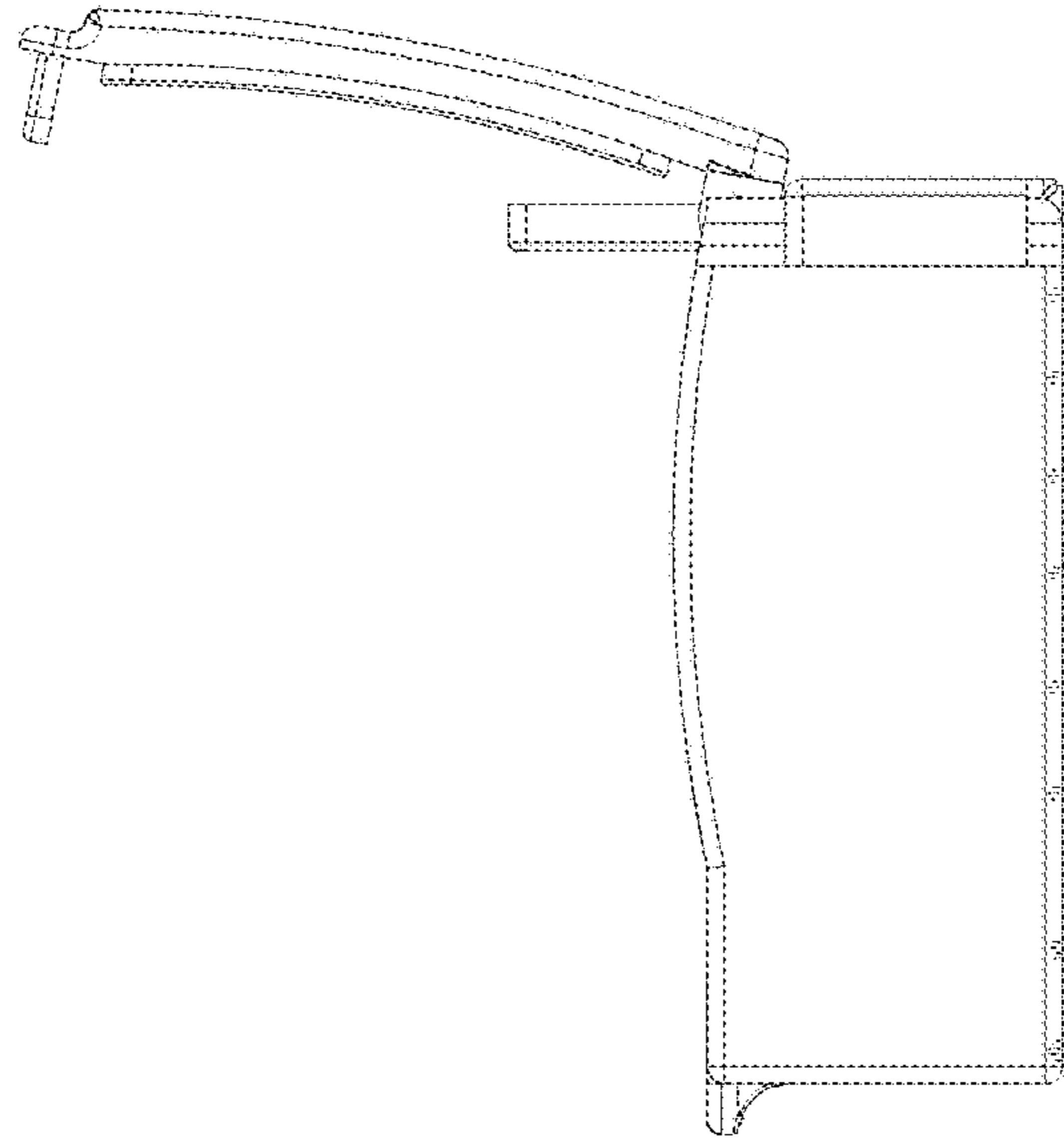

FIG. 5

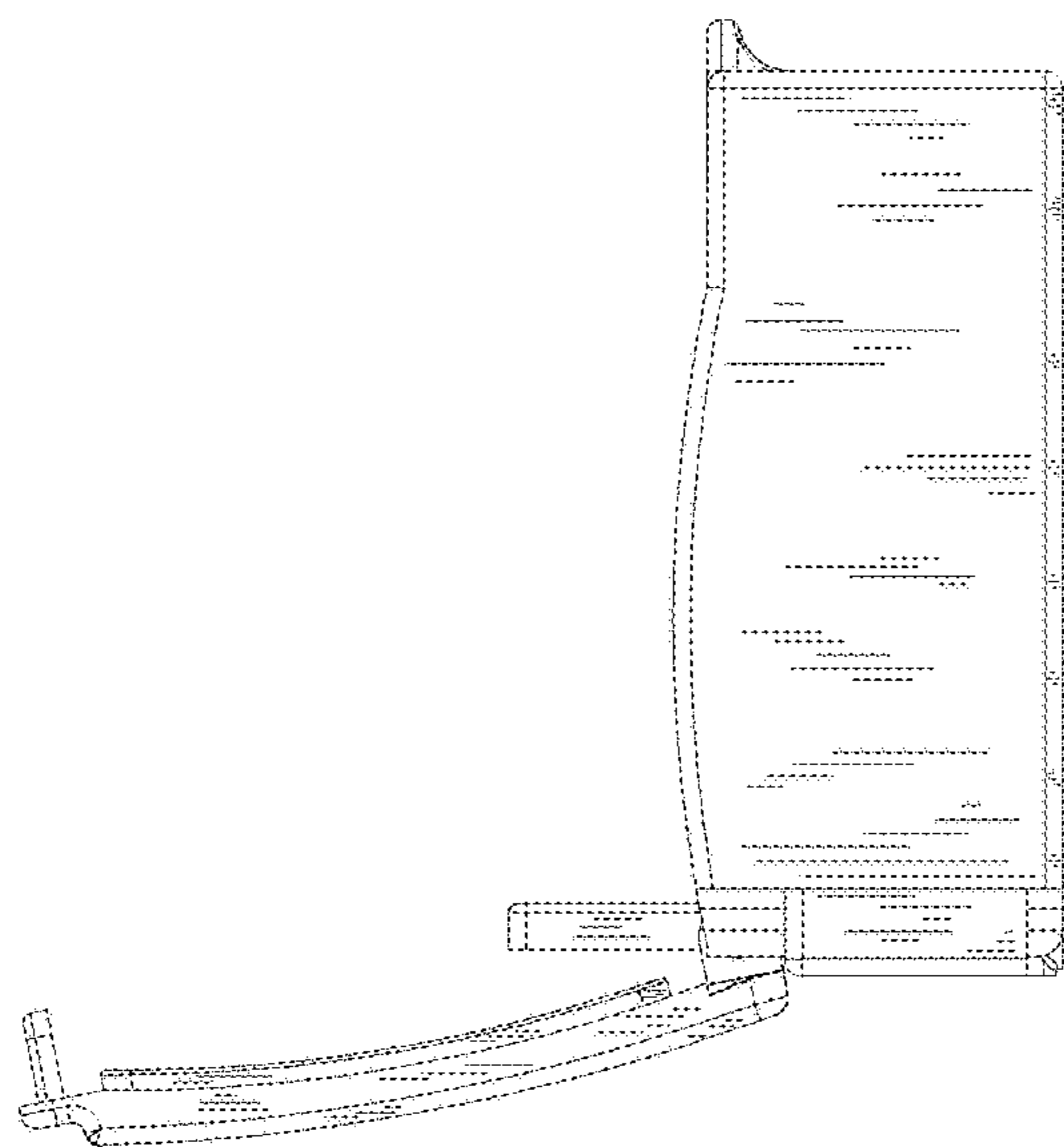

FIG. 4

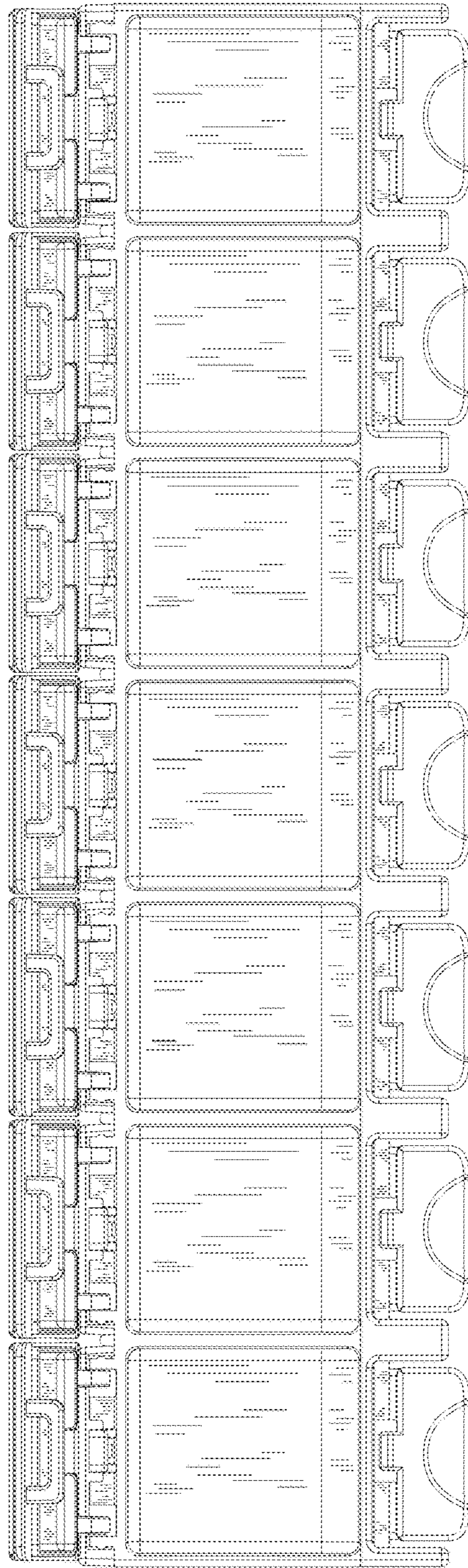

FIG. 6

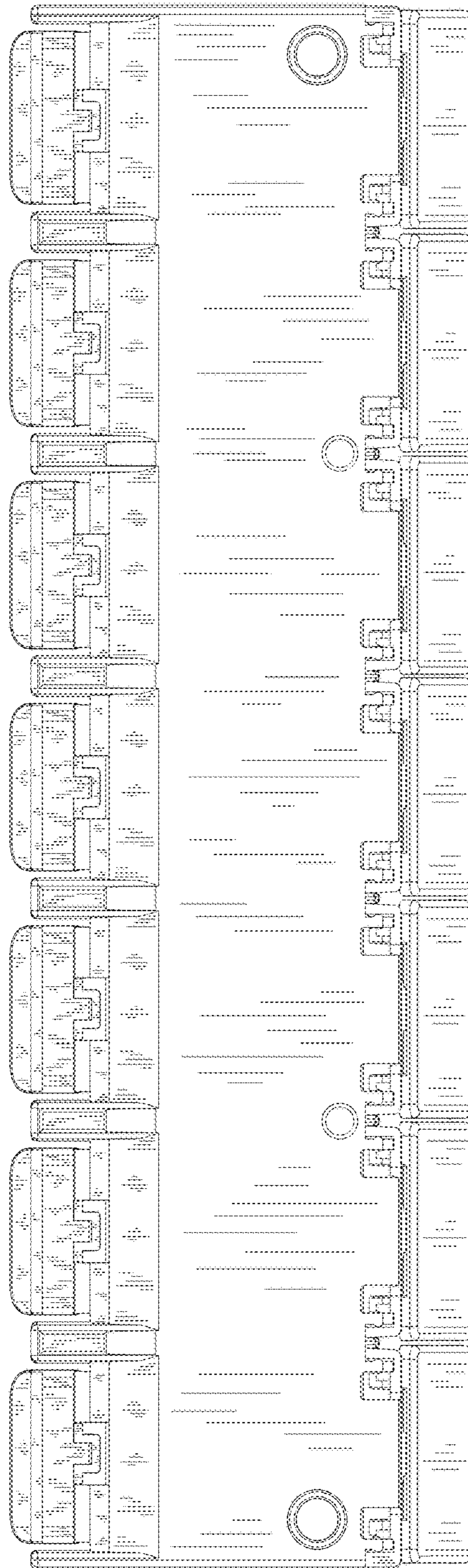

FIG. 7

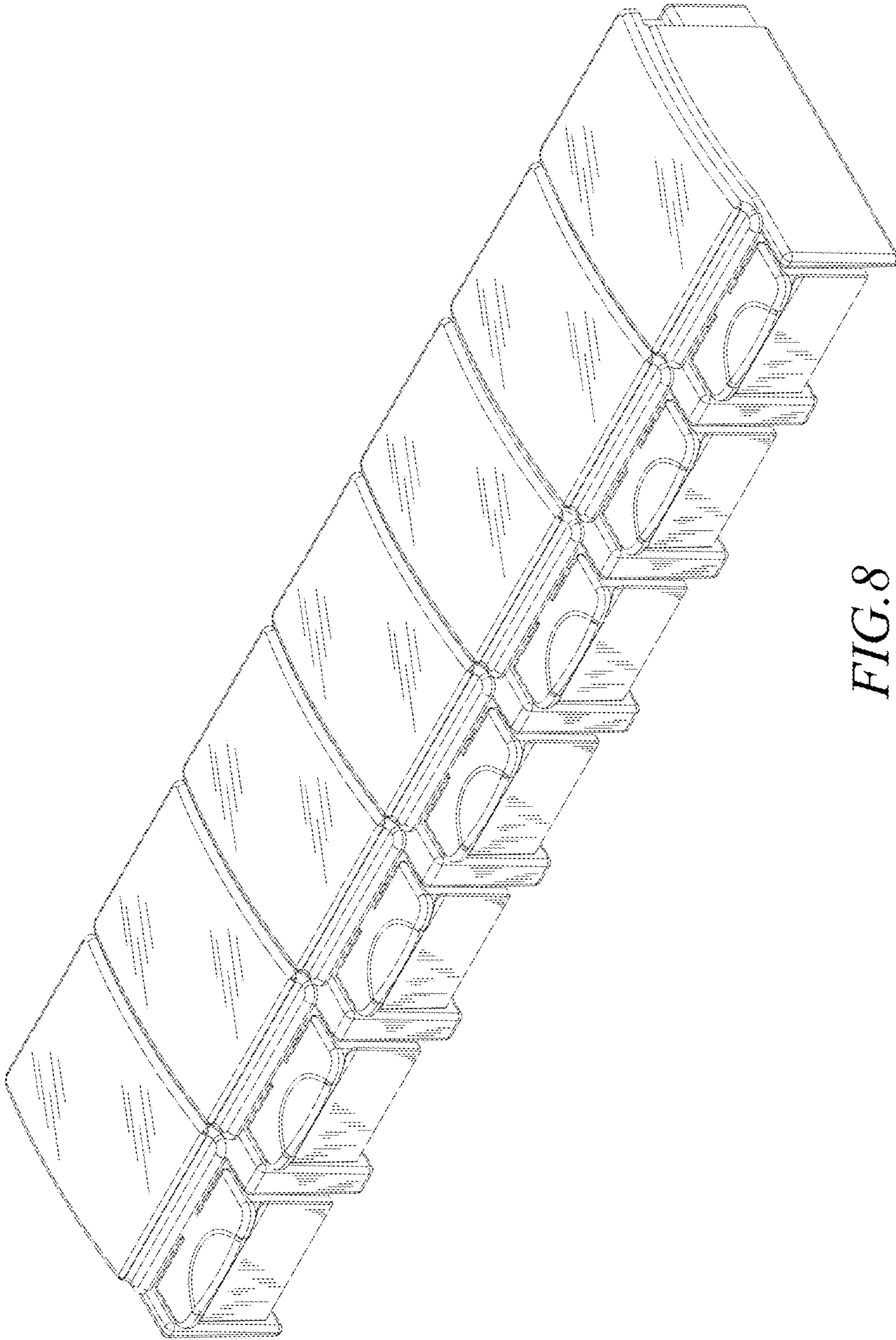

FIG. 8

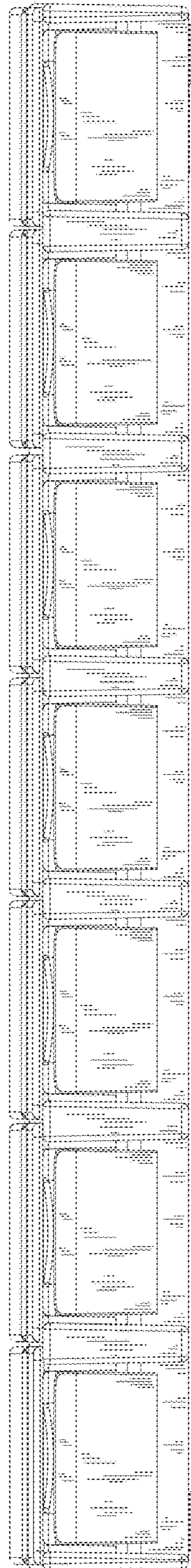

FIG. 9

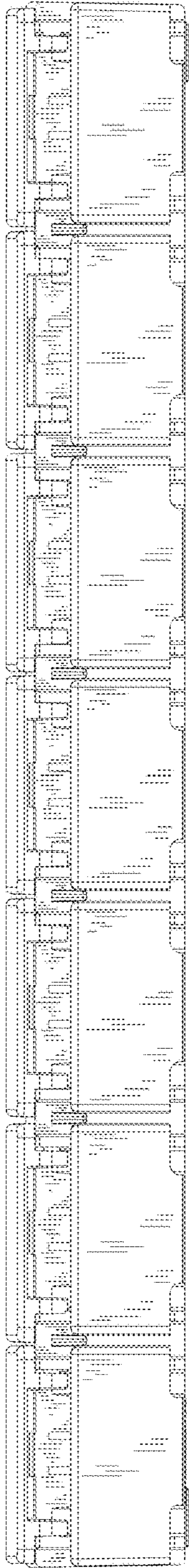

FIG. 10

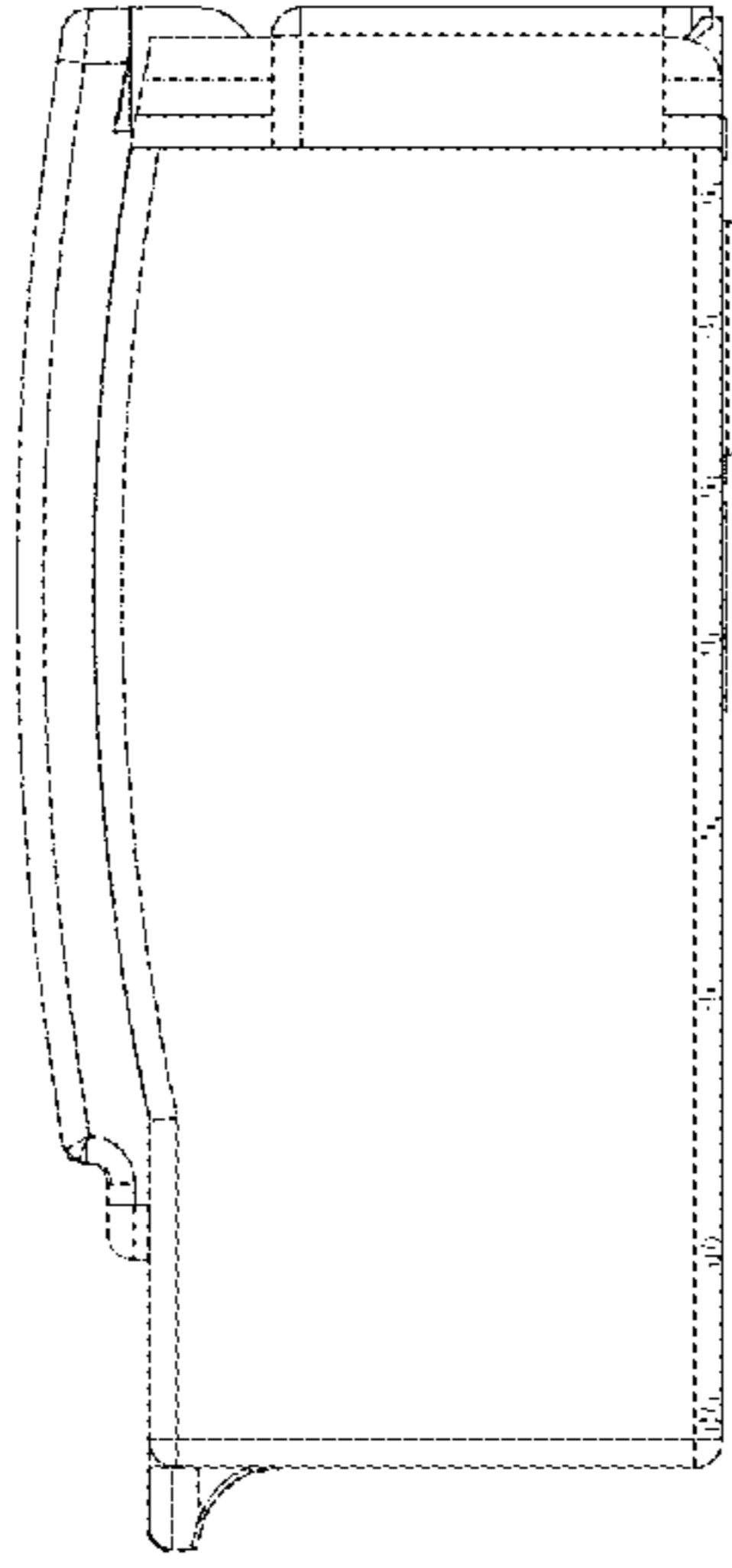

FIG. 12

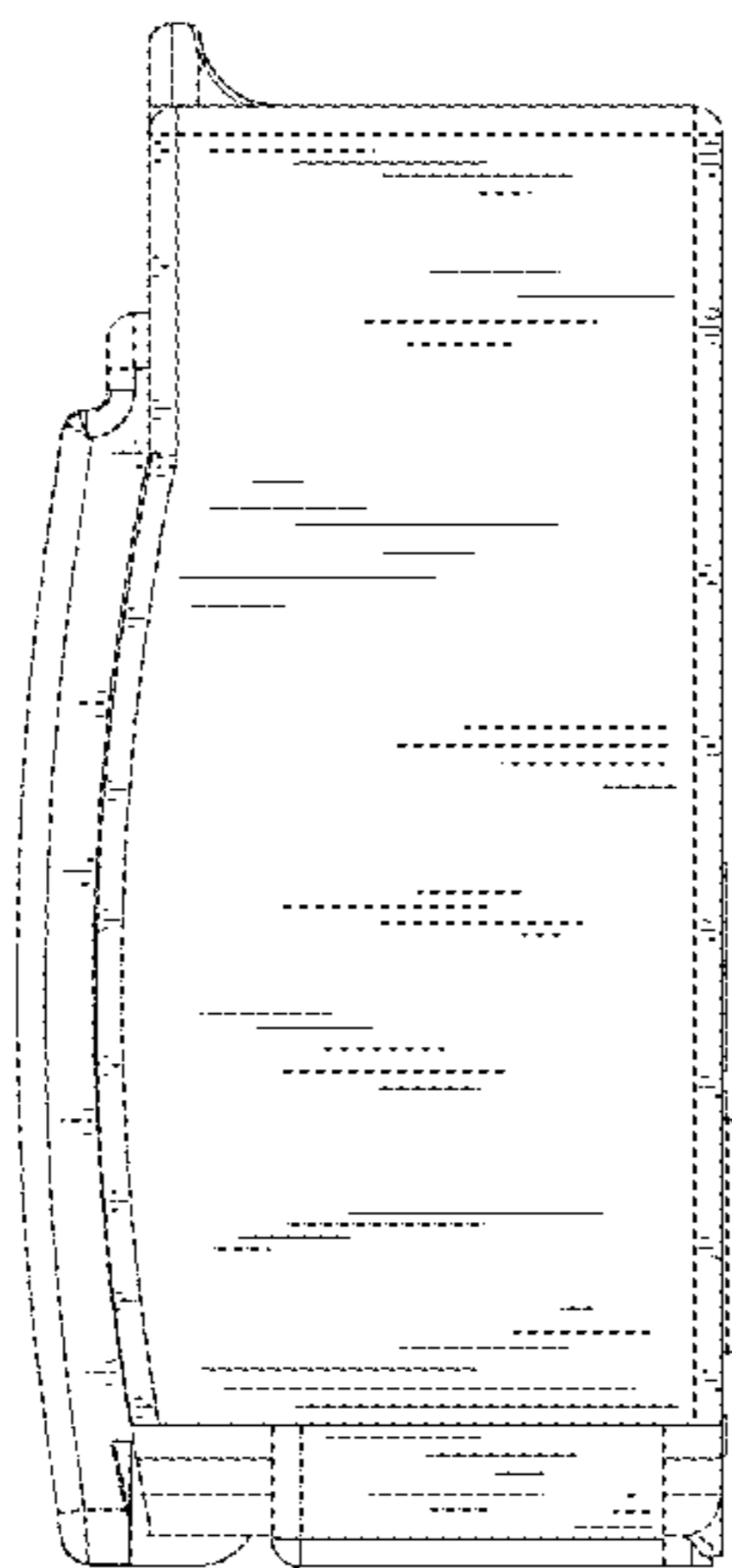

FIG. 11

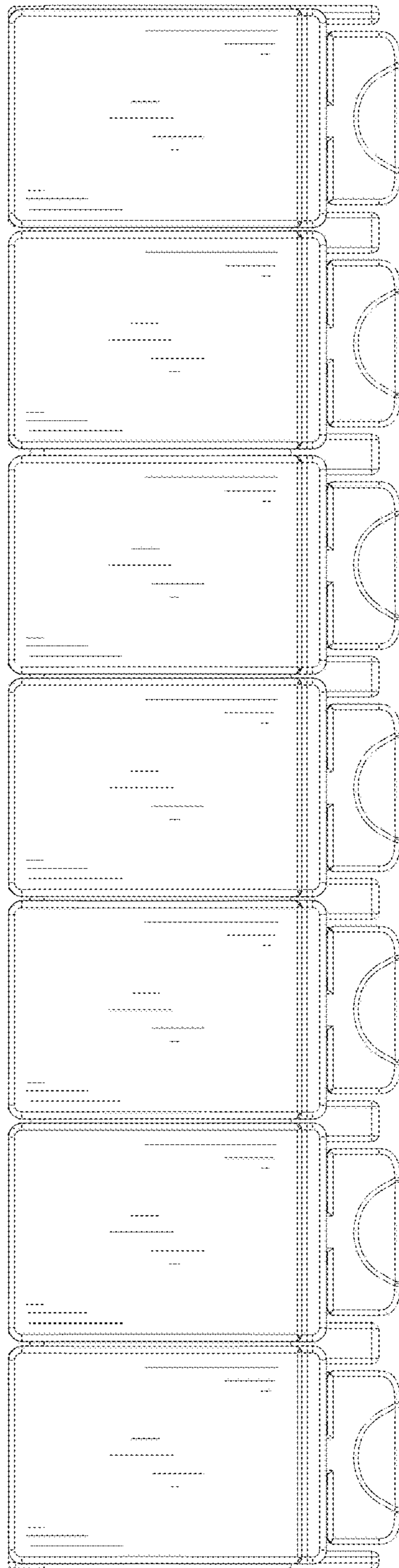

FIG. 13

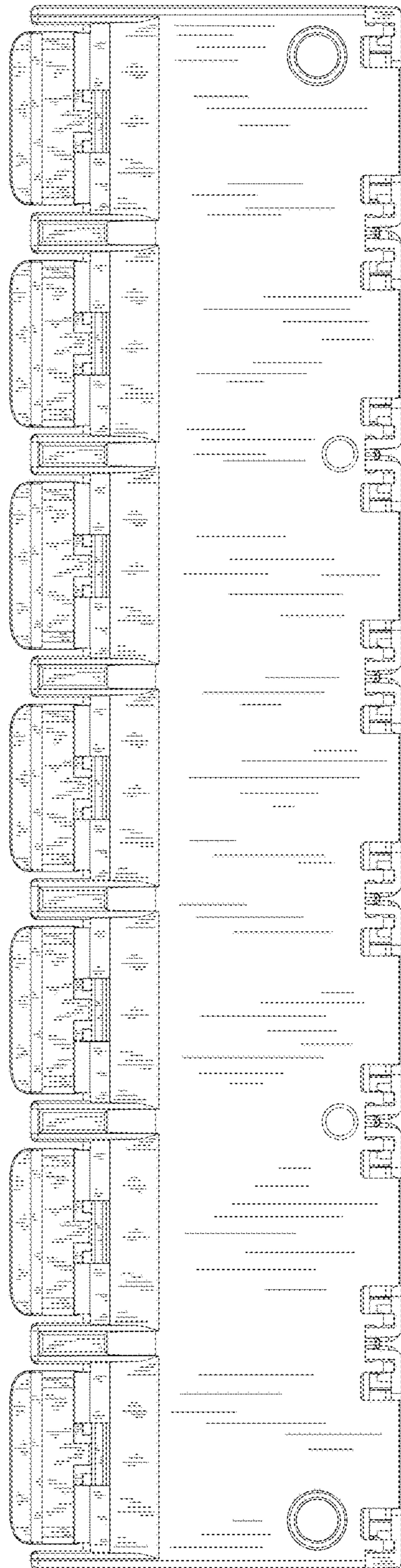

FIG. 14