



US00D831279S

(12) **United States Design Patent**
Troxell

(10) **Patent No.:** **US D831,279 S**

(45) **Date of Patent:** **** Oct. 16, 2018**

(54) **KNEEPAD WITH A SELECT-A-SIZE HOLDING STRAP**

D464,177 S 10/2002 Troxell
D551,352 S * 9/2007 Frangi D24/190
7,900,271 B2 * 3/2011 Sonner A41D 13/065
2/2.5
D687,154 S * 7/2013 Chen D24/190

(71) Applicant: **Southland Tile Tools & Accessories, Inc.**, Huntington Beach, CA (US)

* cited by examiner

(72) Inventor: **Ronald Troxell**, Huntington Beach, CA (US)

Primary Examiner — Randall H Gholson

(73) Assignee: **Southland Tile Tools & Accessories, Inc.**, Huntington Beach, CA (US)

(74) *Attorney, Agent, or Firm* — Klein, O'Neill & Singh, LLP

(**) Term: **15 Years**

(57) **CLAIM**

(21) Appl. No.: **29/588,400**

The ornamental design for a kneepad with a select-a-size holding strap, as shown and described.

(22) Filed: **Dec. 20, 2016**

(51) **LOC (11) Cl.** **29-02**

(52) **U.S. Cl.**
USPC **D29/121.1**

DESCRIPTION

(58) **Field of Classification Search**
USPC D29/10, 11, 100, 101.5, 121.1, 122;
D2/711, 713; 128/95.1, 96.1, 98.1, 846,
128/891; 602/67, 72, 73, 96, 108, 114;
2/2, 455; 450/38, 228, 267, 403, 405;
623/7; 604/352, 353, 395
CPC A41D 13/05; A41D 13/0525; A63B 71/08
See application file for complete search history.

FIG. 1 is a front elevational view showing my new design; FIG. 2 is a top plan view of FIG. 1; FIG. 3 is a bottom plan view of FIG. 1; FIG. 4 is a rear elevational view of FIG. 1; FIG. 5 is a left side view of FIG. 1; FIG. 6 is a right side view of FIG. 1; FIG. 7 is a front perspective view of the kneepad of the present invention with the single holding strap thereof wrapped around the kneepad in a position such as worn on a wearer, with an end portion of the strap cutoff for illustrative purposes only to show how the strap may be adjusted to fit; and, FIG. 8 is a partial front elevational view of a strap showing a second embodiment of the invention with the words "CUT TO SIZE" adjacent the cross-stitched sections to indicate to the wearer where the strap may be cut to fit. The broken lines shown in FIGS. 1 and 4-8 are for illustrative purposes only and form no part of the claimed design.

(56) **References Cited**

U.S. PATENT DOCUMENTS

2,785,407 A 3/1957 Reeder
D195,191 S 5/1963 Marvid
4,751,748 A 6/1988 Elkins
D322,146 S * 12/1991 Anderson D29/121.1
D343,256 S * 1/1994 Davis D29/121.1
D406,677 S 3/1999 Koschmann et al.
6,253,376 B1 7/2001 Ritter

1 Claim, 5 Drawing Sheets

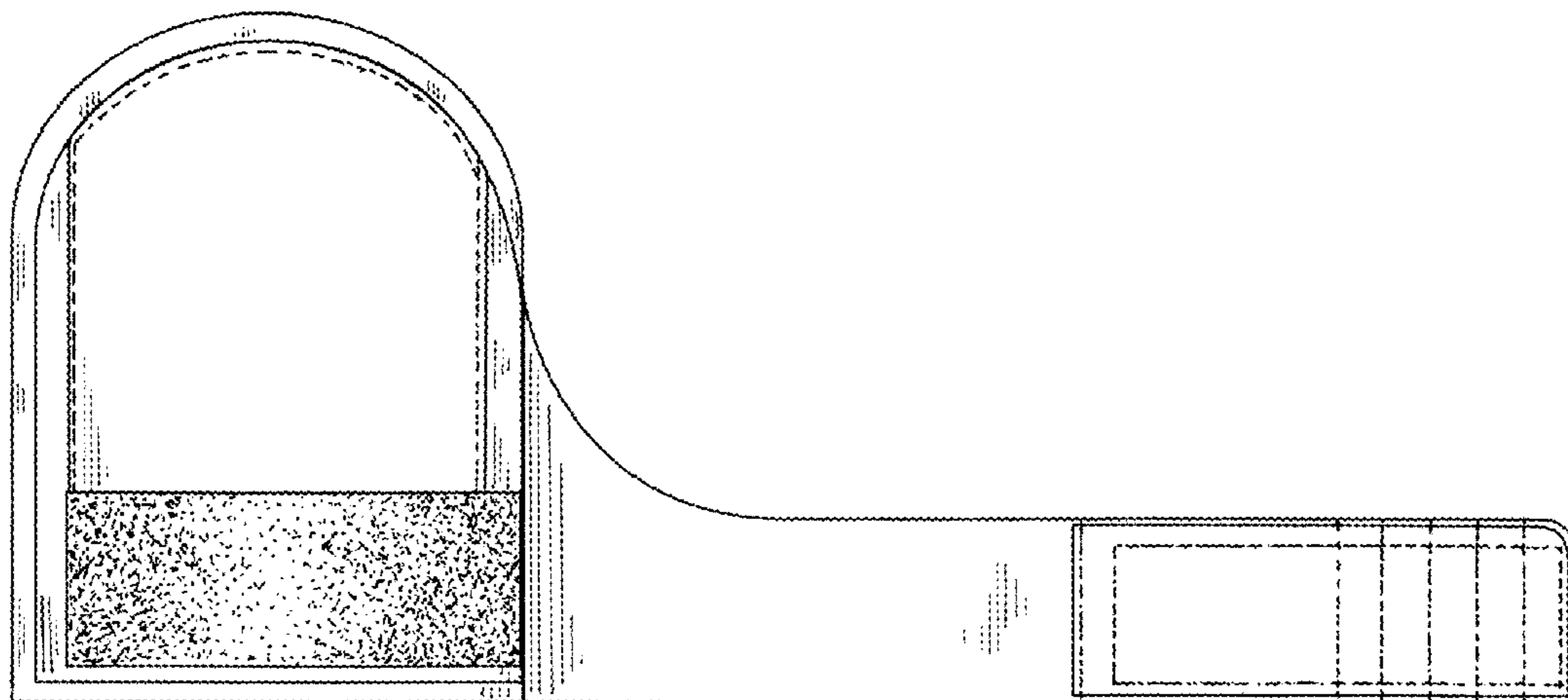

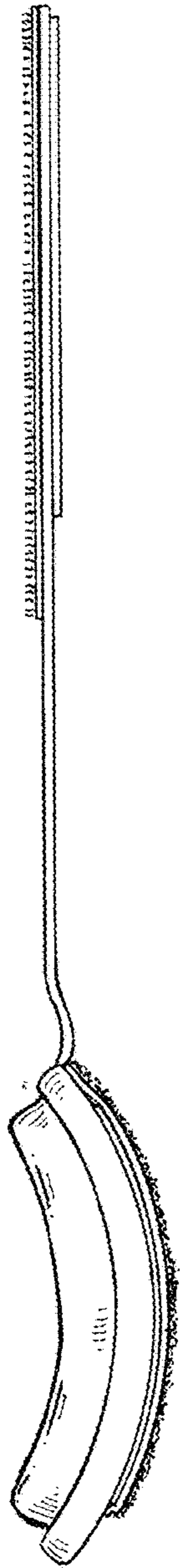

FIG. 2

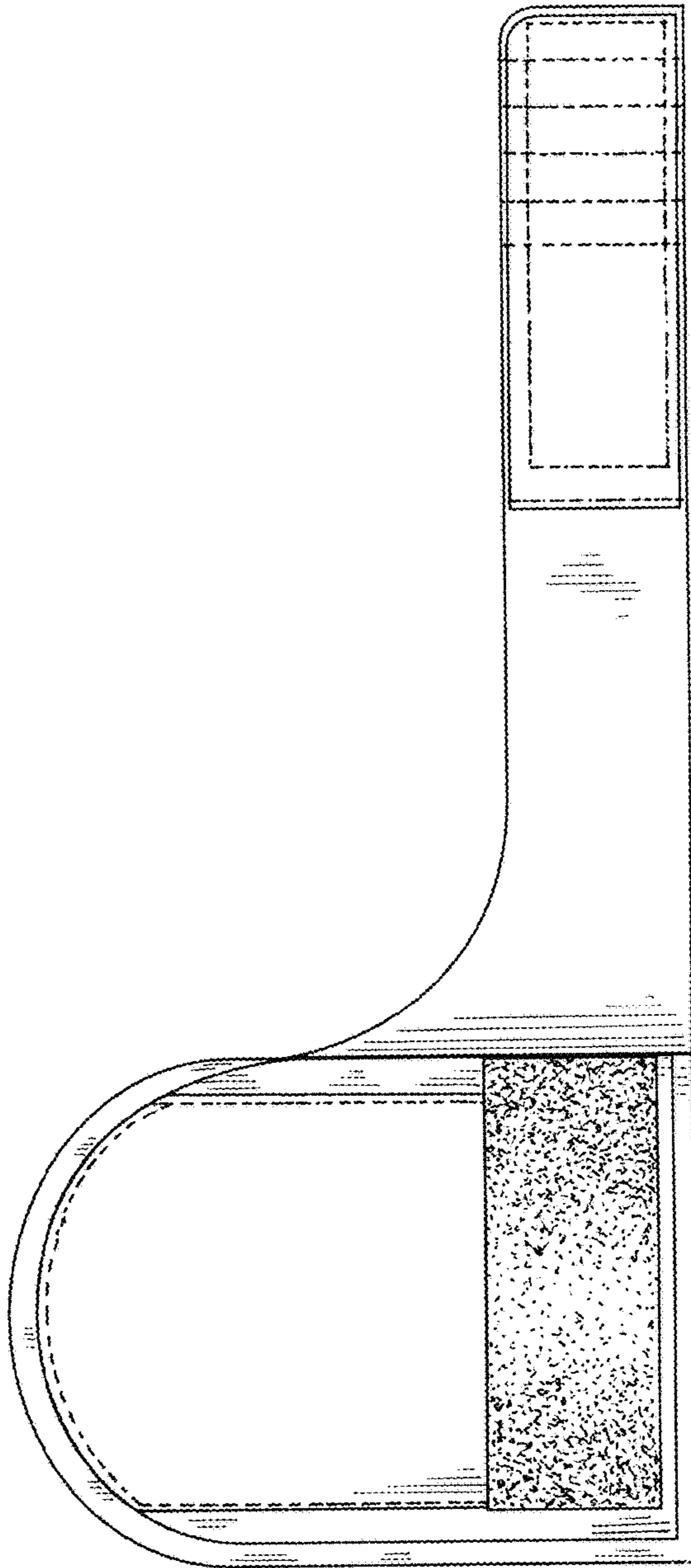

FIG. 1

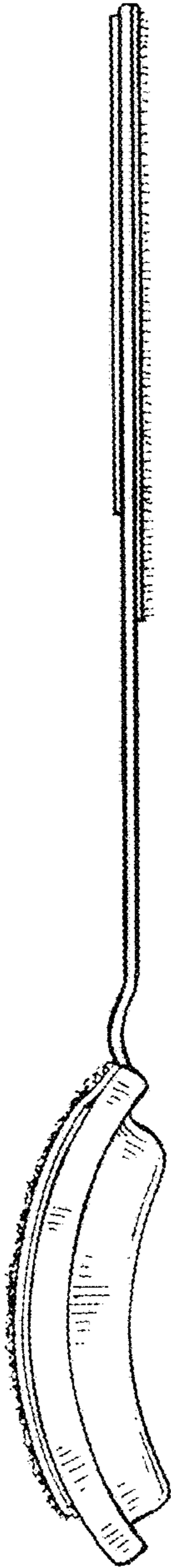

FIG. 3

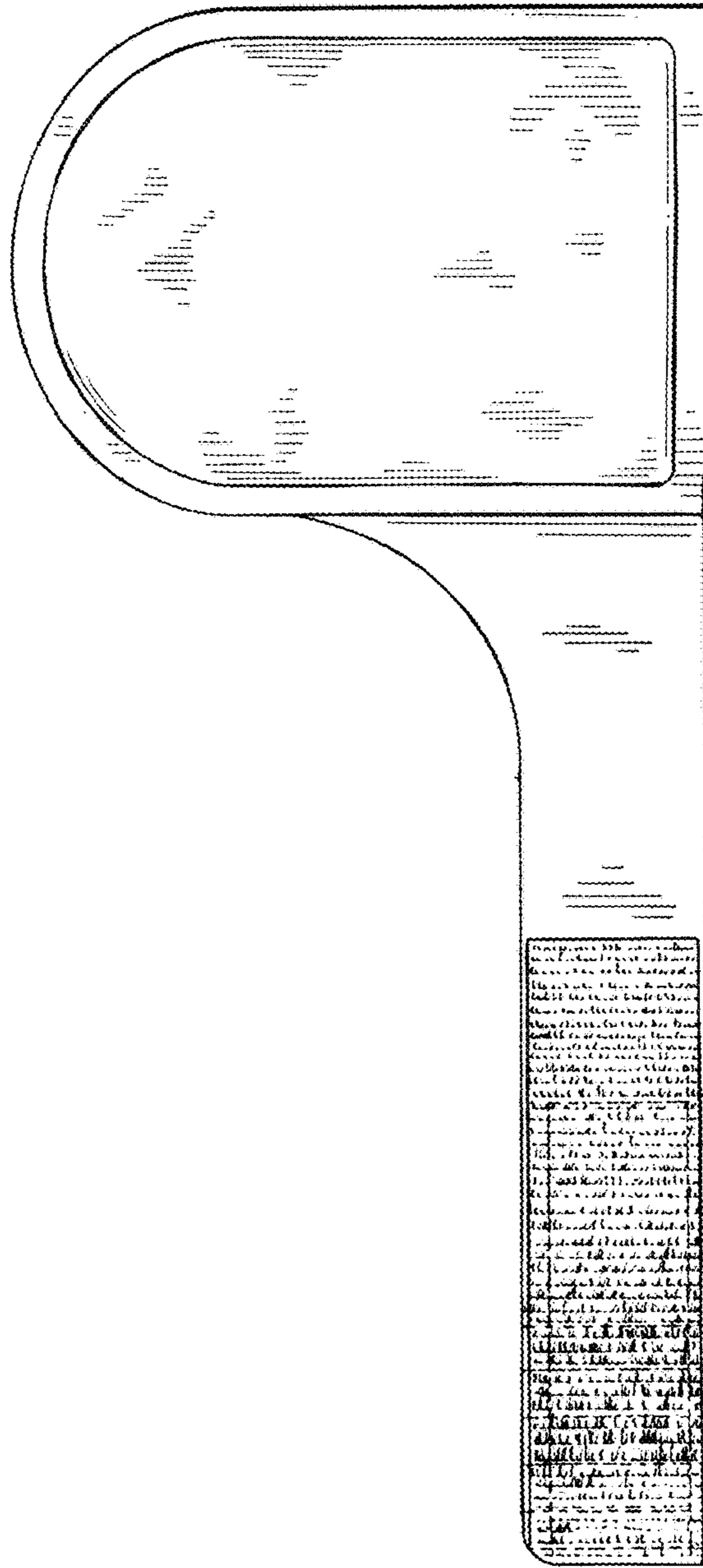

FIG. 4

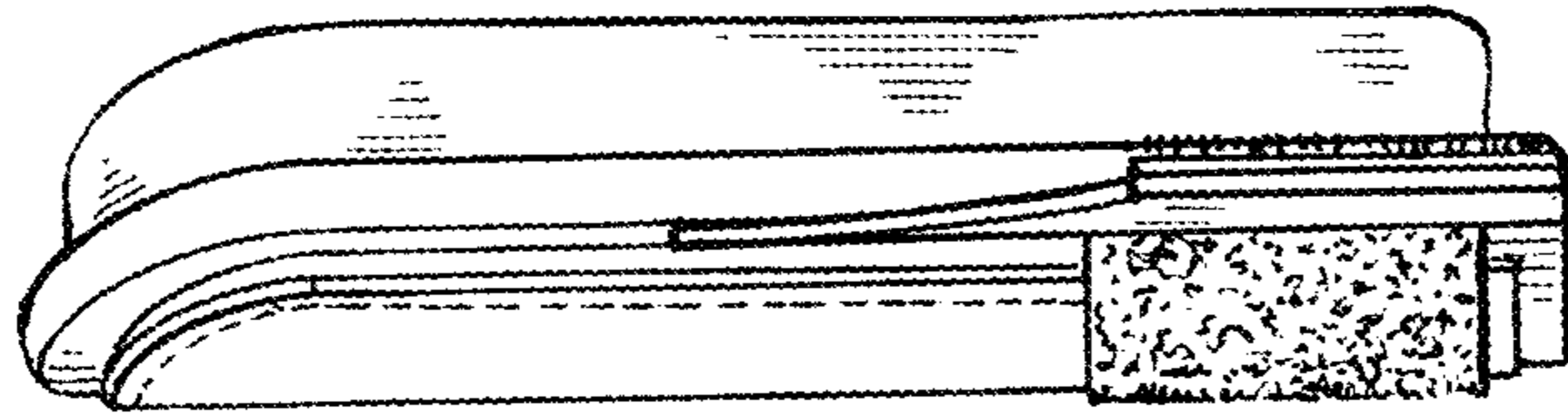

FIG. 6

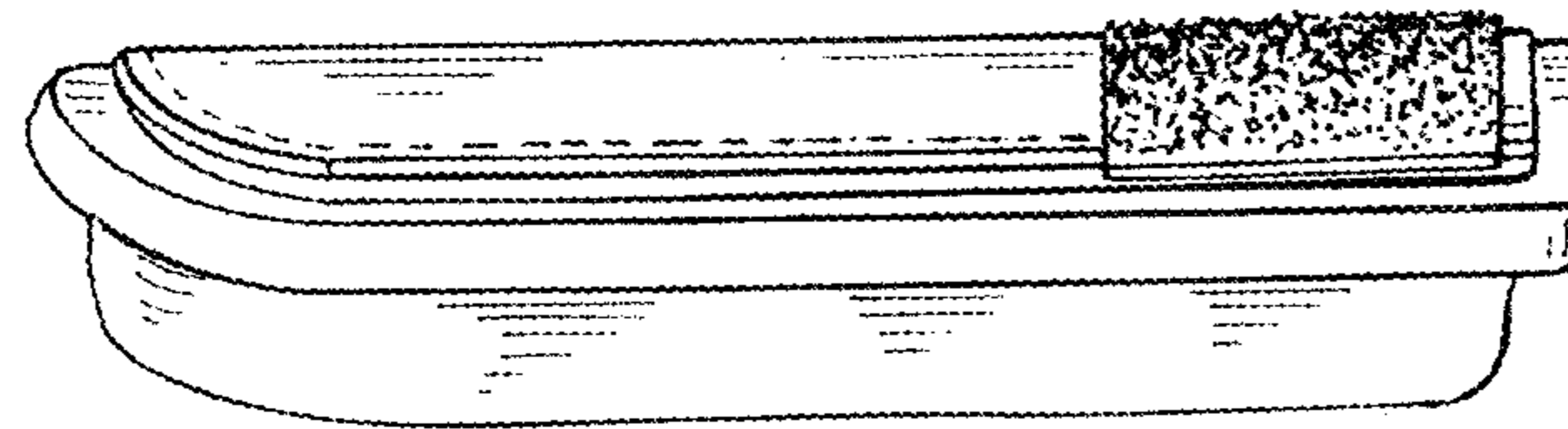

FIG. 5

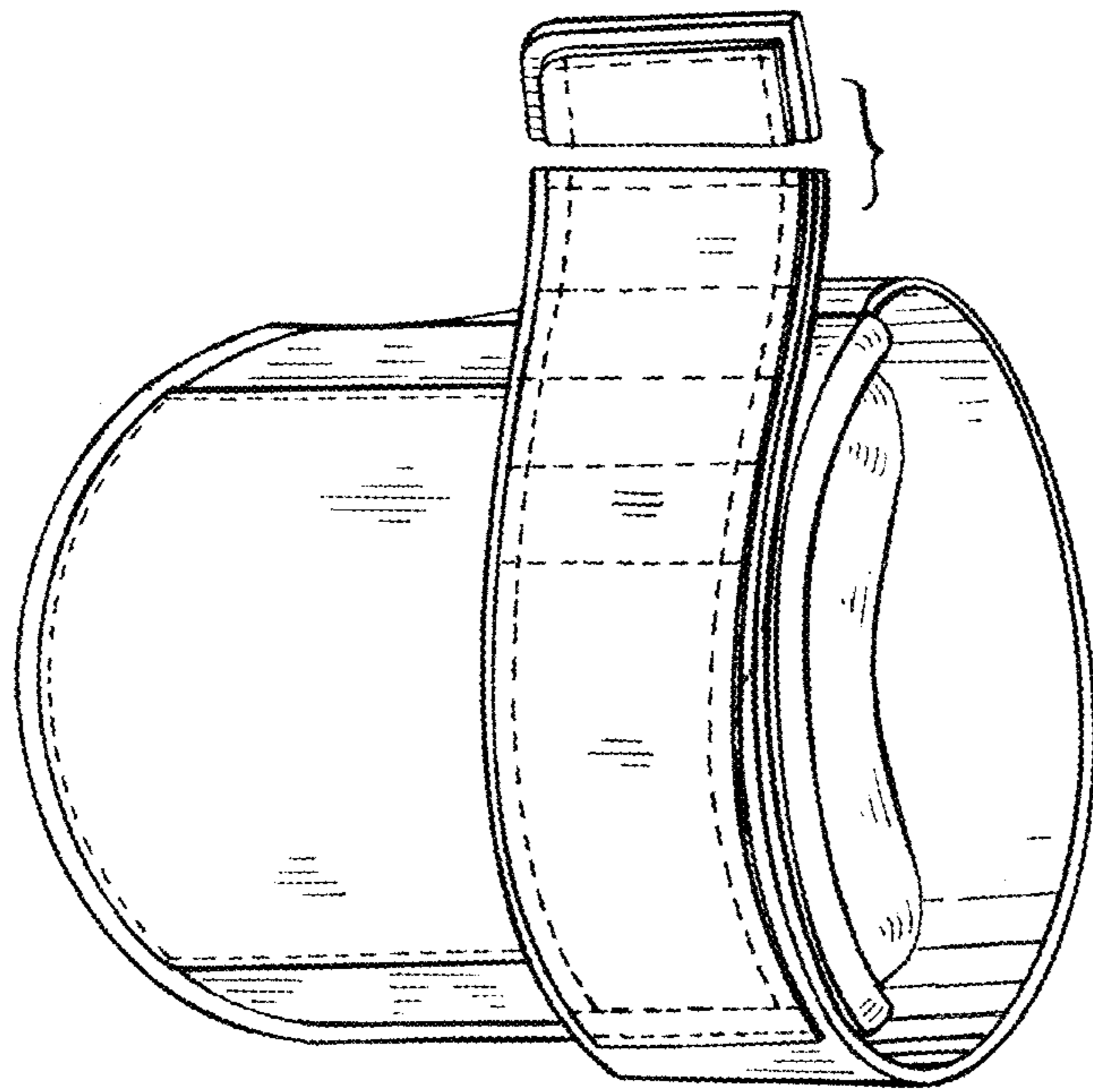

FIG. 7

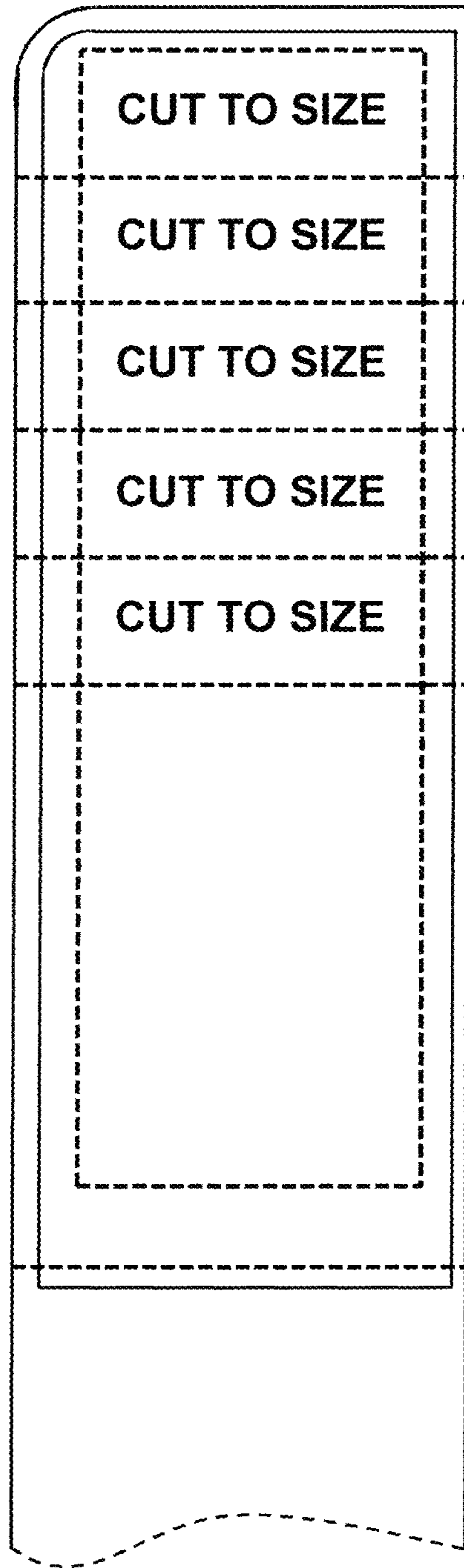

FIG. 8