



US00D831275S

(12) **United States Design Patent**
Maynard

(10) **Patent No.:** **US D831,275 S**
(45) **Date of Patent:** **** Oct. 16, 2018**

- (54) **COSMETICS CASE**
- (71) Applicant: **STORYBOOK COSMETICS, LLC**,
Omaha, NE (US)
- (72) Inventor: **Erin Maynard**, Omaha, NE (US)
- (73) Assignee: **Storybook Cosmetics, LLC**, Omaha,
NE (US)
- (**) Term: **15 Years**
- (21) Appl. No.: **29/599,317**
- (22) Filed: **Mar. 31, 2017**
- (51) **LOC (11) Cl.** **28-03**
- (52) **U.S. Cl.**
USPC **D28/83**
- (58) **Field of Classification Search**
USPC D28/76-78, 81-84; 132/294, 303-305,
132/314-318; D3/205, 901; 206/542,
206/581, 823; 264/630; D9/426, 430,
D9/432, 549
CPC A45D 40/00; A45D 40/18; A45D 40/0087;
A45D 40/222; A45D 33/00; A45D
33/006; A45D 33/025; A45D 2040/225;
A45D 2034/007; A45D 33/008; A45D
33/003; A45D 33/18; A45D 33/16
See application file for complete search history.

(56) **References Cited**

U.S. PATENT DOCUMENTS

- 1,694,702 A * 12/1928 Deitel A45C 11/24
132/294
- 1,715,820 A * 6/1929 Deitel A45D 33/006
132/294
- 1,788,189 A * 1/1931 Deitel A45D 33/26
132/294
- 2,465,946 A * 3/1949 Velez A45D 33/26
132/315

- D212,401 S * 10/1968 Sanford D3/275
- D255,125 S * 5/1980 Hazama D18/7
- 4,848,542 A * 7/1989 Burnette A45D 42/14
132/316

(Continued)

FOREIGN PATENT DOCUMENTS

- JP D1141675 * 5/2002

OTHER PUBLICATIONS

Morphe palette, posted at yveschild.com by Christine, posted Dec. 31, 2015 © 2017 Yve'sChild, online, site visited Nov. 22, 2017. Available from Internet, URL: <http://www.yveschild.com/2015/12/stepping-it-up-makeup-geek-morphe-and.html>.*

(Continued)

Primary Examiner — Shannon W Morgan
Assistant Examiner — Altaira J Swangin
(74) *Attorney, Agent, or Firm* — Hovey Williams LLP

(57) **CLAIM**

The ornamental design for a cosmetics case, as shown.

DESCRIPTION

FIG. 1 is a perspective view of a cosmetics case of the present invention with its lid open.
FIG. 2 is another perspective view of the cosmetics case with its lid open.
FIG. 3 is a top plan view of the cosmetics case with its lid open.
FIG. 4 is a side elevational view of the cosmetics case with its lid open.
FIG. 5 is a bottom view of the cosmetics case with its lid open.
FIG. 6 is a front elevational view of the cosmetics case with its lid open.
FIG. 7 is a rear elevational view of the cosmetics case with its lid open; and,
FIG. 8 is a perspective view of the cosmetics case with its lid closed.

1 Claim, 3 Drawing Sheets

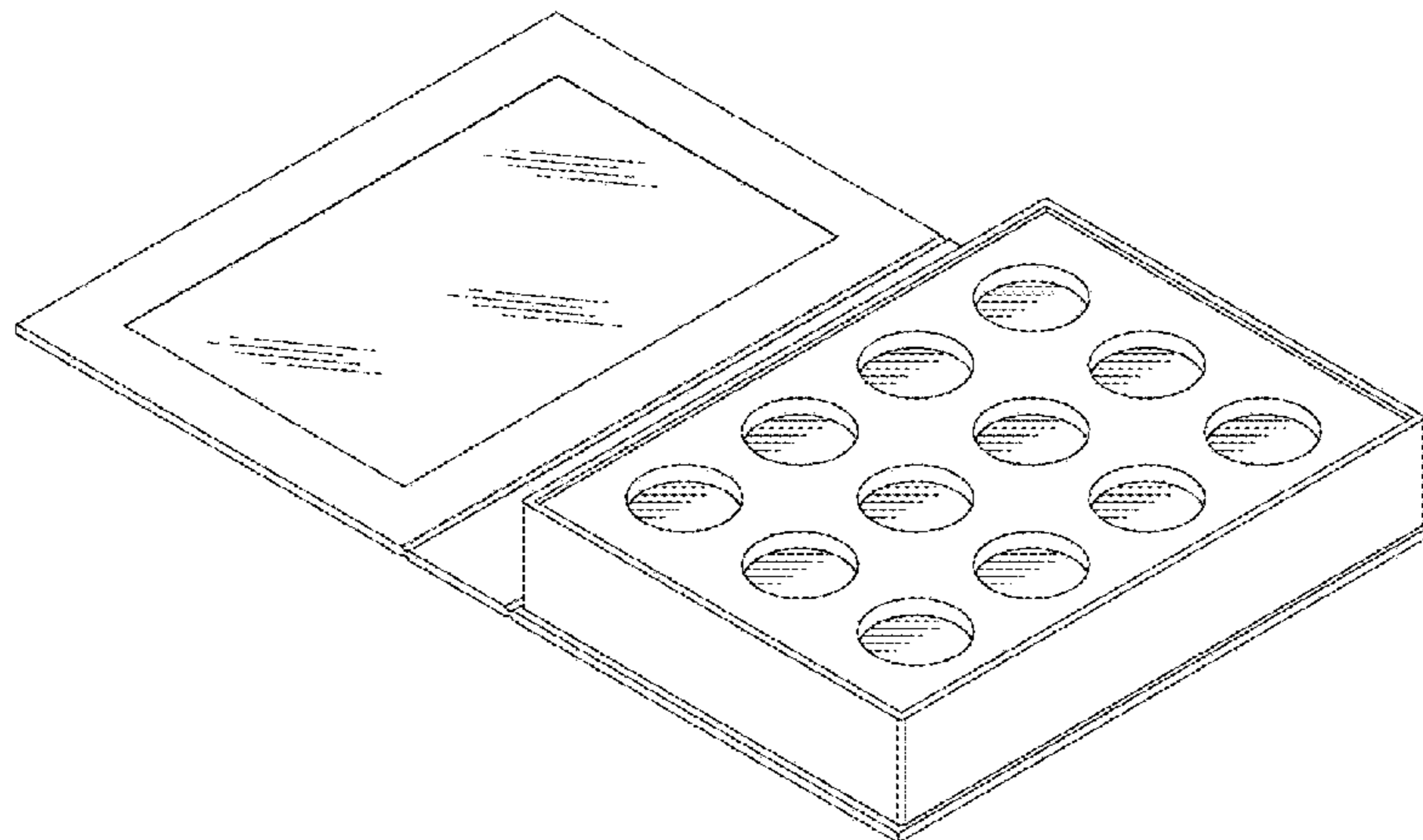

(56)

References Cited

U.S. PATENT DOCUMENTS

D443,393 S * 6/2001 Goswell D28/83
 D452,938 S * 1/2002 Lai D27/189
 D457,687 S * 5/2002 Millar D28/77
 D471,322 S * 3/2003 Lai D28/83
 D471,323 S * 3/2003 Lai D28/83
 D472,676 S * 4/2003 Lai D28/79
 D477,895 S * 7/2003 Goswell D28/83
 D478,192 S * 8/2003 Lai D28/83
 D479,630 S * 9/2003 Lai D28/83
 D479,895 S * 9/2003 Lai D28/83
 D480,180 S * 9/2003 Lai D28/83
 D480,837 S * 10/2003 Liu D28/83
 D493,919 S * 8/2004 Beilman D28/77
 D505,518 S * 5/2005 Benjamin D28/83
 D534,318 S * 12/2006 Ditrichstein D28/78
 D542,475 S * 5/2007 Martinez D28/83
 D554,294 S * 10/2007 Thorpe D28/83
 D564,707 S * 3/2008 Barresi D28/83
 D583,997 S * 12/2008 Thorpe D28/83
 D594,599 S * 6/2009 Thorpe D28/83
 D597,256 S * 7/2009 Liden D28/83
 D603,564 S * 11/2009 Liden D28/83
 D631,205 S * 1/2011 Lai D28/83
 D631,609 S * 1/2011 Lai D28/83
 D632,015 S * 2/2011 Lai D28/83
 D641,933 S * 7/2011 Chen D28/83
 D642,743 S * 8/2011 Shteyssel D28/83
 D709,651 S * 7/2014 Gaito D28/83
 D718,499 S * 11/2014 Pourmehr D28/83
 D722,724 S * 2/2015 Guor D28/83
 D790,134 S * 6/2017 Shteyssel D28/64.3

D806,532 S * 1/2018 Richmond D9/420
 2006/0027481 A1 * 2/2006 Gelardi A45D 33/008
 206/581
 2008/0245383 A1 * 10/2008 Tomandl A45D 33/008
 132/200
 2009/0095316 A1 * 4/2009 Gensch A45D 40/18
 132/317
 2009/0166247 A1 * 7/2009 Gindi A45D 33/008
 206/581
 2010/0132734 A1 * 6/2010 Mills A45D 40/24
 132/294
 2011/0155629 A1 * 6/2011 Debauge A45D 19/00
 206/581
 2014/0299151 A1 * 10/2014 Stroud A45D 33/008
 132/315
 2014/0318568 A1 * 10/2014 Lopes A45D 33/006
 132/286

OTHER PUBLICATIONS

Z palette, posted at bloglovin.com via temptalia.com by Christine Mielke, posted Dec. 13, 2013 © not listed, online, site visited Nov. 22, 2017. Available from Internet, URL: <https://www.bloglovin.com/blogs/temptalia-1752202/z-palette-large-pro-4u-small-dome-reviews-2047170643>.
 DIY 12 PCS Eyeshadow Palette Pan, posted at amazon.com by Leegoal, customer review posted Apr. 16, 2015 ©1996-2017 Amazon.com, Inc., online, site visited Nov. 27, 2017. Available from Internet, URL: <https://www.amazon.com/Leegoal-Magnetic-Cosmetics-Eyeshadow-Aluminum/dp/B00BBCVYR4?th=1>.

* cited by examiner

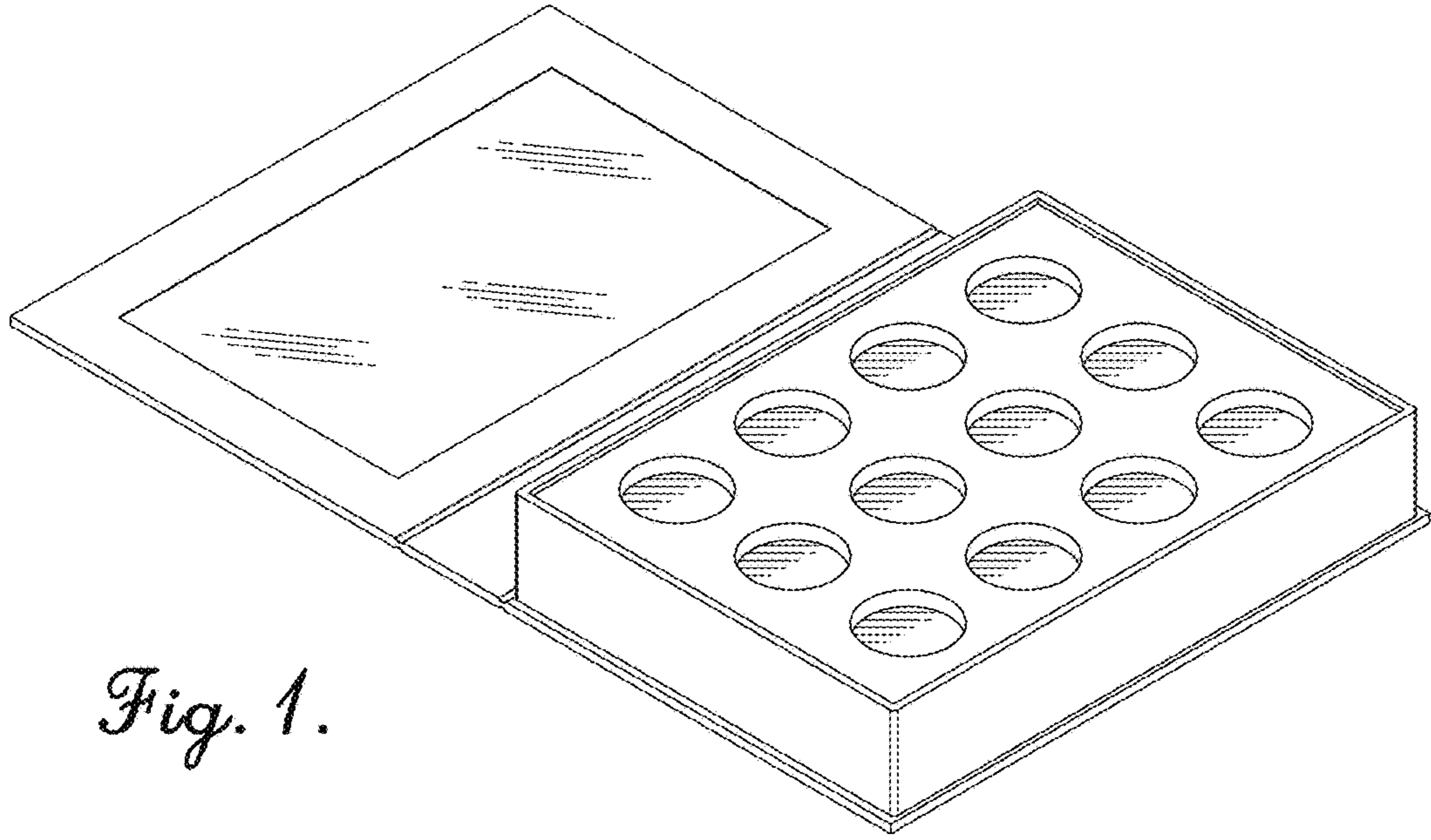

Fig. 1.

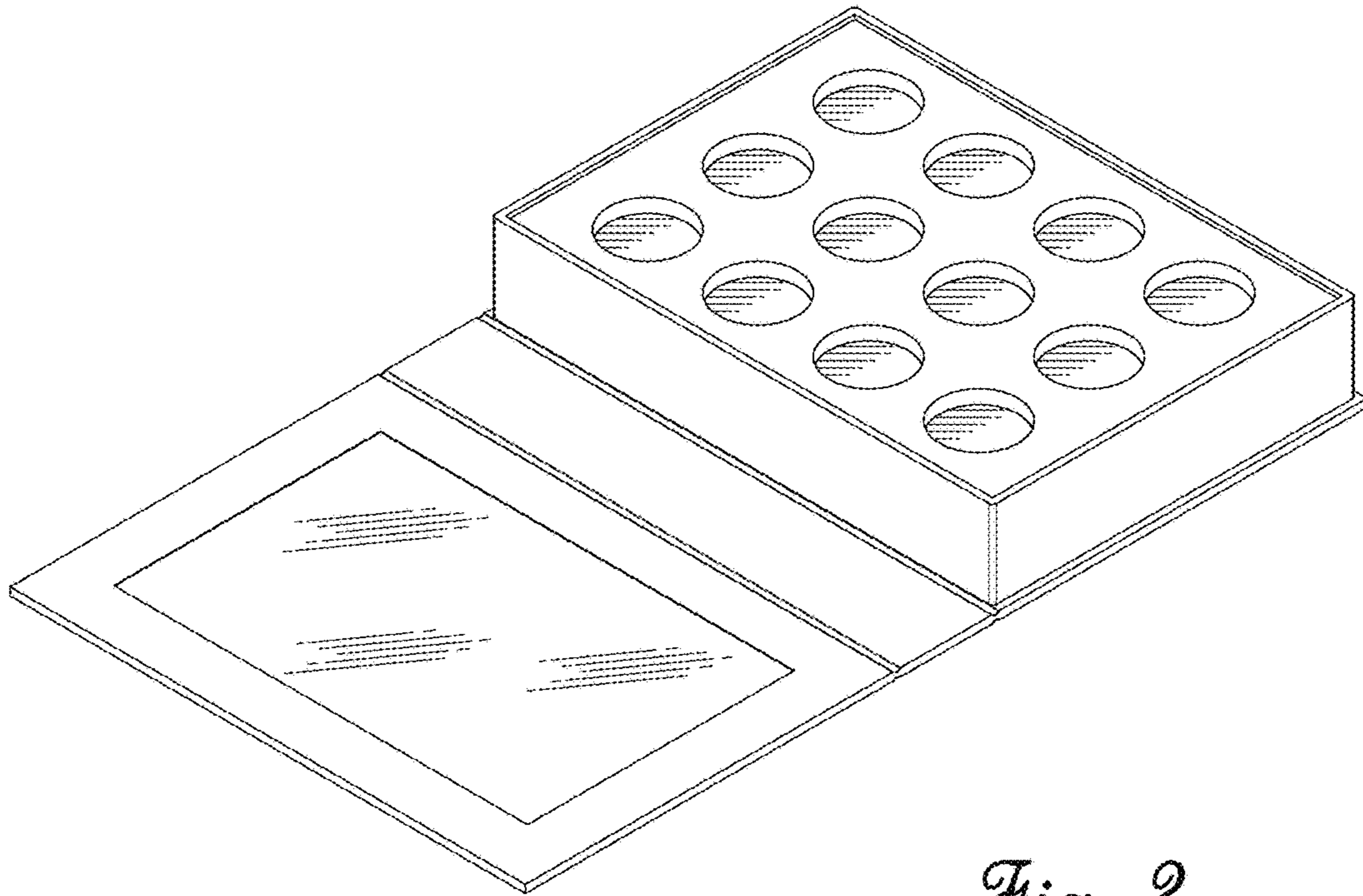

Fig. 2.

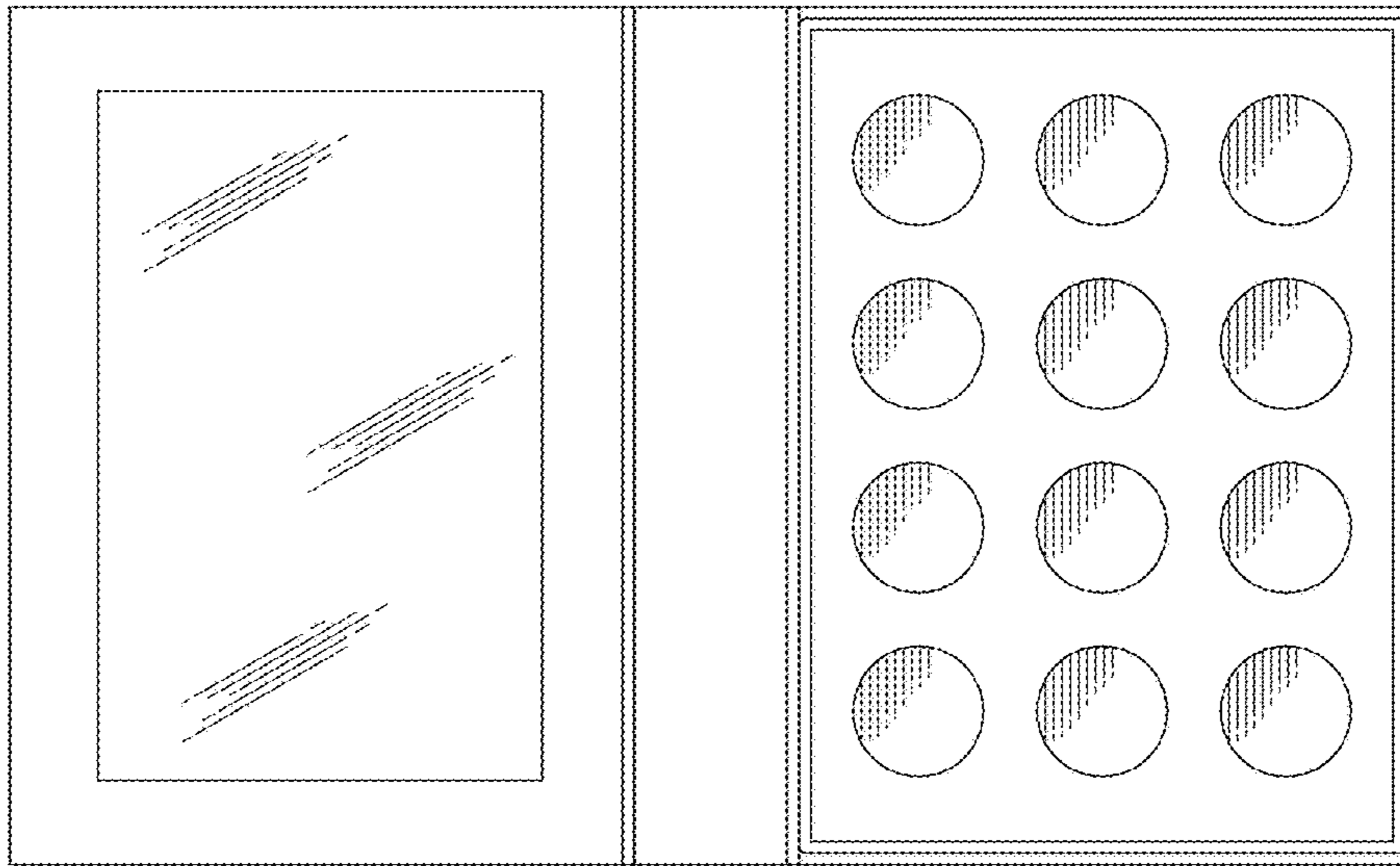

Fig. 3.



Fig. 4.

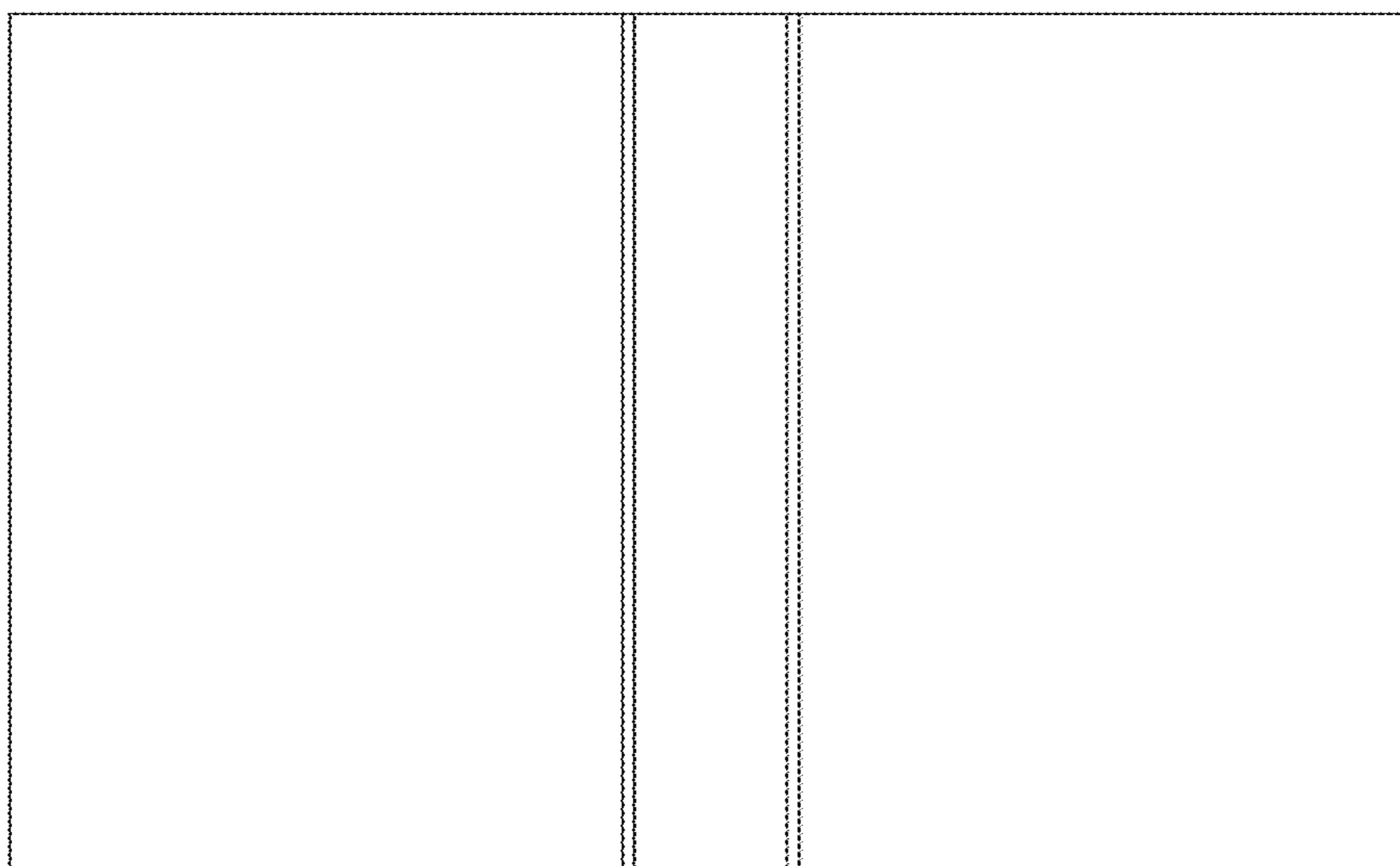

Fig. 5.

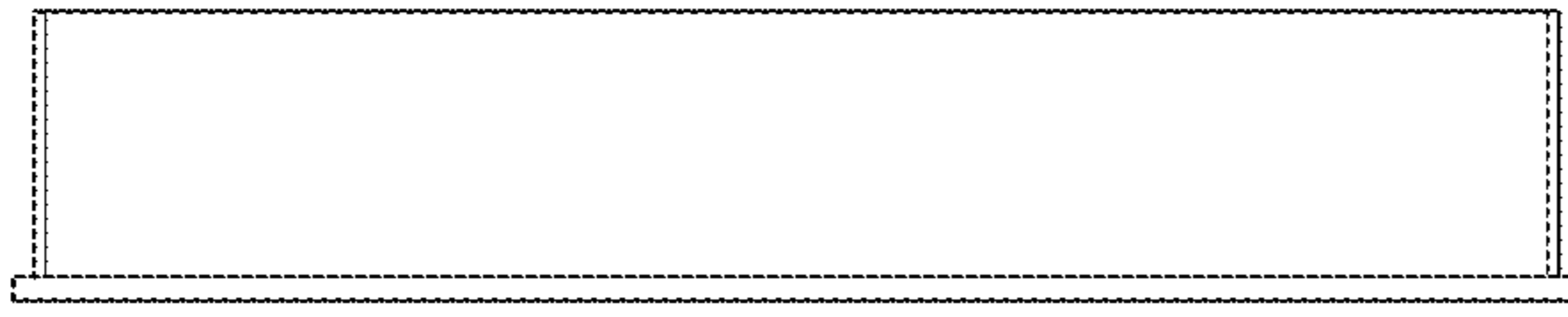

Fig. 6.

Fig. 7.

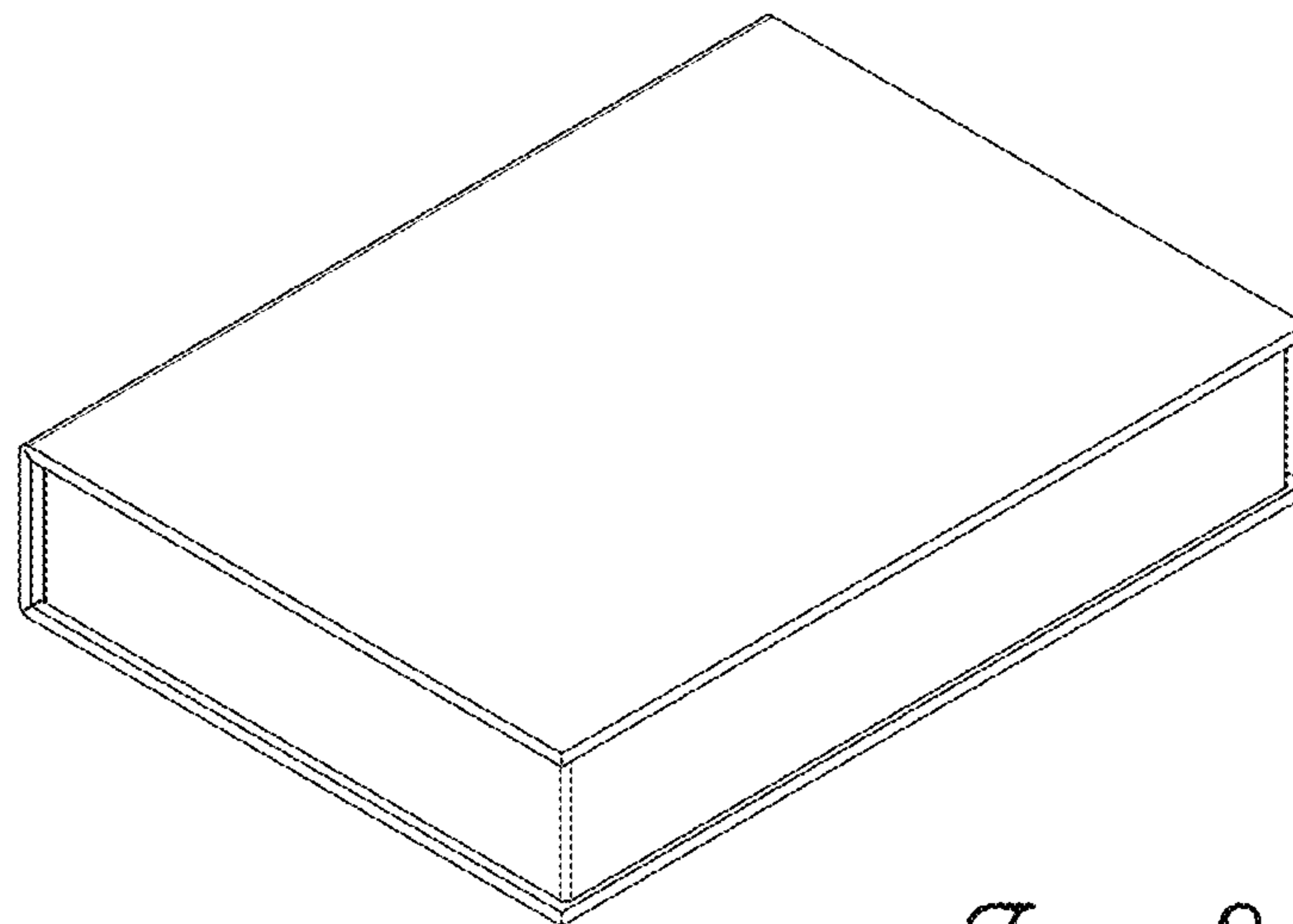
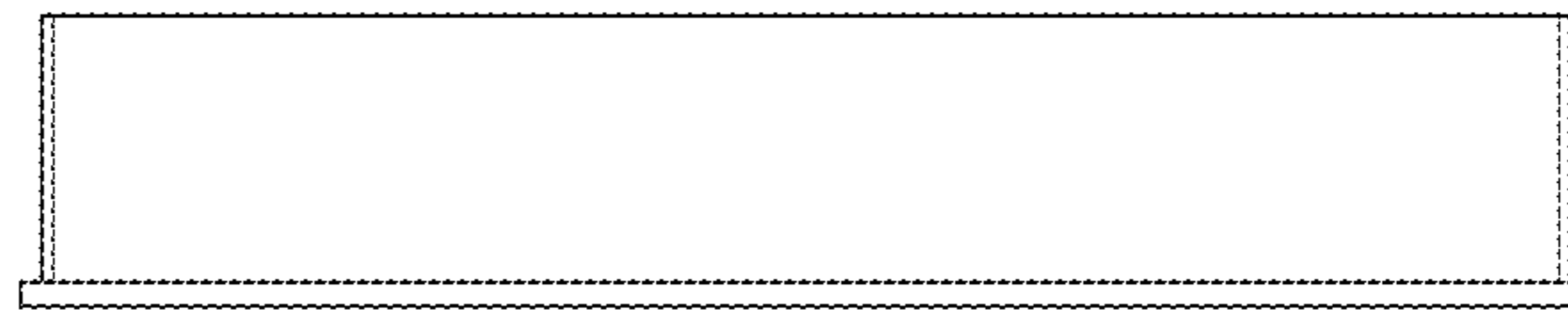

Fig. 8.