



US00D831239S

(12) **United States Design Patent** (10) **Patent No.:** **US D831,239 S**  
**Berends** (45) **Date of Patent:** **\*\* Oct. 16, 2018**

(54) **PIVOTABLE LED LIGHT BULB**

(56) **References Cited**

(71) Applicant: **Ningbo Qtop Import & Export Co., Ltd**, Yinzhou District, Ningbo (CN)

U.S. PATENT DOCUMENTS

(72) Inventor: **Boyd Edward Berends**, Zeeland, MI (US)

D478,682 S *	8/2003	Abry .....	D26/65
D735,903 S *	8/2015	Li .....	D26/2
D741,519 S *	10/2015	Wang .....	D26/2
D750,284 S *	2/2016	Dudik .....	D26/2
D753,322 S *	4/2016	Taylor .....	D26/2
D771,283 S *	11/2016	Ke .....	D26/2

(73) Assignee: **NINGBO QTOP IMPORT & EXPORT CO., LTD** (CN)

\* cited by examiner

(\*\*) Term: **15 Years**

*Primary Examiner* — Marcus Jackson

(21) Appl. No.: **29/621,920**

(74) *Attorney, Agent, or Firm* — The Watson IP Group, PLC; Jovan N. Jovanovic; Vladen M. Vasiljevic

(22) Filed: **Oct. 12, 2017**

(57) **CLAIM**

The ornamental design for a pivotable LED light bulb, as shown and described.

**Related U.S. Application Data**

**DESCRIPTION**

(63) Continuation of application No. 14/631,484, filed on Feb. 25, 2015, now abandoned.

FIG. 1 of the drawings is a front perspective view of the pivotable LED light bulb showing, in particular, the ornamental design thereof;

(51) **LOC (11) Cl.** ..... **26-04**

FIG. 2 of the drawings is a back perspective view thereof;

(52) **U.S. Cl.**

FIG. 3 of the drawings is a front elevational view thereof;

USPC ..... **D26/2**

FIG. 4 of the drawings is a back elevational view thereof;

(58) **Field of Classification Search**

FIG. 5 of the drawings is a first side elevational view thereof;

USPC ..... D26/1-4; 313/313, 315, 316, 317, 318, 313/493; 315/52, 53, 56, 57, 58

FIG. 6 of the drawings is a second side elevational view thereof;

CPC ..... H01R 5/00; H01R 13/46; H01R 13/514;

FIG. 7 of the drawings is a top plan view thereof; and,

H01R 31/048; H01R 31/02; H01J 5/00;

FIG. 8 of the drawings is a bottom plan view thereof.

H01J 5/16; H01J 15/00; H01J 5/48; H01J

5/50; H01J 19/54; F21V 5/00

The dashed lines show features that form no part of the claimed design.

See application file for complete search history.

**1 Claim, 7 Drawing Sheets**

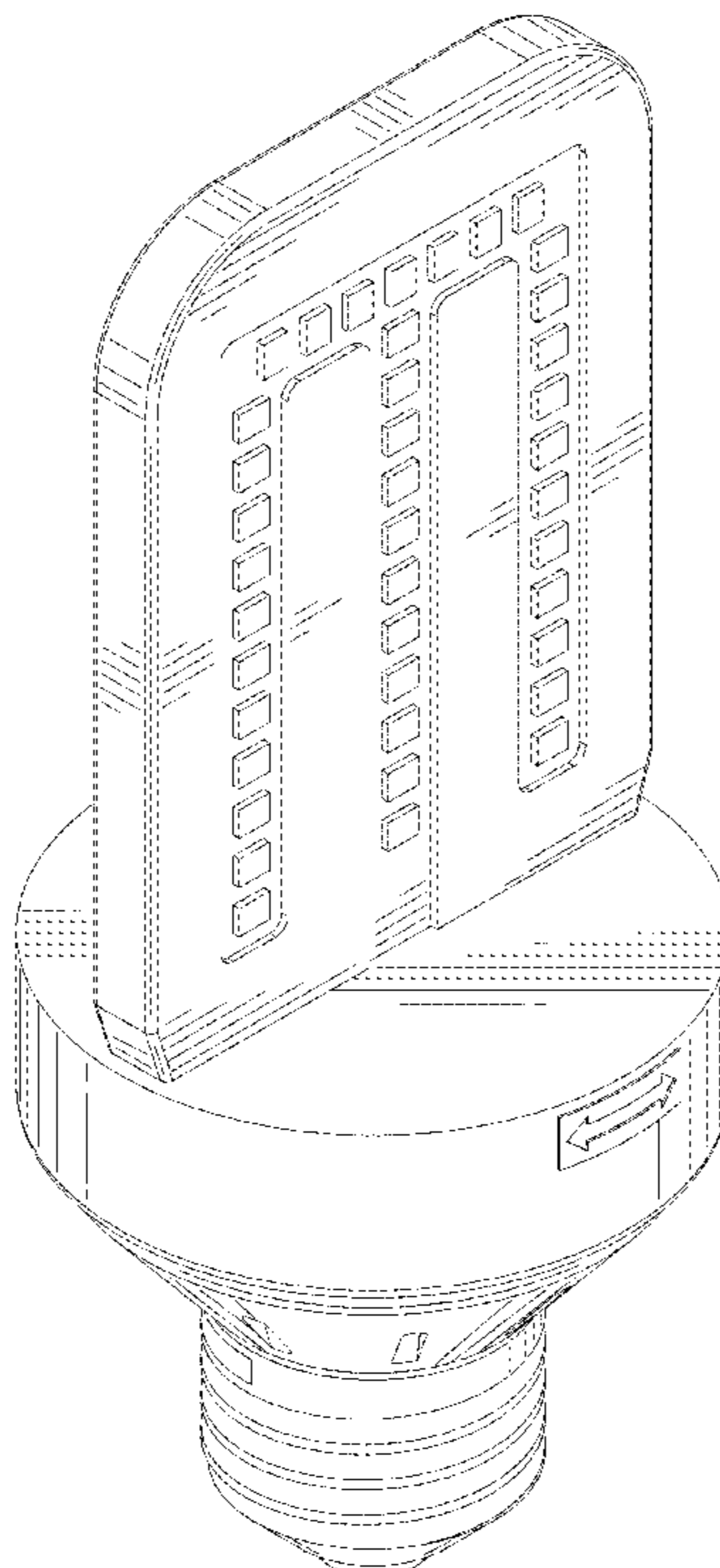

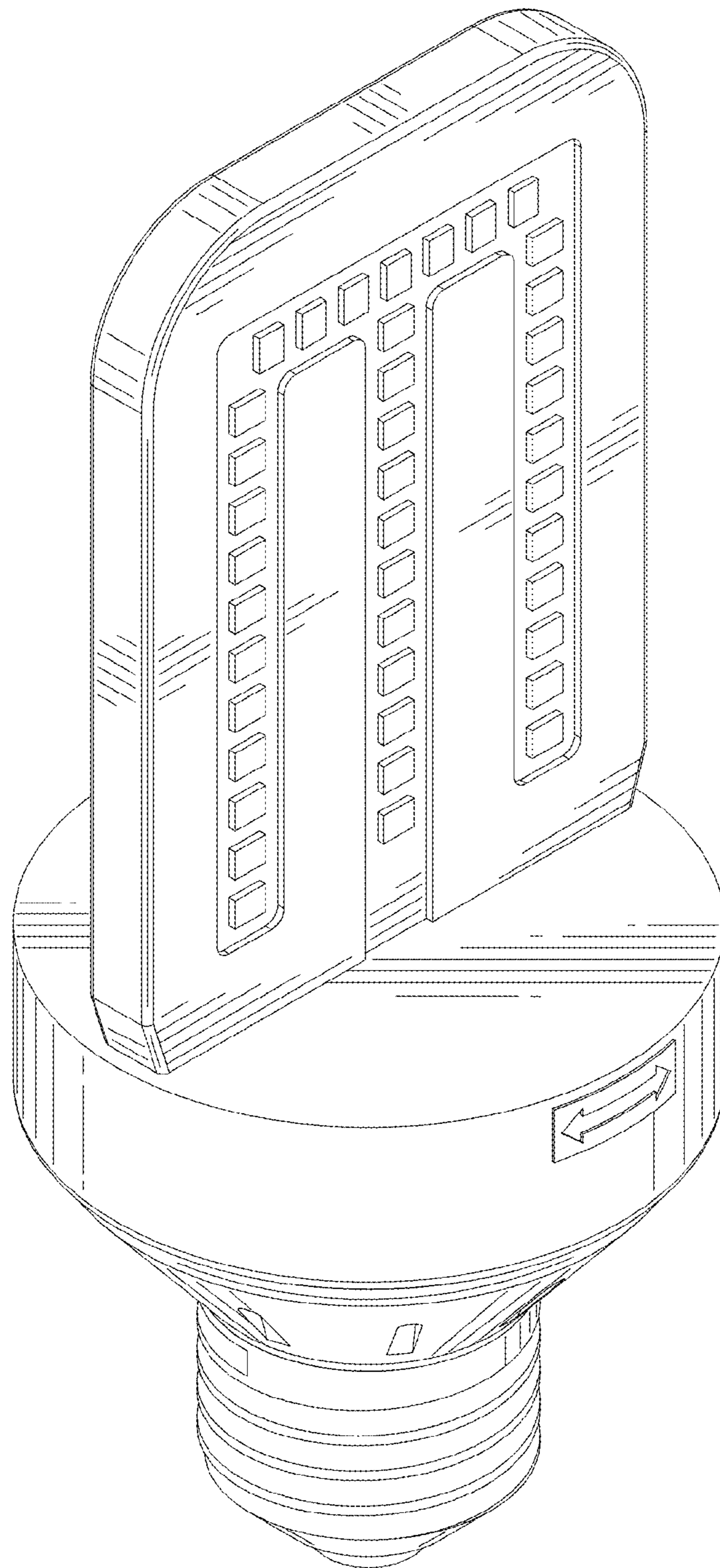

FIG. 1

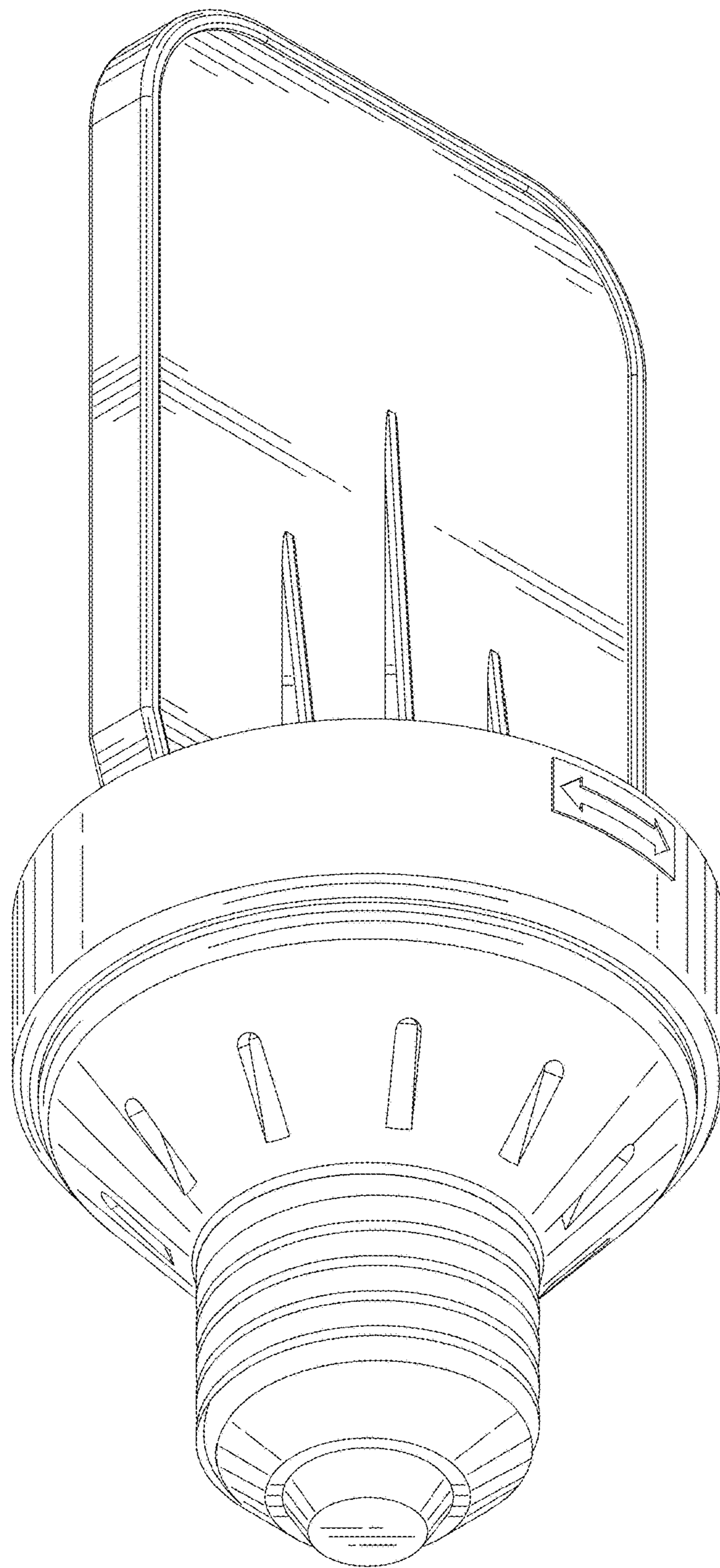

FIG. 2



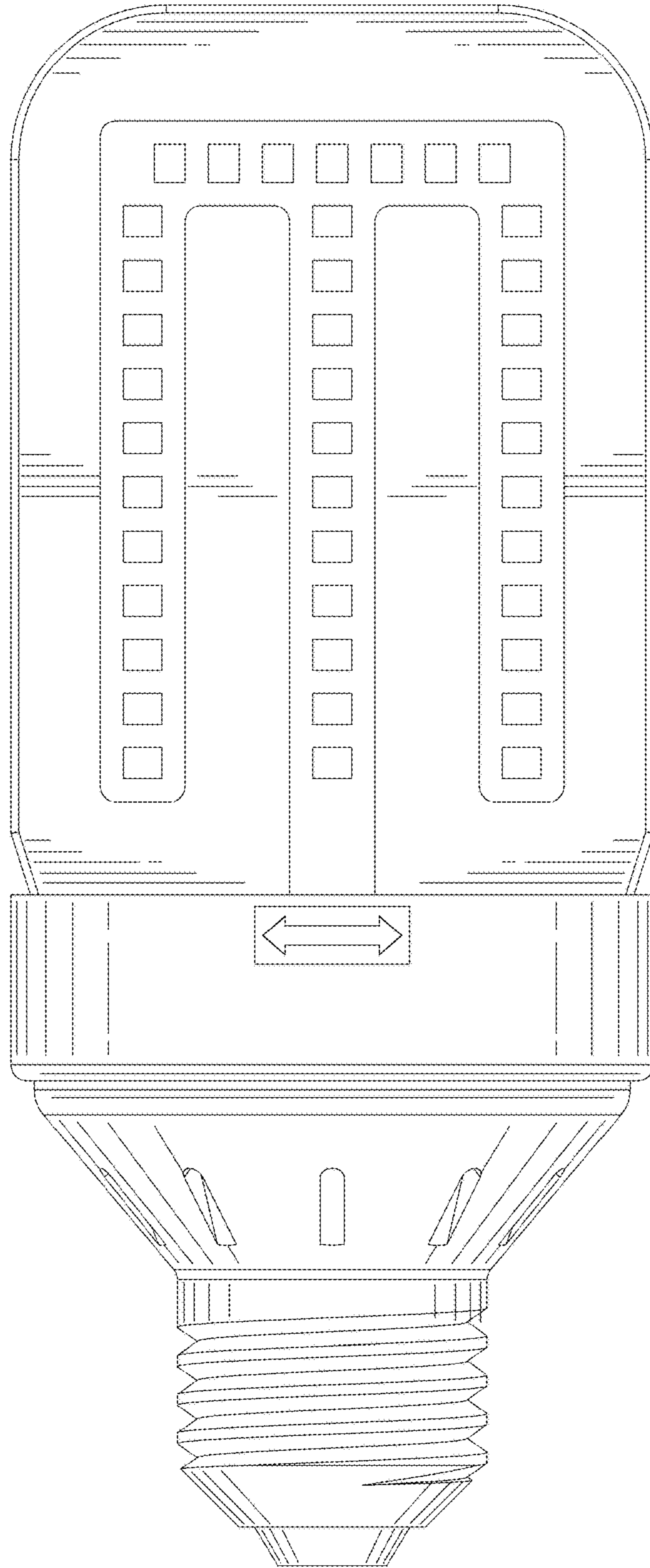

FIG. 3

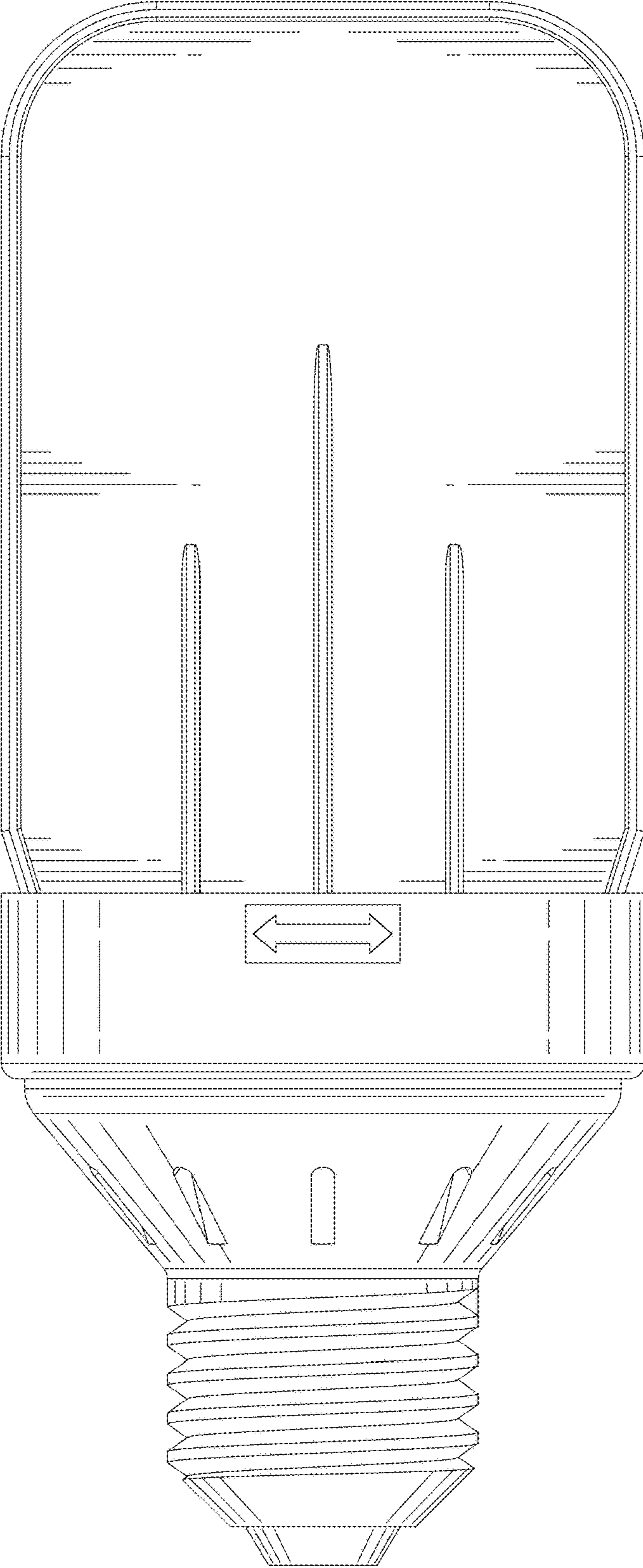

FIG. 4

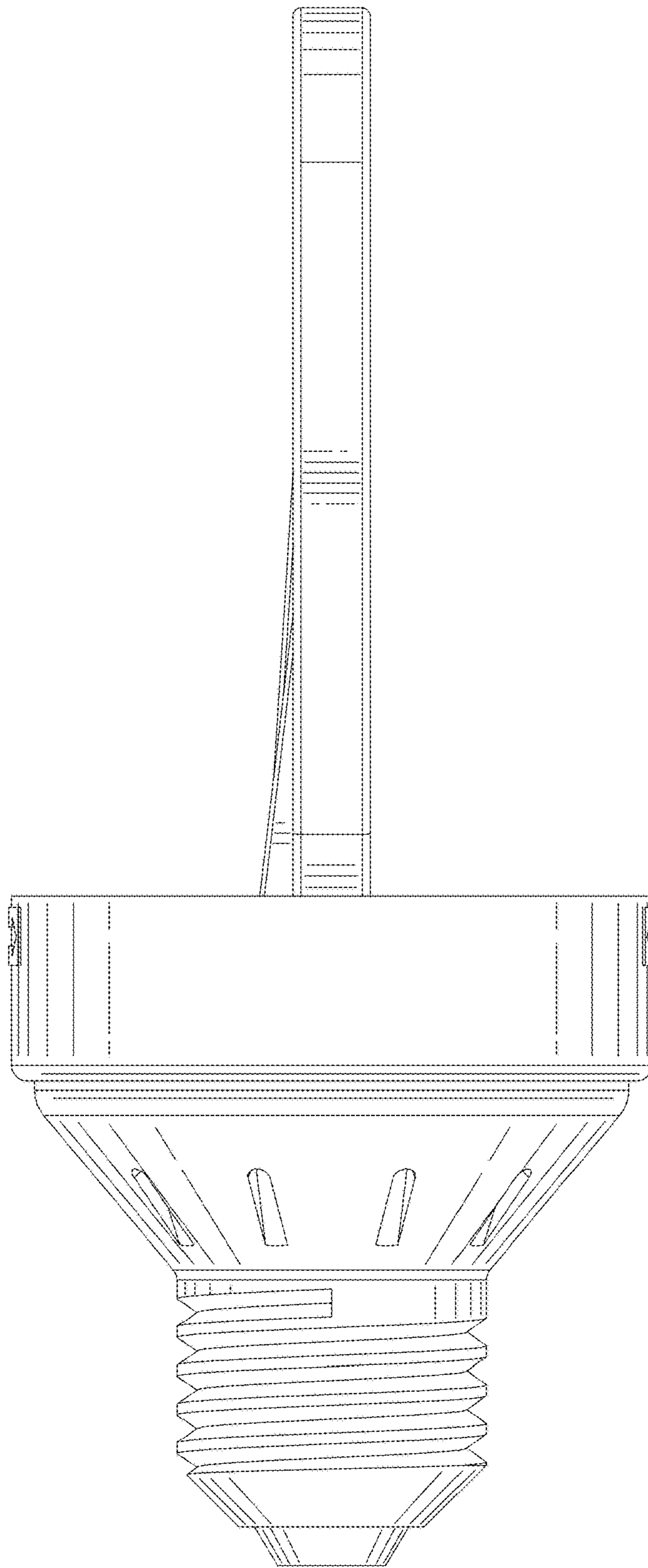

FIG. 5

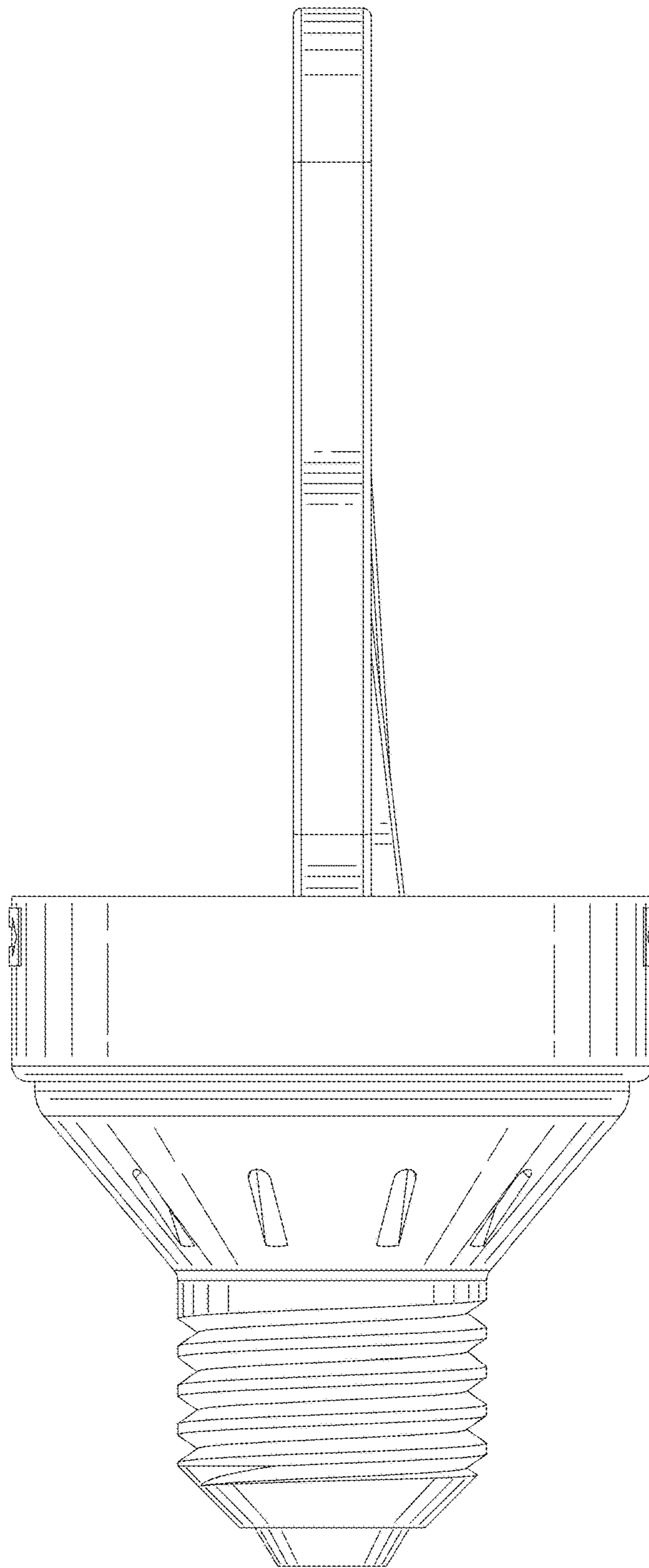

FIG. 6

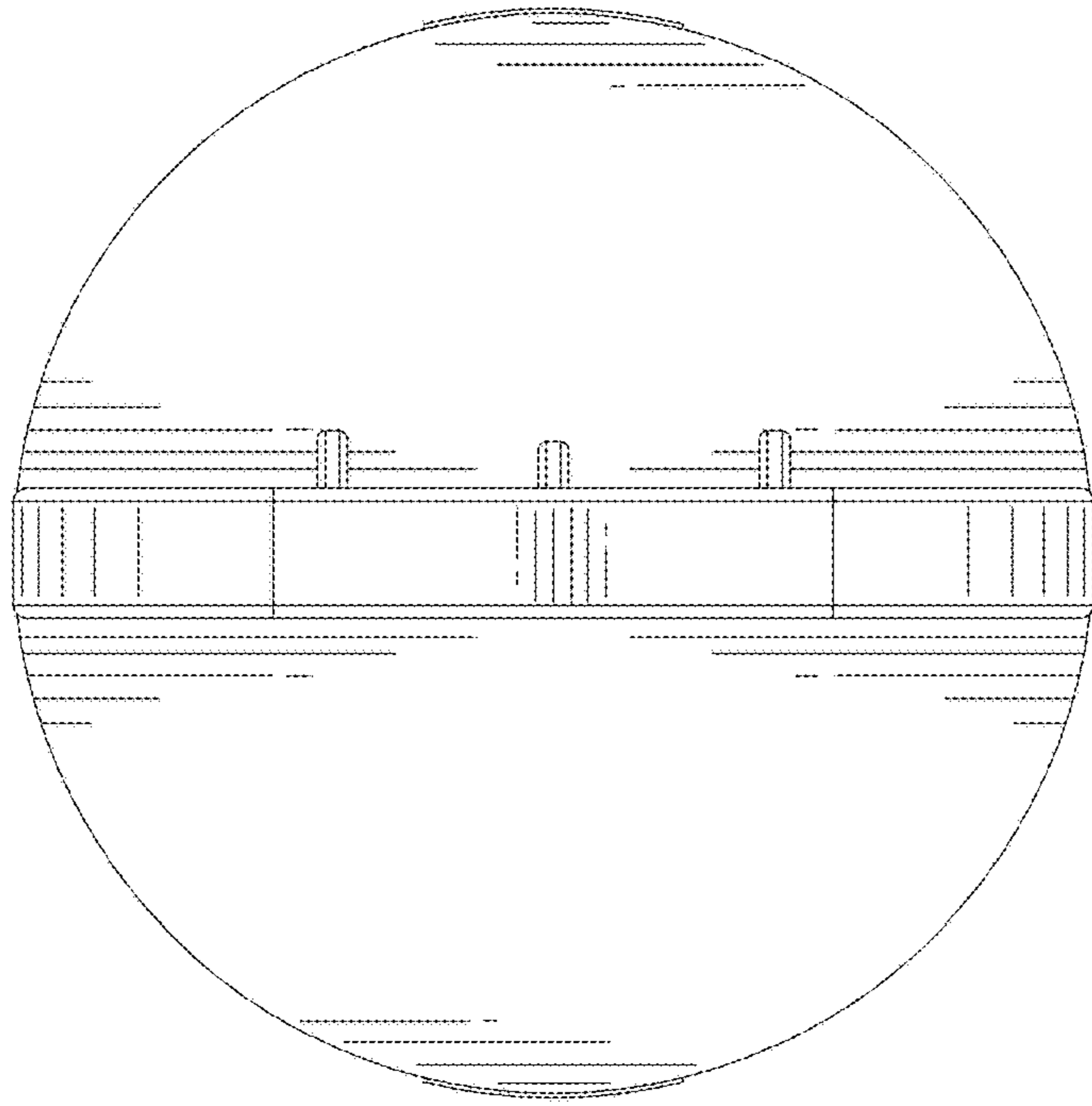

FIG. 7

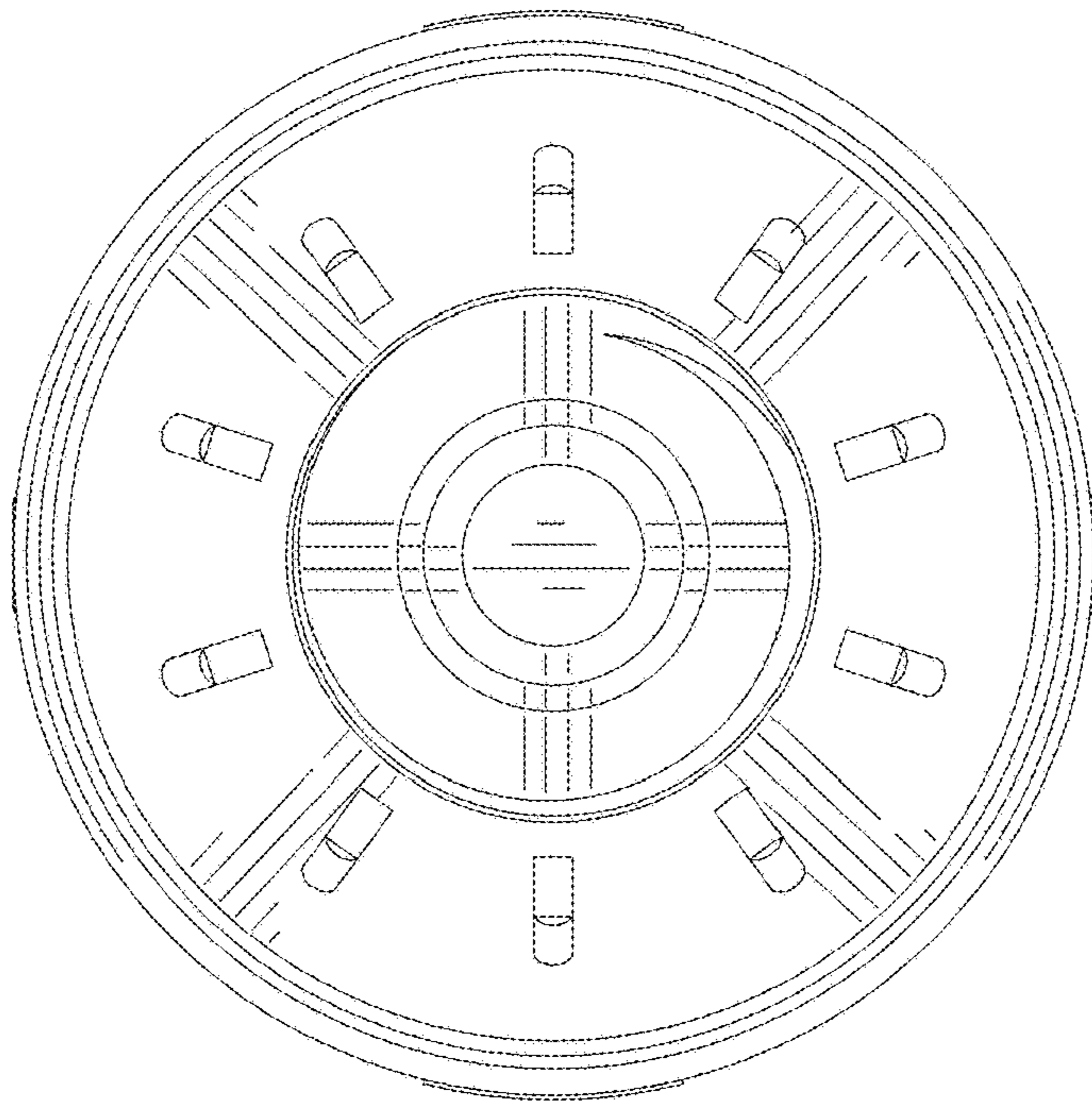

FIG. 8