



US00D831157S

(12) **United States Design Patent**
Kronk

(10) **Patent No.:** **US D831,157 S**
(45) **Date of Patent:** **** Oct. 16, 2018**

(54) **FILTER SUPPORT STRUCTURE**

DESCRIPTION

(71) Applicant: **Living Water Group Pty Ltd**, Palm Beach (AU)
(72) Inventor: **Jeremy Kronk**, Palm Beach (AU)
(73) Assignee: **Living Water Group Pty Ltd**, Palm Beach (AU)
(**) Term: **15 Years**
(21) Appl. No.: **29/609,502**
(22) Filed: **Jun. 30, 2017**
(51) **LOC (11) Cl.** **23-01**
(52) **U.S. Cl.**
USPC **D23/209**; D23/365
(58) **Field of Classification Search**
USPC D23/207, 209, 365
CPC . C02F 1/003; C02F 1/42; B01D 35/30; B01D 35/153; B01D 29/111; B01D 39/12; B01D 46/10; B29C 47/682
See application file for complete search history.

(56) **References Cited**

U.S. PATENT DOCUMENTS

2,425,235 A * 8/1947 Ferrante B01D 39/12
210/499
2,468,296 A * 4/1949 Jacobowitz B01D 29/39
210/486
5,373,615 A * 12/1994 Webb B01D 39/12
140/149
6,825,136 B2 * 11/2004 Cook B01D 39/12
209/309
D523,110 S * 6/2006 Anderson B01D 39/12
D23/209

(Continued)

Primary Examiner — Robin V Webster

(74) *Attorney, Agent, or Firm* — Richards Patent Law P.C.

(57) **CLAIM**

The ornamental design for a filter support structure, as shown and described.

FIG. 1 is a front perspective view of a filter support structure showing my new design;
FIG. 2 is a back perspective view of the filter support structure of FIG. 1;
FIG. 3 is a front elevational view of the filter support structure of FIG. 1;
FIG. 4 is a back elevational view of the filter support structure of FIG. 1;
FIG. 5 is a top view of the filter support structure of FIG. 1;
FIG. 6 is a bottom view of the filter support structure of FIG. 1;
FIG. 7 is a right side view of the filter support structure of FIG. 1;
FIG. 8 is a left side view of the filter support structure of FIG. 1;
FIG. 9 is a front perspective view of an alternative embodiment of the filter support structure;
FIG. 10 is a back perspective view of the filter support structure of FIG. 9;
FIG. 11 is a front elevational view of the filter support structure of FIG. 9;
FIG. 12 is a back elevational view of the filter support structure of FIG. 9;
FIG. 13 is a top view of the filter support structure of FIG. 9;
FIG. 14 is a bottom view of the filter support structure of FIG. 9;
FIG. 15 is a bottom view of the filter support structure of FIG. 9; and,
FIG. 16 is a right side view of the filter support structure of FIG. 9.
Those portions of the figures that are presented in broken lines merely illustrate the environment of the design and are not part of the claimed design.

1 Claim, 12 Drawing Sheets

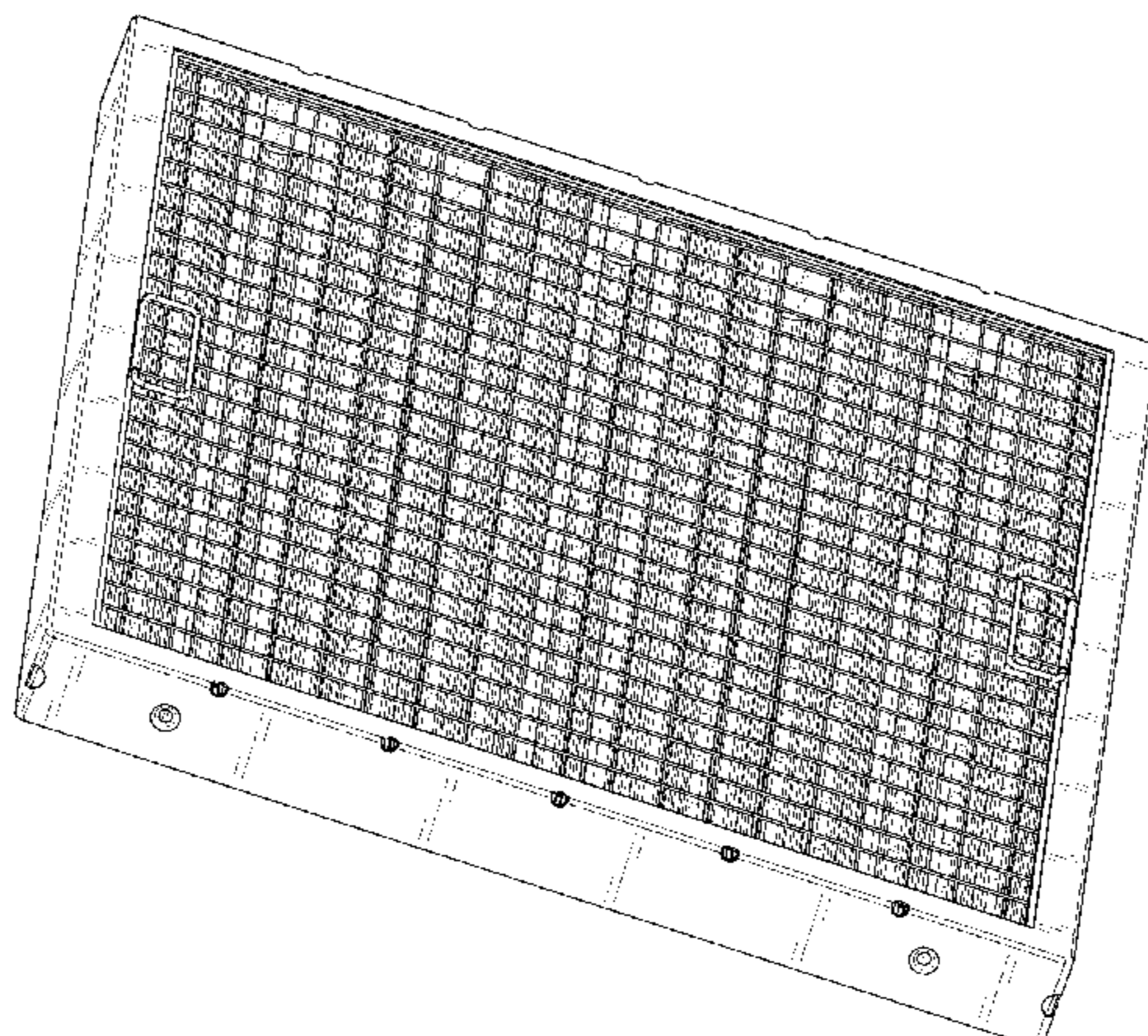

(56)

References Cited

U.S. PATENT DOCUMENTS

D538,418 S * 3/2007 Pippel B01D 39/12
D23/209
D628,267 S * 11/2010 Dittmann B01D 29/39
D23/209
8,182,571 B2 * 5/2012 Kailani B01D 46/0002
55/496
8,992,650 B2 * 3/2015 Rahmathullah B01D 46/0005
55/495
9,573,089 B2 * 2/2017 Yamaguchi B01D 46/521
9,687,766 B2 * 6/2017 Crabtree B01D 46/0023

* cited by examiner

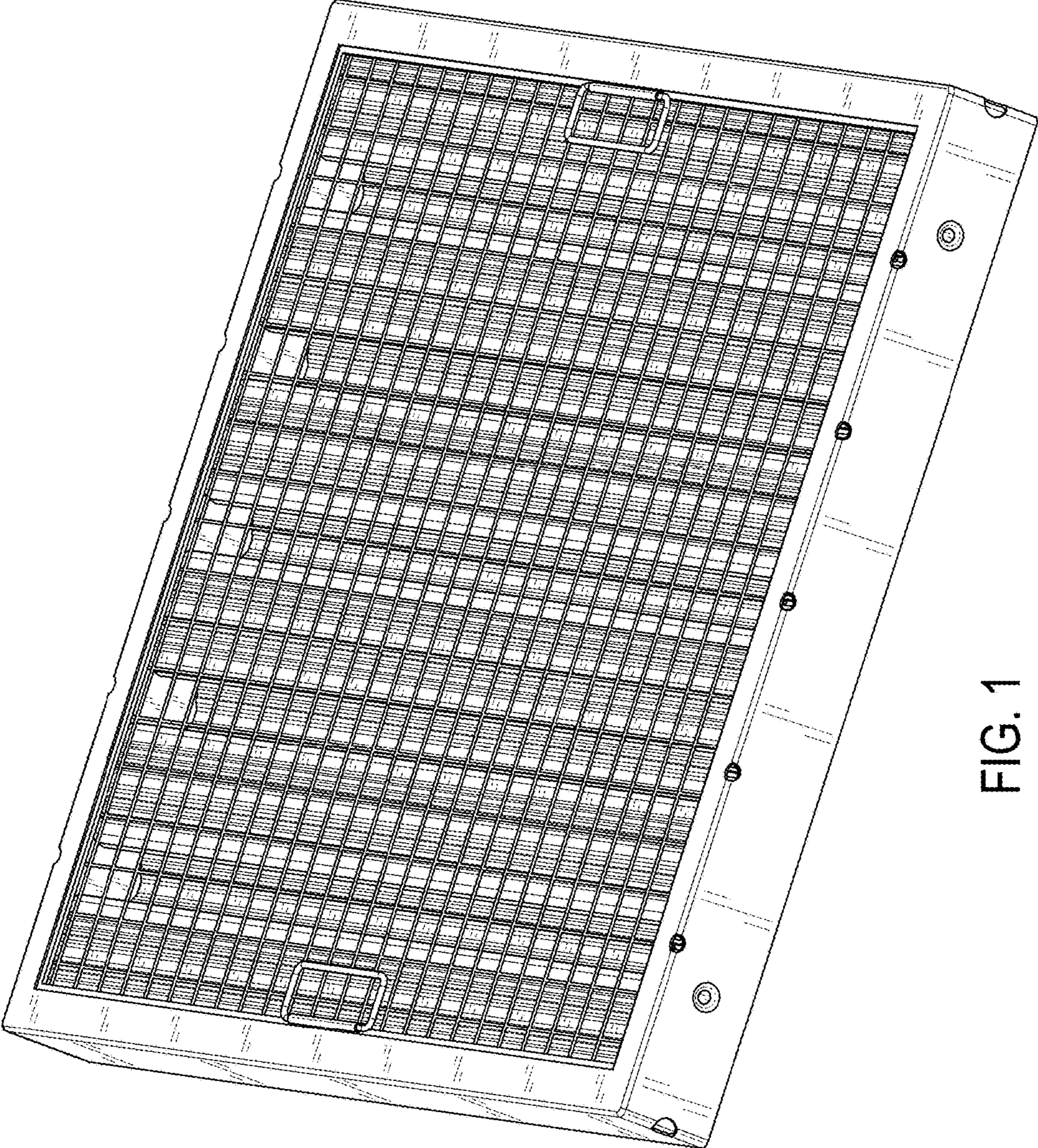

FIG. 1

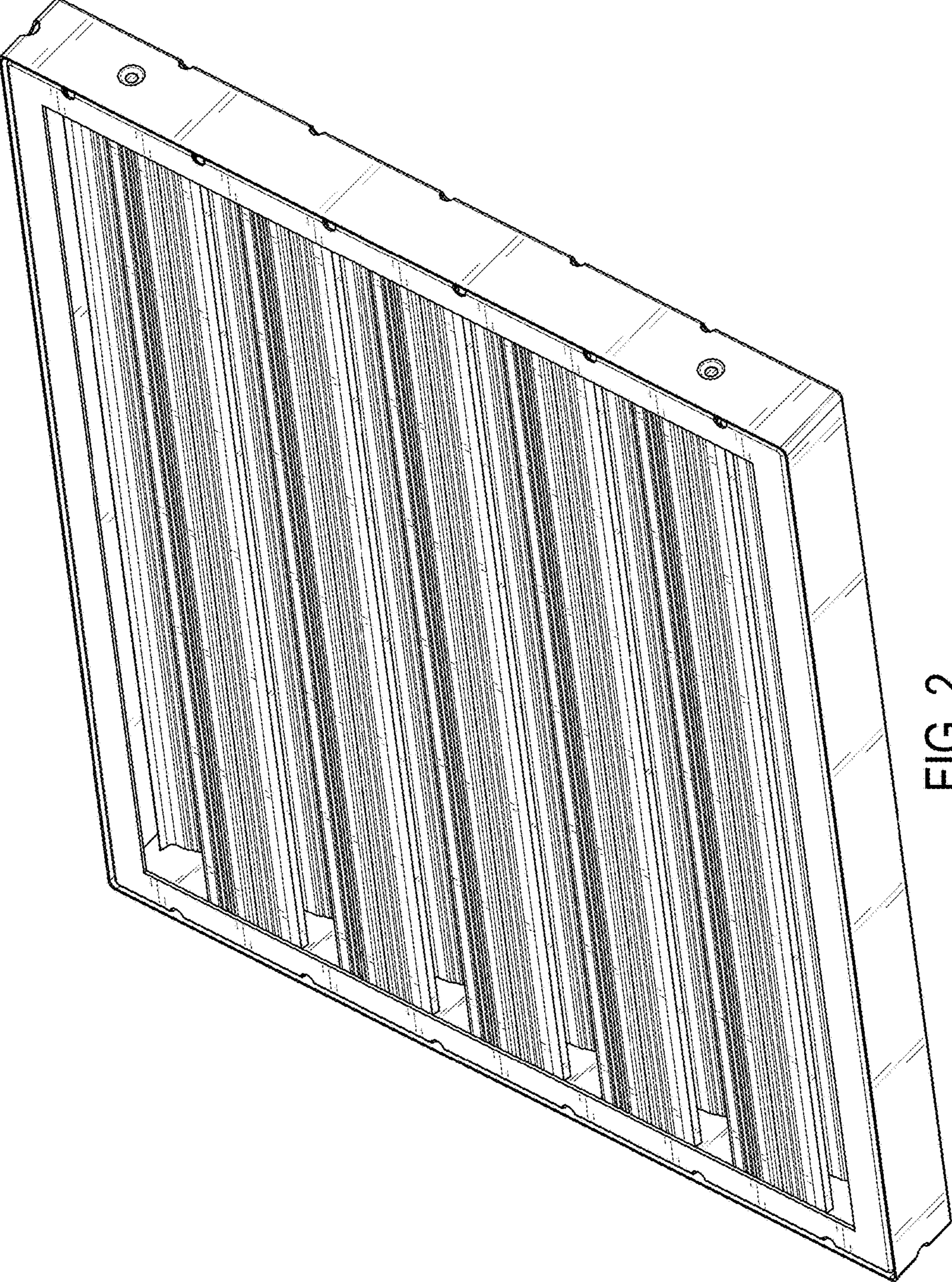

FIG. 2

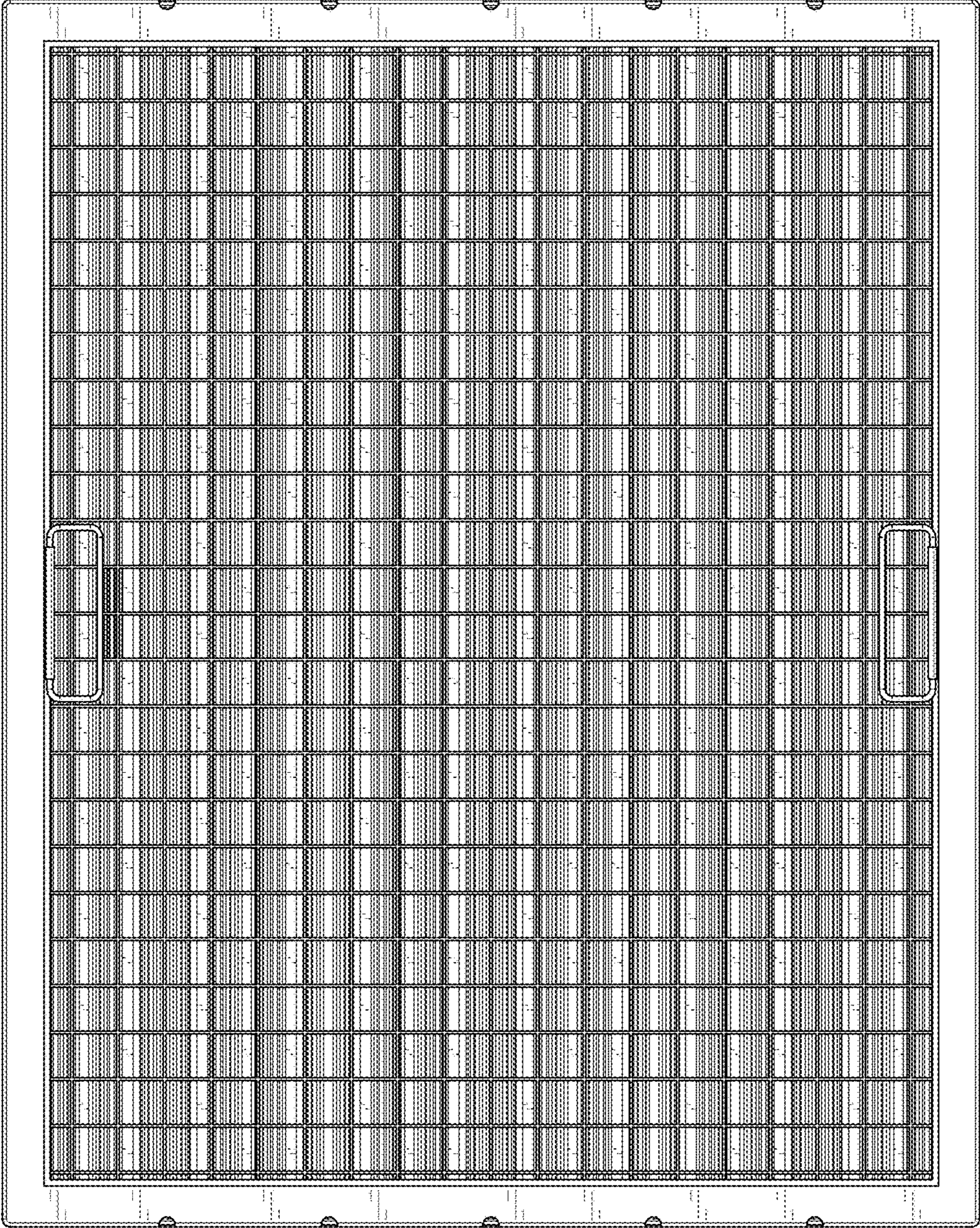

FIG. 3

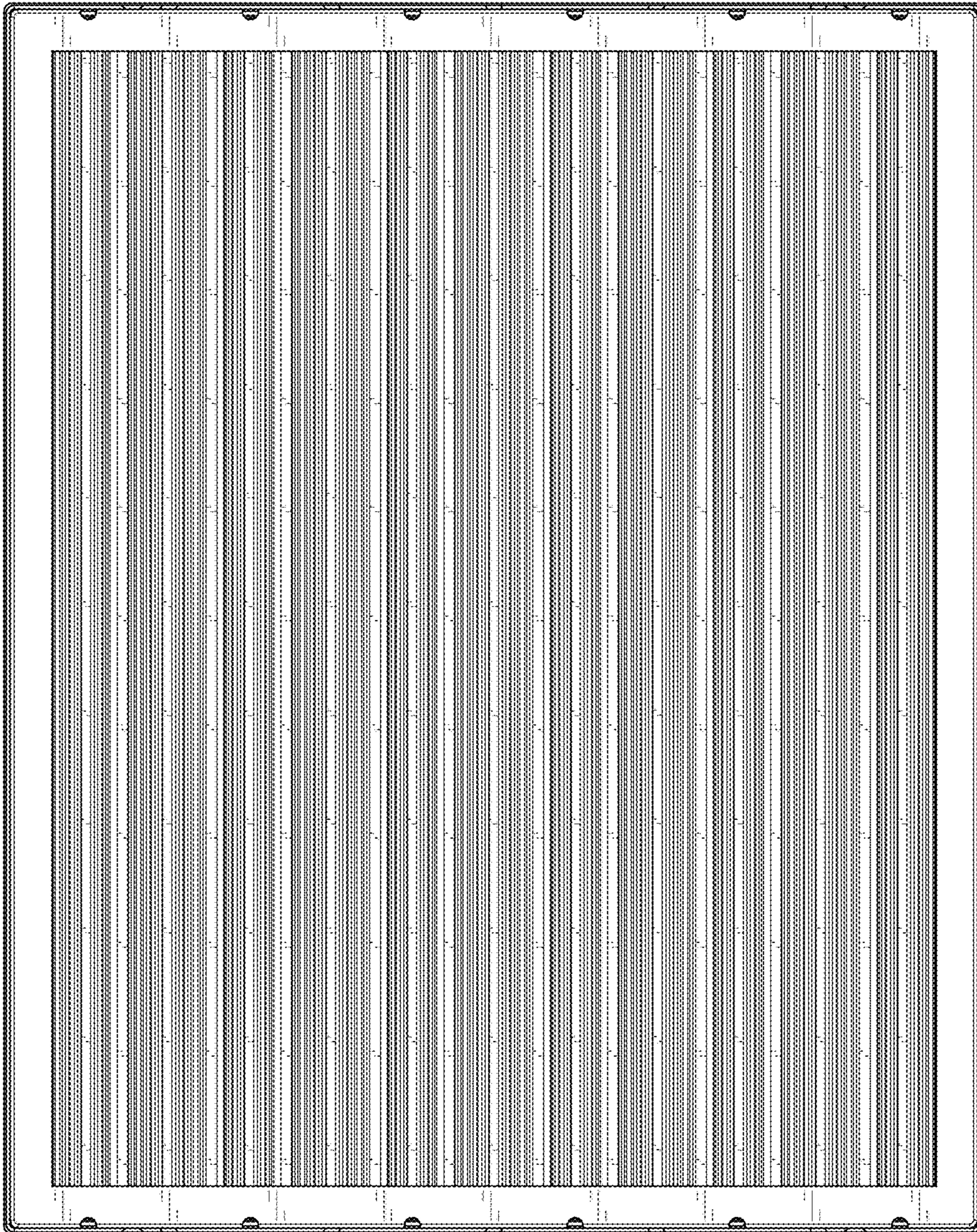

FIG. 4

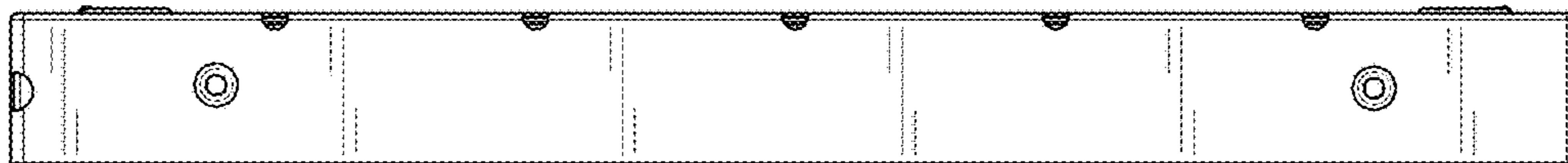

FIG. 6

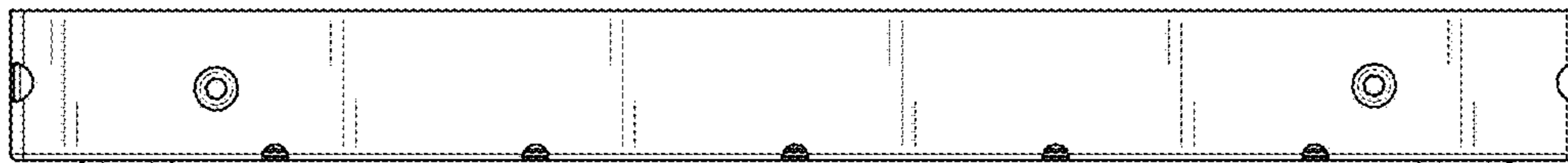

FIG. 5

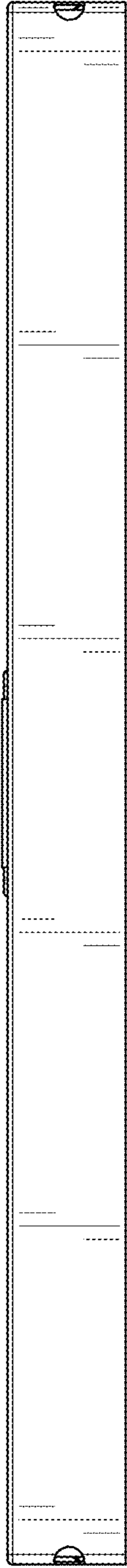

FIG. 7

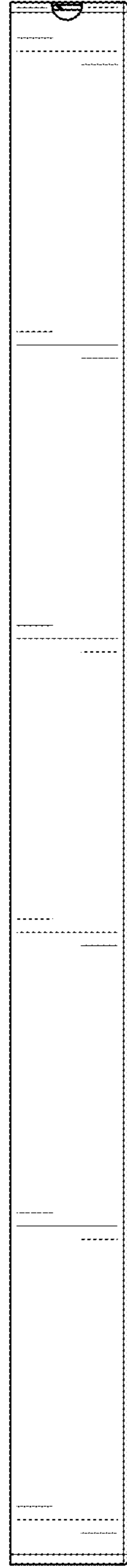

FIG. 8

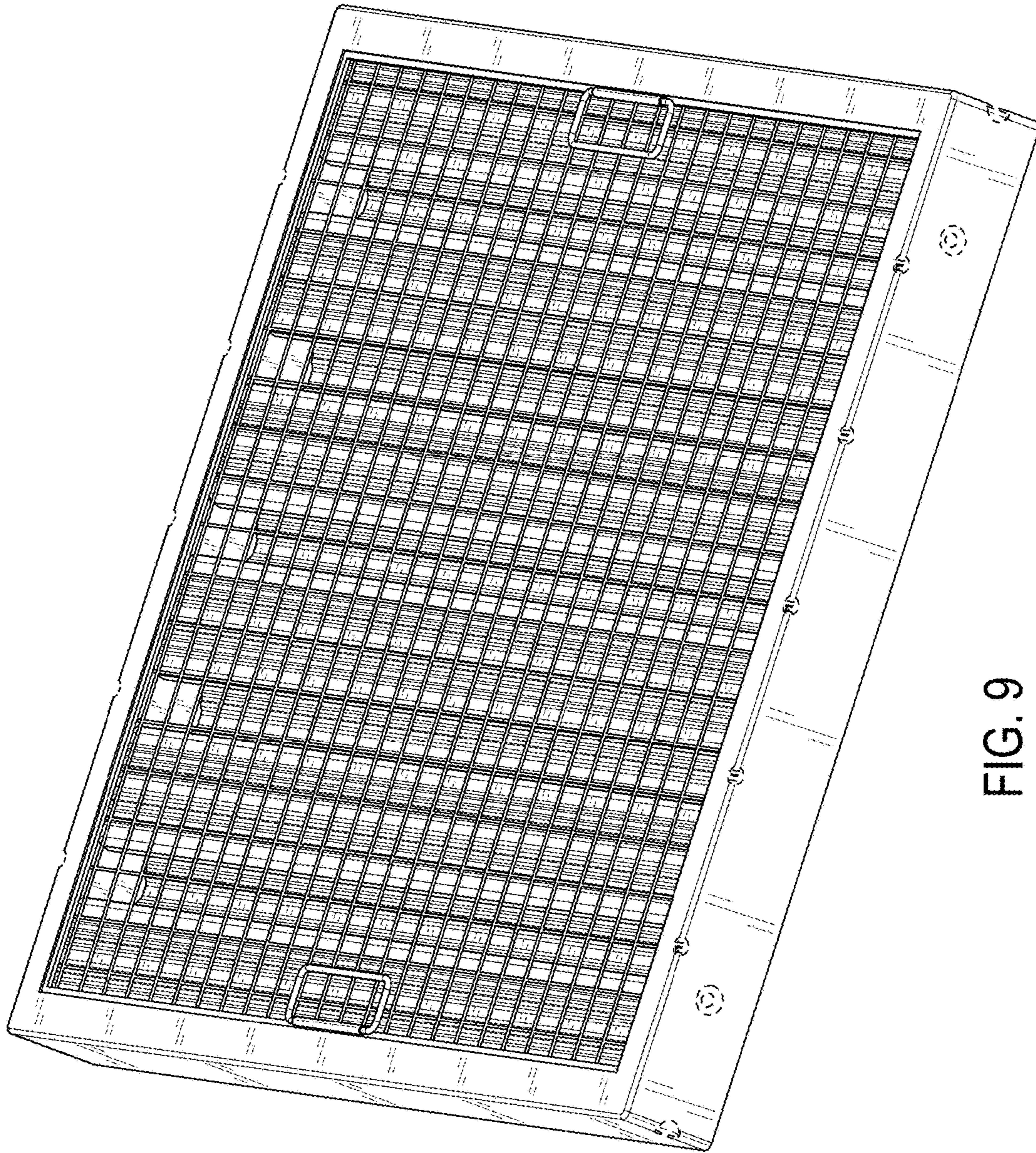

FIG. 9

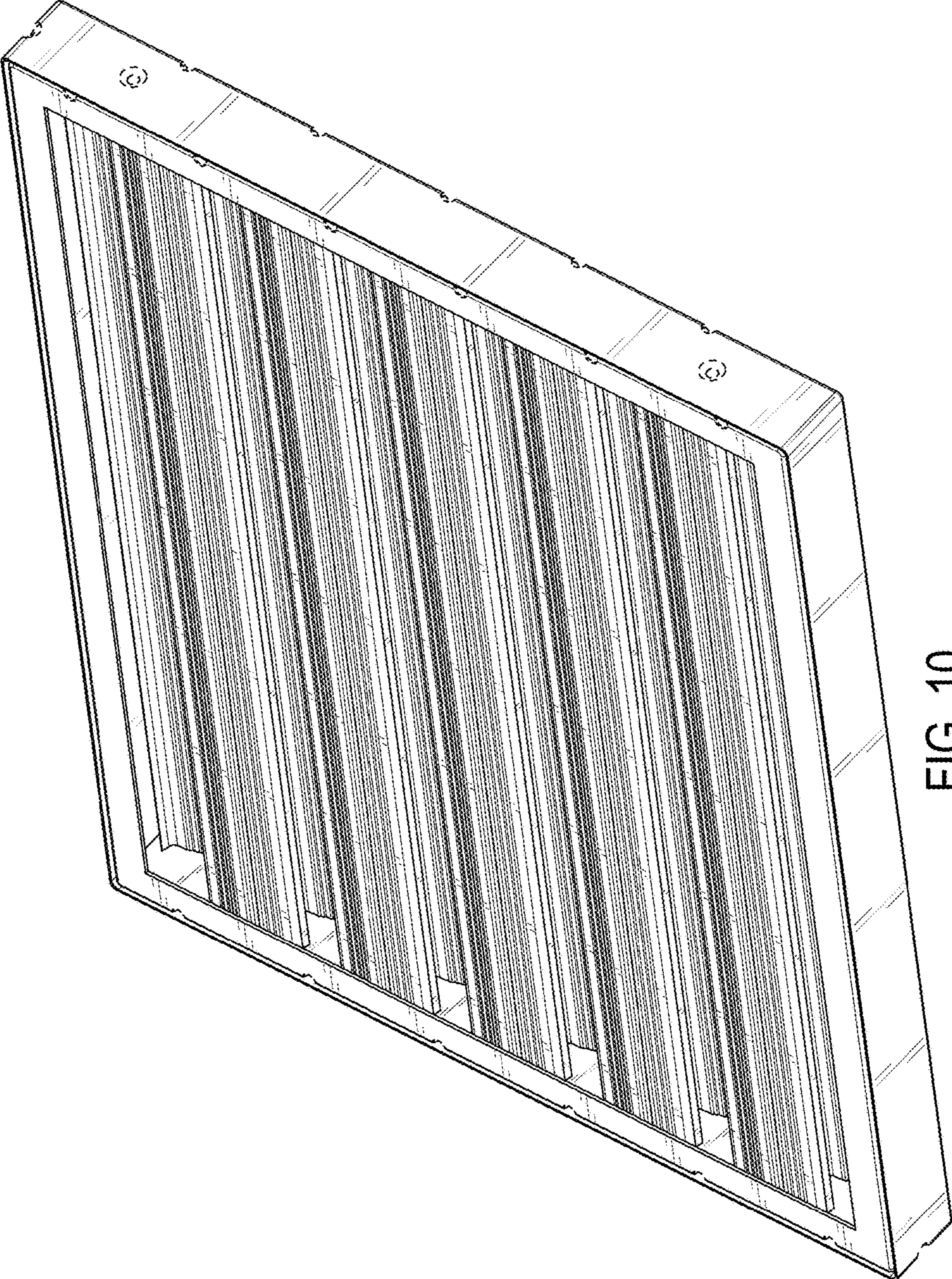

FIG. 10

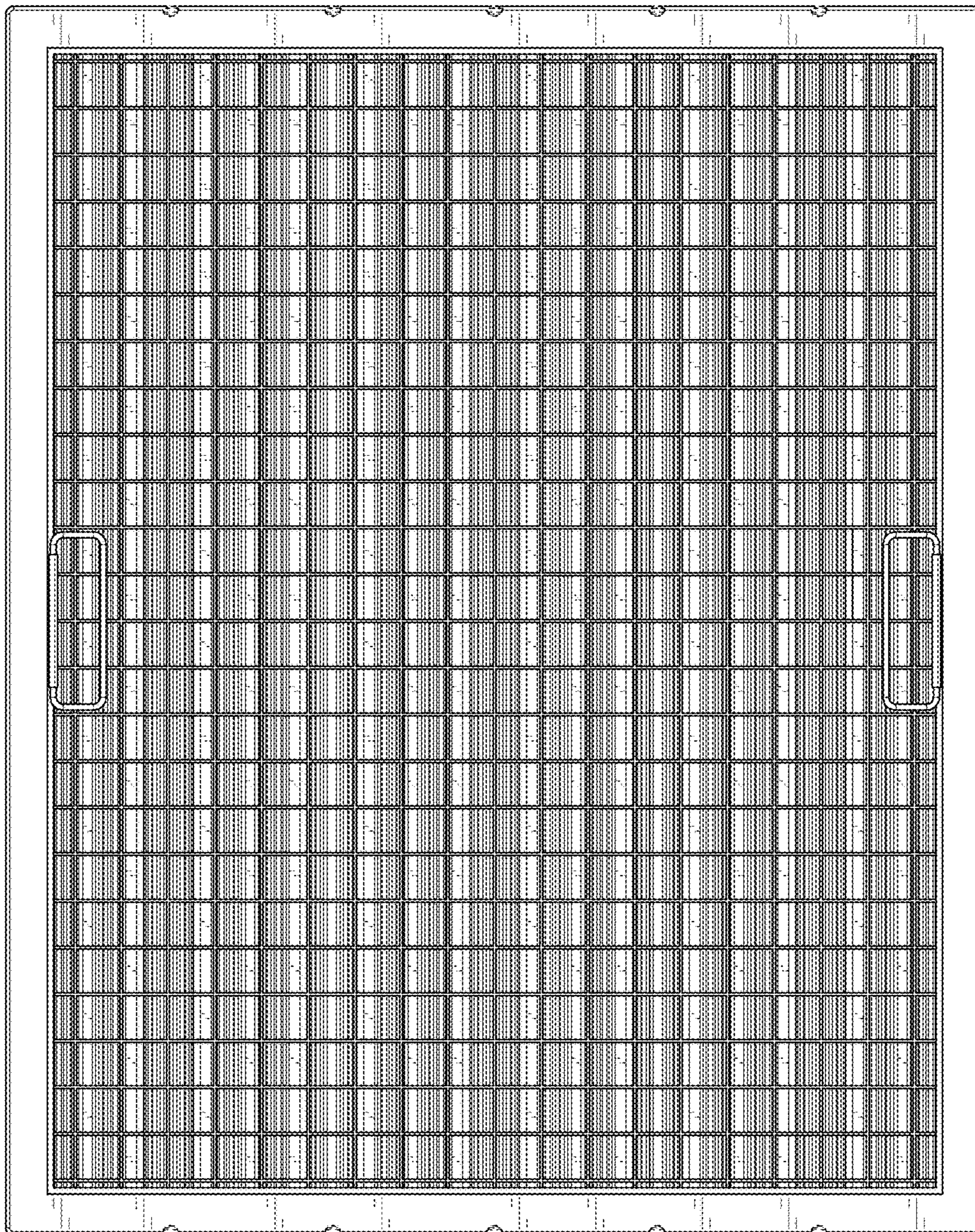

FIG. 11

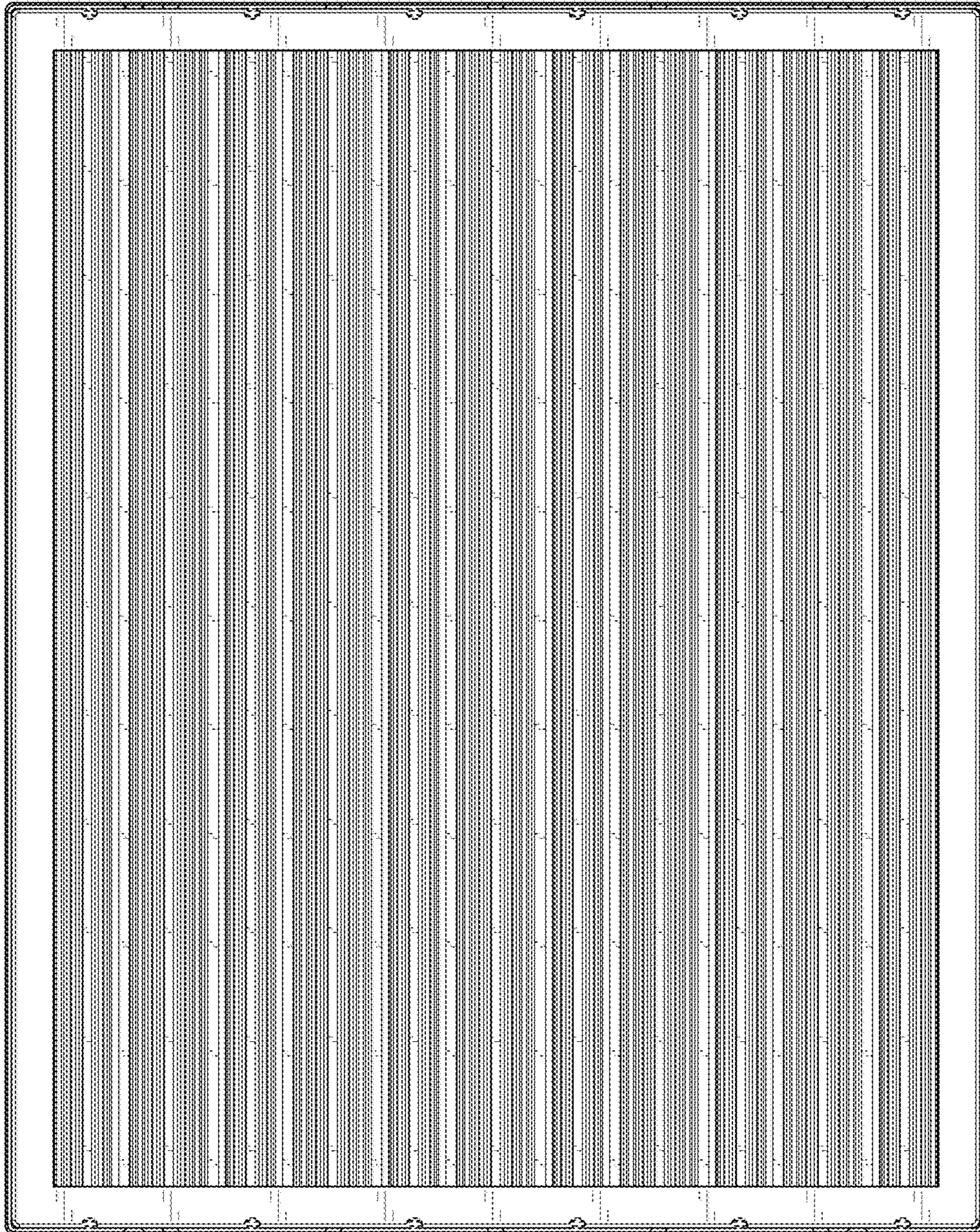

FIG. 12

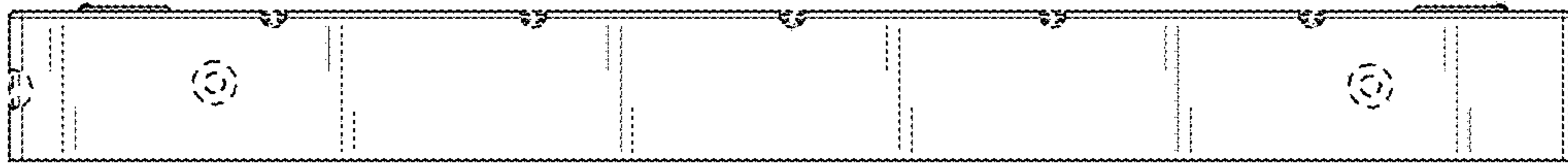

FIG. 14



FIG. 13



FIG. 15

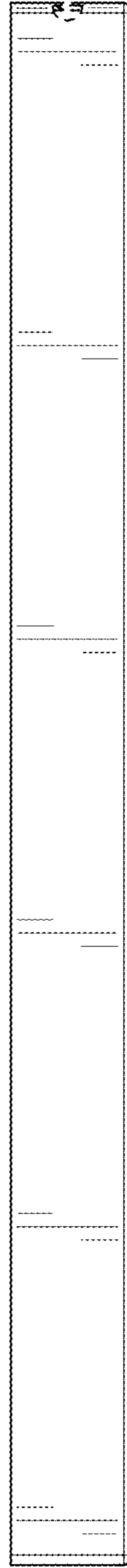

FIG. 16