



US00D831116S

(12) **United States Design Patent** (10) **Patent No.:** **US D831,116 S**  
**Banas** (45) **Date of Patent:** **\*\* Oct. 16, 2018**

(54) **MAGNETIC CAR TOP SIGN**  
(71) Applicant: **Wayne Banas**, Frankfaut, NY (US)  
(72) Inventor: **Wayne Banas**, Frankfaut, NY (US)  
(\*\*) Term: **15 Years**  
(21) Appl. No.: **29/605,150**  
(22) Filed: **May 24, 2017**  
(51) **LOC (11) Cl.** ..... **20-03**  
(52) **U.S. Cl.**  
USPC ..... **D20/10**  
(58) **Field of Classification Search**  
USPC ..... D20/10, 11, 21-28, 37, 39-42, 99;  
D10/54, 109, 109.1, 111, 113.4, 114,  
D10/114.1  
CPC ..... G09F 1/00; G09F 1/02; G09F 2003/023;  
G09F 2003/0261; G09F 2003/0264; G09F  
7/00; G09F 3/206; G09F 13/00; G09F  
2007/1807; G09F 13/04; G09F  
2013/0427; G09F 2013/0495; G09F 7/04;  
G09D 3/00; B60Q 1/2611; B60Q 1/50  
See application file for complete search history.

4,888,893 A \* 12/1989 Jones ..... G09F 7/12  
40/592  
D313,661 S \* 1/1991 Kang ..... D10/114.1  
D386,209 S \* 11/1997 Firestone ..... D20/10  
D388,126 S \* 12/1997 Rath ..... D20/10  
5,754,098 A \* 5/1998 Holban ..... B60Q 1/2611  
340/434  
D398,409 S \* 9/1998 Jessa ..... D20/10  
D418,930 S \* 1/2000 De Leon ..... D20/10  
D447,774 S \* 9/2001 Elmer ..... D20/10  
D463,589 S \* 9/2002 Troyer ..... D26/28  
D478,935 S \* 8/2003 Gearhart ..... D12/162  
D480,432 S \* 10/2003 Newman ..... D20/10  
D484,633 S \* 12/2003 Campagna ..... D26/72  
D495,747 S \* 9/2004 Boodhoo ..... D20/10  
D508,539 S \* 8/2005 Gaines ..... D20/17  
D511,391 S \* 11/2005 Altman ..... D20/10  
D524,673 S \* 7/2006 Dicke ..... D10/114.1  
D578,684 S \* 10/2008 Marquardt ..... D26/28  
D617,384 S \* 6/2010 Elmer ..... D20/10  
D641,900 S \* 7/2011 Iqbal ..... D26/31

(Continued)

*Primary Examiner* — Mary Ann Calabrese  
*Assistant Examiner* — Sloan Rozin  
(74) *Attorney, Agent, or Firm* — IPS Legal Group, P.A.

(57) **CLAIM**

The ornamental design for a magnetic car top sign, as shown and described.

**DESCRIPTION**

FIG. 1 is a perspective view of the present invention.  
FIG. 2 is a front view of the present invention.  
FIG. 3 is a rear view of the present invention.  
FIG. 4 is a top view of the present invention.  
FIG. 5 is a bottom view of the present invention.  
FIG. 6 is a left view of the present invention; and,  
FIG. 7 is a right view of the present invention.  
The broken line showing elements on the magnetic car top sign illustrate portions of the article and form no part of the claimed design.

**1 Claim, 5 Drawing Sheets**

(56) **References Cited**  
U.S. PATENT DOCUMENTS  
D152,497 S \* 1/1949 Price et al. .... D20/10  
2,478,178 A \* 8/1949 Brasington ..... B60Q 1/2611  
340/472  
2,783,451 A \* 2/1957 Stout ..... B60Q 7/00  
340/434  
2,814,028 A \* 11/1957 Hamilton ..... G07B 13/045  
340/434  
2,968,025 A \* 1/1961 Owens ..... B60Q 1/2611  
318/467  
4,067,128 A \* 1/1978 Kempster ..... G09F 11/23  
40/473  
D279,485 S \* 7/1985 Brennan ..... D20/17

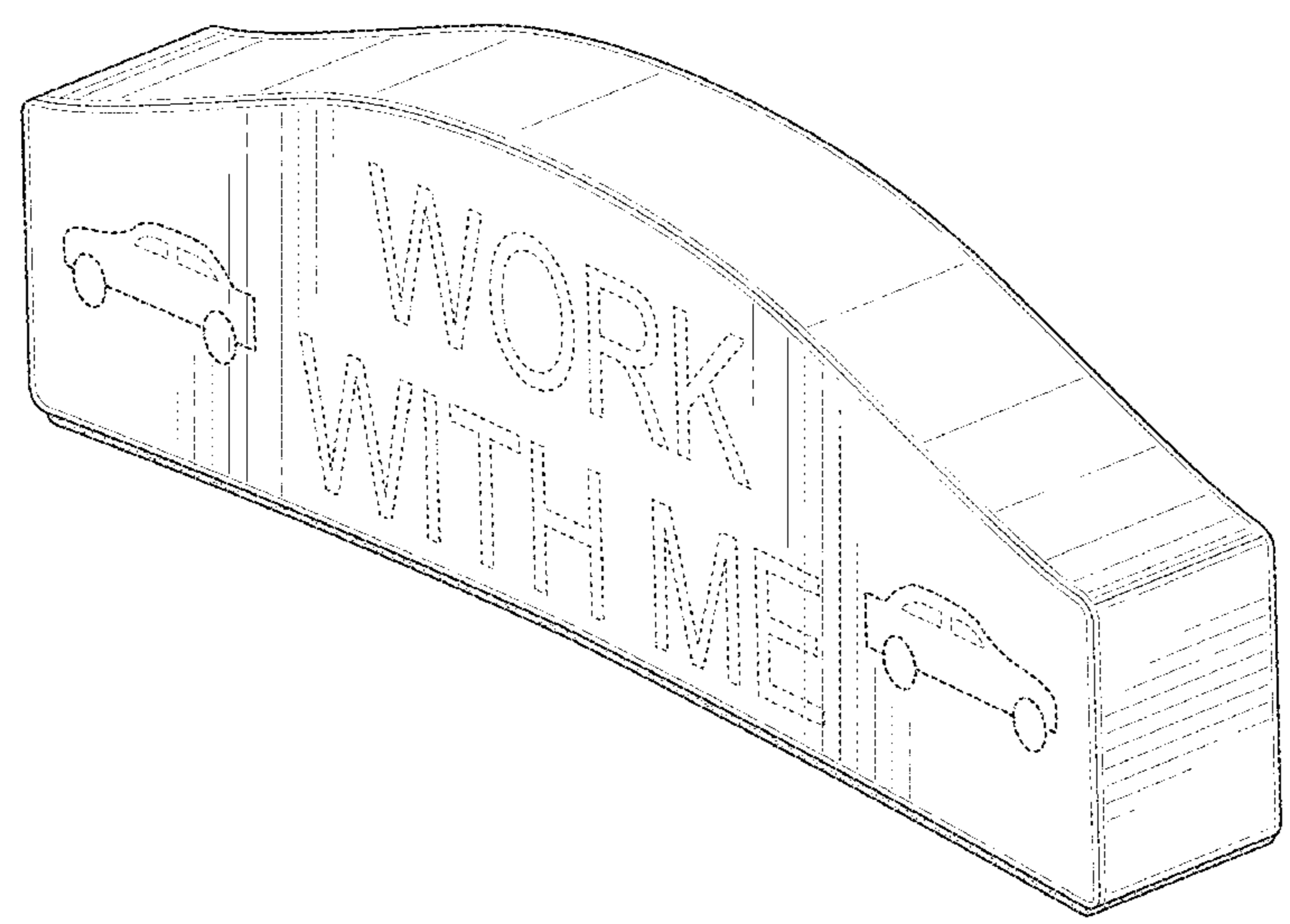

(56)

**References Cited**

U.S. PATENT DOCUMENTS

D670,592 S \* 11/2012 Ten Wolde ..... D10/114.2  
D695,445 S \* 12/2013 Panchisin ..... D26/118  
D724,673 S \* 3/2015 Li ..... D20/42  
D740,472 S \* 10/2015 Linton ..... D26/31  
D763,357 S \* 8/2016 Tsuru ..... D20/42  
D777,840 S \* 1/2017 Kott ..... D20/43  
D779,984 S \* 2/2017 Deyaf ..... D10/114.2  
2006/0103543 A1 \* 5/2006 Chen ..... B60Q 7/00  
340/815.45  
2017/0053574 A1 \* 2/2017 Byrd ..... G09F 21/04  
2017/0336034 A1 \* 11/2017 Gawel ..... F21V 33/008  
2018/0037156 A1 \* 2/2018 Stevens ..... B60Q 1/2607

\* cited by examiner

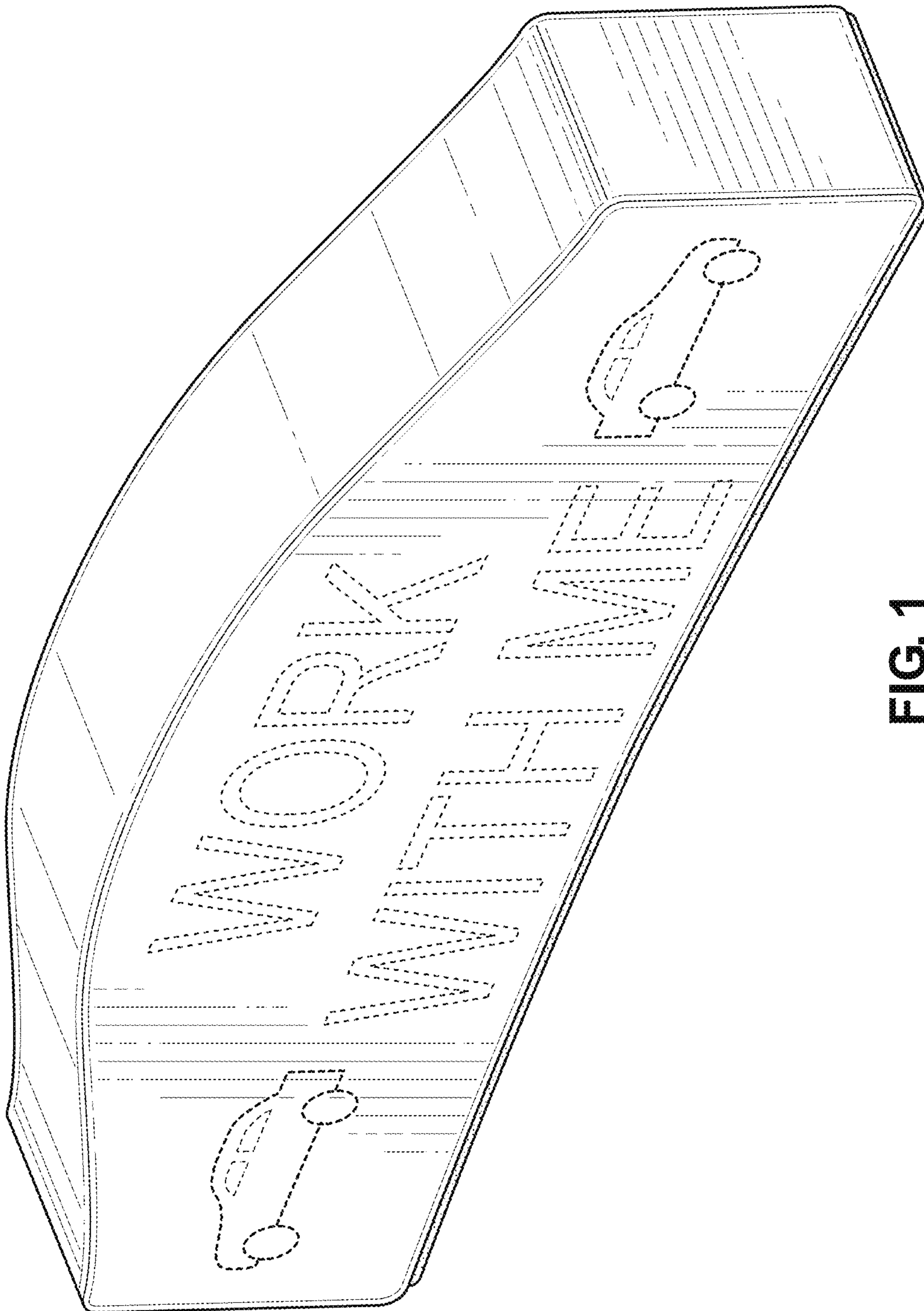

FIG. 1

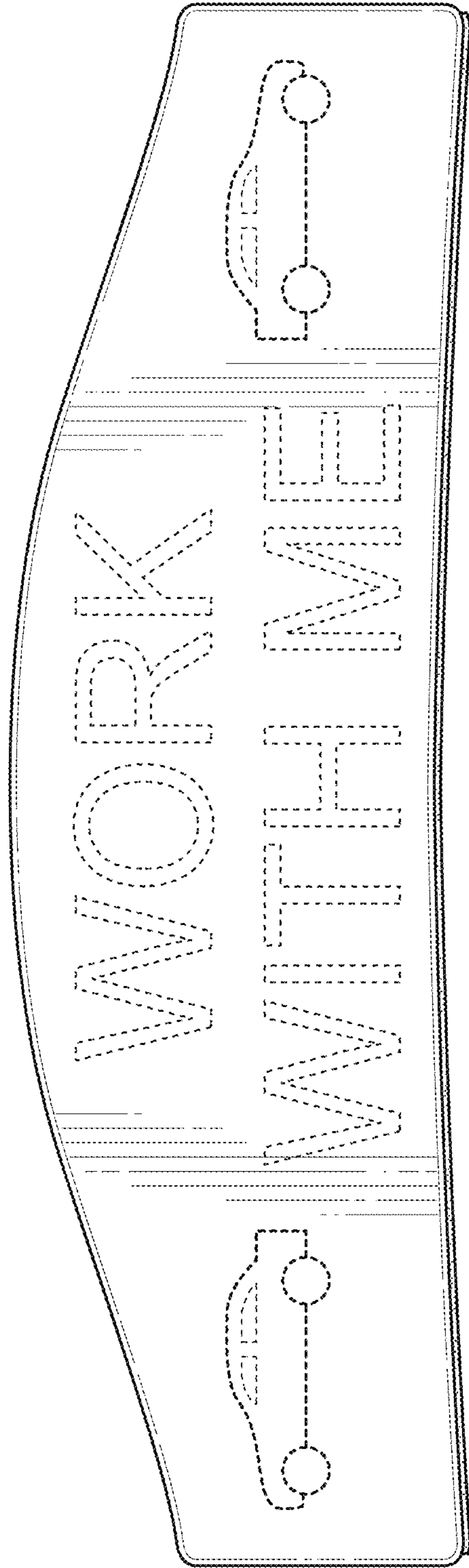

FIG. 2

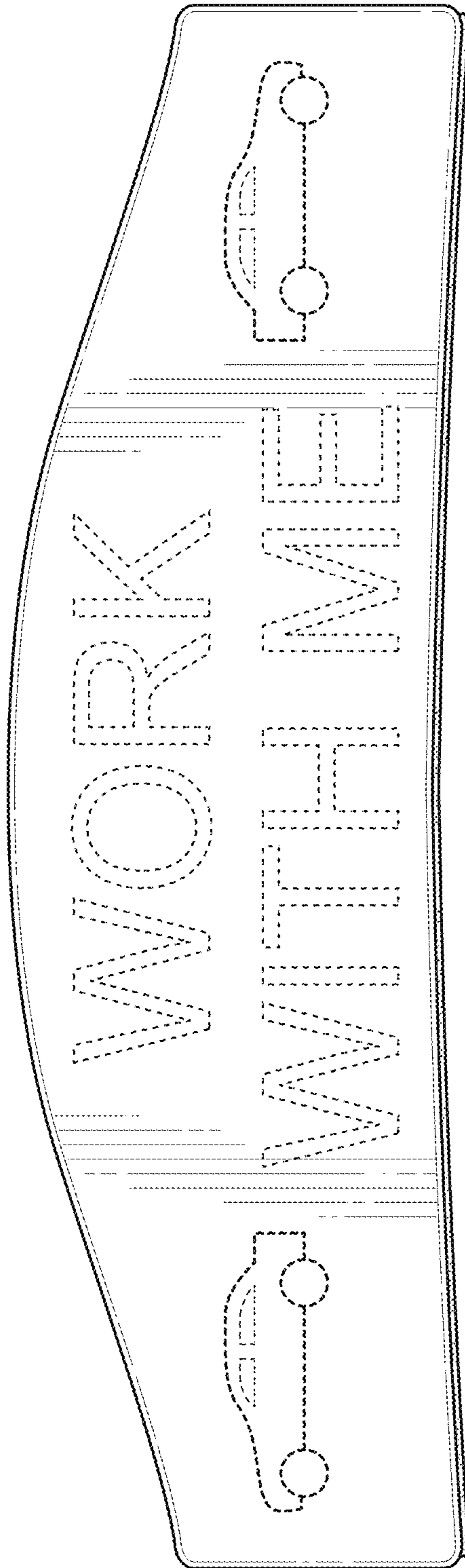
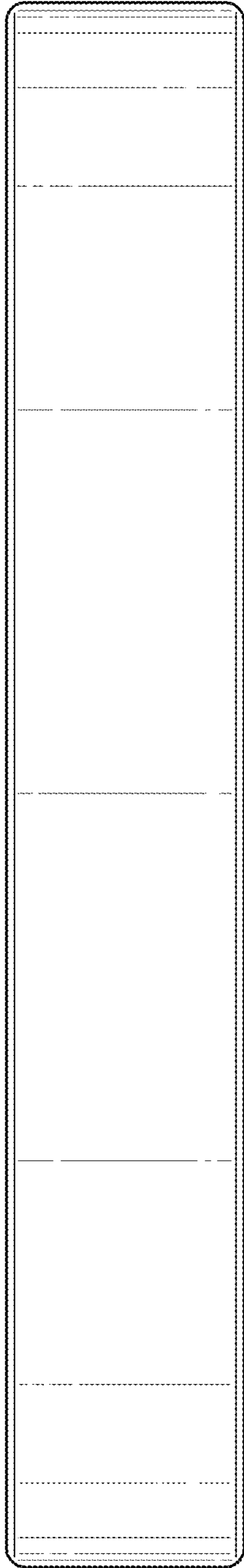
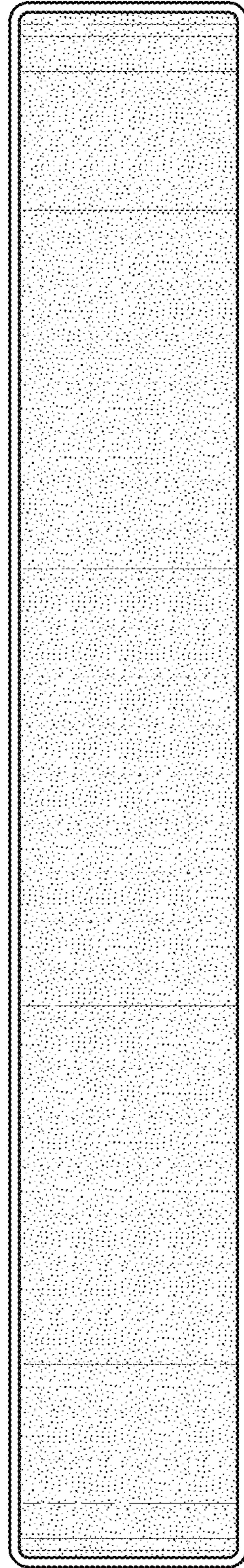

FIG. 3



**FIG. 4**



**FIG. 5**

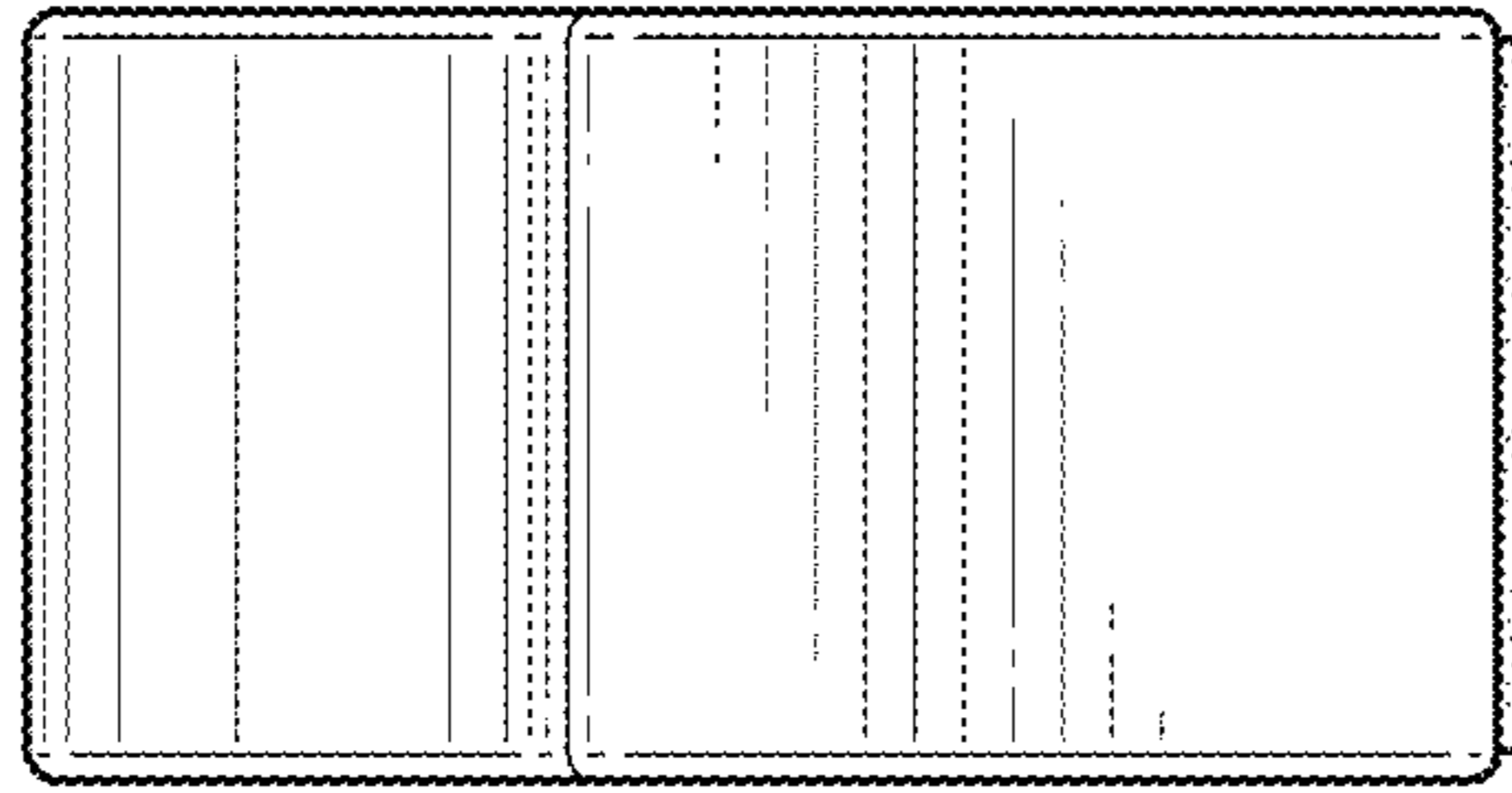

FIG. 7

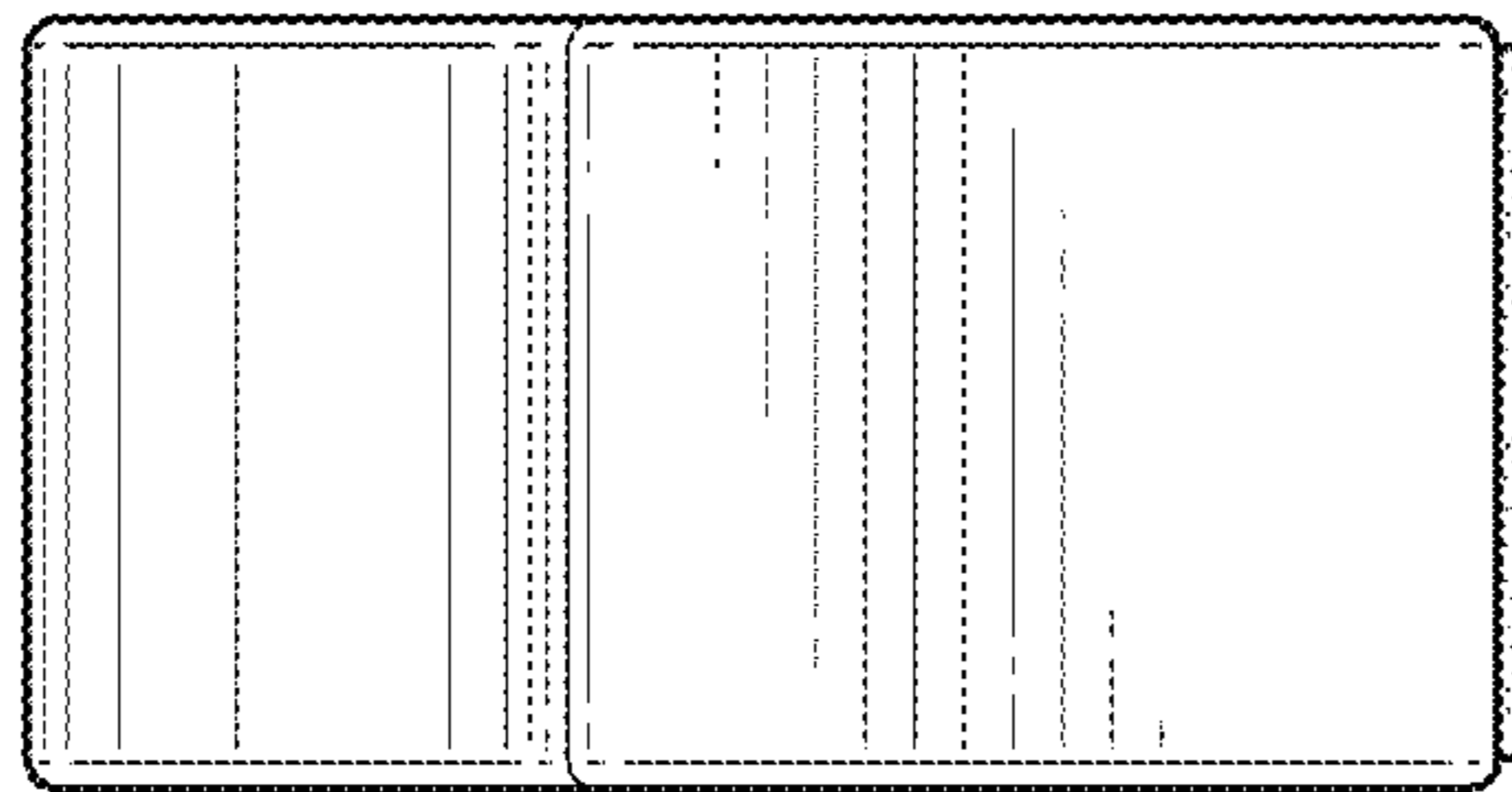

FIG. 6