



US00D831023S

(12) **United States Design Patent** (10) **Patent No.:** **US D831,023 S**
Wellard (45) **Date of Patent:** **** Oct. 16, 2018**

(54) **AUTO STEREO MOUNTING DEVICE**
(71) Applicant: **Metra Electronics Corporation**, Holly Hill, FL (US)
(72) Inventor: **Kennesaw Wellard**, Holly Hill, FL (US)
(73) Assignee: **Metra Electronic Corporation**, Holly Hill, FL (US)
(**) Term: **15 Years**
(21) Appl. No.: **29/604,888**
(22) Filed: **May 22, 2017**
(51) **LOC (11) Cl.** **14-03**
(52) **U.S. Cl.**
USPC **D14/258**
(58) **Field of Classification Search**
USPC D12/192, 195, 415, 420; D14/496, D14/498-506, 154, 157, 168-171, D14/188-198, 257-258; 248/27.1, 27.3, 248/558; 455/347, 350
CPC B60R 11/02; B60K 37/04; B60K 37/06; H04B 1/08; H04B 1/082
See application file for complete search history.

(56) **References Cited**
U.S. PATENT DOCUMENTS
D555,647 S * 11/2007 Quilling, II D14/224
D639,292 S * 6/2011 Fiore, IV D14/258
D728,554 S * 5/2015 Fiore, IV D14/258
D755,777 S * 5/2016 Fiore, IV D14/258

* cited by examiner
Primary Examiner — Sandra L Morris
(74) *Attorney, Agent, or Firm* — J. Wiley Horton

(57) **CLAIM**
The ornamental design for an “auto stereo mounting device,” as shown and described.

DESCRIPTION

FIG. 1 is a perspective view of an auto stereo mounting device, showing my design;
FIG. 2 is a front elevation view of FIG. 1;
FIG. 3 is a rear elevation view of FIG. 1;
FIG. 4 is a right side elevation view of FIG. 1;
FIG. 5 is a left side elevation view of FIG. 1;
FIG. 6 is a top plan view of FIG. 1;
FIG. 7 is a bottom plan view of FIG. 1; and,
FIG. 8 is a rear perspective view of FIG. 1.
The broken lines shown in all views illustrate mounting features which form no part of the claimed design.

1 Claim, 7 Drawing Sheets

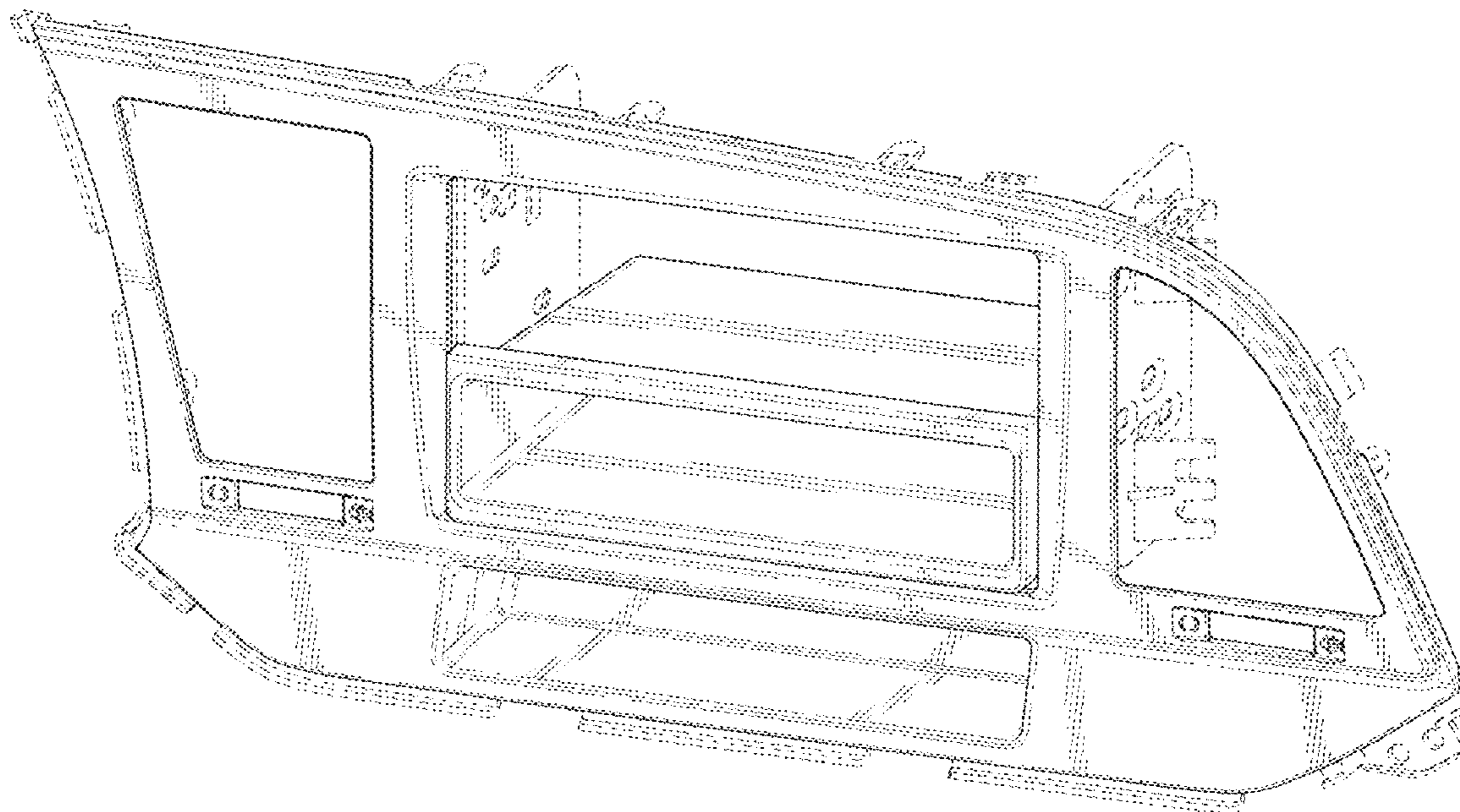

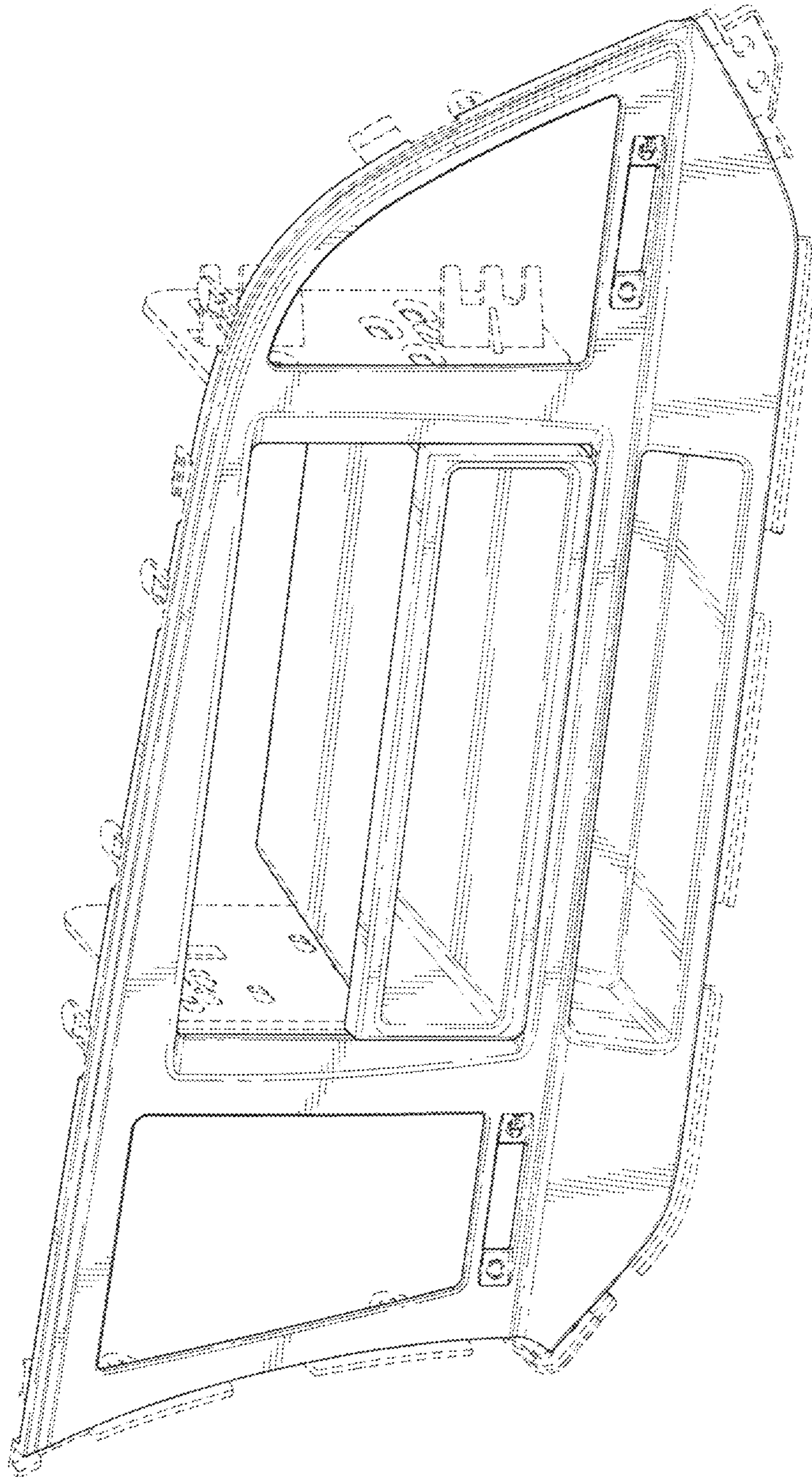

FIG. 1

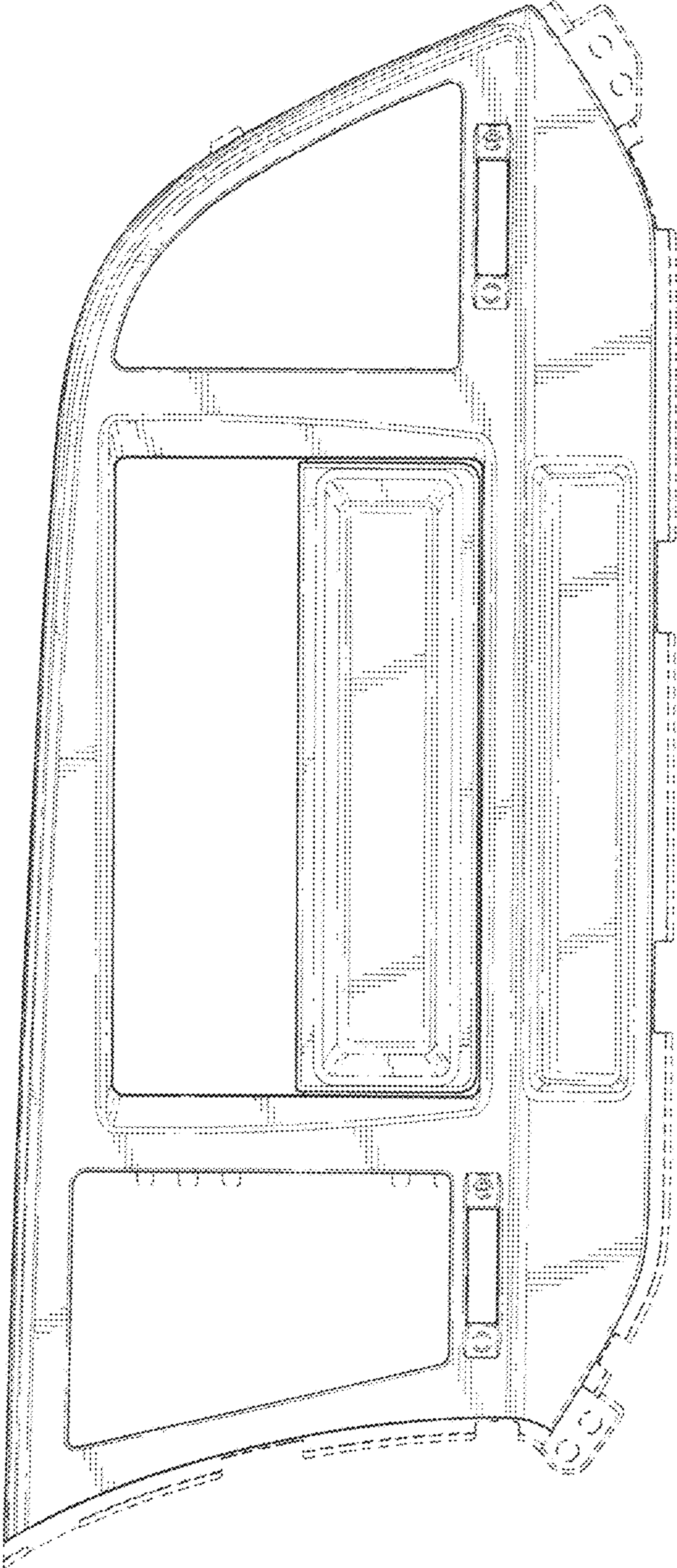

FIG. 2

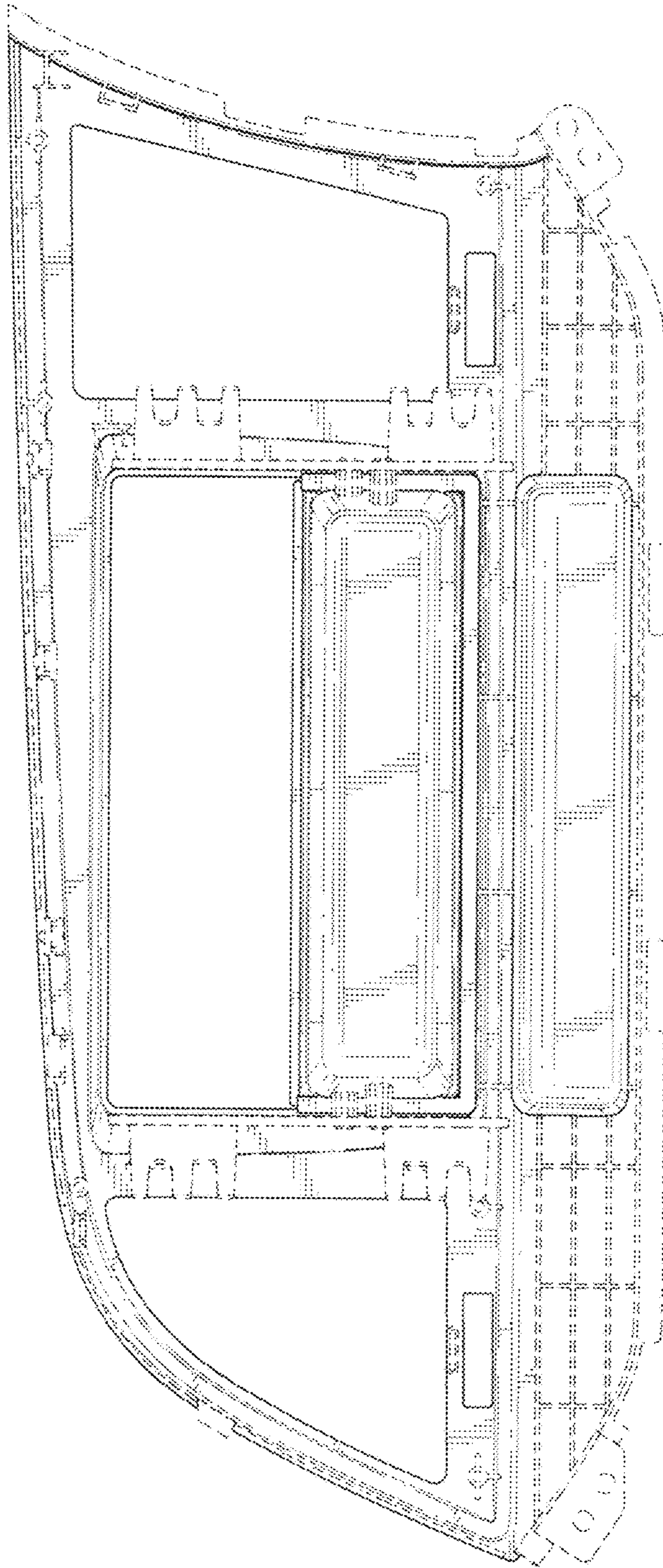

FIG. 3

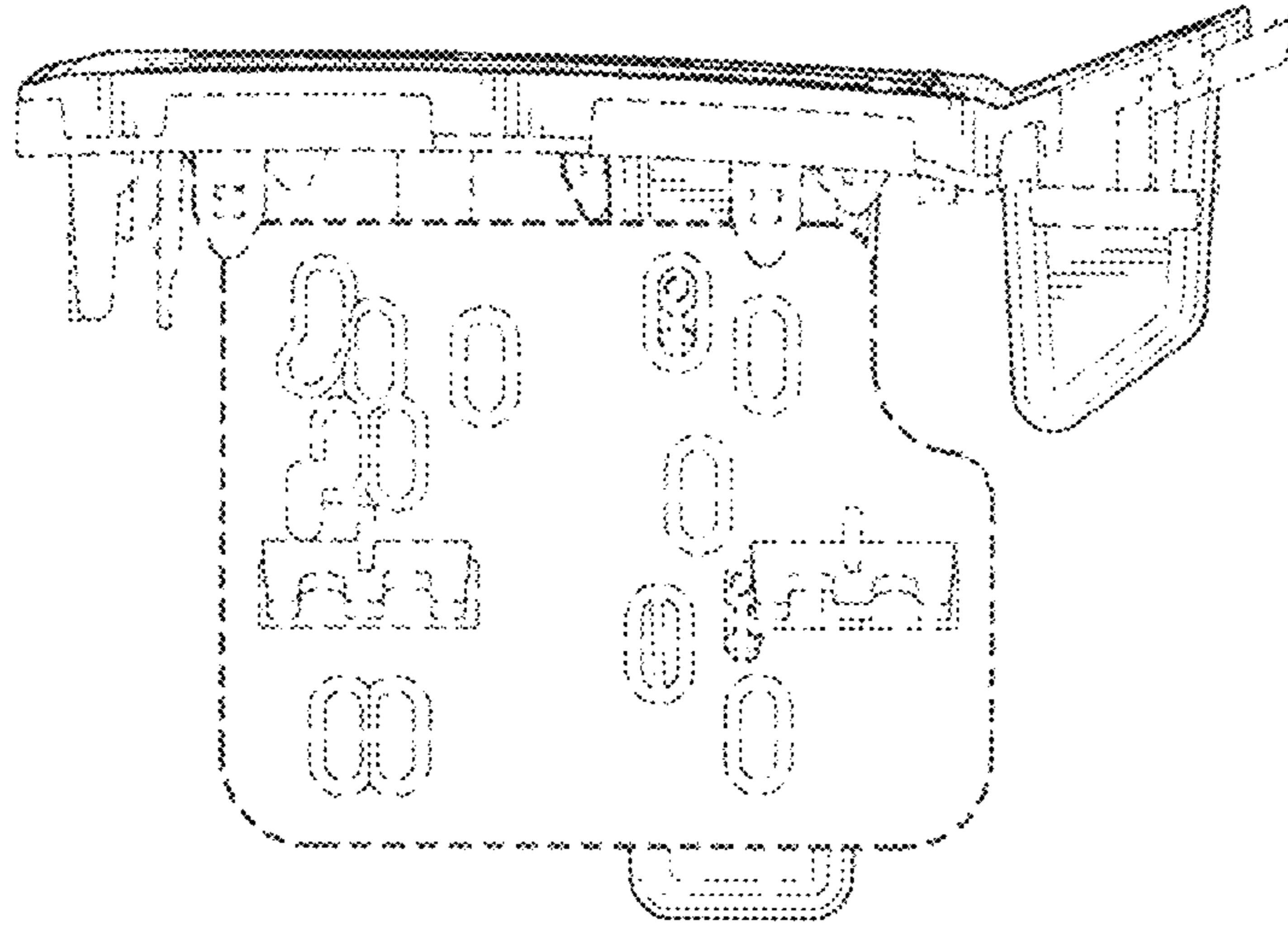

FIG. 5

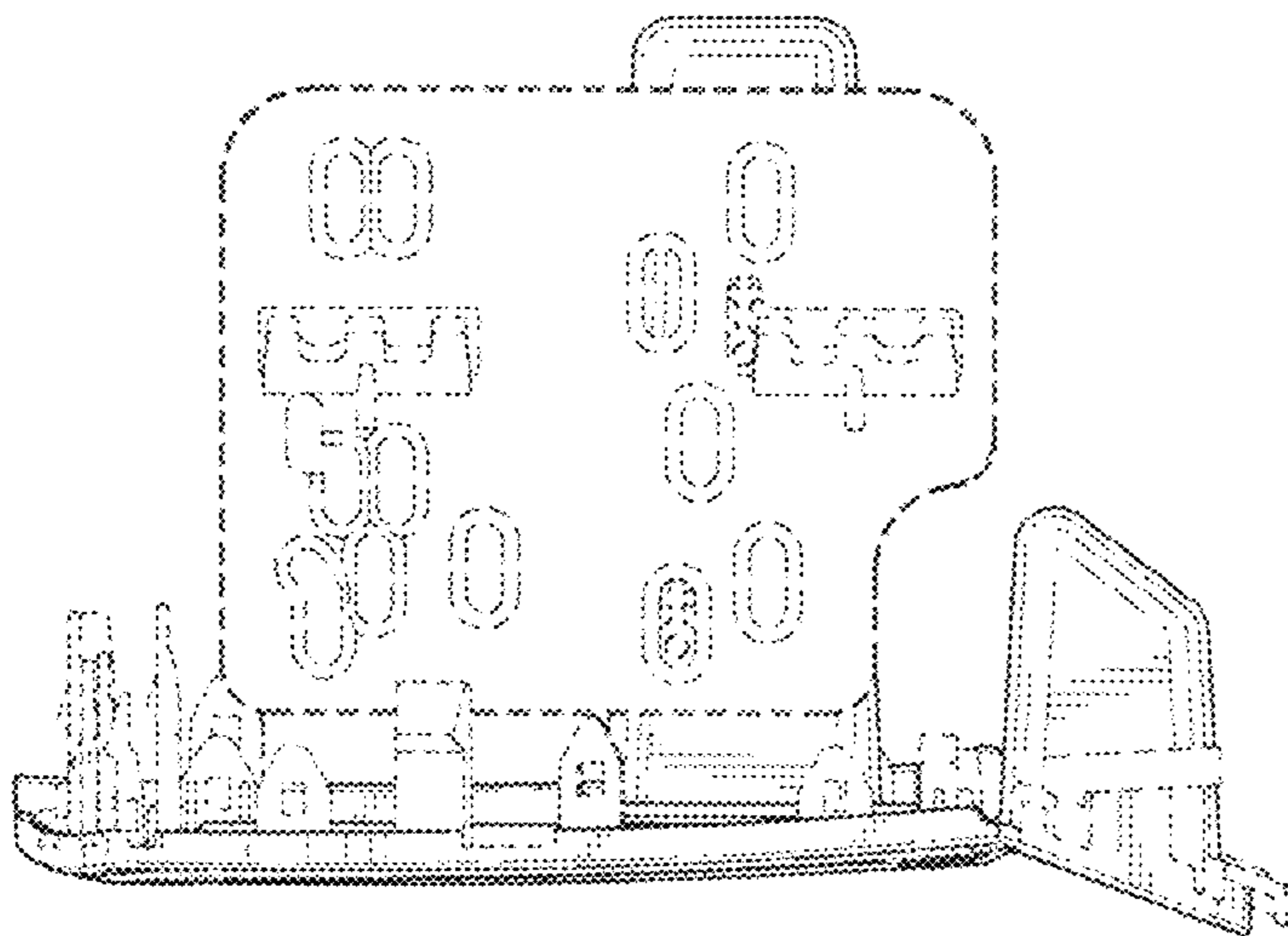

FIG. 4

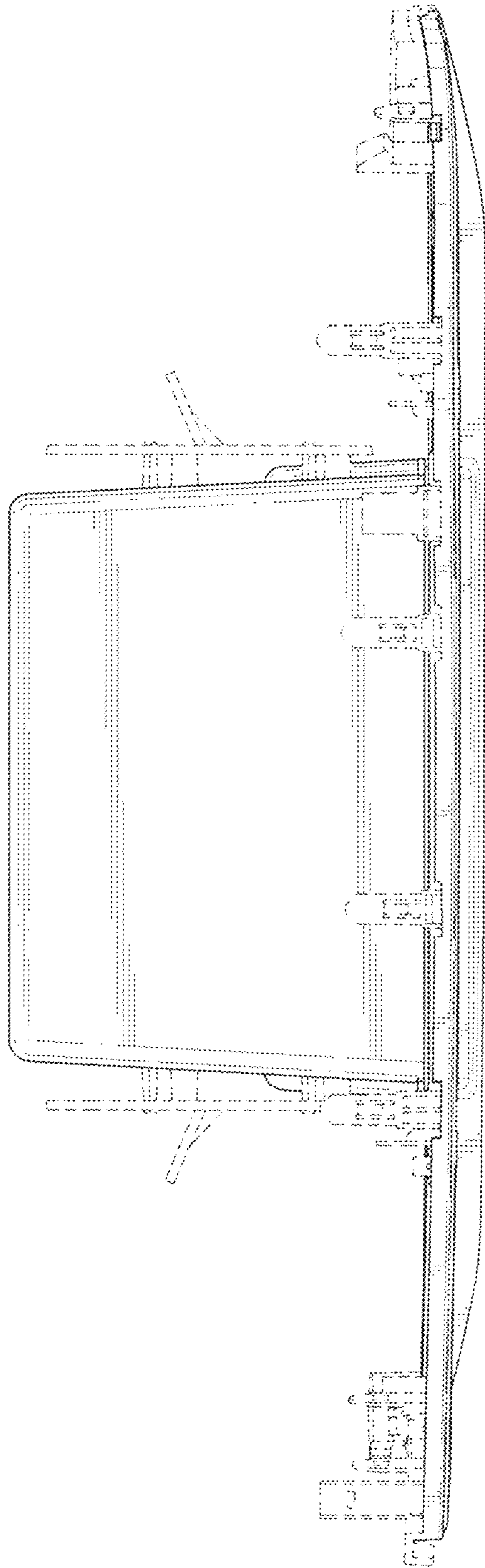

FIG. 6

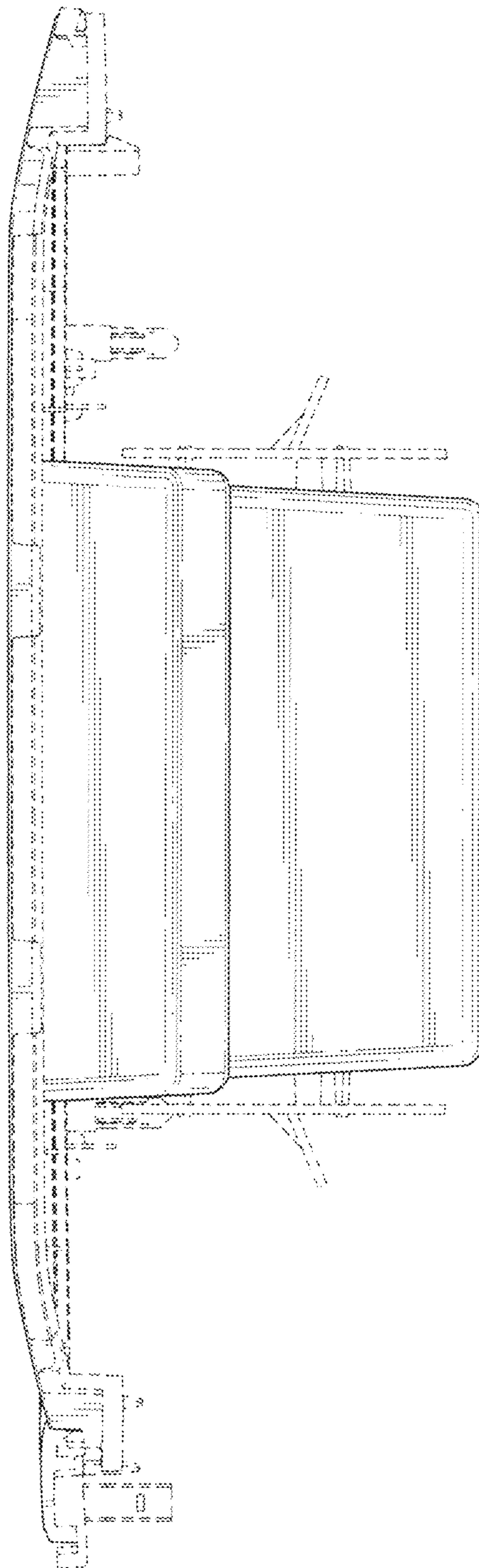

FIG. 7

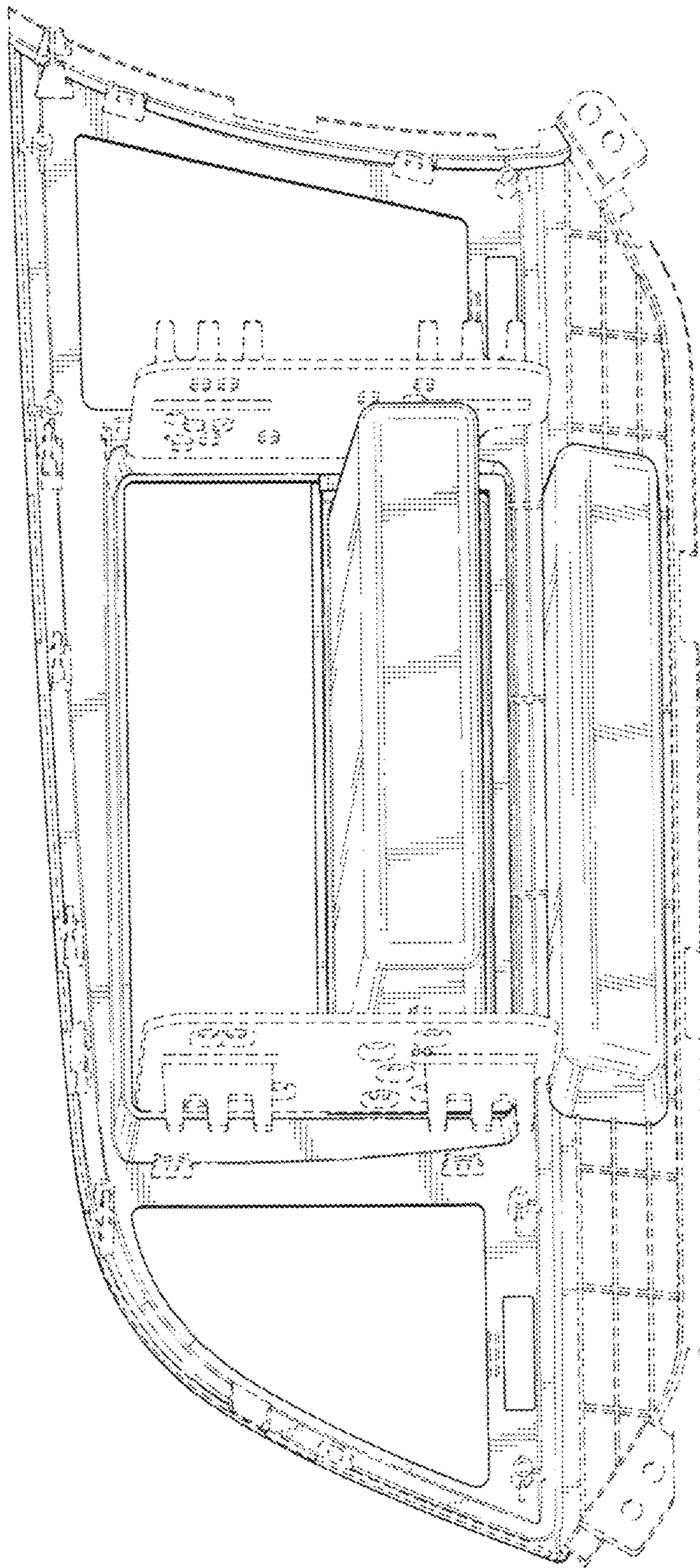

FIG. 8