



US00D830988S

(12) **United States Design Patent**
Porzelt et al.

(10) **Patent No.:** **US D830,988 S**

(45) **Date of Patent:** **** Oct. 16, 2018**

(54) **INTERCOMMUNICATION SYSTEM**

(71) Applicant: **Siemens Healthcare GmbH**, Erlangen (DE)

(72) Inventors: **Klaus Porzelt**, Nuremberg (DE); **Steffen Schroeter**, Fuerth (DE); **Jens Thoene**, Lauf an der Pegnitz (DE)

(73) Assignee: **Siemens Healthcare GmbH**, Erlangen (DE)

(**) Term: **15 Years**

(21) Appl. No.: **29/604,526**

(22) Filed: **May 18, 2017**

(30) **Foreign Application Priority Data**

Nov. 21, 2016 (EM) 003474683

(51) **LOC (11) Cl.** **14-03**

(52) **U.S. Cl.**
USPC **D14/159**

(58) **Field of Classification Search**

USPC D14/167, 154, 168, 188, 496, 156, 160, D14/161, 162, 163, 164, 165, 158, 253, D14/192, 159, 155, 138 AB, 137, 104.1; 455/351, 350, 353; D10/104, 106, 65, D10/78; 340/573.4, 573.1
CPC G08B 13/1672; G08B 13/19645; G08B 25/006; H04M 11/04

See application file for complete search history.

(56) **References Cited**

U.S. PATENT DOCUMENTS

D365,562 S * 12/1995 Abrams D14/159
D409,511 S * 5/1999 Ames D14/159

D424,958 S * 5/2000 Nowak D10/104.1
D538,245 S * 3/2007 Heath D14/137
D539,252 S * 3/2007 Heath D14/137
D579,913 S * 11/2008 Lamason D14/159
D649,135 S * 11/2011 Hocherman D14/159
D665,767 S * 8/2012 Hancock D14/159
D666,988 S * 9/2012 Meurer D14/159
D689,037 S * 9/2013 Sumi D14/159
D735,690 S * 8/2015 Sharp D14/159
D752,012 S * 3/2016 Takahata D14/142
D761,753 S * 7/2016 Michielan D14/159
D772,837 S * 11/2016 Larson D14/159
D789,905 S * 6/2017 Liu D14/159
D795,833 S * 8/2017 Zhou D14/159
D800,686 S * 10/2017 Hinkel D14/159

* cited by examiner

Primary Examiner — Austin Murphy

(74) *Attorney, Agent, or Firm* — Schiff Hardin LLP

(57) **CLAIM**

The ornamental design for an intercommunication system, as shown and described.

DESCRIPTION

FIG. 1 is a front elevational view of an intercommunication system showing our new design; FIG. 2 is a back elevational view thereof; FIG. 3 is a top plan view thereof; FIG. 4 is a bottom plan view thereof; FIG. 5 is a right side elevational view thereof; FIG. 6 is a left side elevational view thereof; and, FIG. 7 is a perspective view taken generally from the top, front, left-hand side thereof.

High-quality electronic copies of the drawings are available in the Office's electronic record of this application.

1 Claim, 7 Drawing Sheets

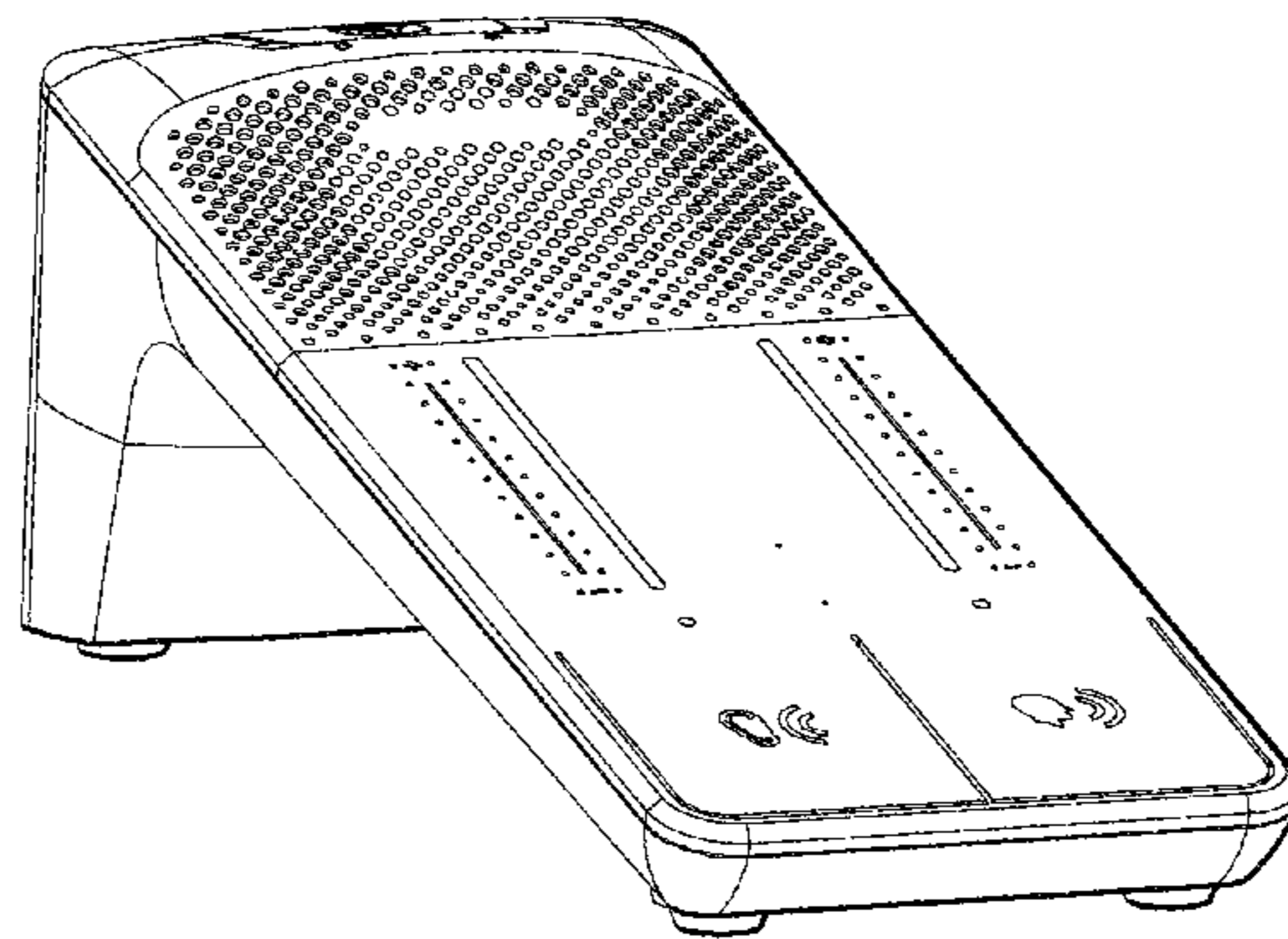
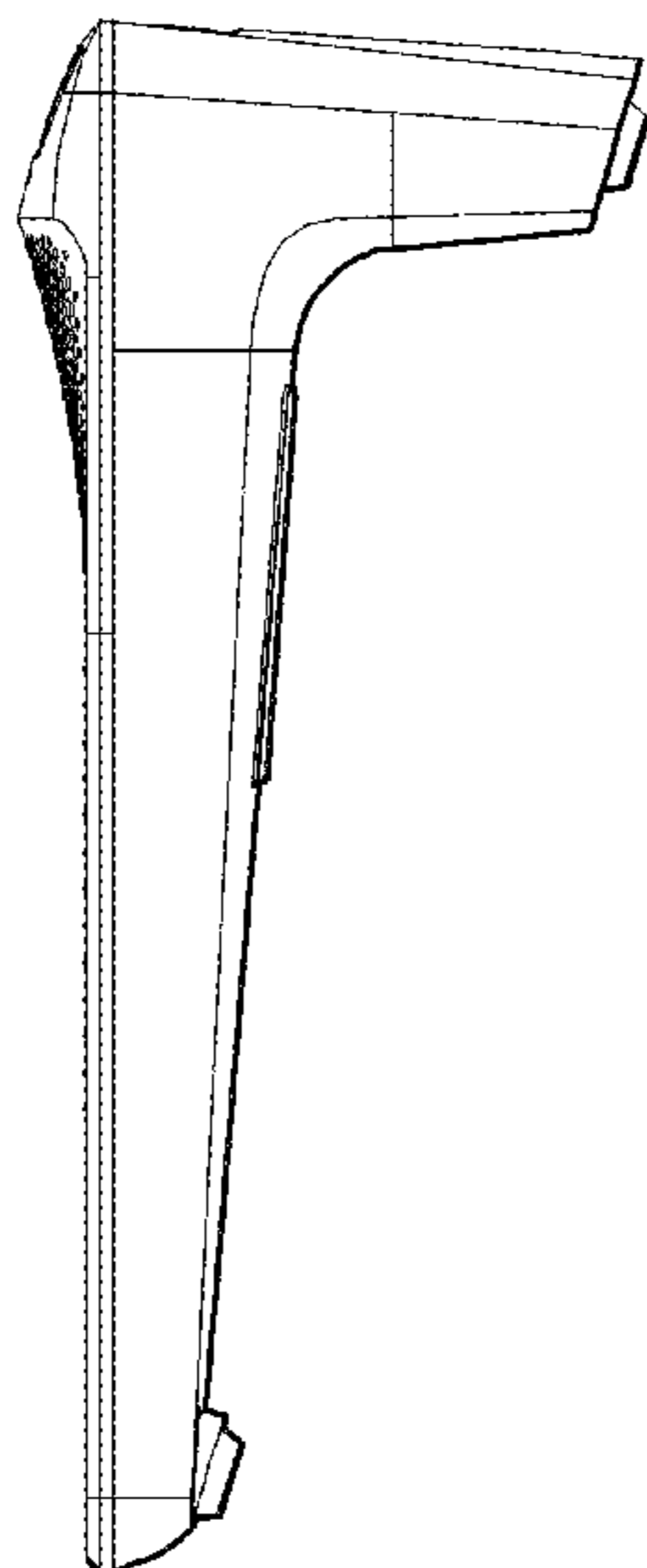

FIG. 1

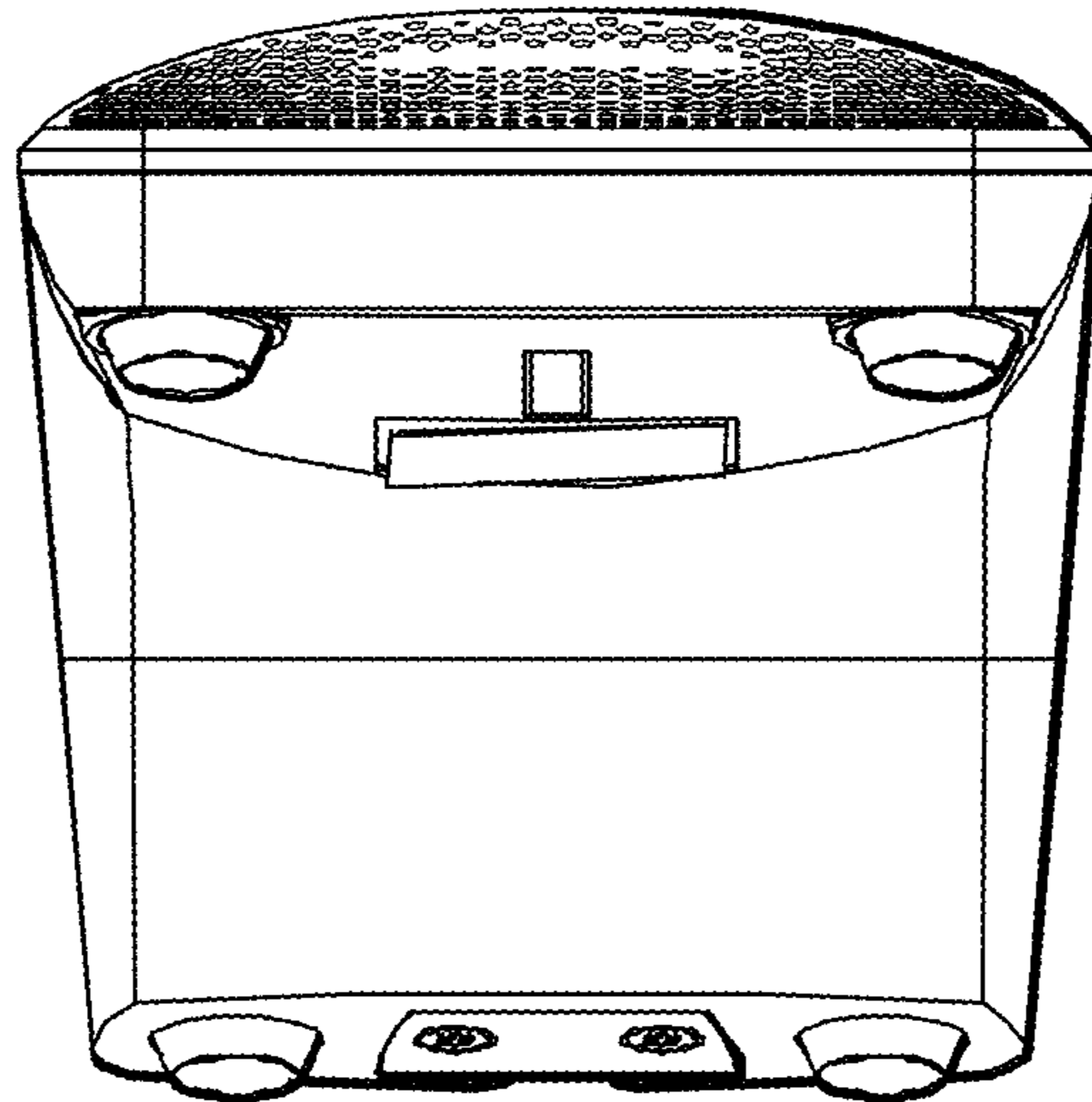

FIG. 2

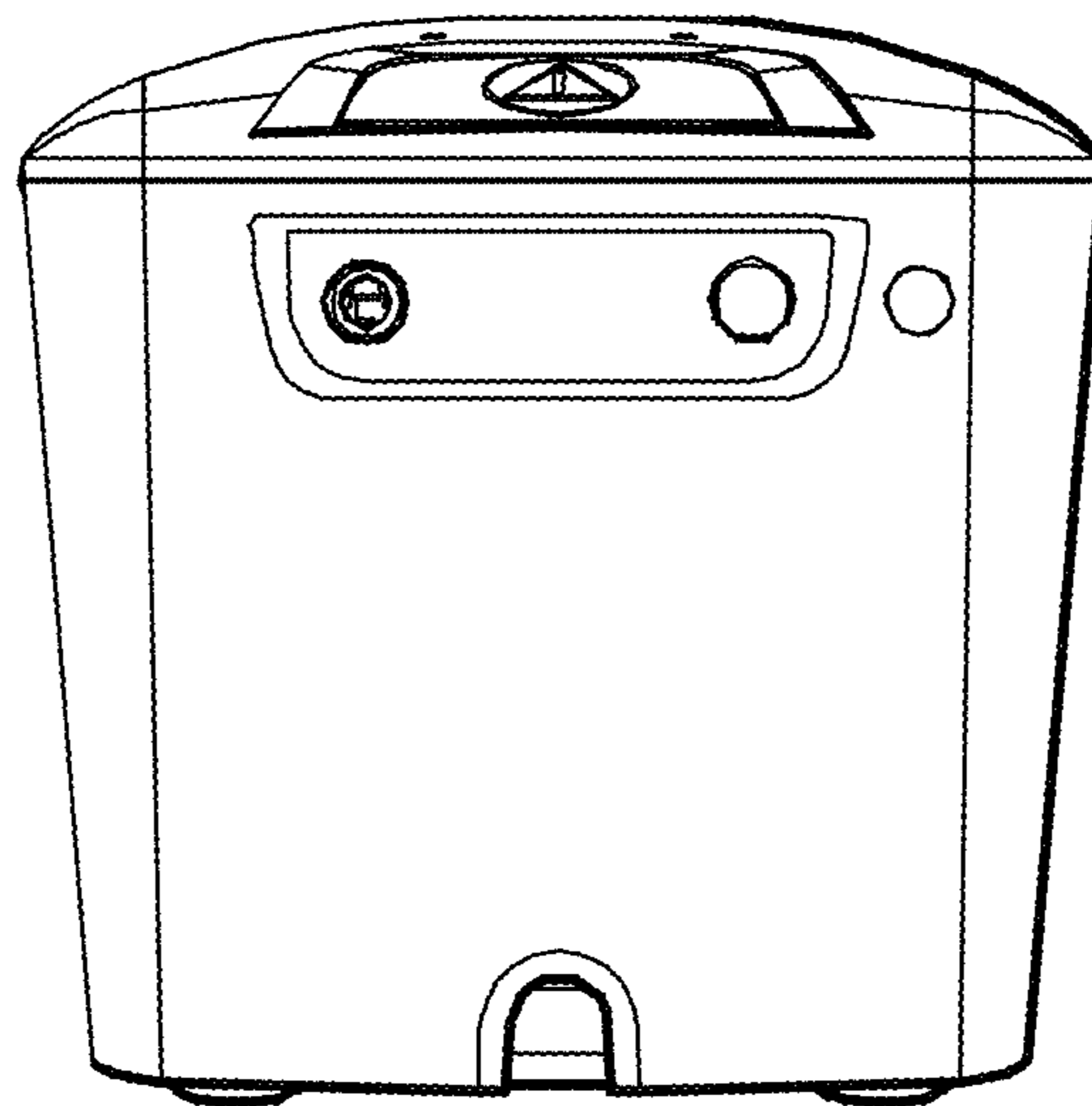

FIG. 3

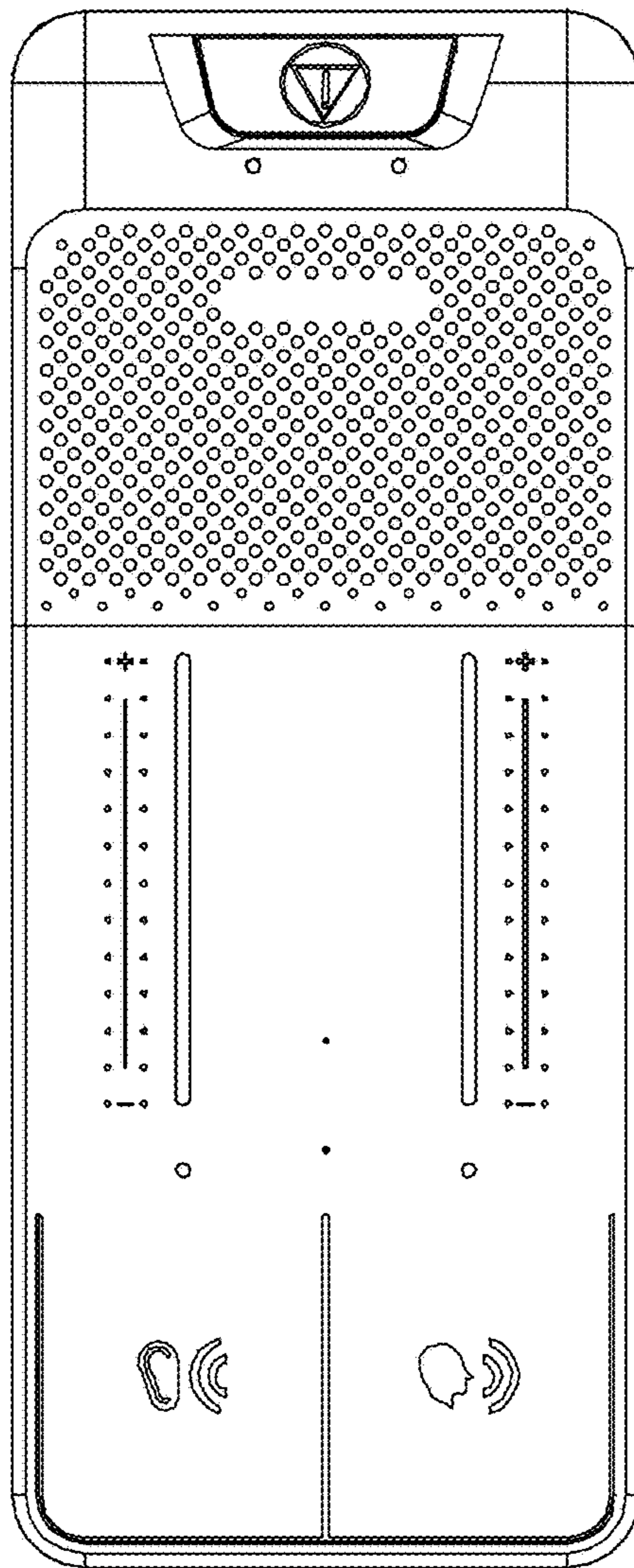

FIG. 4

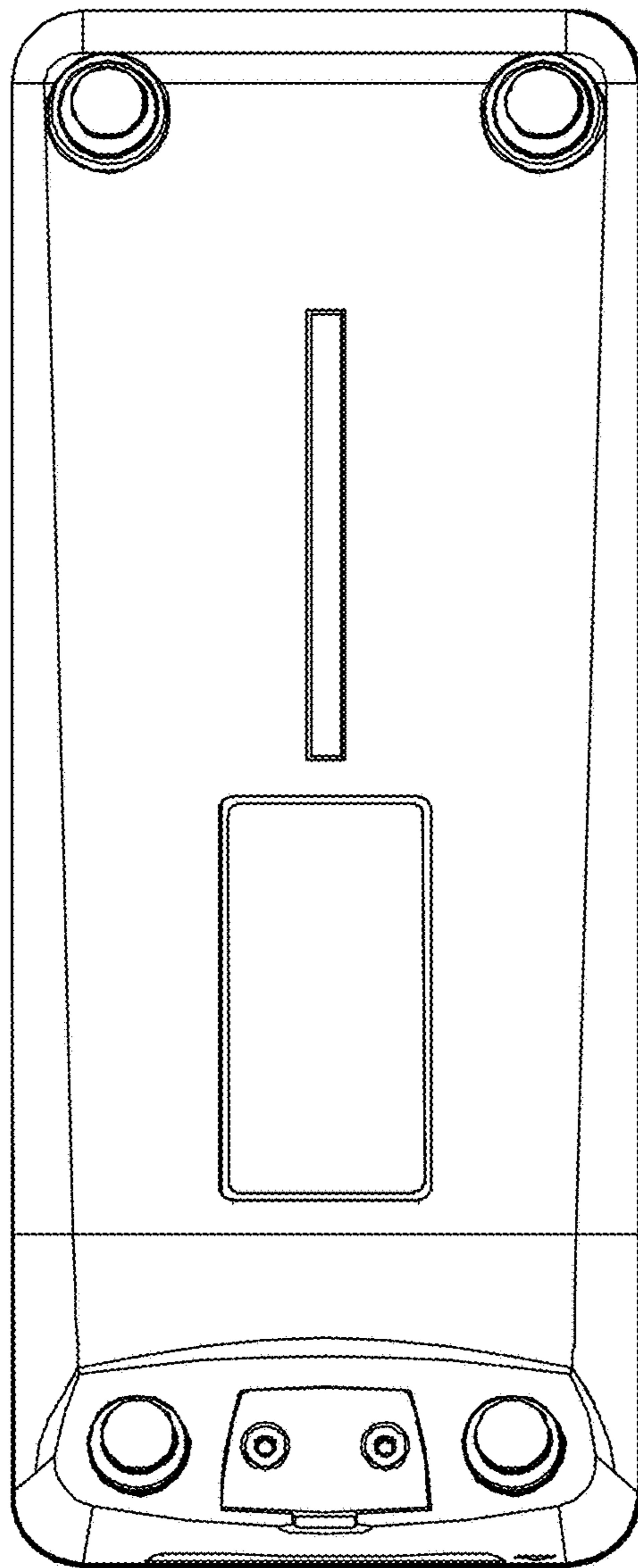

FIG. 5

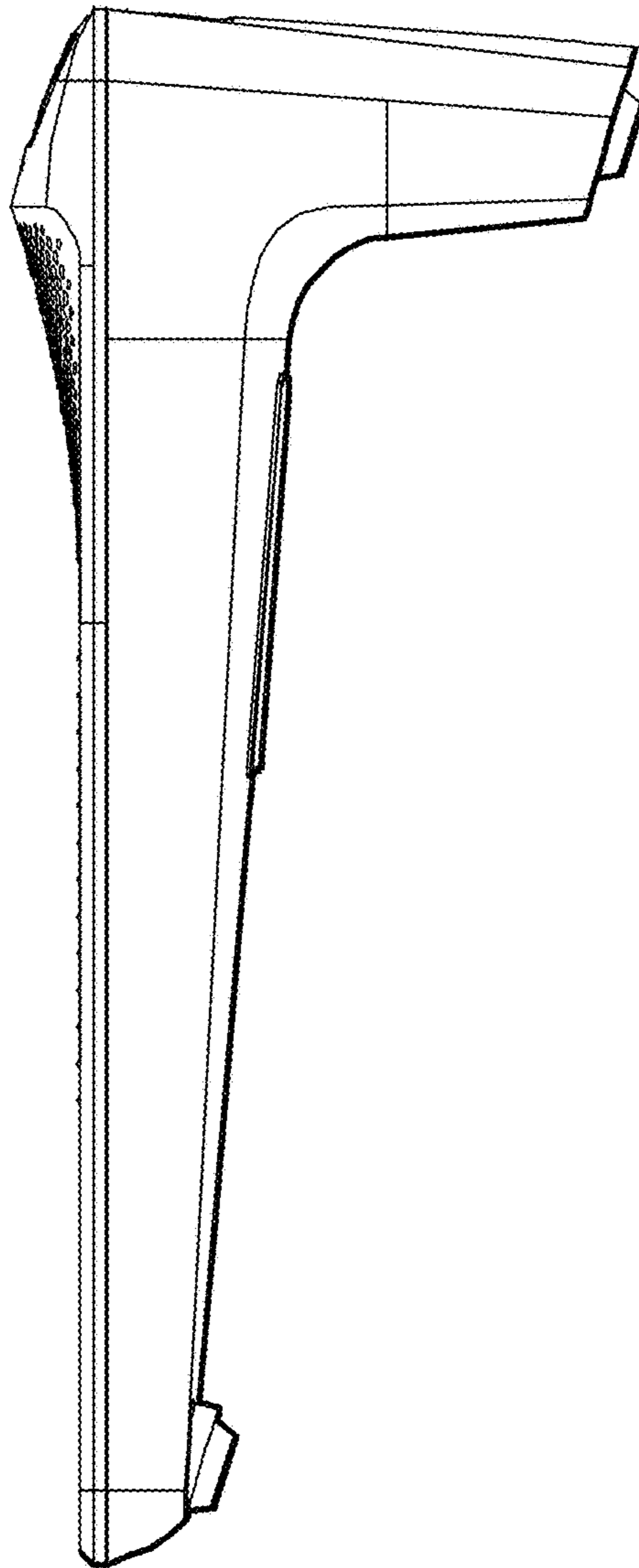

FIG. 6

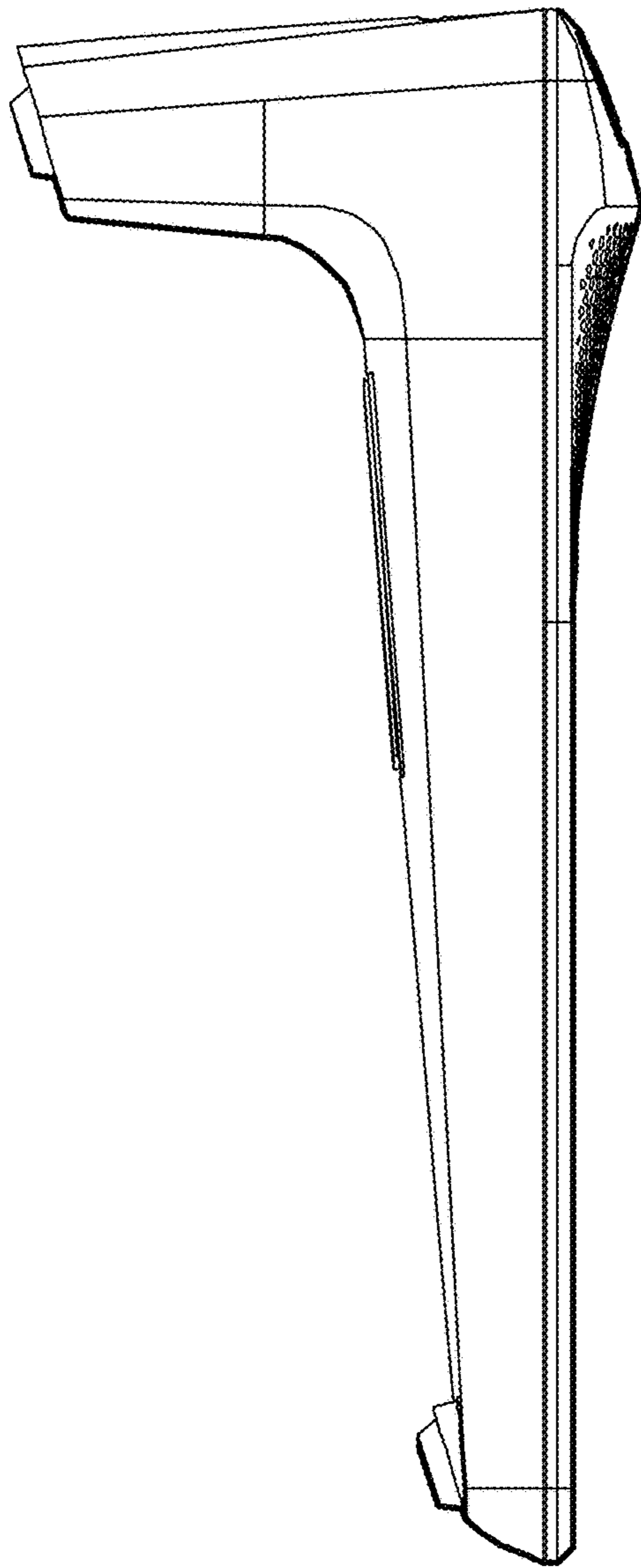

FIG. 7

