



US00D830922S

(12) **United States Design Patent**
Chuengviroj

(10) **Patent No.:** **US D830,922 S**

(45) **Date of Patent:** **** Oct. 16, 2018**

- (54) **BUMPER**
- (71) Applicant: **ALL CORPORATION LIMITED**,
Bangkok Metropolis (TH)
- (72) Inventor: **Vichien Chuengviroj**, Bangkok
Metropolis (TH)
- (73) Assignee: **ALL CORPORATION LIMITED**,
Bangkok Metropolis (TH)

6,398,276 B1 *	6/2002	Smith	B60R 19/44
				293/115
7,338,100 B2 *	3/2008	Meyer	B60R 19/44
				150/166
D576,526 S *	9/2008	McBain	D12/162
7,874,572 B2 *	1/2011	Buehler	B60D 1/167
				280/451
D689,417 S *	9/2013	Shelters	D12/171
D709,806 S *	7/2014	Musgrove	D12/167
2012/0187704 A1 *	7/2012	Gibbs	B60R 19/46
				293/142

(**) Term: **15 Years**

* cited by examiner

(21) Appl. No.: **29/596,891**

Primary Examiner — Darlington Ly

(22) Filed: **Mar. 13, 2017**

(74) *Attorney, Agent, or Firm* — Marshall, Gerstein & Borun LLP

(51) **LOC (11) Cl.** **12-16**

(52) **U.S. Cl.**
USPC **D12/171**

(58) **Field of Classification Search**
USPC D12/86, 90, 91, 92, 163, 164, 167, 169,
D12/171, 196, 216
CPC B60R 19/02; B60R 19/18; B60R 19/24;
B60R 19/44; B60R 19/56; B60R
2019/007
See application file for complete search history.

(57) **CLAIM**

The ornamental design for a bumper, as shown.

DESCRIPTION

FIG. 1 is a top, right-side, and front view of a bumper, showing the new design.
FIG. 2 is a top plan view of the bumper.
FIG. 3 is a front elevation view of the bumper.
FIG. 4 is a right-side elevation view of the bumper.
FIG. 5 is a rear elevation view of the bumper.
FIG. 6 is a left-side elevation view of the bumper; and,
FIG. 7 is a bottom plan view of the bumper.

(56) **References Cited**

U.S. PATENT DOCUMENTS

5,570,826 A *	11/1996	Garbes	B60R 9/06
				224/518
5,775,560 A *	7/1998	Zahn	B60R 9/06
				224/485

1 Claim, 3 Drawing Sheets

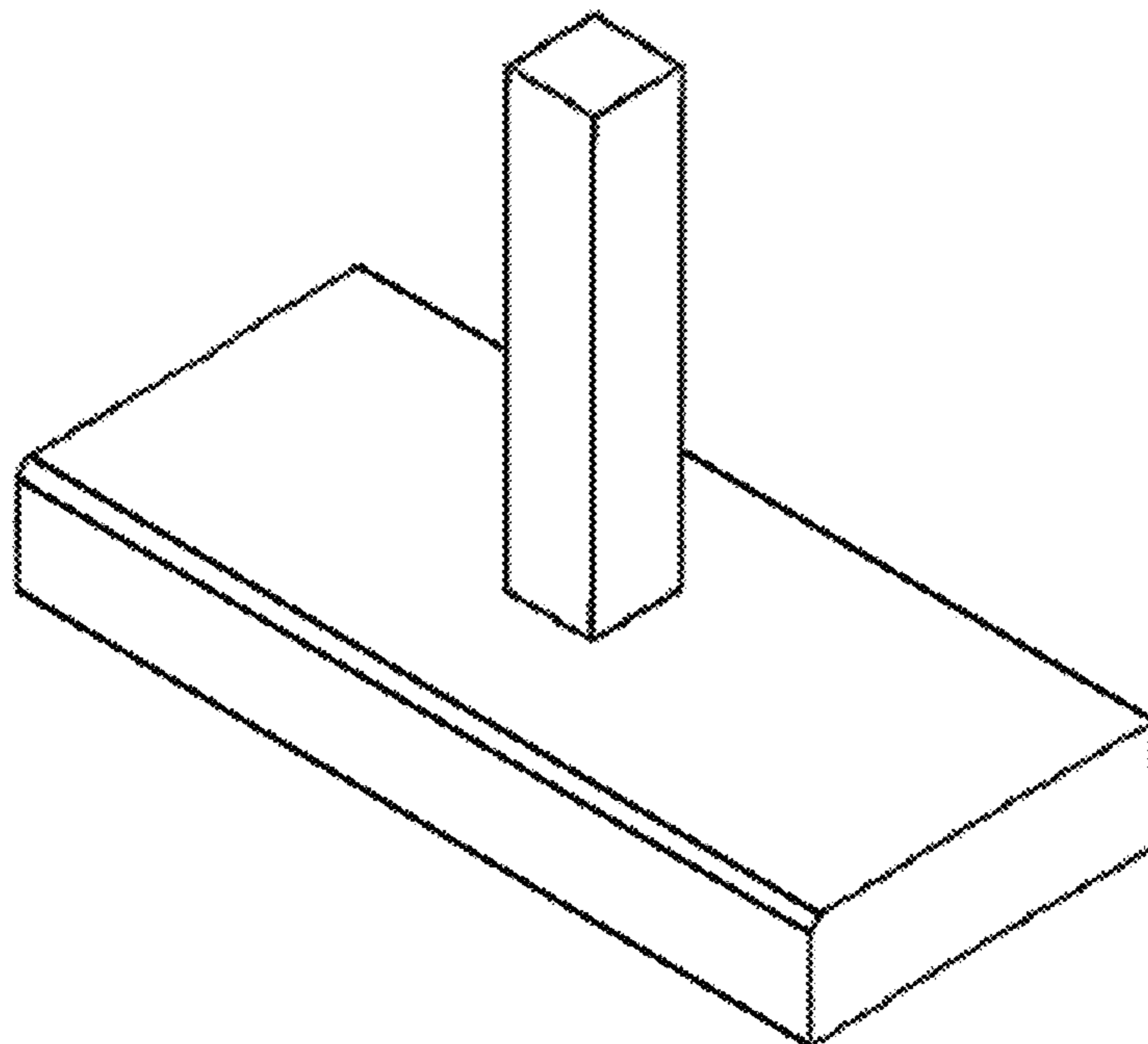

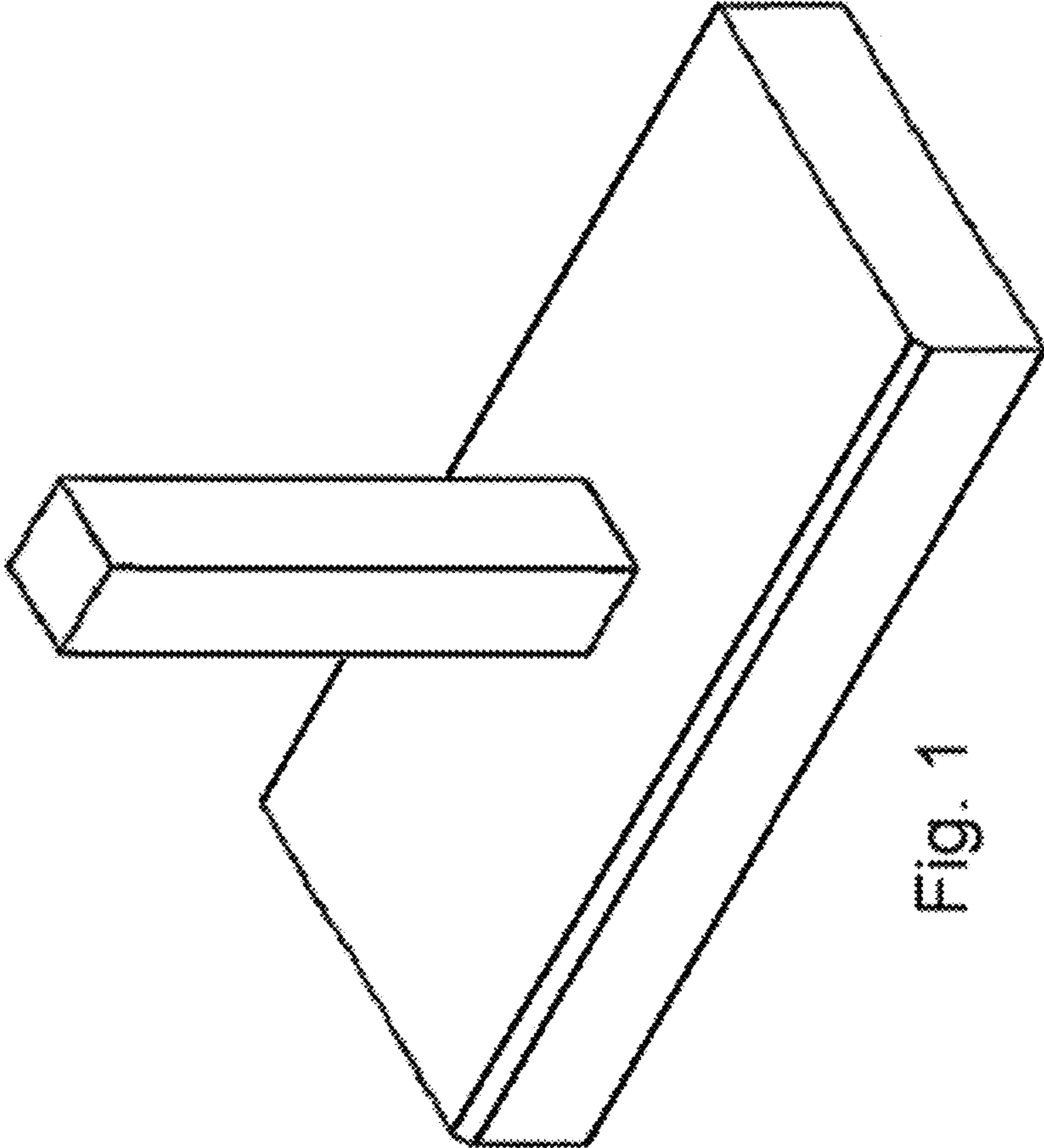

Fig. 1

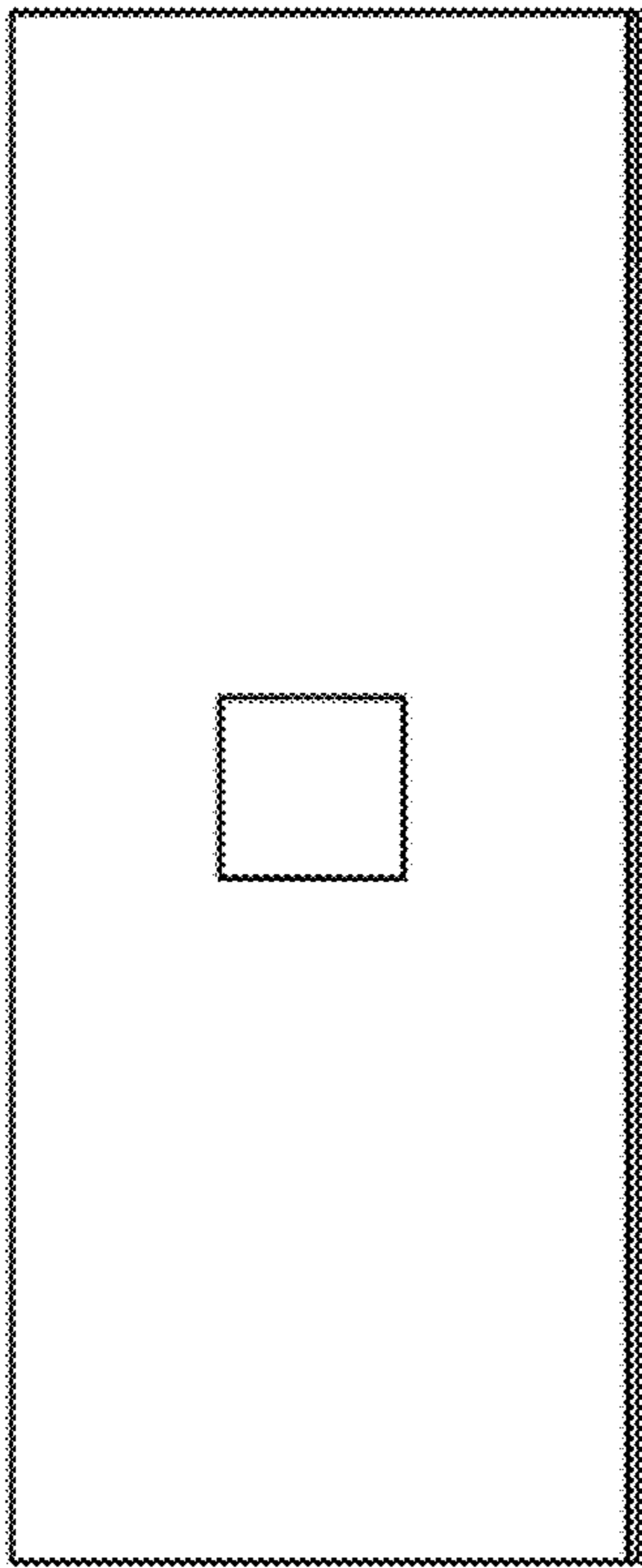

Fig. 2

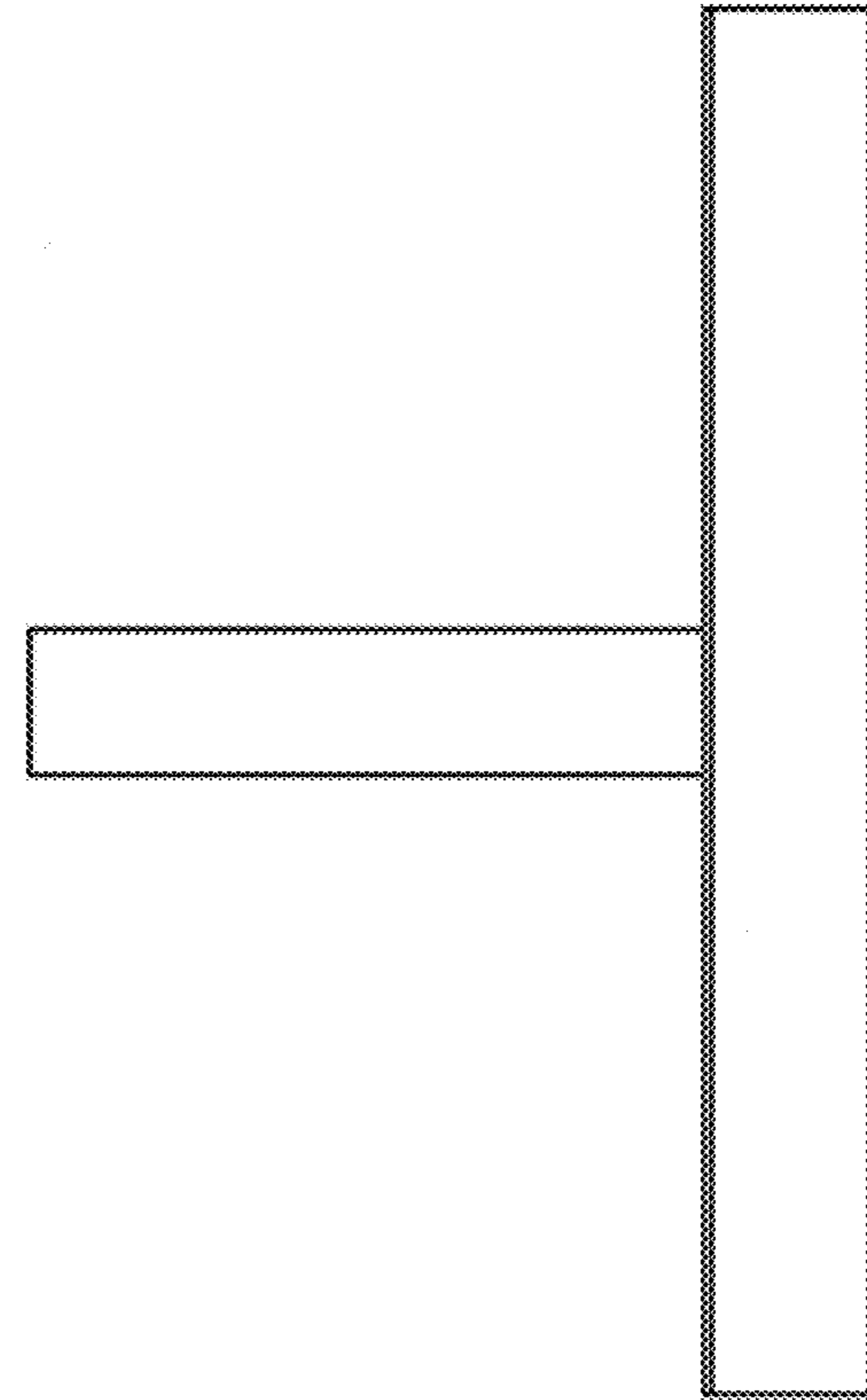

Fig. 3

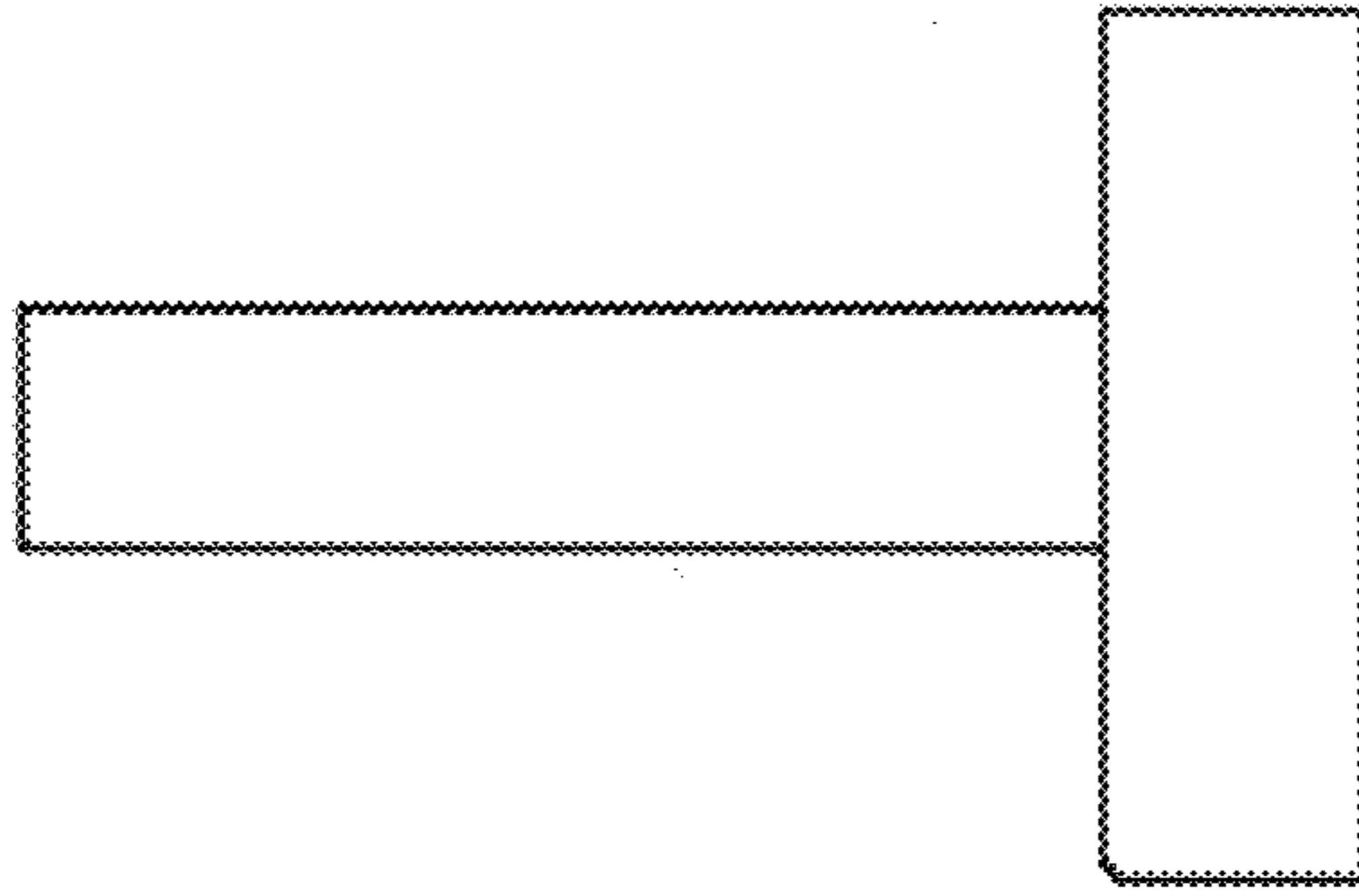

Fig. 4

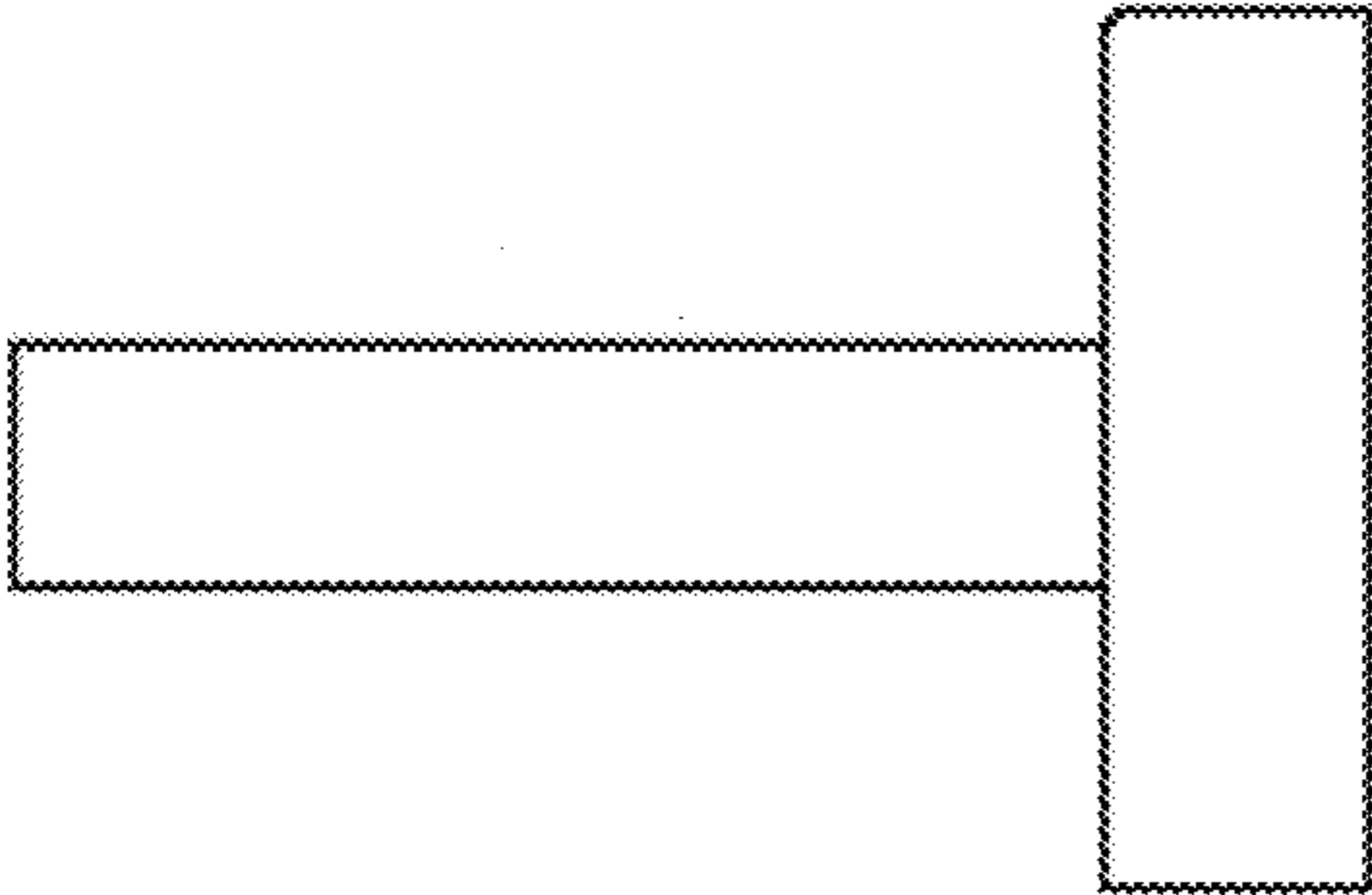

Fig. 6

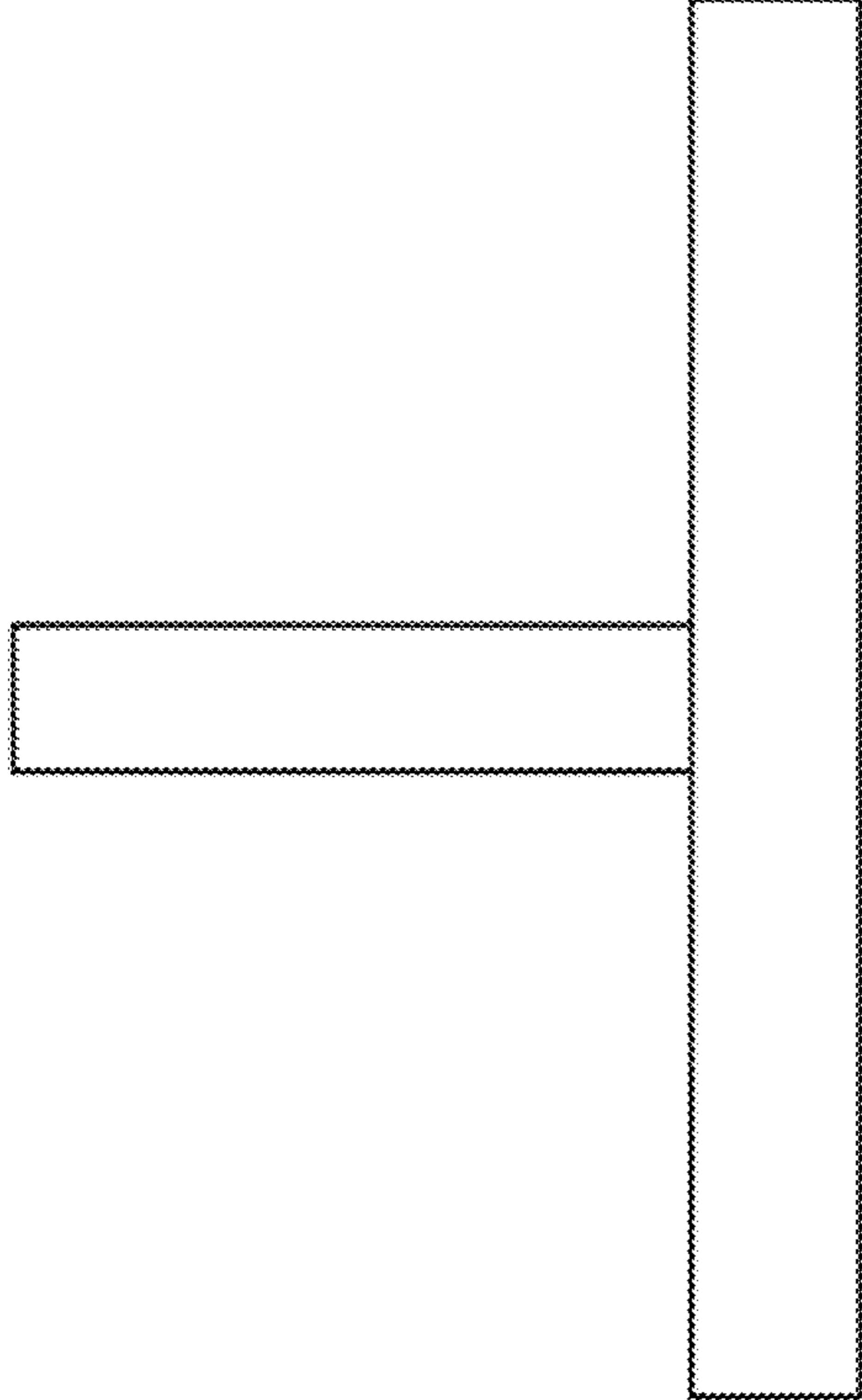

Fig. 5

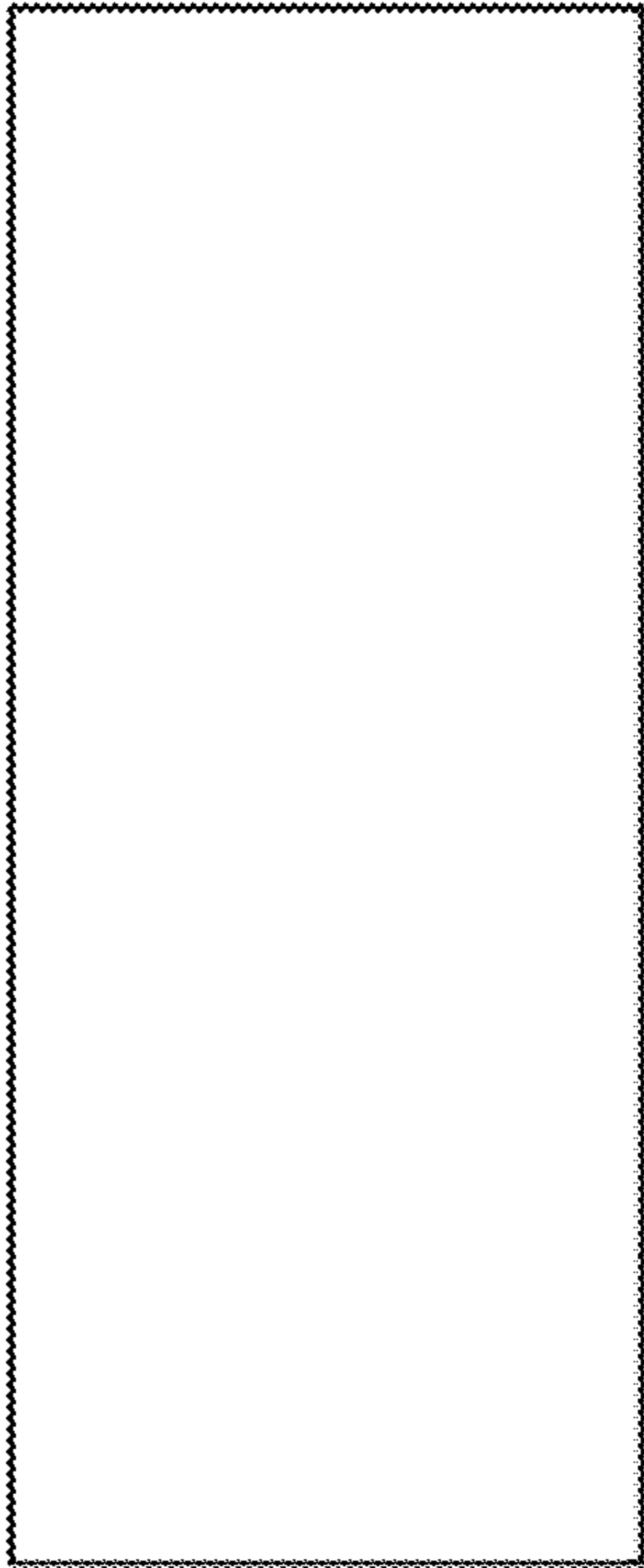

Fig. 7