



US00D830849S

(12) **United States Design Patent** (10) **Patent No.:** **US D830,849 S**  
**Tan** (45) **Date of Patent:** **\*\* Oct. 16, 2018**

- (54) **SEALABLE PAPER BAG**
- (71) Applicant: **Pan Pacific Plastics Mfg., Inc.**,  
Hayward, CA (US)
- (72) Inventor: **Hin Siang Michael Tan**, Danville, CA  
(US)
- (73) Assignee: **PAN PACIFIC PLASTICS MFG.,  
INC.**, Hayward, CA (US)
- (\*\*) Term: **15 Years**
- (21) Appl. No.: **29/604,254**
- (22) Filed: **May 16, 2017**
- (51) **LOC (11) Cl.** ..... **09-05**
- (52) **U.S. Cl.**  
USPC ..... **D9/705**
- (58) **Field of Classification Search**  
USPC ..... D9/702-714, 719, 738-740, 517-518,  
D9/522, 416, 435, 444, 460, 455, 414,  
(Continued)

- (56) **References Cited**  
  
U.S. PATENT DOCUMENTS  
  
D47,085 S \* 3/1915 Veith ..... 206/216  
D225,311 S \* 12/1972 Harrison ..... D9/703  
(Continued)

*Primary Examiner* — Abraham Bahta  
(74) *Attorney, Agent, or Firm* — Beyer Law Group LLP

(57) **CLAIM**  
I claim the ornamental design for a sealable paper bag,  
substantially as shown and described.

**DESCRIPTION**

FIG. 1 is a front perspective view of the sealable paper bag  
showing my new design;  
FIG. 2 is a front perspective view thereof, the bag shown in  
a sealed condition;

FIG. 3 is a front perspective view thereof, the bag shown in  
another sealed condition;  
FIG. 4 is a front perspective view of FIG. 3, the bag shown  
in another sealed condition;  
FIG. 5 is a rear perspective view of FIG. 4;  
FIG. 6 is a rear perspective view of FIG. 5, the sealable  
portion of the bag shown in a partially peeled condition;  
FIG. 7 is a rear perspective view of FIG. 2.  
FIG. 8 is a right side view of FIG. 3, the left side view being  
a mirror image thereof;  
FIG. 9 is a right side view of FIG. 4, the circular arrow  
illustrating a clockwise direction of a first fold over, the left  
side view being a mirror image thereof;  
FIG. 10 is a right side view thereof, the sealable portion of  
the bag shown in a partially peeled condition, the left side  
view being a mirror image thereof;  
FIG. 11 is a right side view thereof, the bag shown in another  
sealed condition, the circular arrow illustrating a clockwise  
direction of a second fold over, the left side view being a  
mirror image thereof;  
FIG. 12 is a right side view thereof, the bag shown in another  
sealed condition, the left side view being a mirror image  
thereof;  
FIG. 13 is a front view of FIG. 1;  
FIG. 14 is a rear view thereof;  
FIG. 15 is a right side view, the left side view being a mirror  
image thereof;  
FIG. 16 is a top view thereof;  
FIG. 17 is a bottom view thereof;  
FIG. 18 is a front view of an upper portion of FIG. 1;  
FIG. 19 is a rear view thereof;  
FIG. 20 is a right side view, the left side view being a mirror  
image thereof;  
FIG. 21 is a top view thereof; and,  
FIG. 22 is a bottom view thereof.  
The broken lines in the Figures show portions of the sealable  
paper bag which form no part of the claimed design.  
The shade lines in the Figures show contours and not surface  
ornamentation. The break-away portion shown in FIGS. 18,  
19, 21 and 22 are included to show that the sealable paper  
bag has no specific length.

**1 Claim, 17 Drawing Sheets**

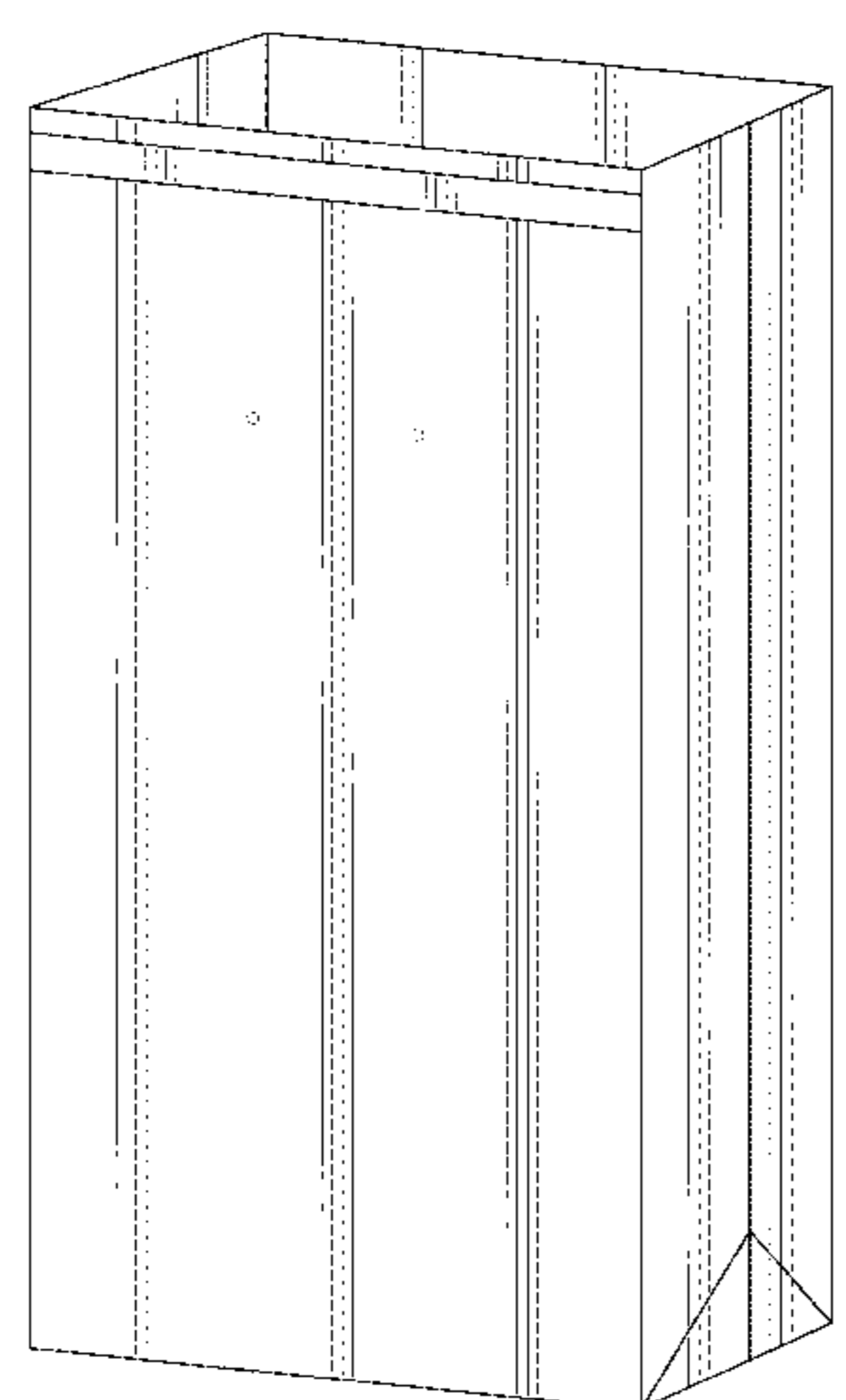

(58) **Field of Classification Search**

USPC ..... D9/499, 431–432; D7/560–562;  
206/434, 426–427, 429–430, 485, 485.1,  
206/499, 508, 431, 418–422, 588–594;  
229/117.3, 185, 121, 122, 200, 207, 236,  
229/87.01; 220/23.83; 150/100–118;  
294/137, 152; 383/6, 10, 14, 20, 40, 33,  
383/104–105, 117, 108, 120, 93, 121.1,  
383/127; 428/34.3  
CPC ..... B65D 33/00; B65D 33/06; B65D 33/065;  
B65D 33/14; B65D 33/1683; B65D  
33/12; B65D 31/00; B65D 31/04; B65D  
31/10; A45C 3/04; A45C 3/10

See application file for complete search history.

(56) **References Cited**

U.S. PATENT DOCUMENTS

D239,253 S \* 3/1976 Tiep ..... D9/707  
D286,016 S \* 10/1986 Addiego ..... D9/517  
D319,780 S \* 9/1991 Laaki ..... D9/707  
D349,451 S \* 8/1994 Sagnard ..... D9/703  
5,417,040 A \* 5/1995 Davoren ..... B65B 1/02  
206/554  
5,788,378 A \* 8/1998 Thomas ..... B65D 31/10  
383/104  
D501,134 S \* 1/2005 Takahashi ..... D9/703  
D584,165 S \* 1/2009 Kerr ..... D9/705  
D597,832 S \* 8/2009 Bischoff ..... D9/431  
D801,826 S \* 11/2017 O'Connor ..... D9/649  
2017/0001761 A1 \* 1/2017 Arcot ..... B65D 33/007

\* cited by examiner

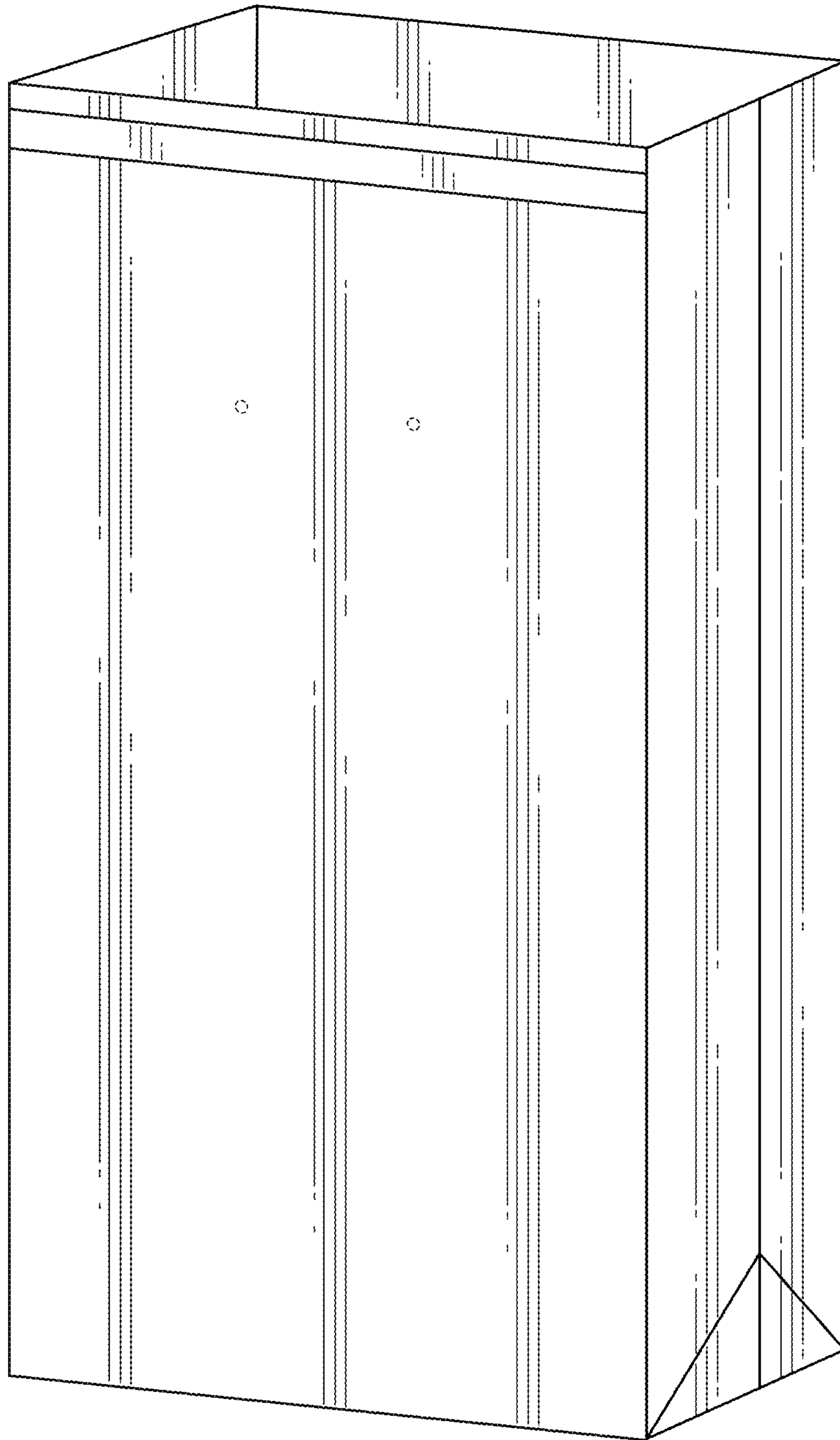

FIG. 1

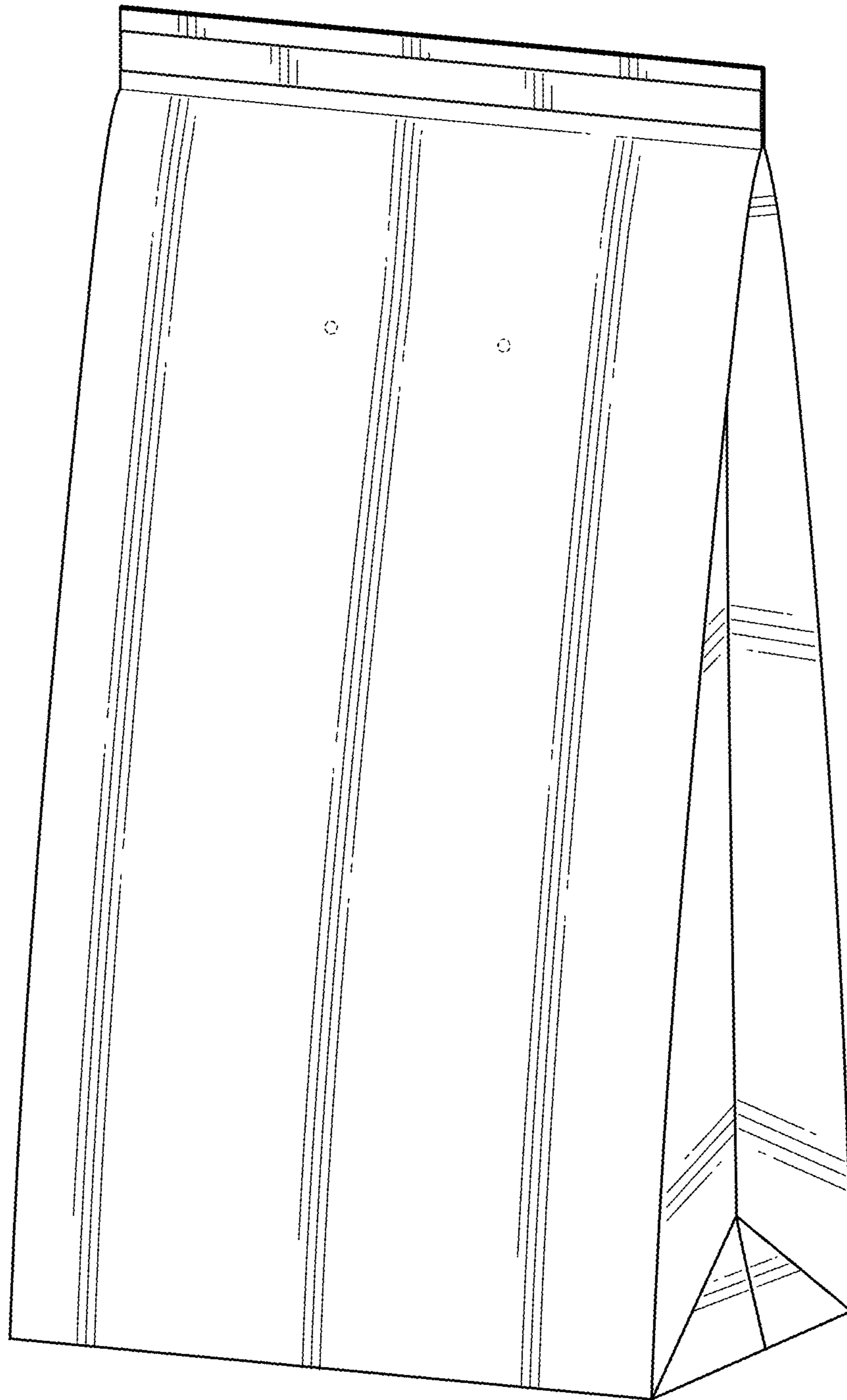

FIG. 2



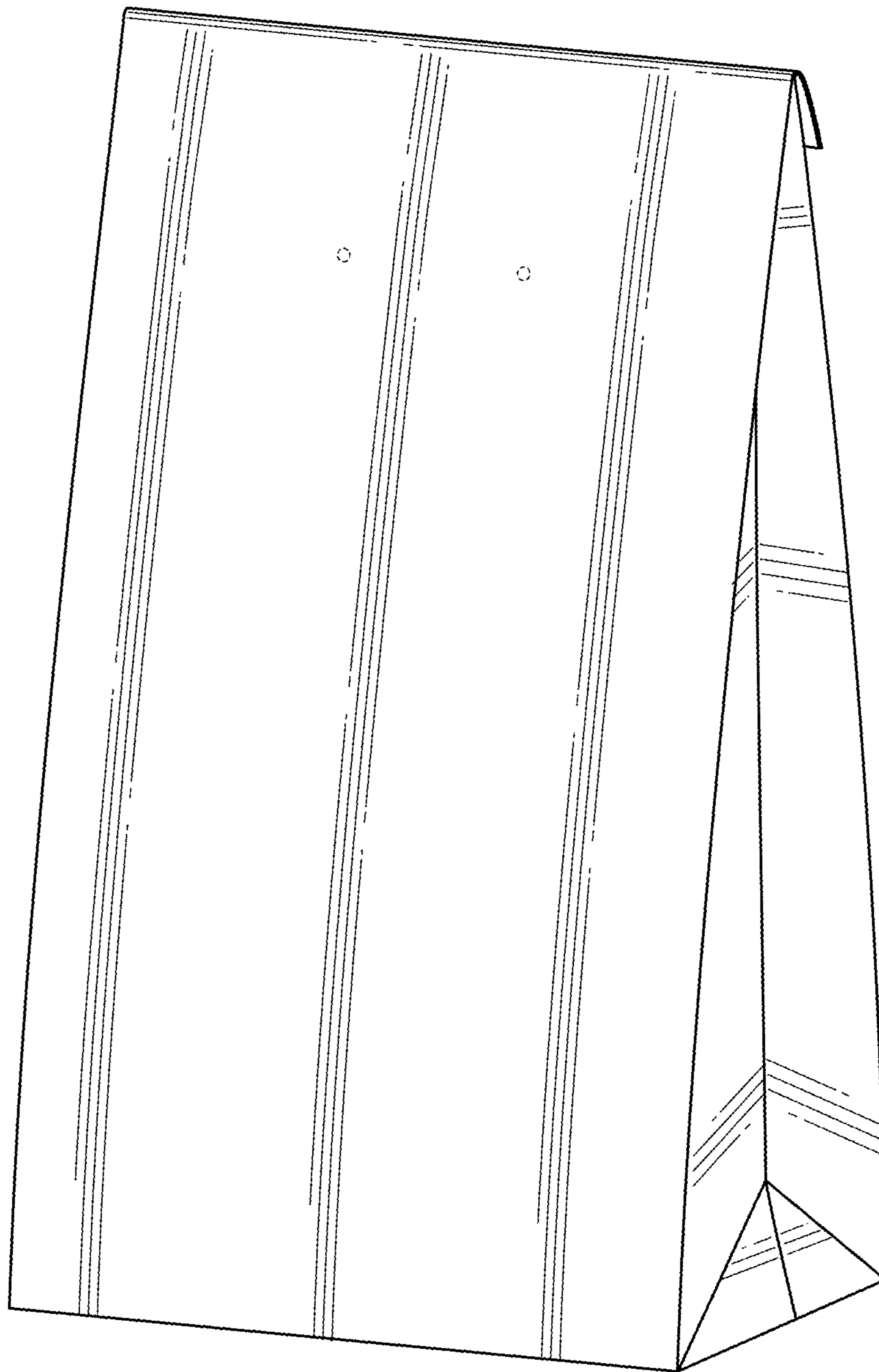

FIG. 3

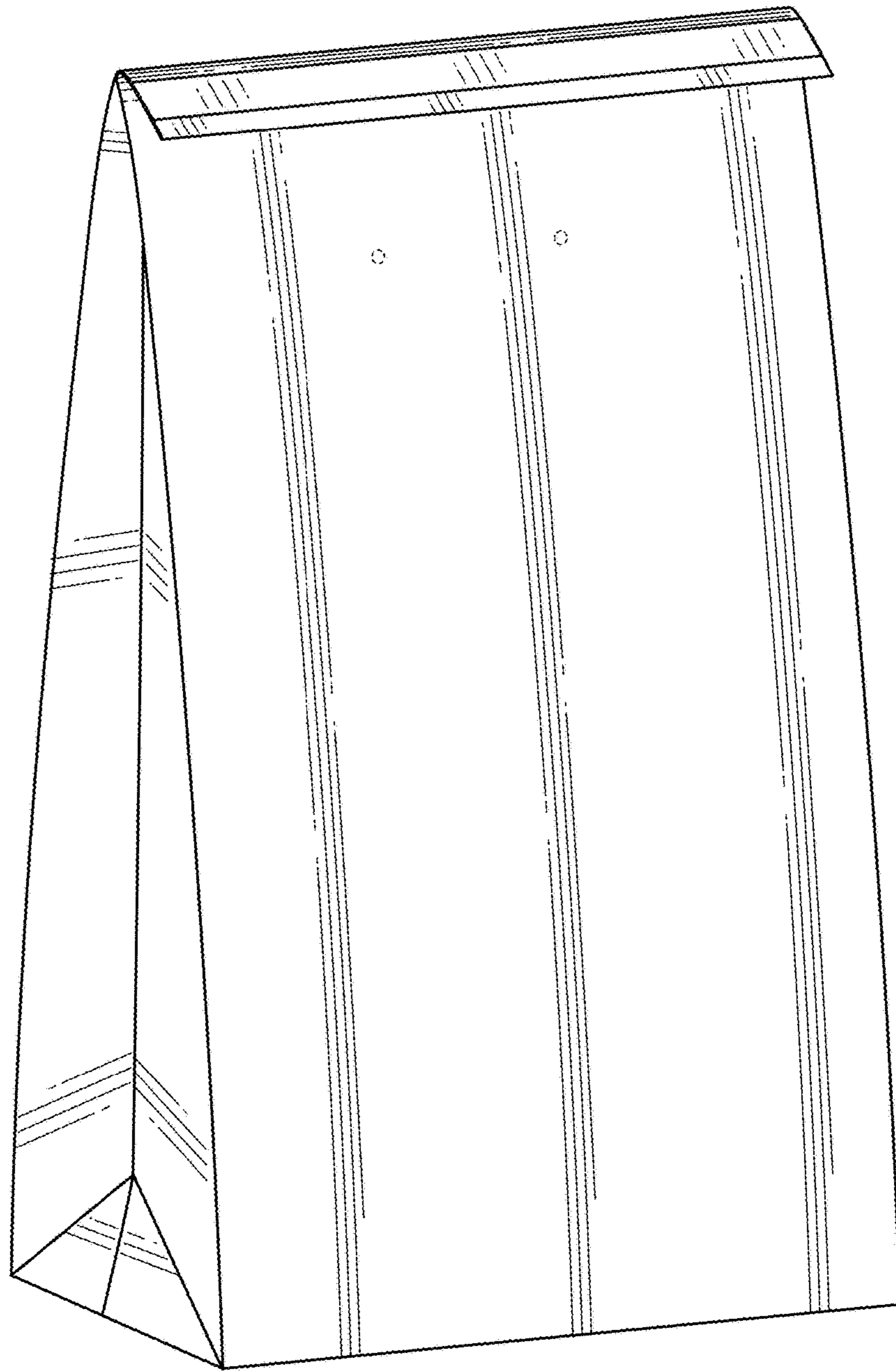

FIG. 4

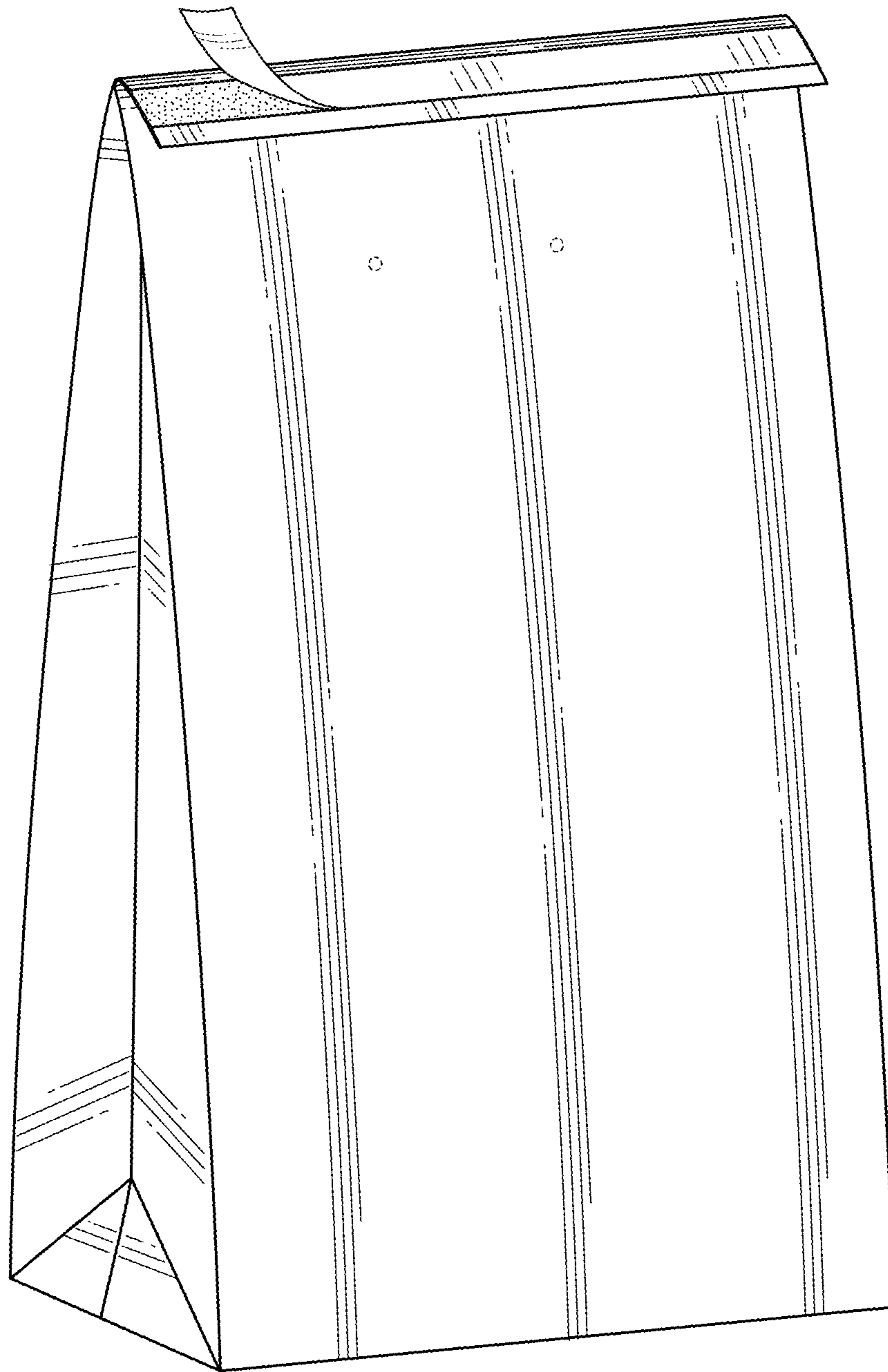

FIG. 5

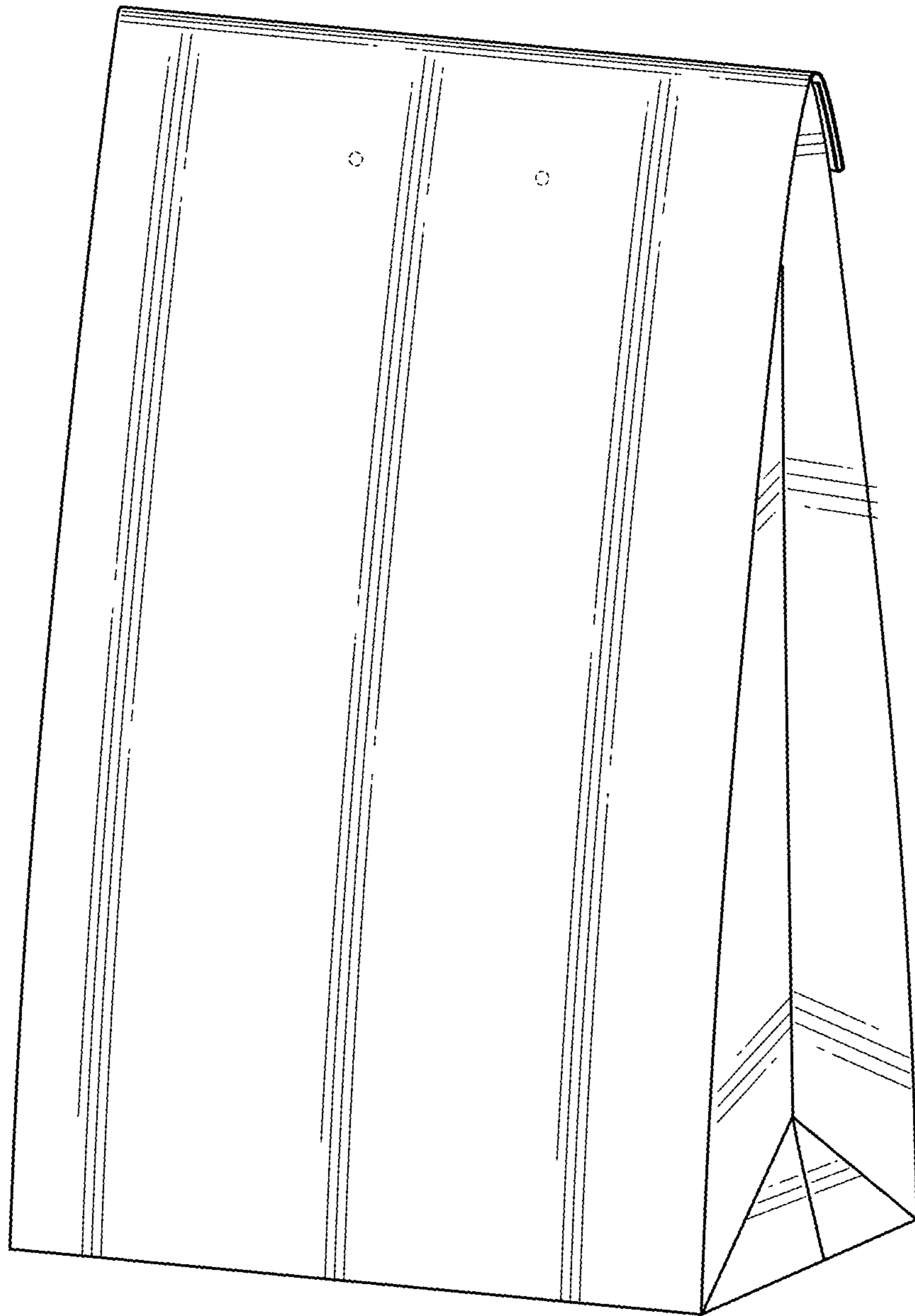

FIG. 6



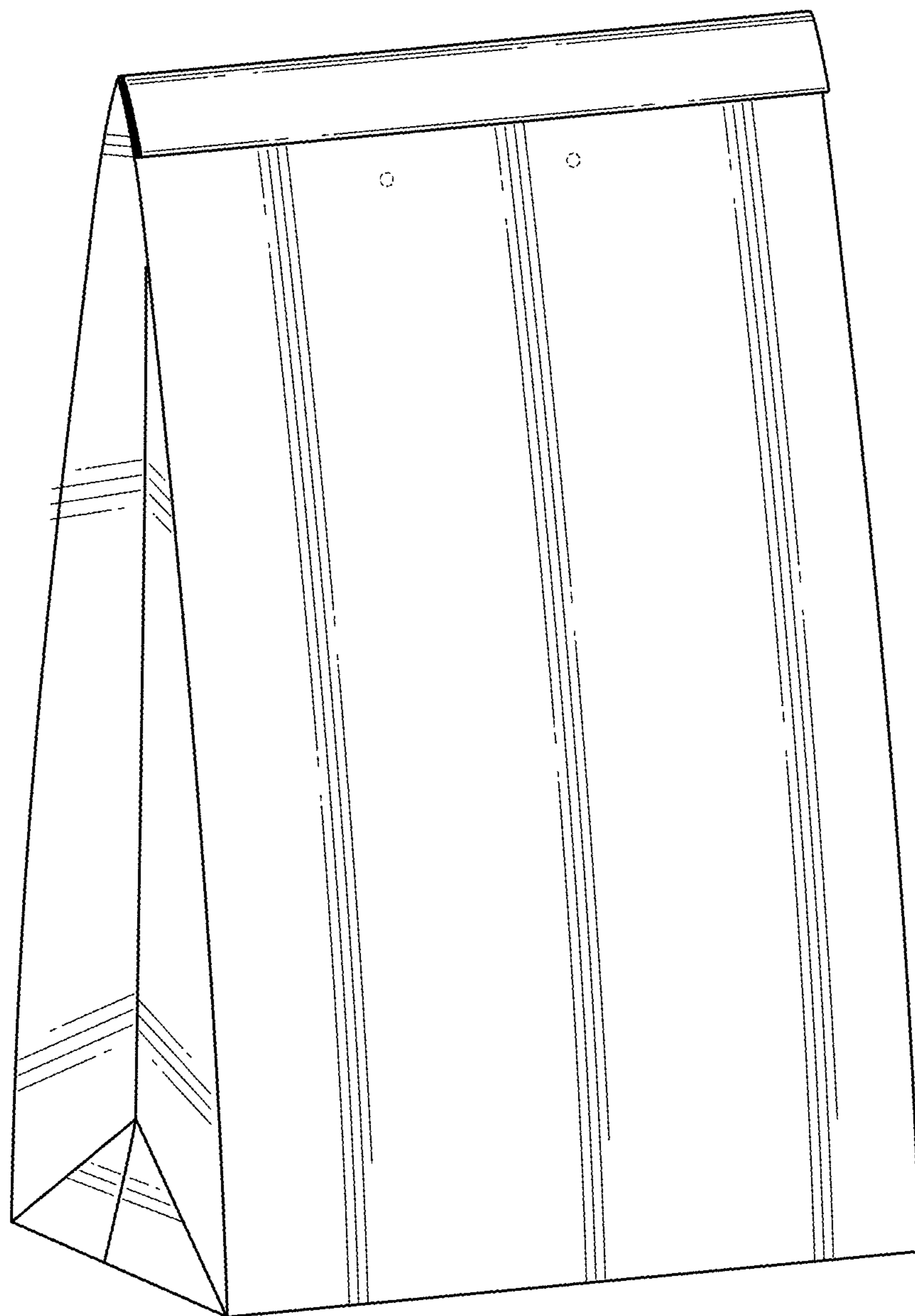

FIG. 7

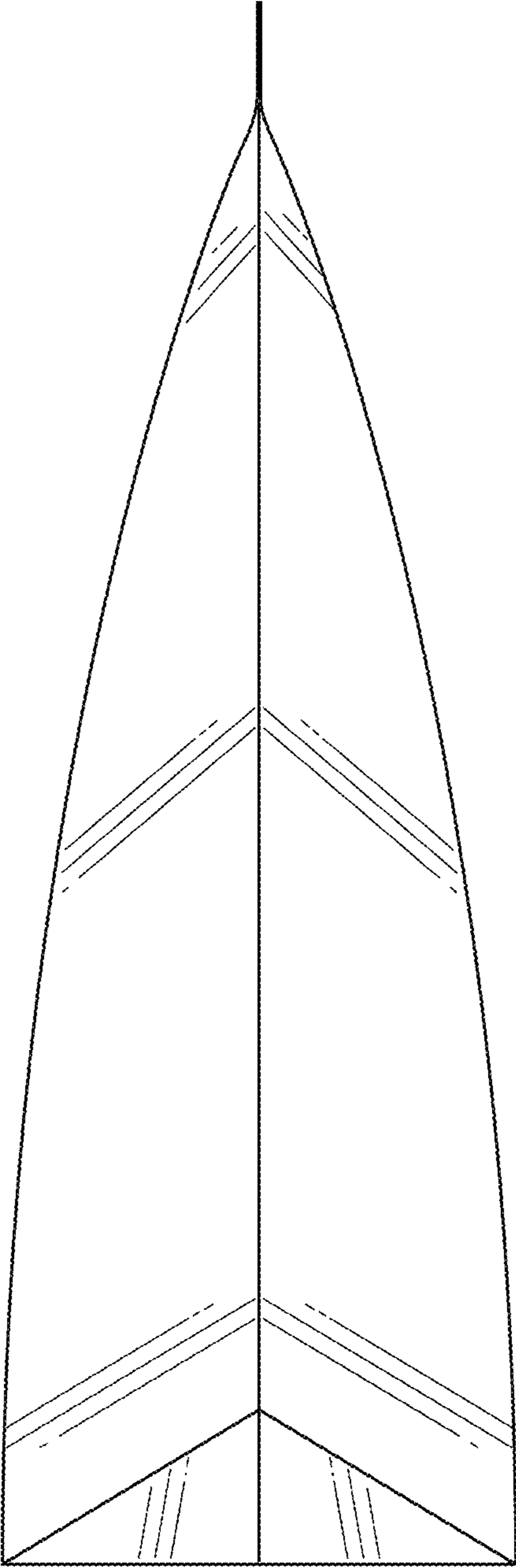

FIG. 8

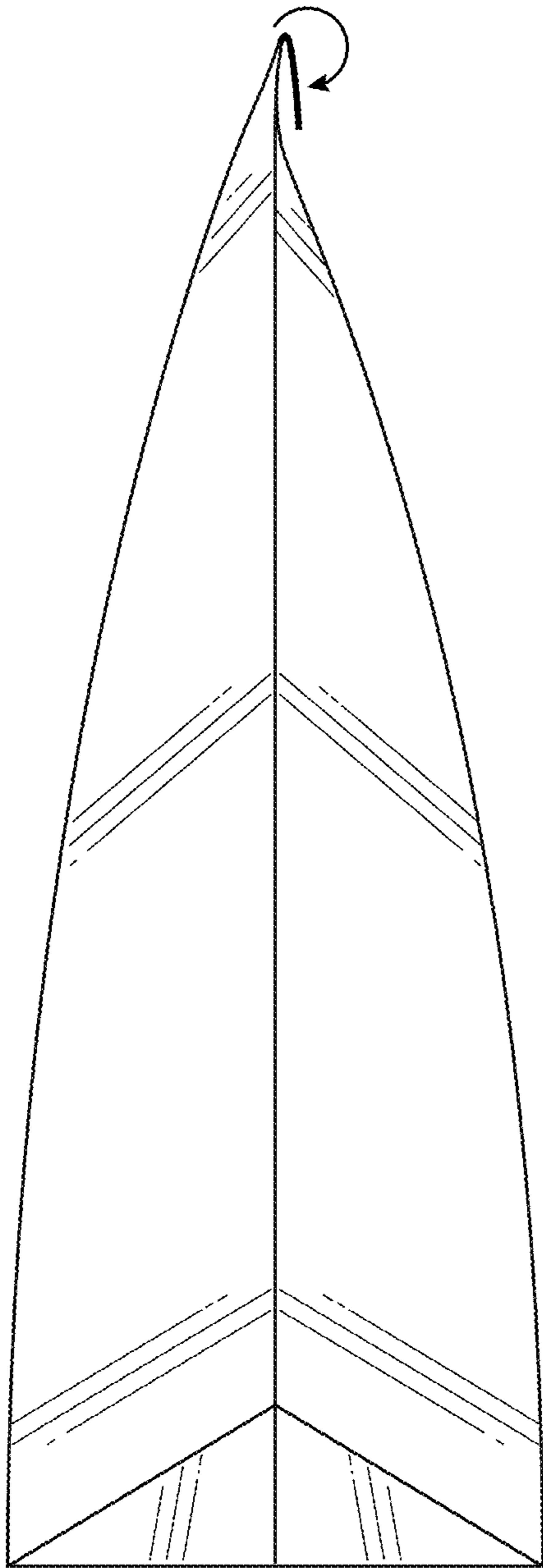

FIG. 9

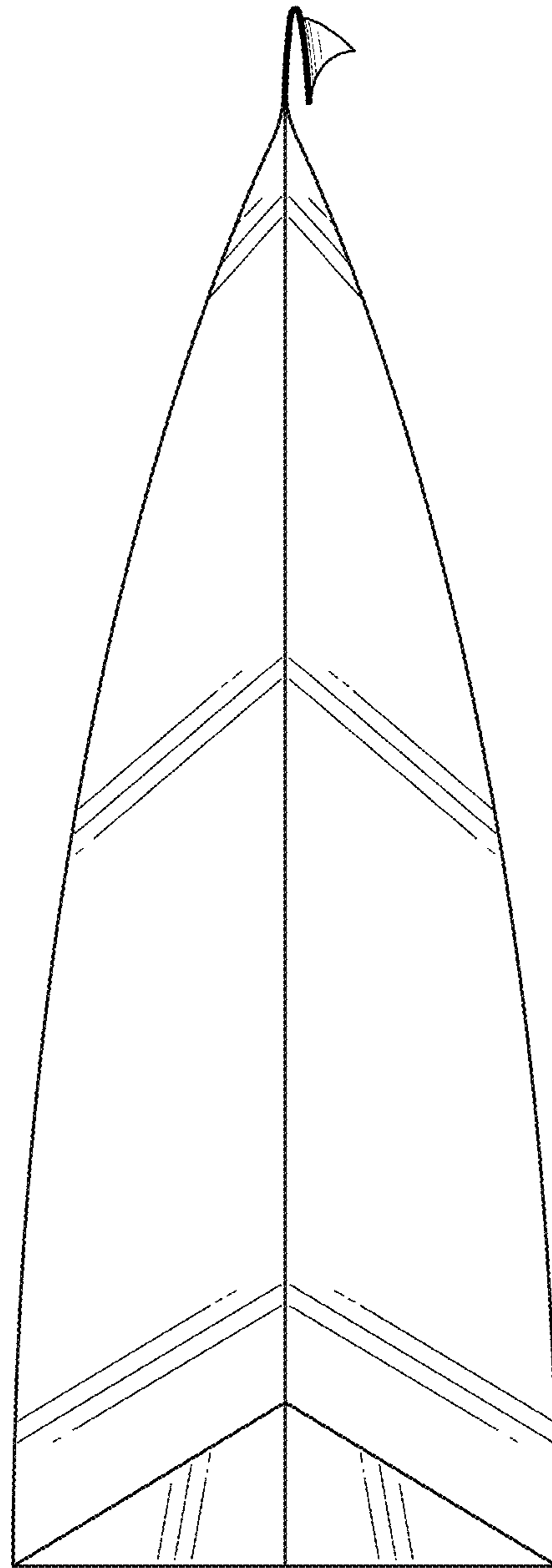

FIG. 10

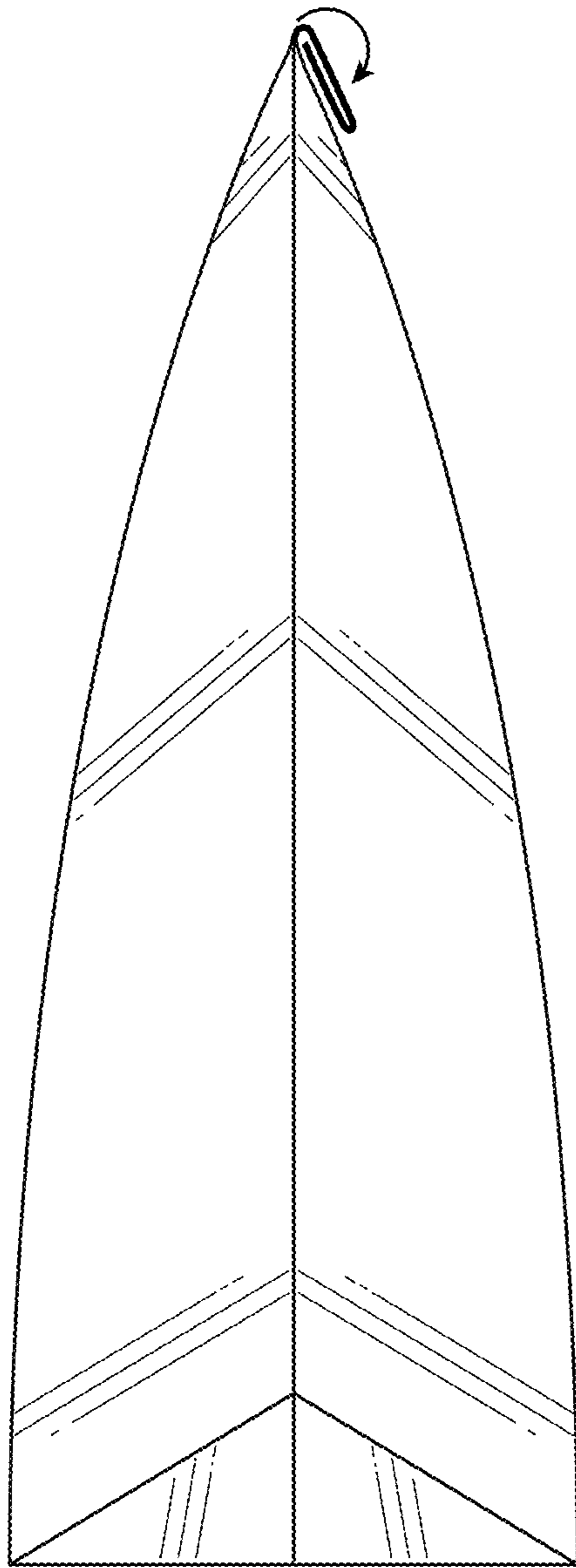

FIG. 11

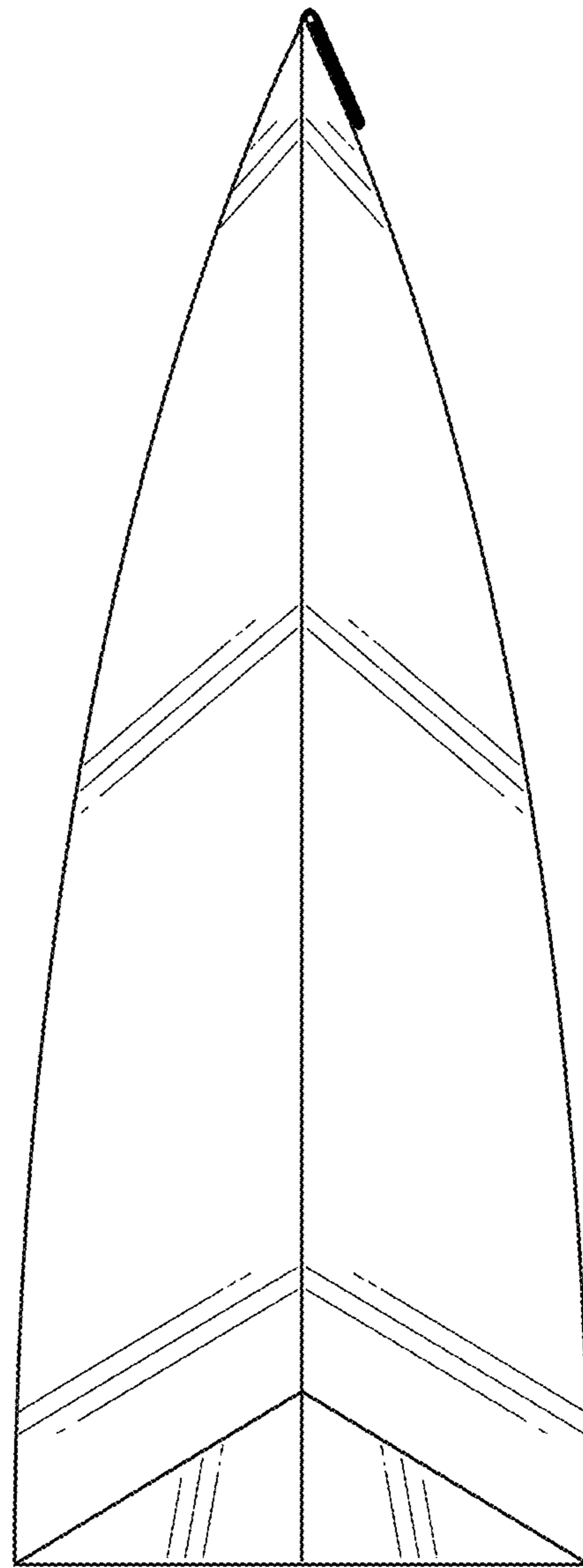

FIG. 12

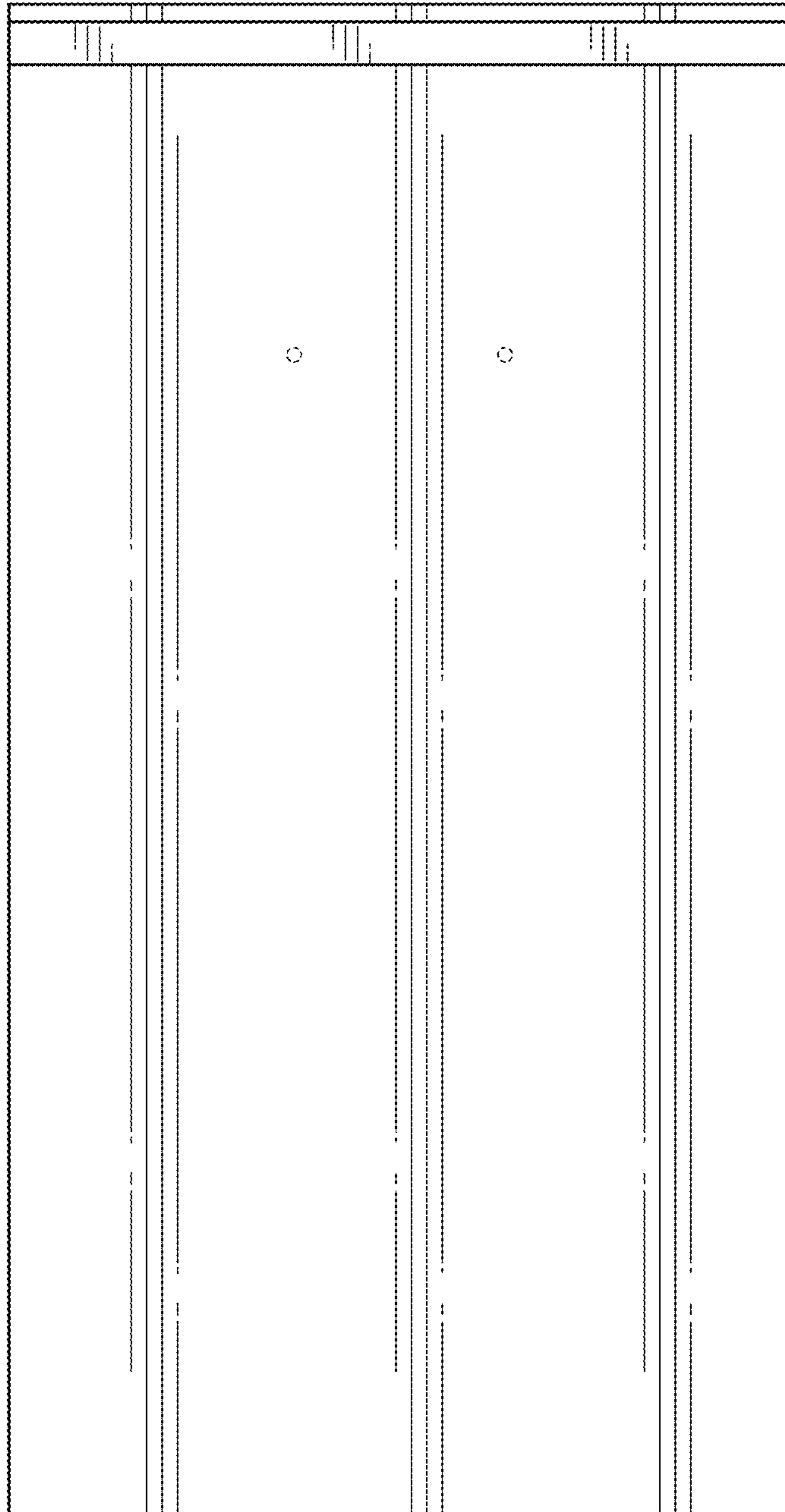

FIG. 13



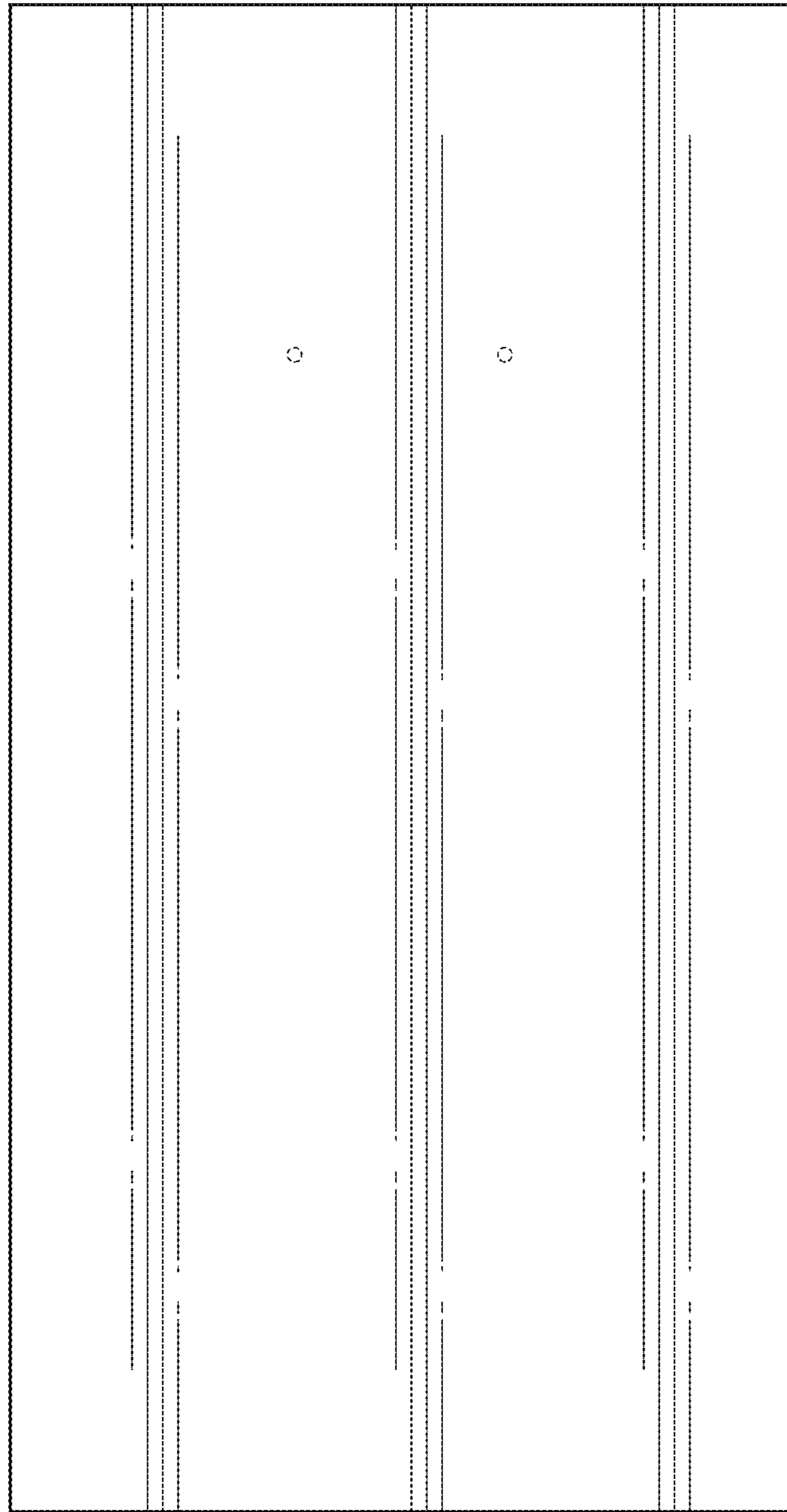

FIG. 14

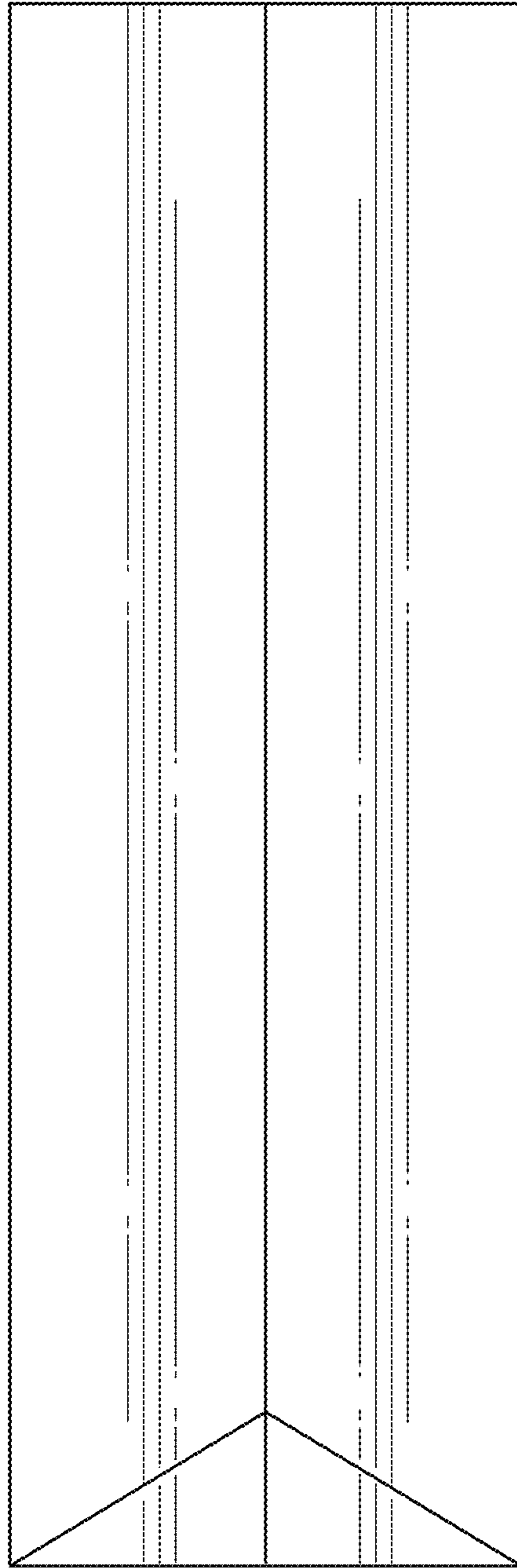

FIG. 15

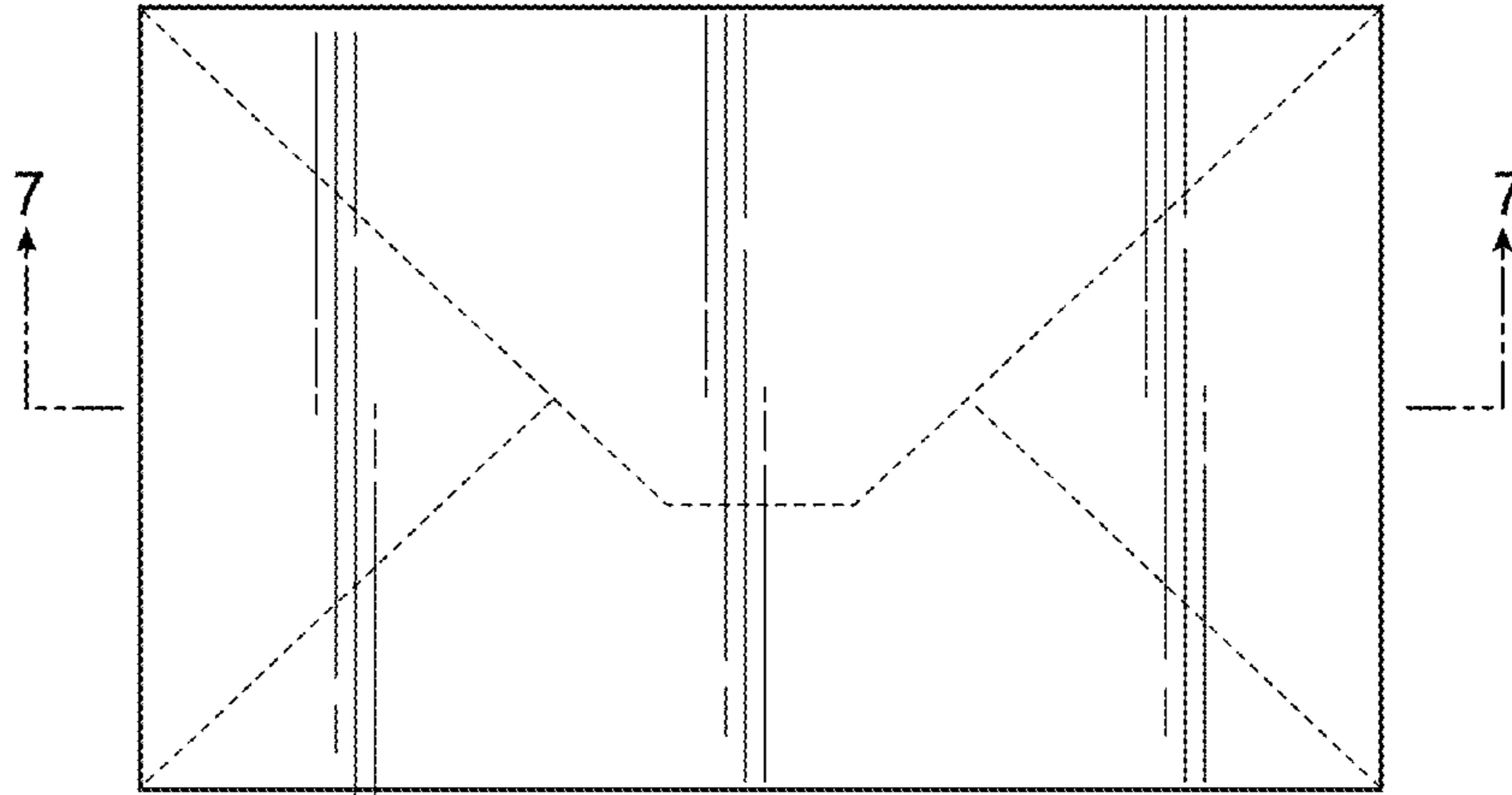

FIG. 16

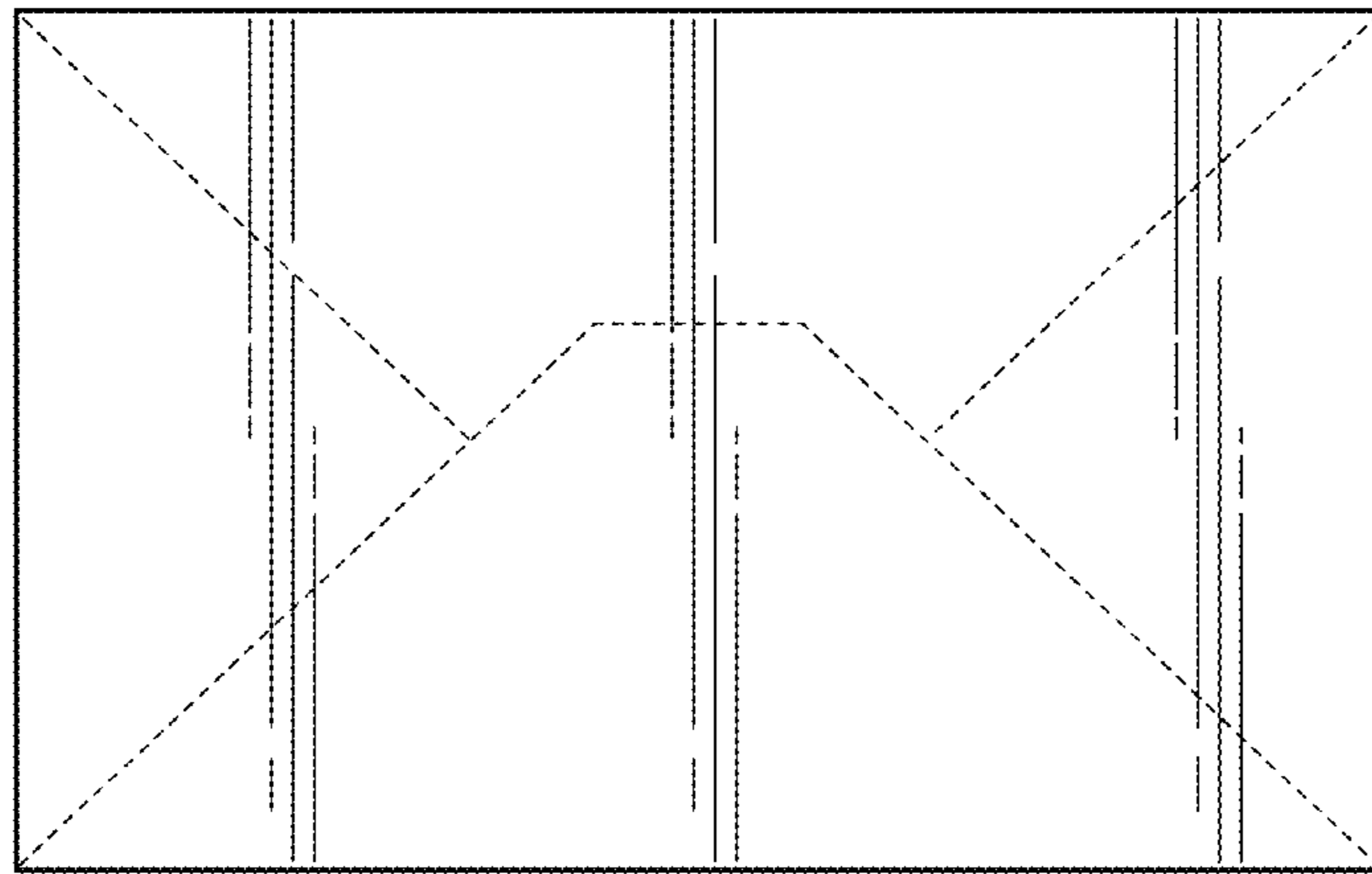

FIG. 17

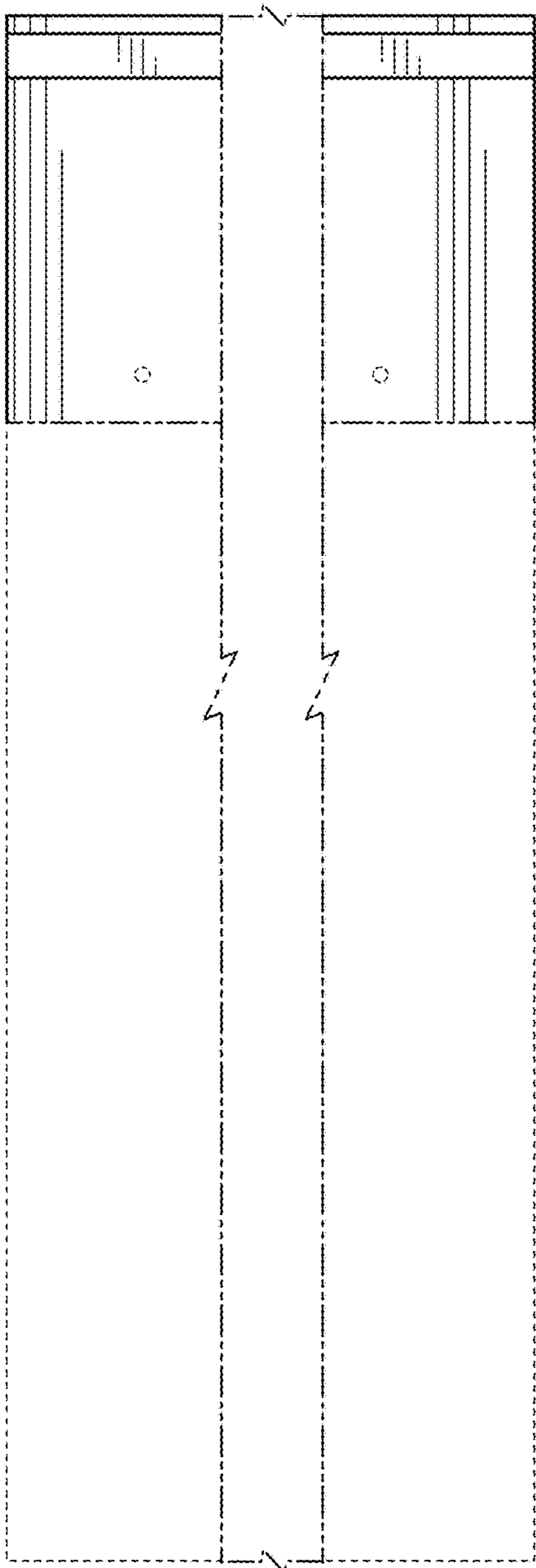

FIG. 18

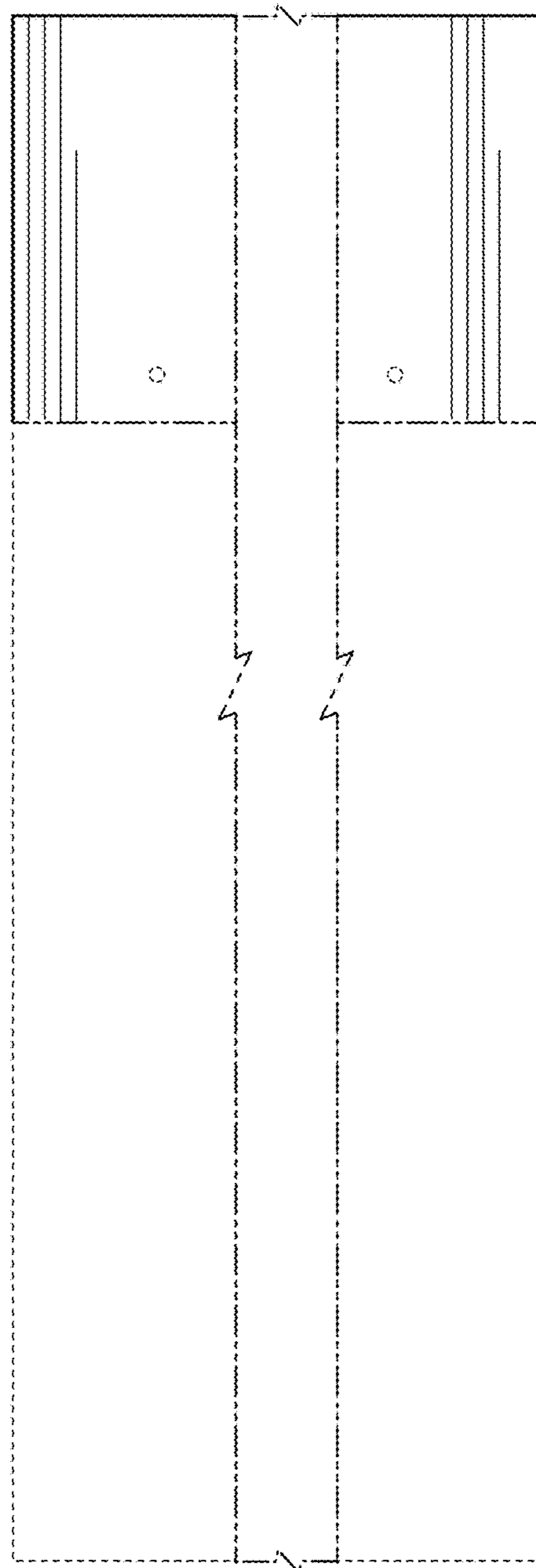

FIG. 19

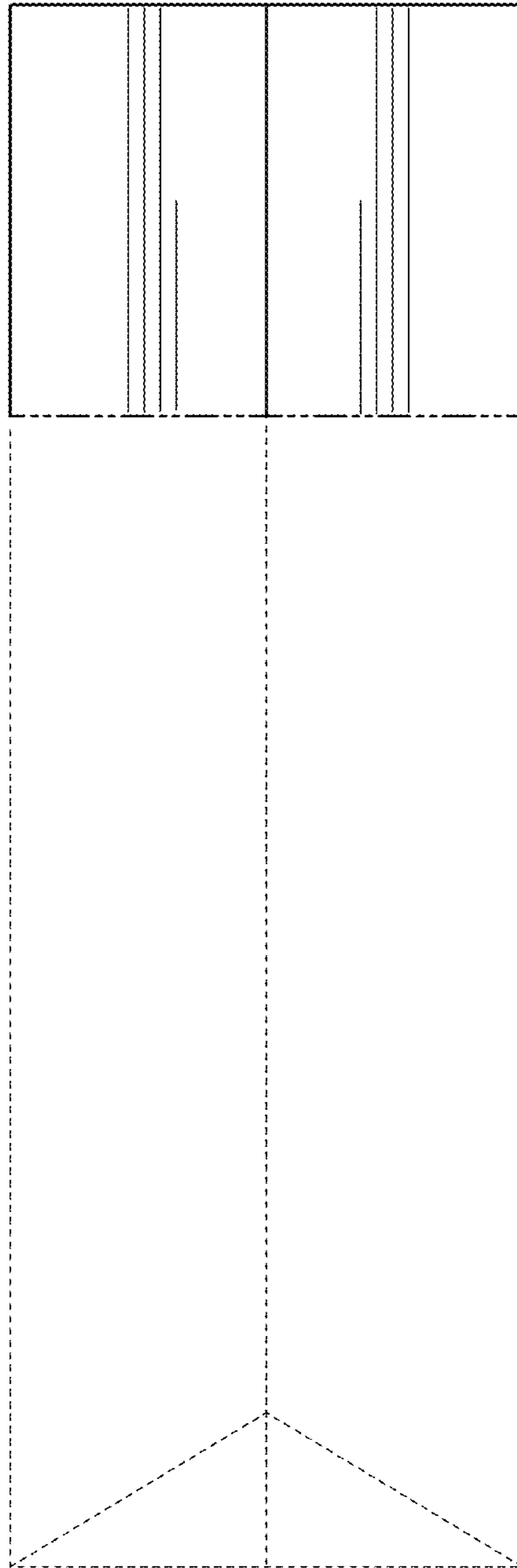

FIG. 20



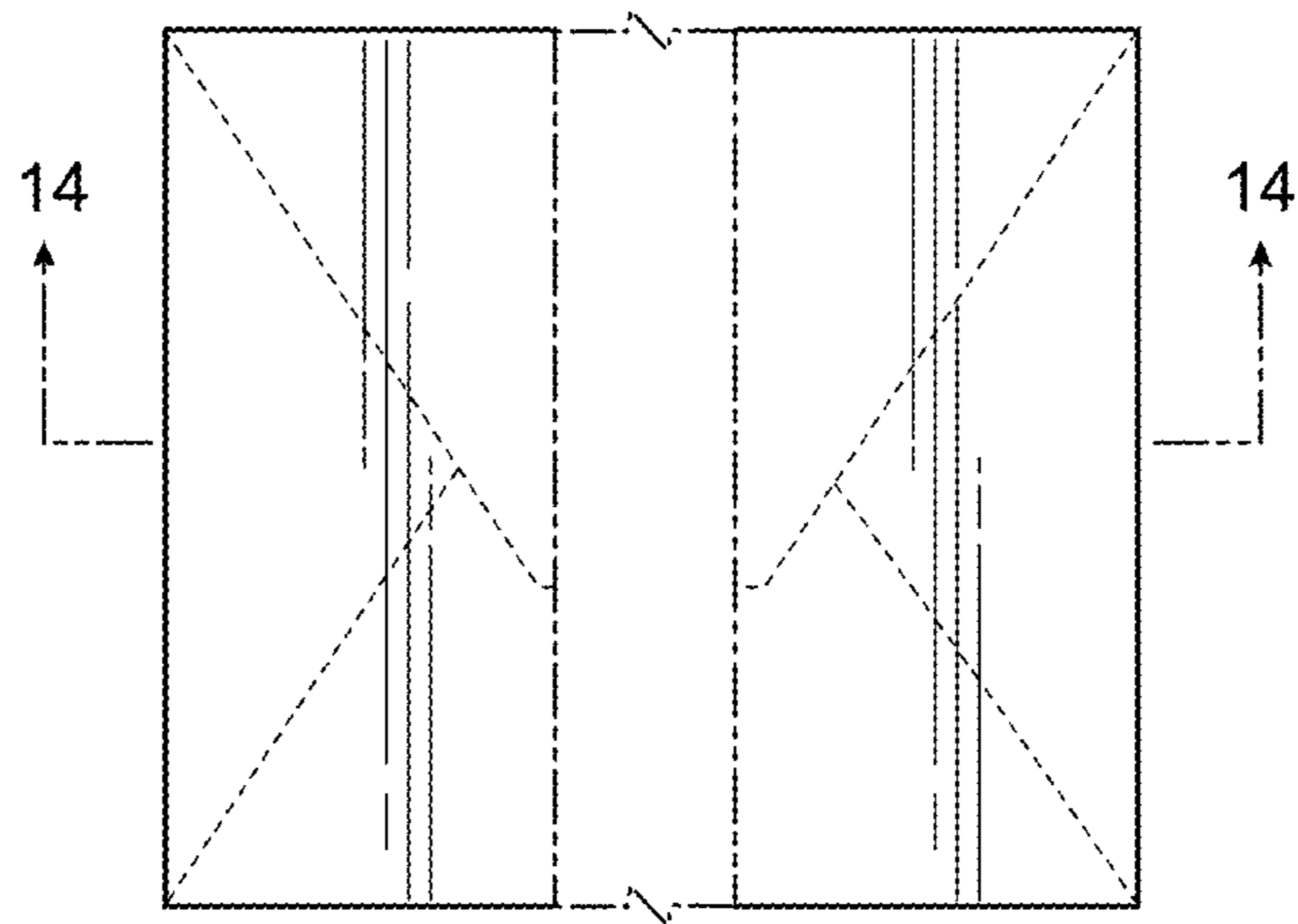

FIG. 21

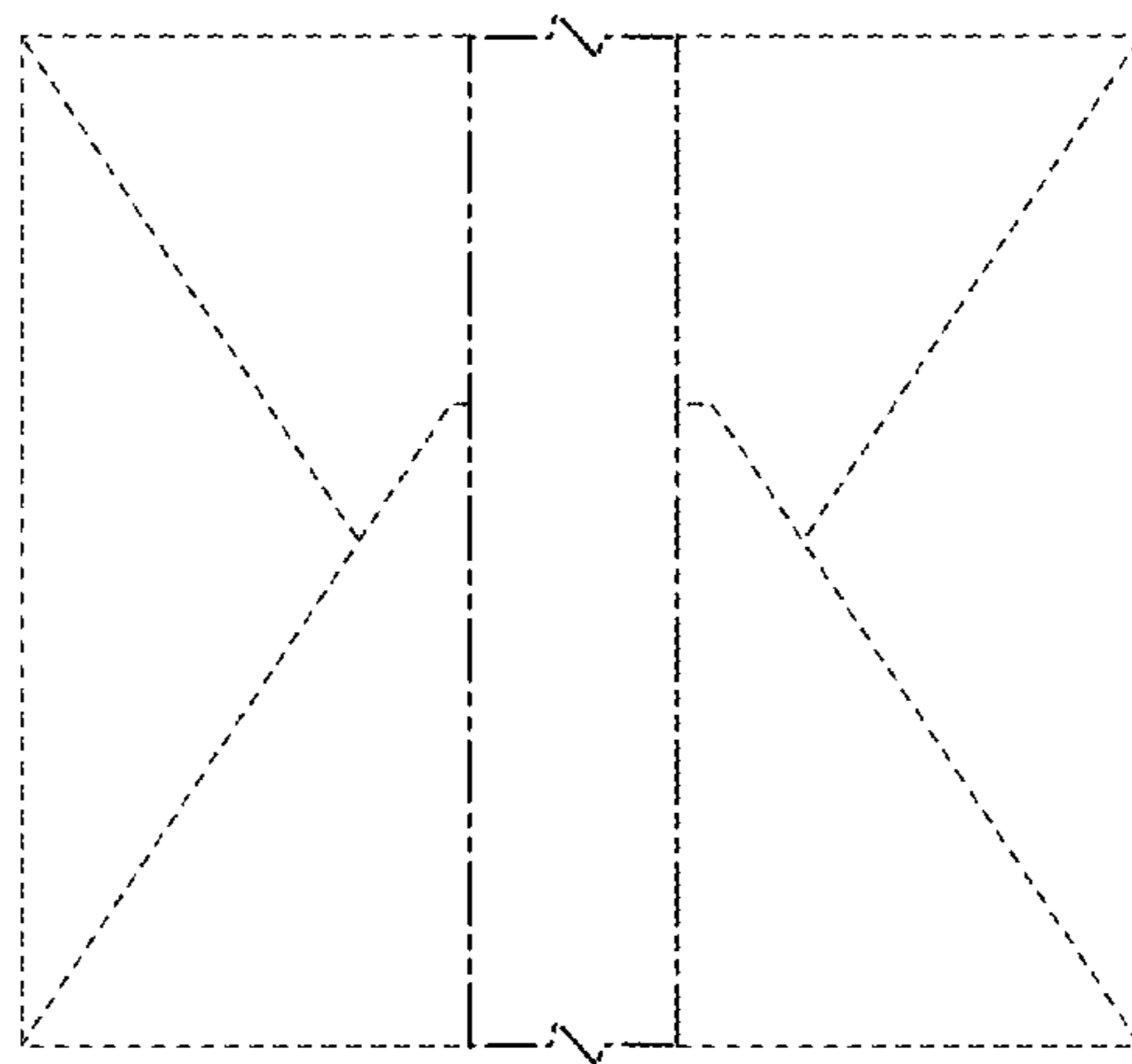

FIG. 22