



US00D830841S

(12) **United States Design Patent** (10) **Patent No.:** **US D830,841 S**  
**Toothman et al.** (45) **Date of Patent:** **\*\* Oct. 16, 2018**

(54) **FACETTED BOTTLE**

(71) Applicant: **Anheuser-Busch, LLC**, St. Louis, MO (US)

(72) Inventors: **Valerie Toothman**, New York, NY (US); **Gina Bazigian**, Fenton, MO (US); **Colleen Lucas**, Maplewood, NJ (US); **Phil Weyer**, Houston, TX (US); **Kaysonnia Hunt**, St. Louis, MO (US); **Nancy L. Poole**, St. Louis, MO (US); **Steve Martin**, Ridgeville, IN (US)

(73) Assignee: **Anheuser-Busch, LLC**, St. Louis, MO (US)

(\*\*) Term: **15 Years**

(21) Appl. No.: **29/575,910**

(22) Filed: **Aug. 30, 2016**

(51) **LOC (11) Cl.** ..... **09-01**

(52) **U.S. Cl.**  
USPC ..... **D9/555; D9/558; D9/652**

(58) **Field of Classification Search**  
USPC ..... D9/516, 544-546, 549, 550, 552, 554, D9/555, 575, 652, 667, 715, 719  
CPC . B65D 1/00; B65D 1/02; B65D 1/023; B65D 1/0223; B65D 1/0276  
See application file for complete search history.

(56) **References Cited**

**U.S. PATENT DOCUMENTS**

D169,239 S *	4/1953	Dillon	.....	D9/552
D448,677 S *	10/2001	Krich	.....	D9/553
D560,503 S *	1/2008	Siriporn	.....	D9/553
D603,712 S *	11/2009	James	.....	D9/538
D603,713 S *	11/2009	James	.....	D9/538
D603,714 S *	11/2009	James	.....	D9/538
D644,111 S *	8/2011	Williams	.....	D9/550

D653,118 S *	1/2012	Asano	.....	D9/520
D750,496 S *	3/2016	Cutler	.....	D9/538
D777,512 S *	1/2017	Lu	.....	D7/396.4
D791,604 S *	7/2017	Veyssiere	.....	D9/545
D793,241 S *	8/2017	Veyssiere	.....	D9/545
D797,566 S *	9/2017	Home	.....	D9/545

\* cited by examiner

*Primary Examiner* — Ian Simmons

*Assistant Examiner* — Keith Frank

(74) *Attorney, Agent, or Firm* — Husch Blackwell LLP

(57) **CLAIM**

We claim the ornamental design for a faceted bottle, as shown and described.

**DESCRIPTION**

FIG. 1 is a front perspective view of a faceted bottle showing the new design;  
FIG. 2 is a left side elevation view thereof;  
FIG. 3 is a right side elevation view thereof;  
FIG. 4 is a front elevation view thereof;  
FIG. 5 is a rear elevation view thereof;  
FIG. 6 is a top plan view thereof; and  
FIG. 7 is a bottom plan view thereof.  
FIG. 8 is a cross sectional plan view taken along line 8-8 of FIG. 5;  
FIG. 9 is a cross sectional plan view taken along line 9-9 of FIG. 5;  
FIG. 10 is a cross sectional plan view taken along line 10-10 of FIG. 5;  
FIG. 11 is a cross sectional plan view taken along line 11-11 of FIG. 5; and,  
FIG. 12 is a cross sectional plan view taken along line 12-12 of FIG. 5.

The broken lines in the drawings showing the faceted bottle illustrate the portions of the faceted bottle that form no part of the claimed design.

**1 Claim, 5 Drawing Sheets**

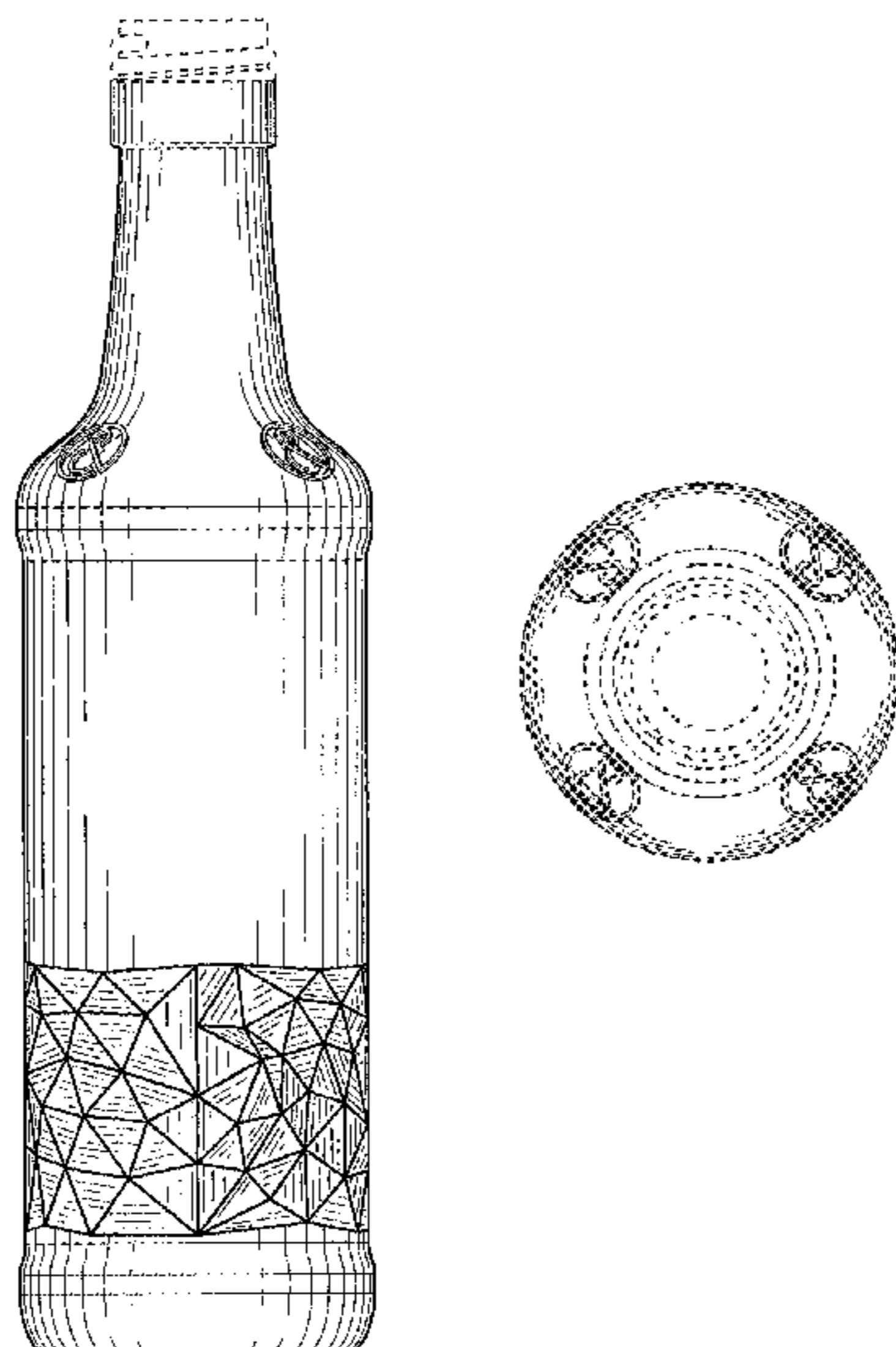

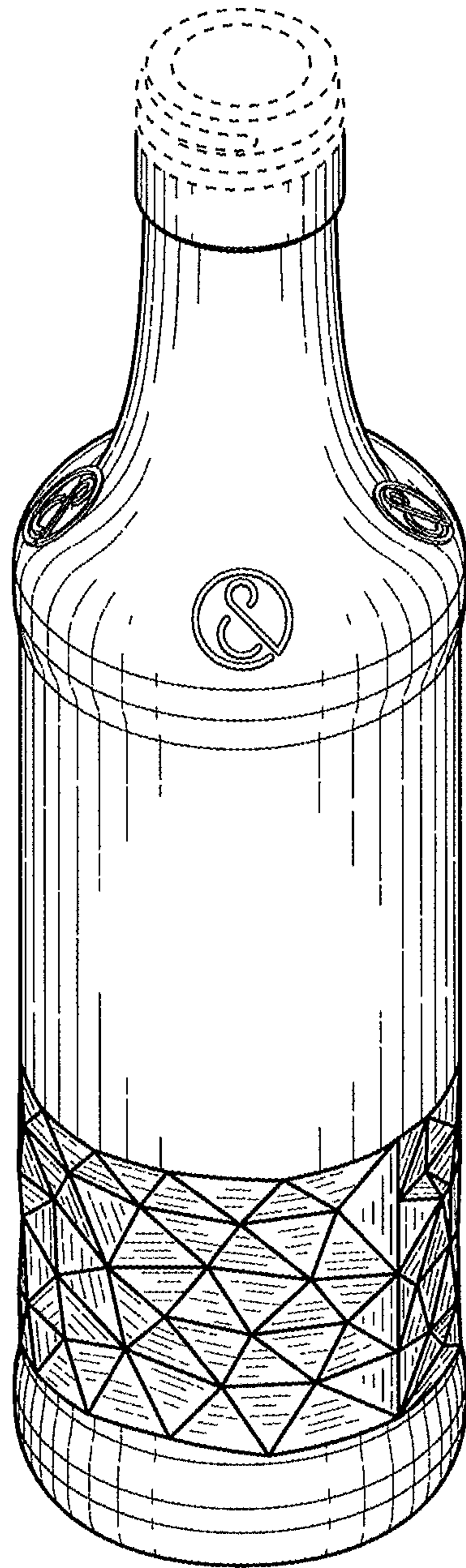

FIG. 1

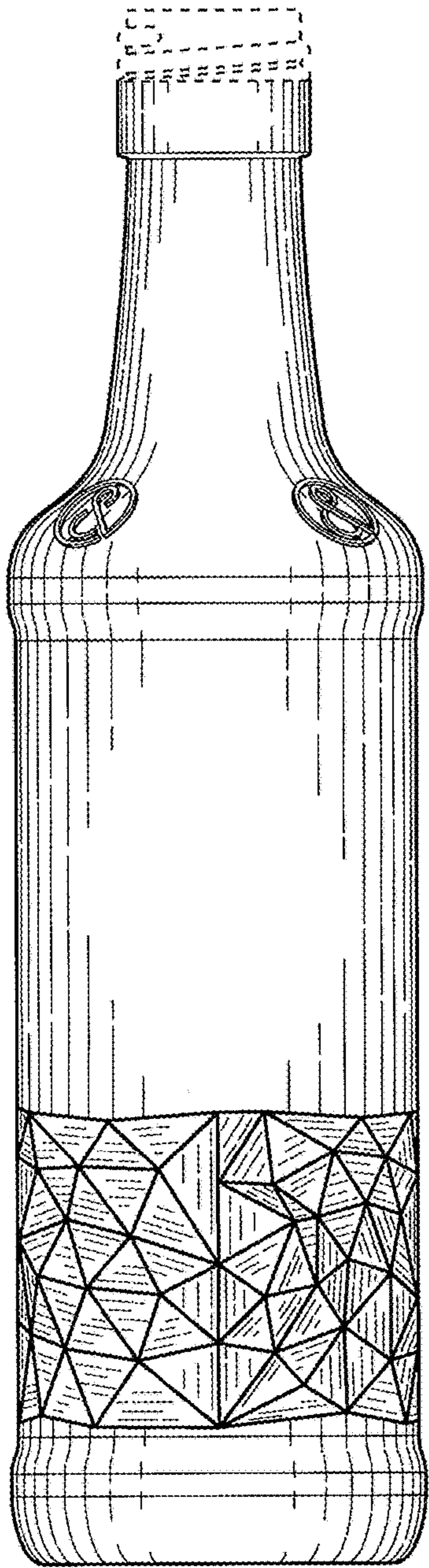

FIG. 2

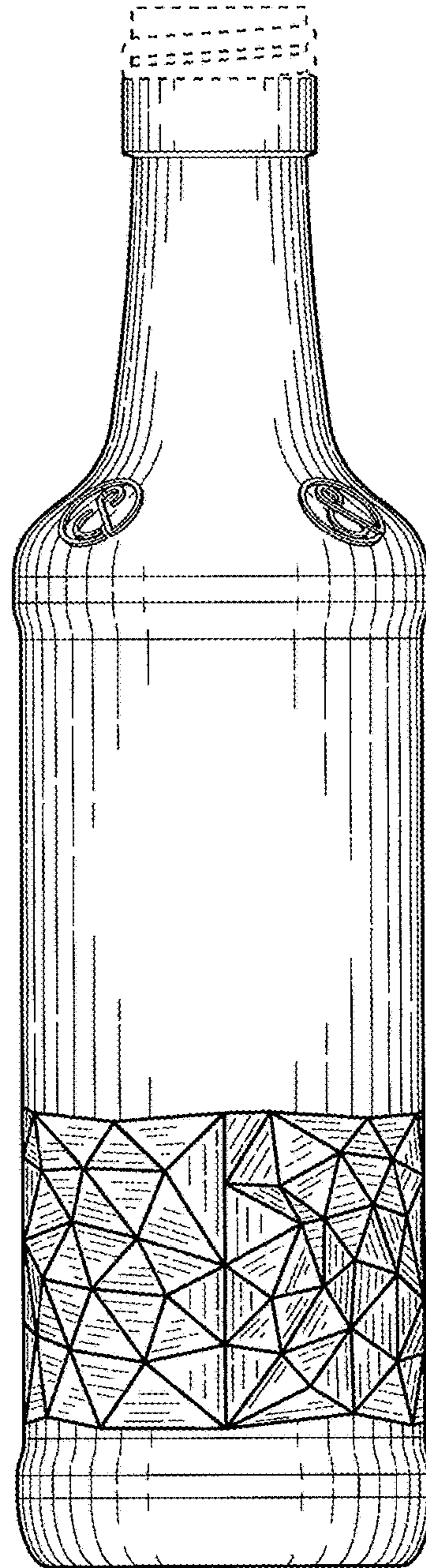

FIG. 3

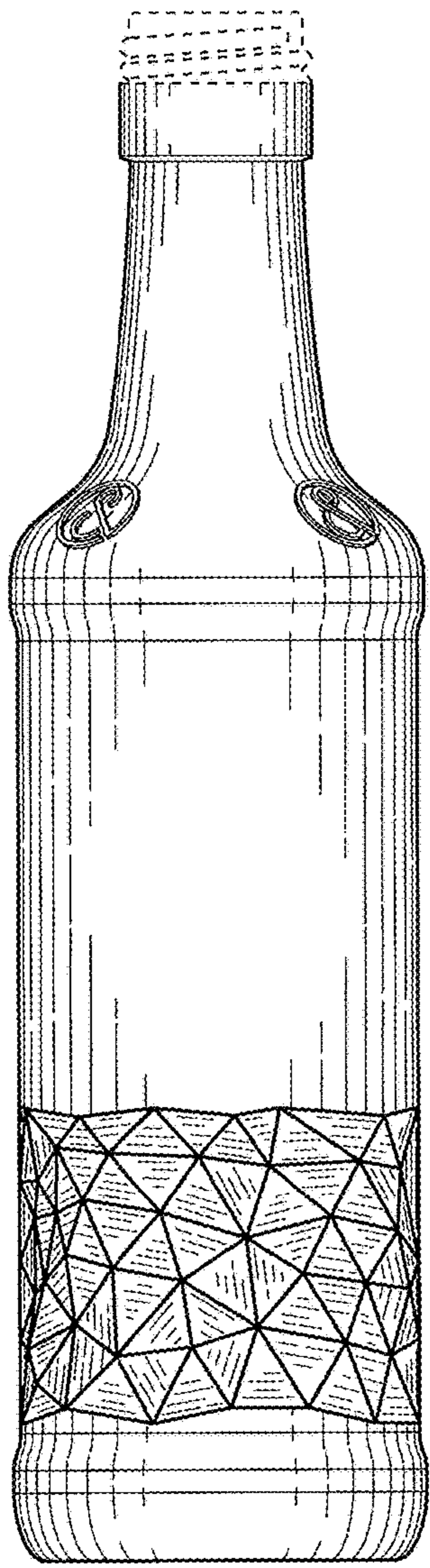

FIG. 4

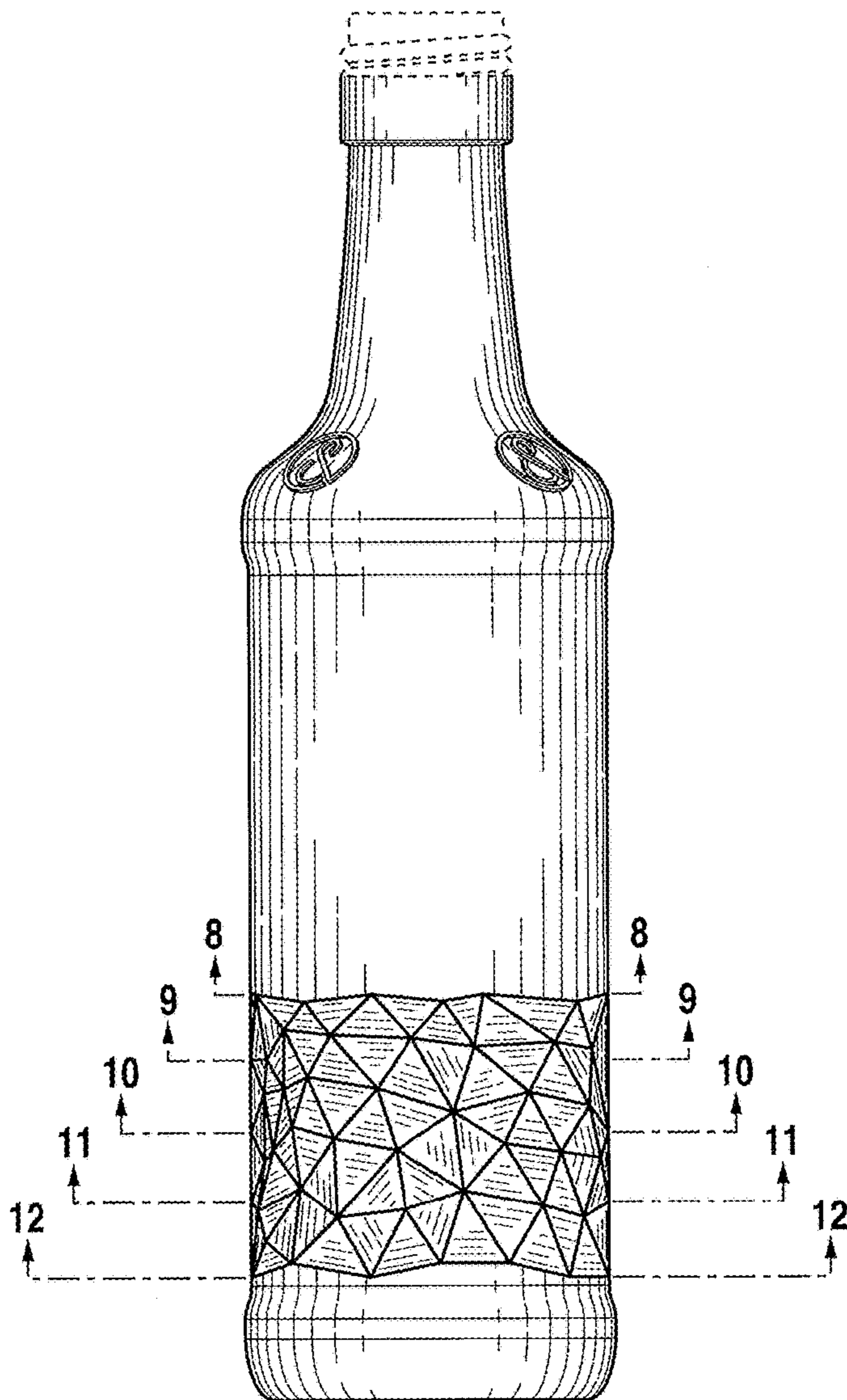

FIG. 5

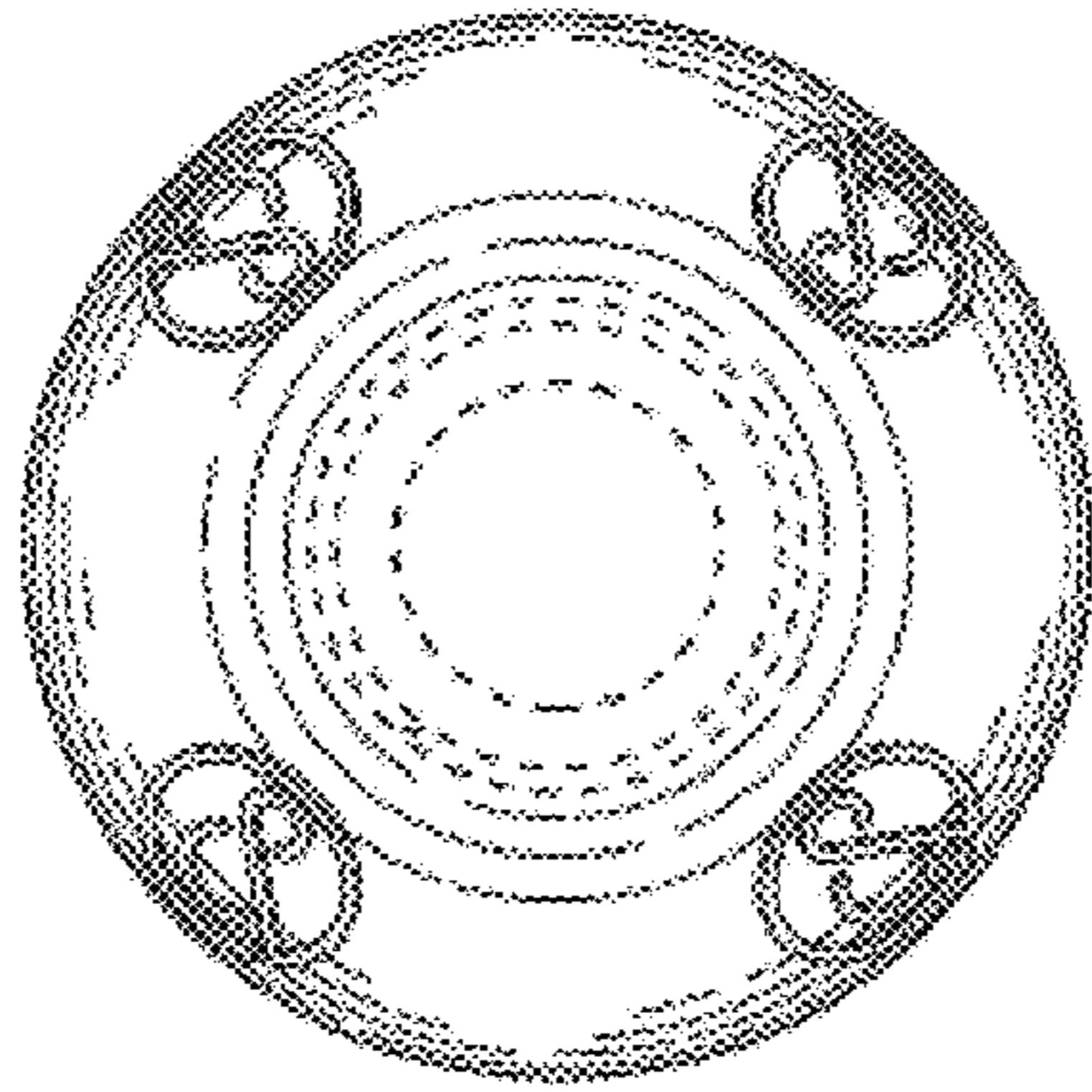

FIG. 6

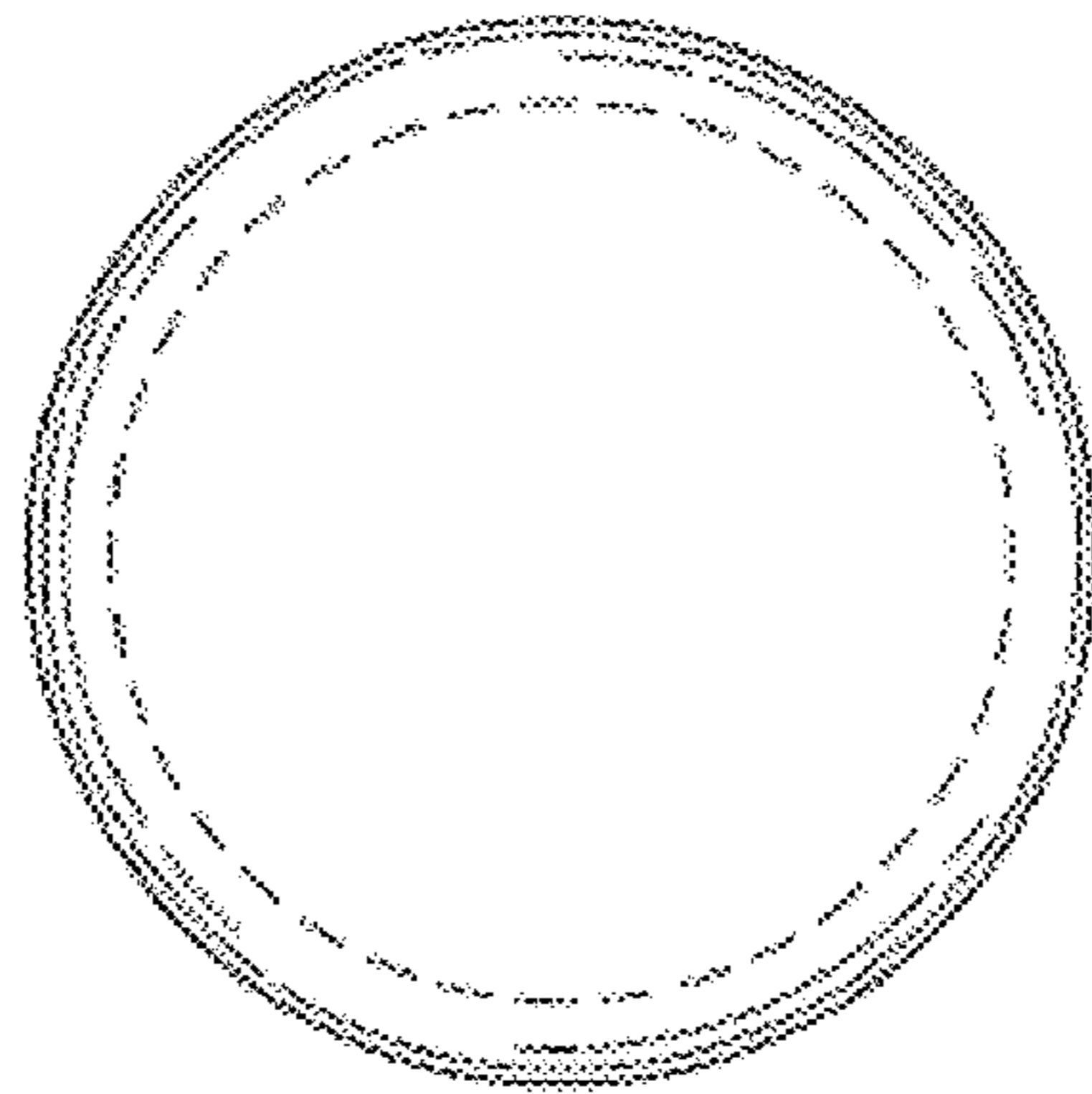

FIG. 7

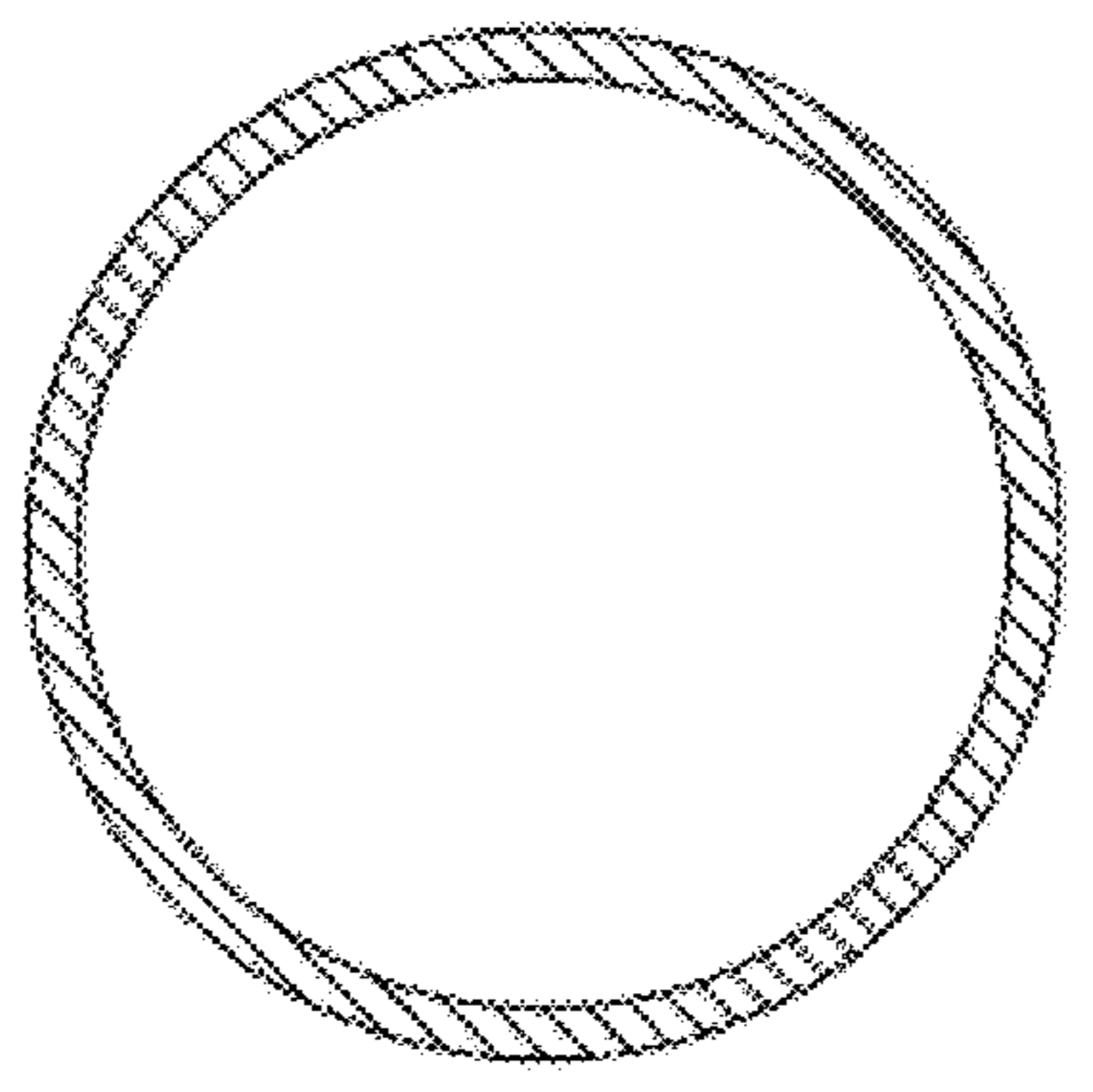

FIG. 8

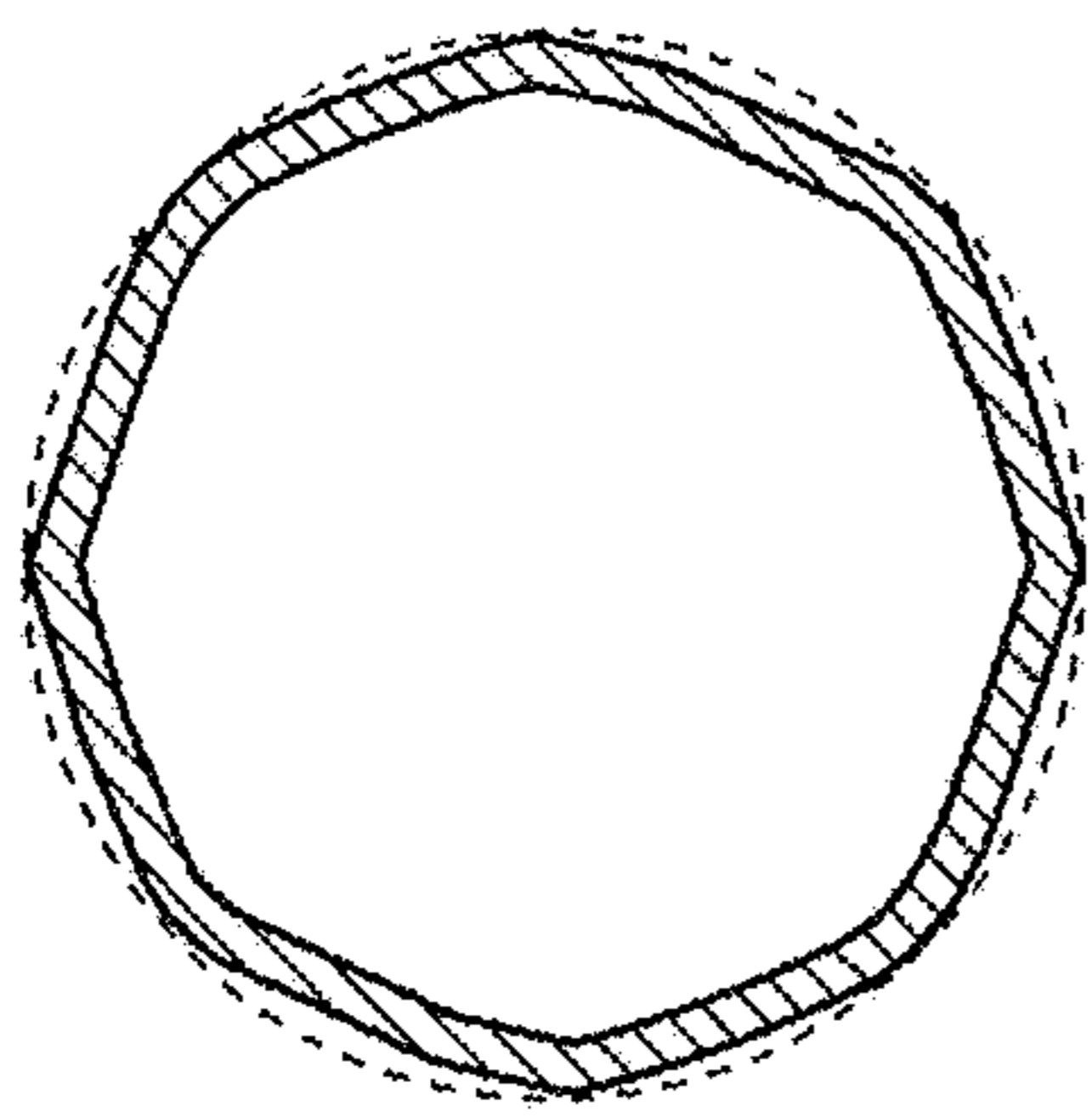

FIG. 9

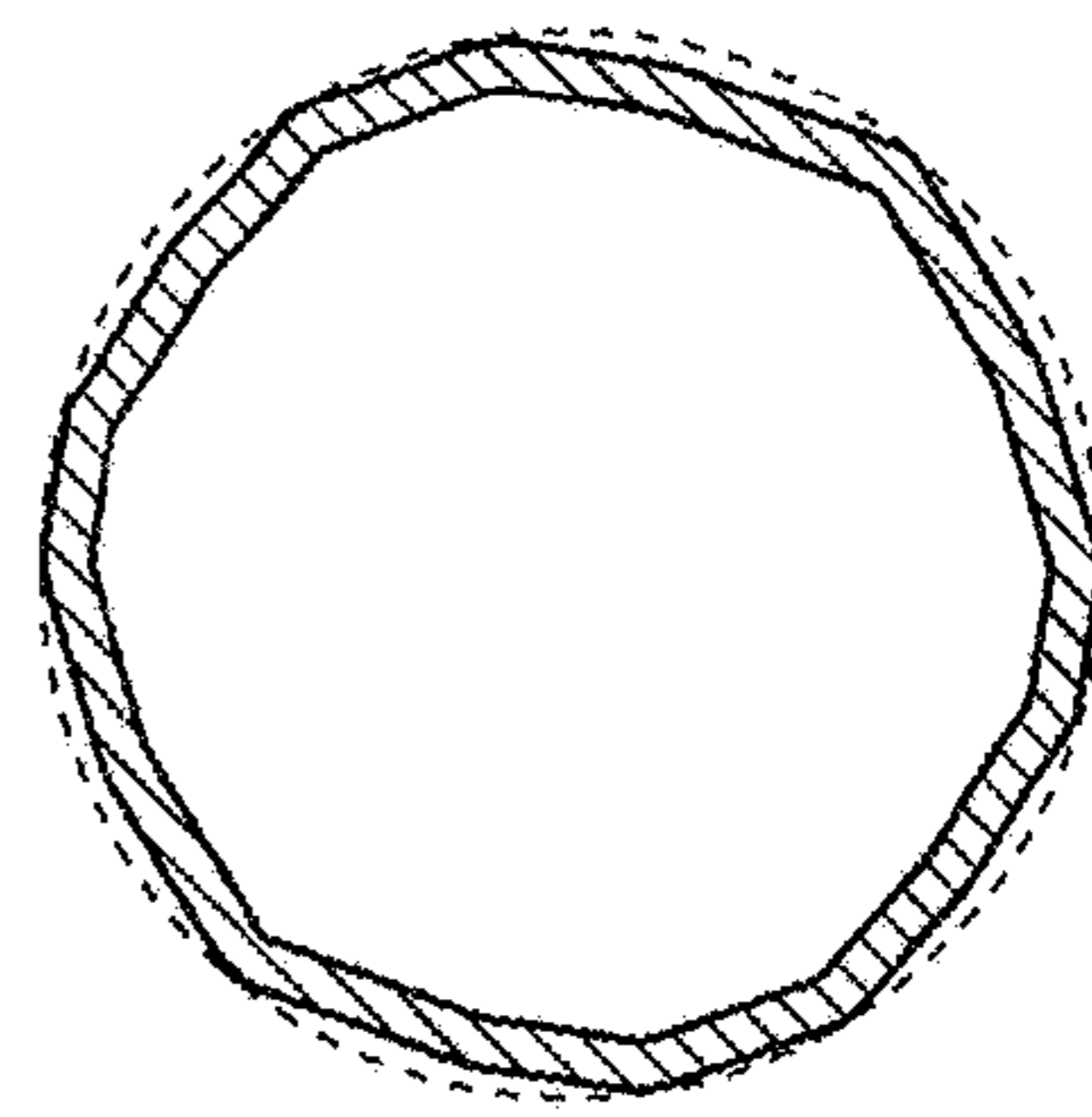

FIG. 11

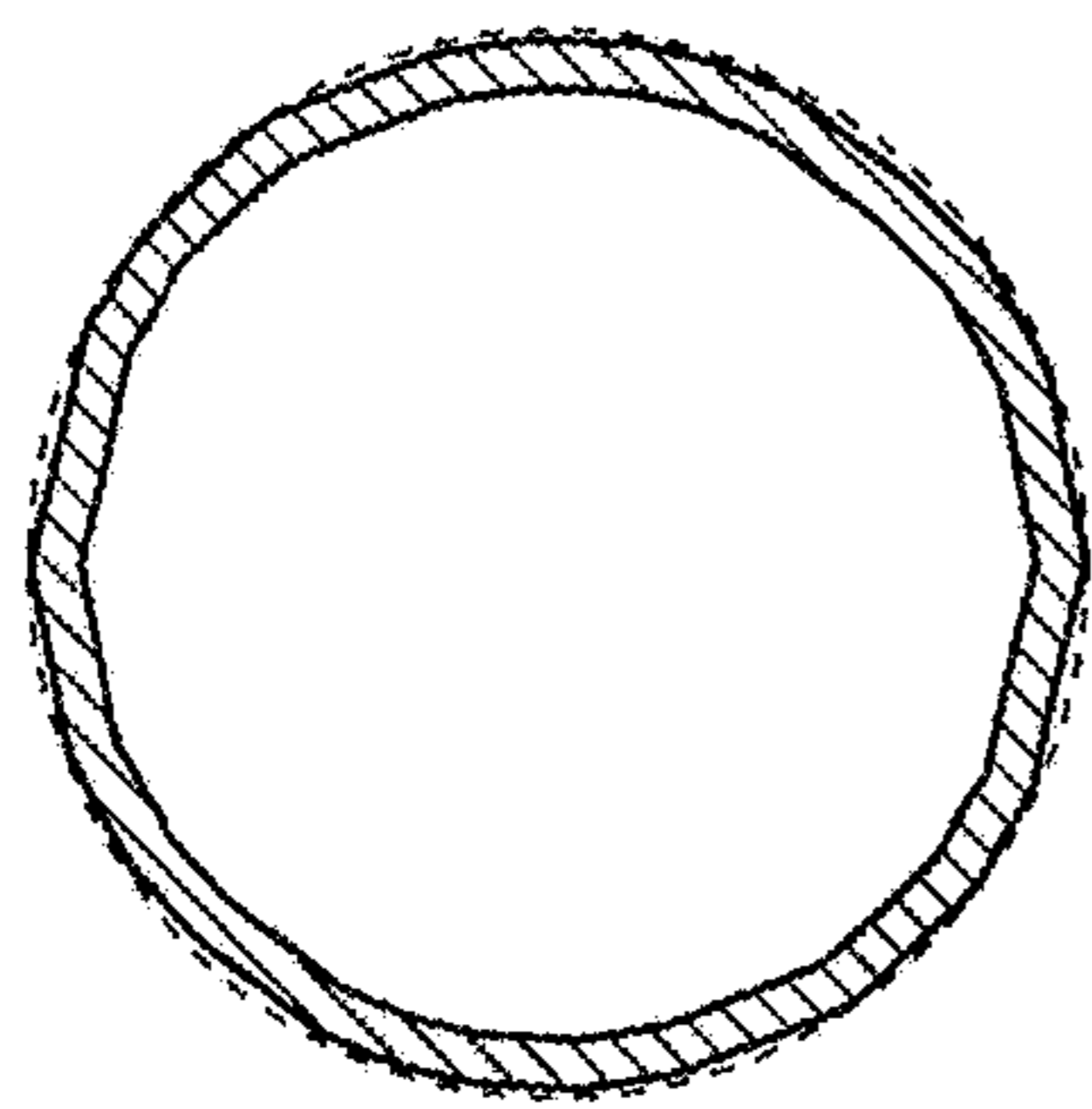

FIG. 10

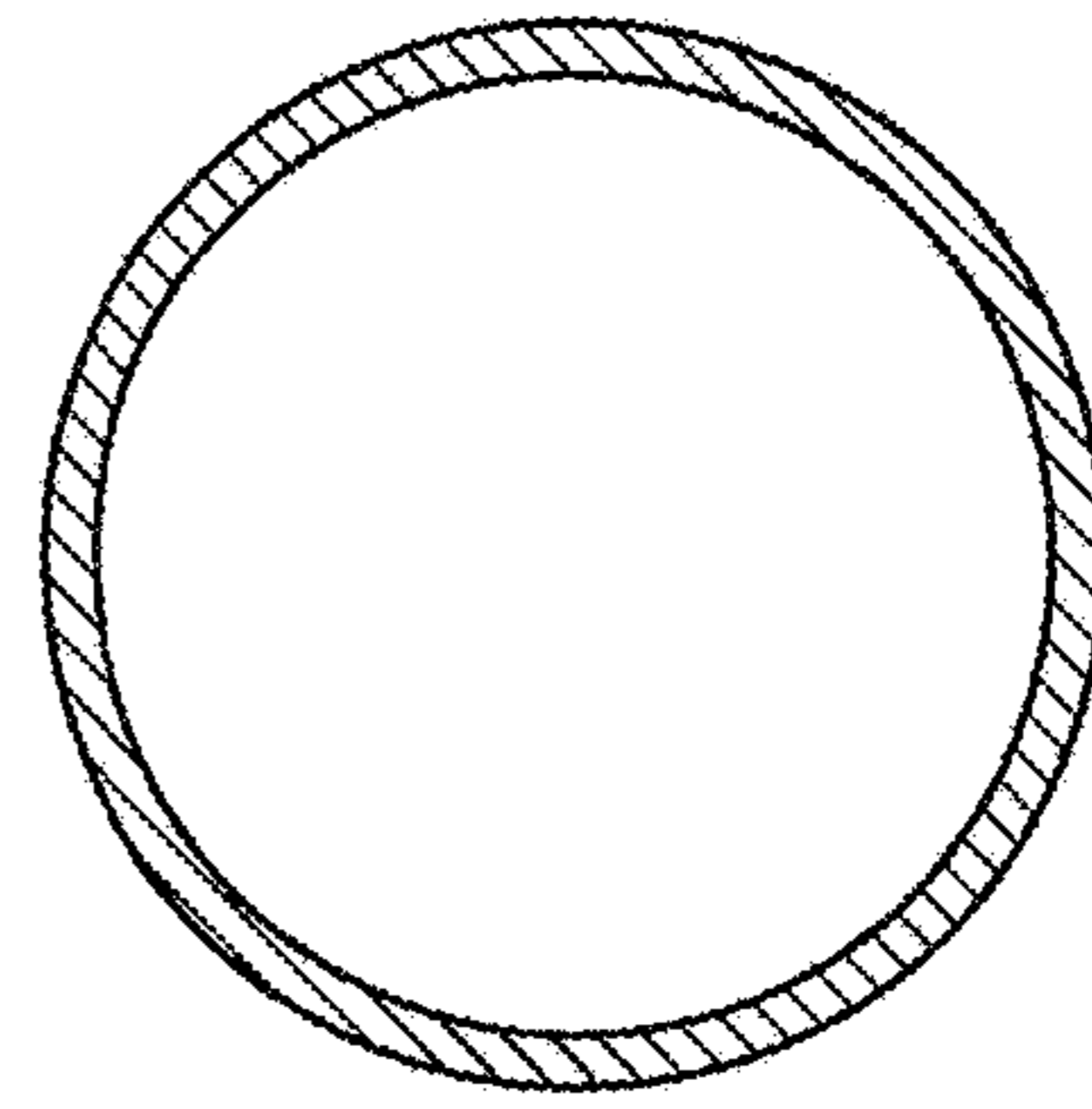

FIG. 12