



US00D830758S

(12) **United States Design Patent** (10) **Patent No.:** **US D830,758 S**
Bodum (45) **Date of Patent:** **** Oct. 16, 2018**

(54) **COFFEE MAKER** 2,414,901 A * 1/1947 Schlumbohm A47J 45/08
215/396
(71) Applicant: **PI-Design AG**, Triengen (CH) 2,705,086 A * 3/1955 Schlumbohm A47J 45/10
215/396
(72) Inventor: **Jorgen Bodum**, Meggen (CH) 3,145,708 A * 8/1964 Fischer A47G 19/12
126/390.1
(73) Assignee: **PI-Design AG**, Triengen (CH) D205,236 S * 7/1966 Ilg 141/331
3,334,574 A * 8/1967 Douglas A47J 31/02
210/455
(**) Term: **15 Years** D224,034 S * 6/1972 Douglas D7/318
3,739,932 A * 6/1973 Westover A47J 45/10
16/435

(21) Appl. No.: **29/597,340**

(22) Filed: **Mar. 16, 2017**

(Continued)

Related U.S. Application Data

(62) Division of application No. 29/579,442, filed on Sep. 30, 2016, now Pat. No. Des. 793,147.

Foreign Application Priority Data

Apr. 4, 2016 (WO) DM/090141

(51) **LOC (11) Cl.** **07-01**

(52) **U.S. Cl.**
USPC **D7/316**

(58) **Field of Classification Search**
USPC D7/316-322, 598, 600, 536, 507;
222/188, 465.1, 713; D23/209; 99/285,
99/304, 292; 215/396
CPC A47J 41/0027; A47J 31/50; A47J 45/0077;
A47J 31/053; A47J 31/20; A47J 31/02;
A47J 45/10; A47J 31/14; A47J 411/02;
A47J 31/38; A47J 31/306; A47J 45/08;
A47G 19/22; A47G 19/12

See application file for complete search history.

(56) **References Cited**

U.S. PATENT DOCUMENTS

D137,943 S * 5/1944 Schlumbohm 16/DIG. 24
D138,561 S * 8/1944 Schlumbohm D7/312
2,411,340 A * 11/1946 Schlumbohm A47G 19/12
222/465.1

FOREIGN PATENT DOCUMENTS

WO DM/087954 8/2015
WO DM/087902 10/2015

OTHER PUBLICATIONS

PI-Design AG, U.S. Appl. No. 29/561,537, filed Apr. 18, 2016.

(Continued)

Primary Examiner — Marianne Pandozzi
(74) *Attorney, Agent, or Firm* — McDonnell Boehnen
Hulbert & Berghoff LLP

(57) **CLAIM**

The ornamental design for a coffee maker, as shown and described.

DESCRIPTION

FIG. 1 is a perspective view of a coffee maker showing my new design;
FIG. 2 is a front view thereof;
FIG. 3 is a rear view thereof;
FIG. 4 is a left side view thereof;
FIG. 5 is a right side view thereof;
FIG. 6 is a top view thereof; and,
FIG. 7 is a bottom view thereof.

1 Claim, 7 Drawing Sheets

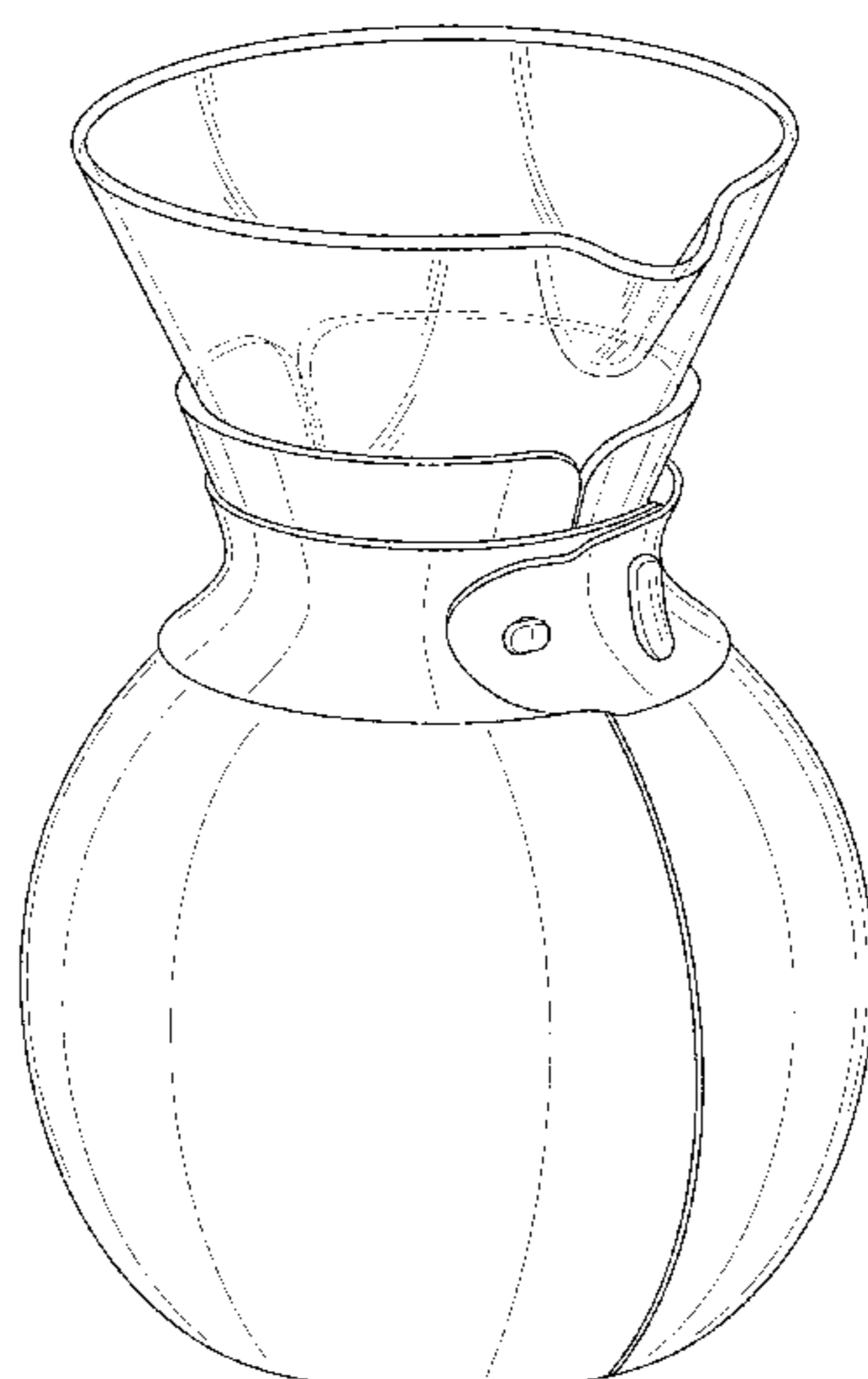

(56)

References Cited

U.S. PATENT DOCUMENTS

3,985,069 A * 10/1976 Cavalluzzi B65D 85/8043
426/77
D250,804 S * 1/1979 Nilsson D7/400
4,629,866 A * 12/1986 Proctor A47J 27/002
126/378.1
D302,093 S * 7/1989 Palsby D7/317
D452,408 S * 12/2001 Liu D7/316
D453,657 S * 2/2002 Eklin D7/315
D515,349 S * 2/2006 Gillisie D7/317
D536,205 S * 2/2007 Jensen D7/300
D560,091 S * 1/2008 Bodum D7/312
D567,005 S * 4/2008 Bodum D7/312
D567,008 S * 4/2008 Bodum D7/312
D567,009 S * 4/2008 Bodum D7/312
D568,086 S * 5/2008 Brown D7/317
D580,696 S * 11/2008 Bodum D7/316
D591,549 S * 5/2009 Ranzoni D7/317
D598,234 S * 8/2009 Bodum D7/317
D611,754 S * 3/2010 Bodum D7/310
D655,563 S * 3/2012 Kern D7/317
D661,939 S * 6/2012 Kern D7/316
D742,160 S * 11/2015 Bodum D7/316
D745,739 S * 12/2015 Abadi D27/162
D746,092 S * 12/2015 Melzer D7/325
D752,376 S * 3/2016 Melzer D7/317
D785,396 S * 5/2017 Bodum D7/319
D786,003 S * 5/2017 Bodum D7/319
D786,605 S * 5/2017 Bodum D7/316
D787,253 S * 5/2017 Bodum D7/310

OTHER PUBLICATIONS

Select portions of Bodum Collection Catalogue, Jan. 2015, 7 pages.
PI-Design AG, U.S. Appl. No. 29/554,812, filed Feb. 16, 2016.

* cited by examiner

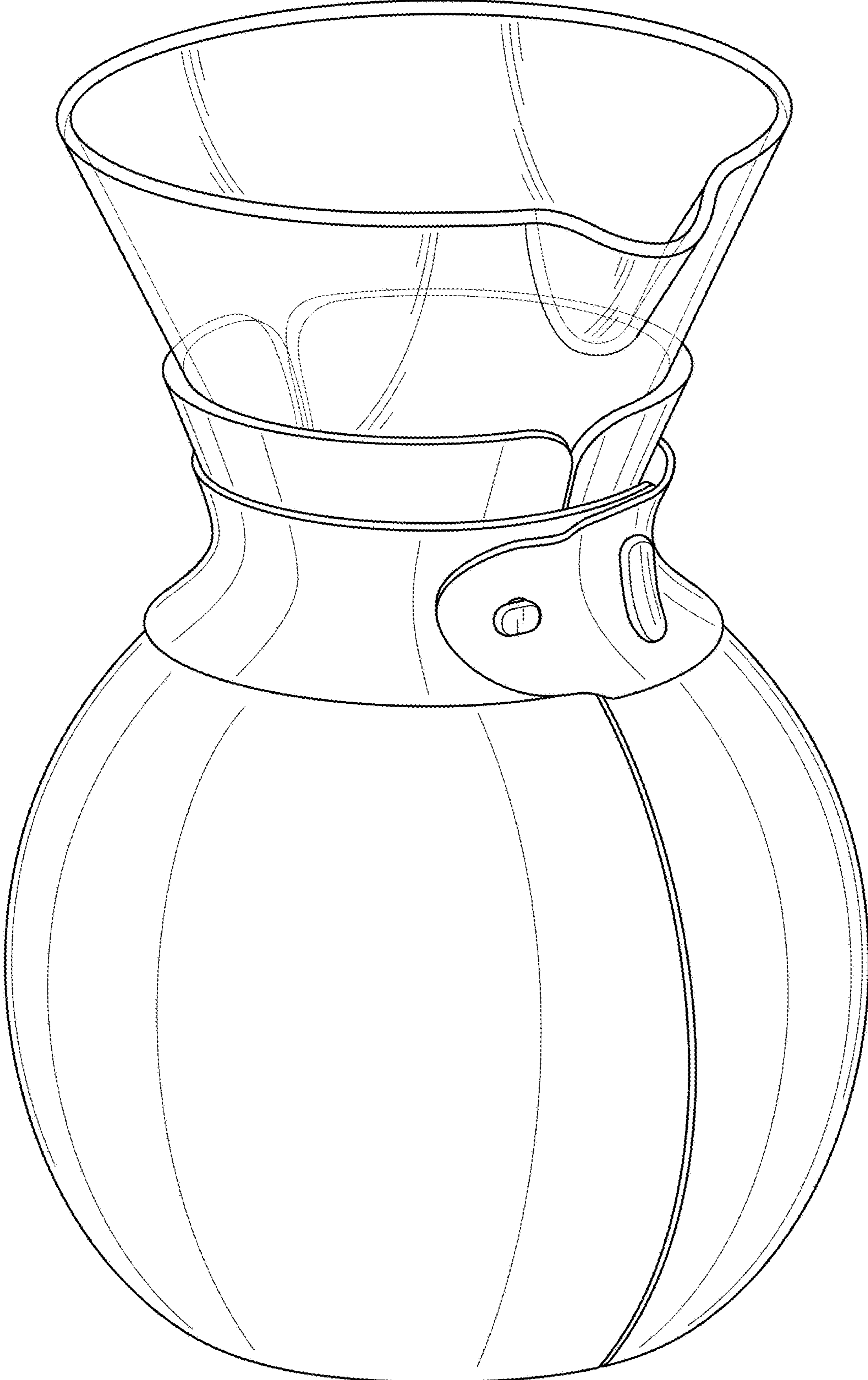

FIG. 1

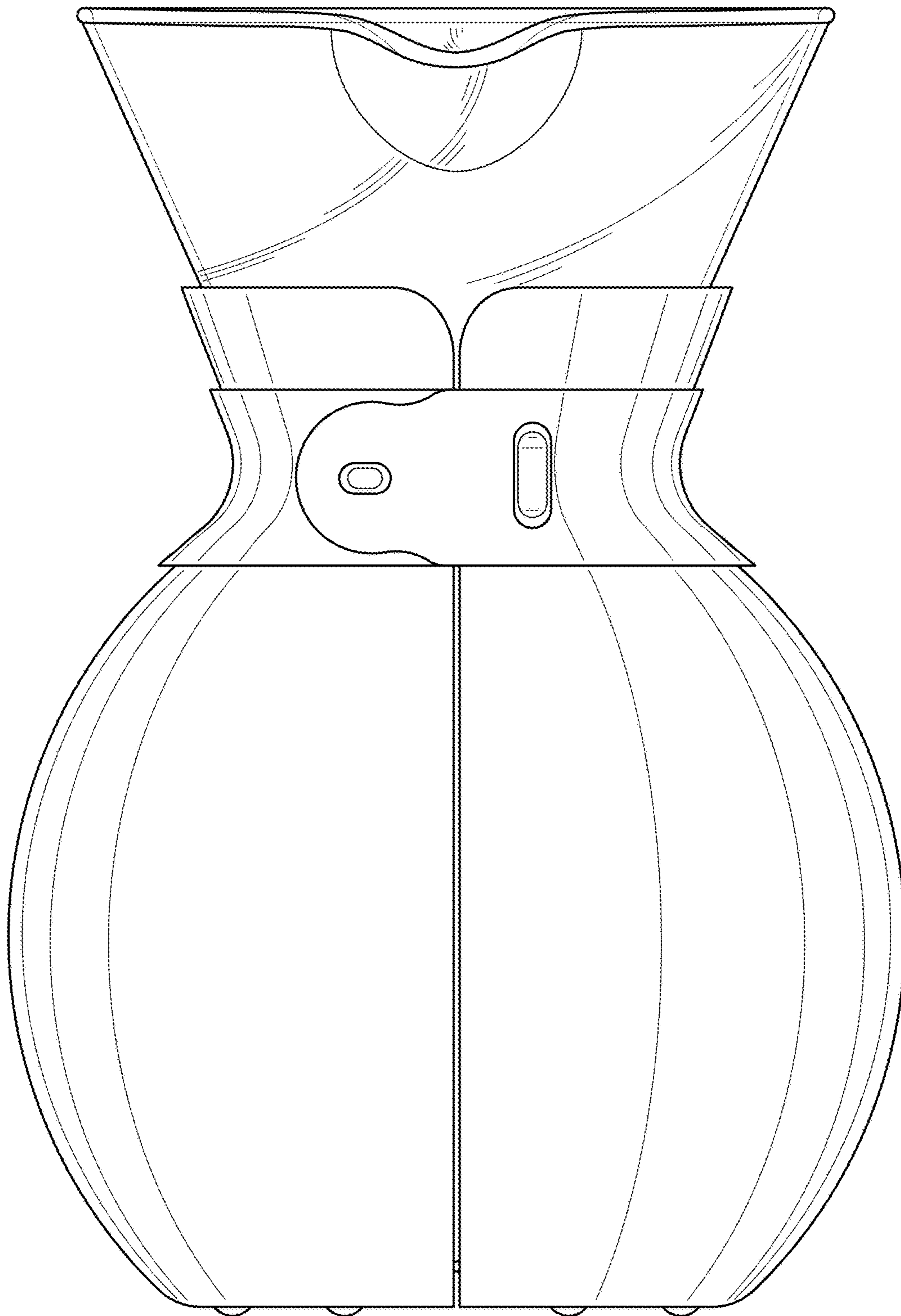

FIG. 2

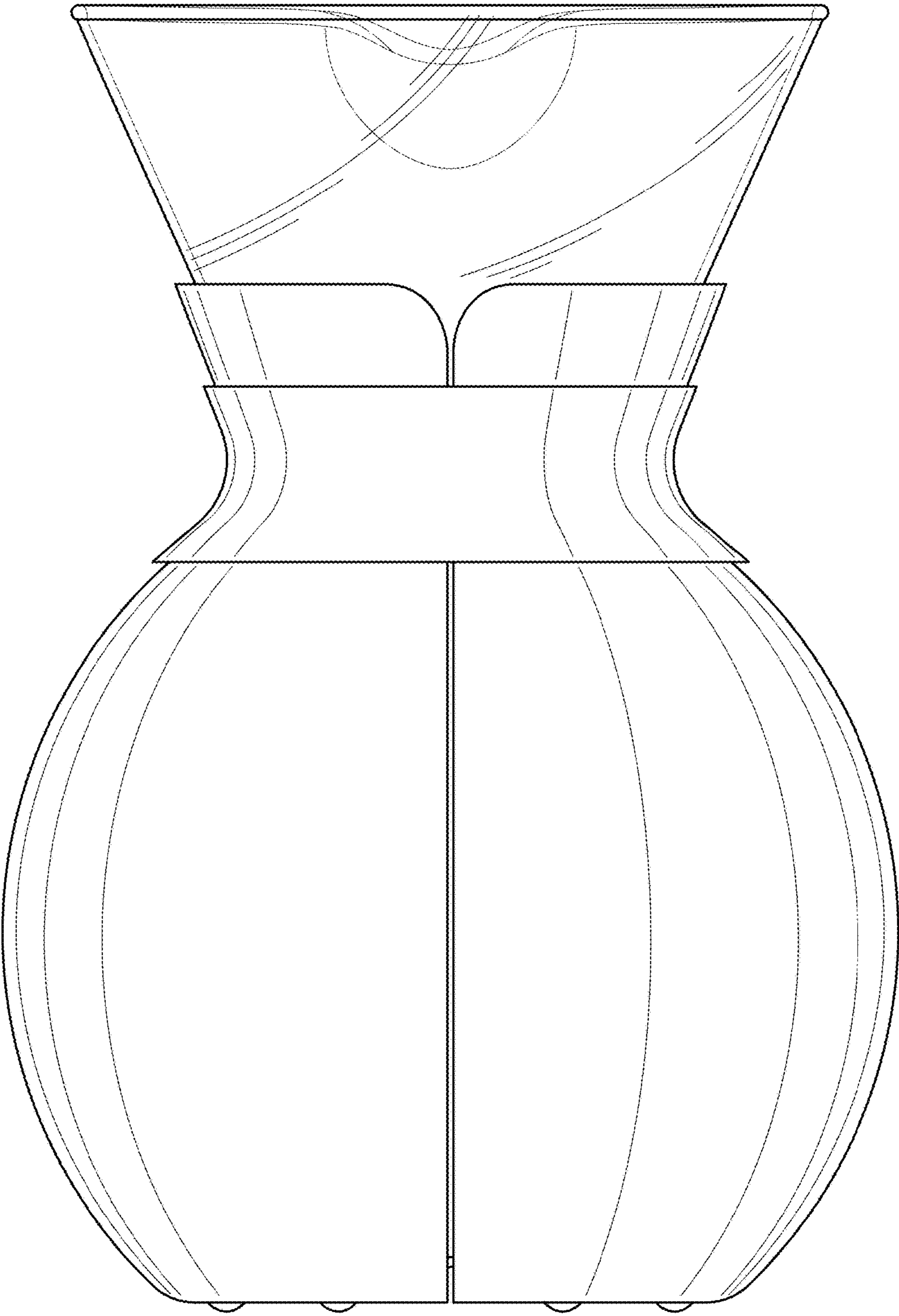

FIG. 3

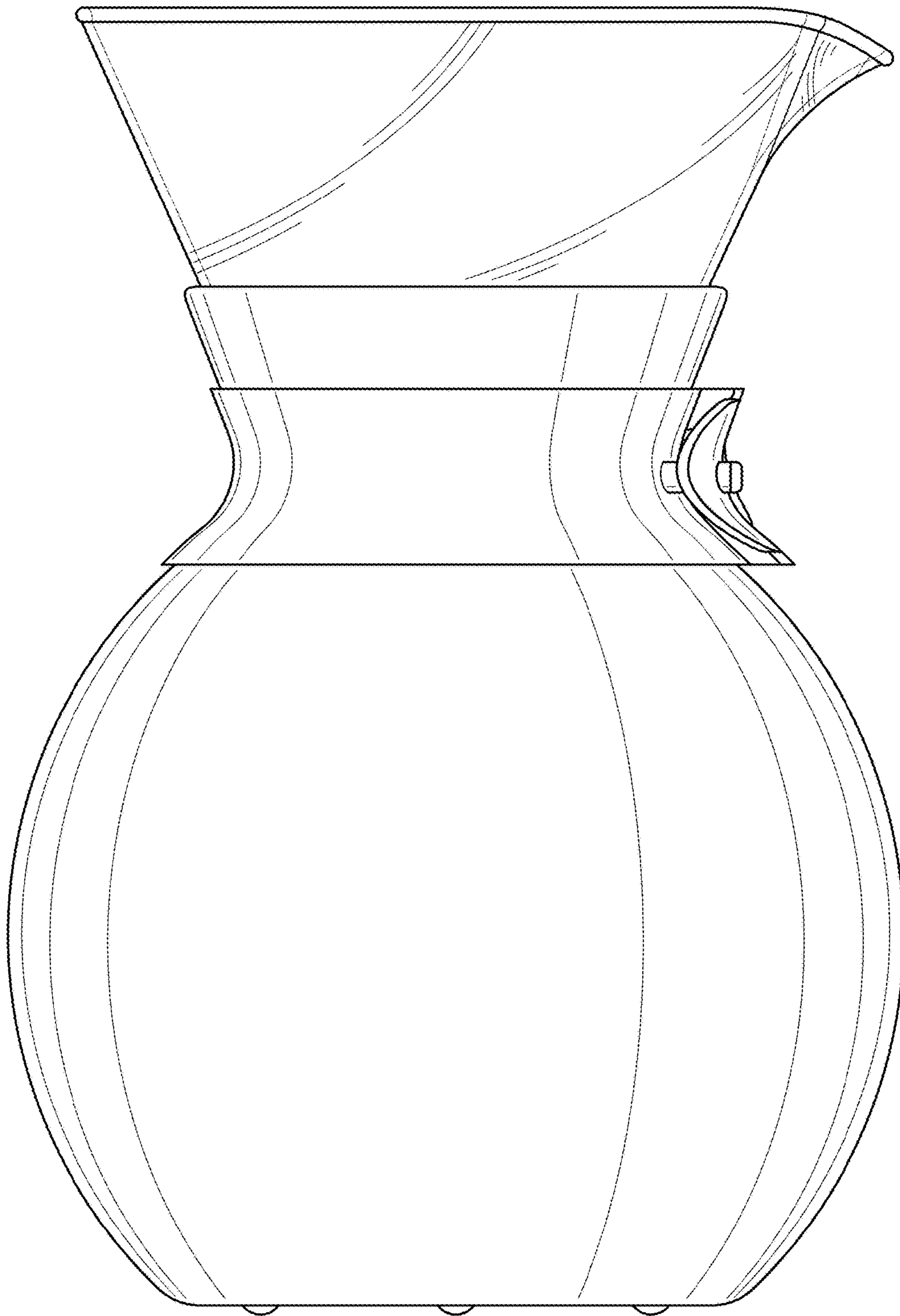

FIG. 4

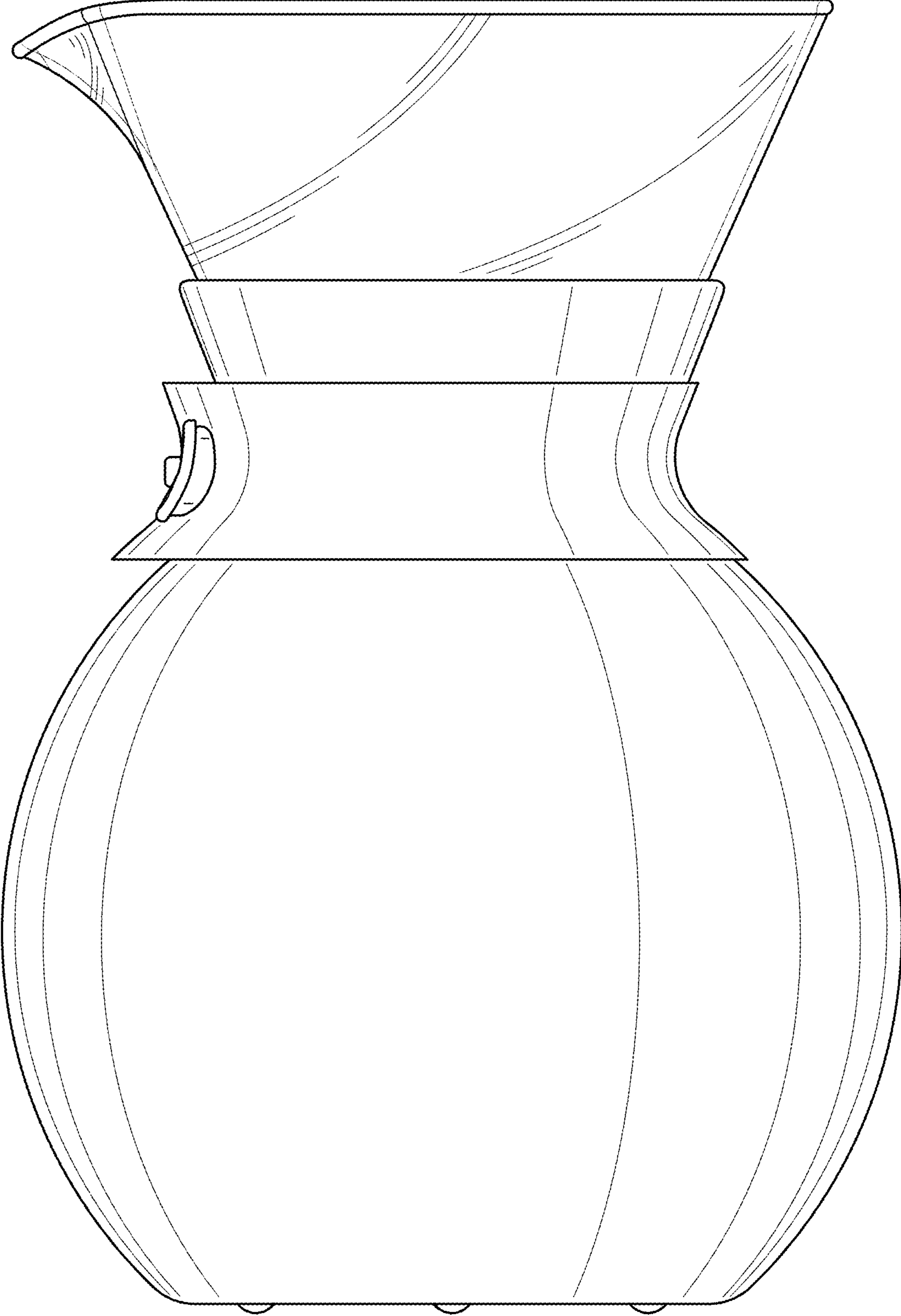

FIG. 5

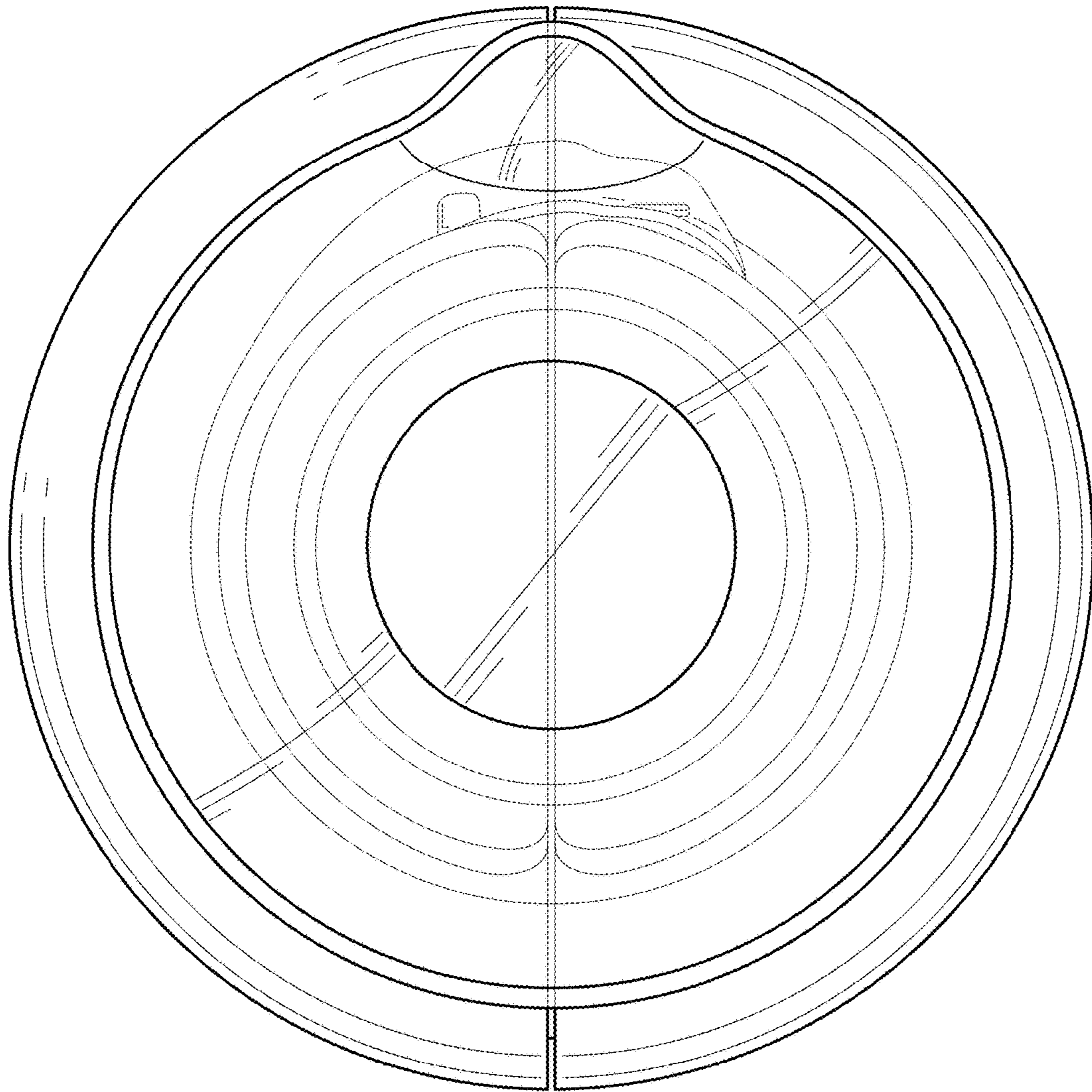

FIG. 6

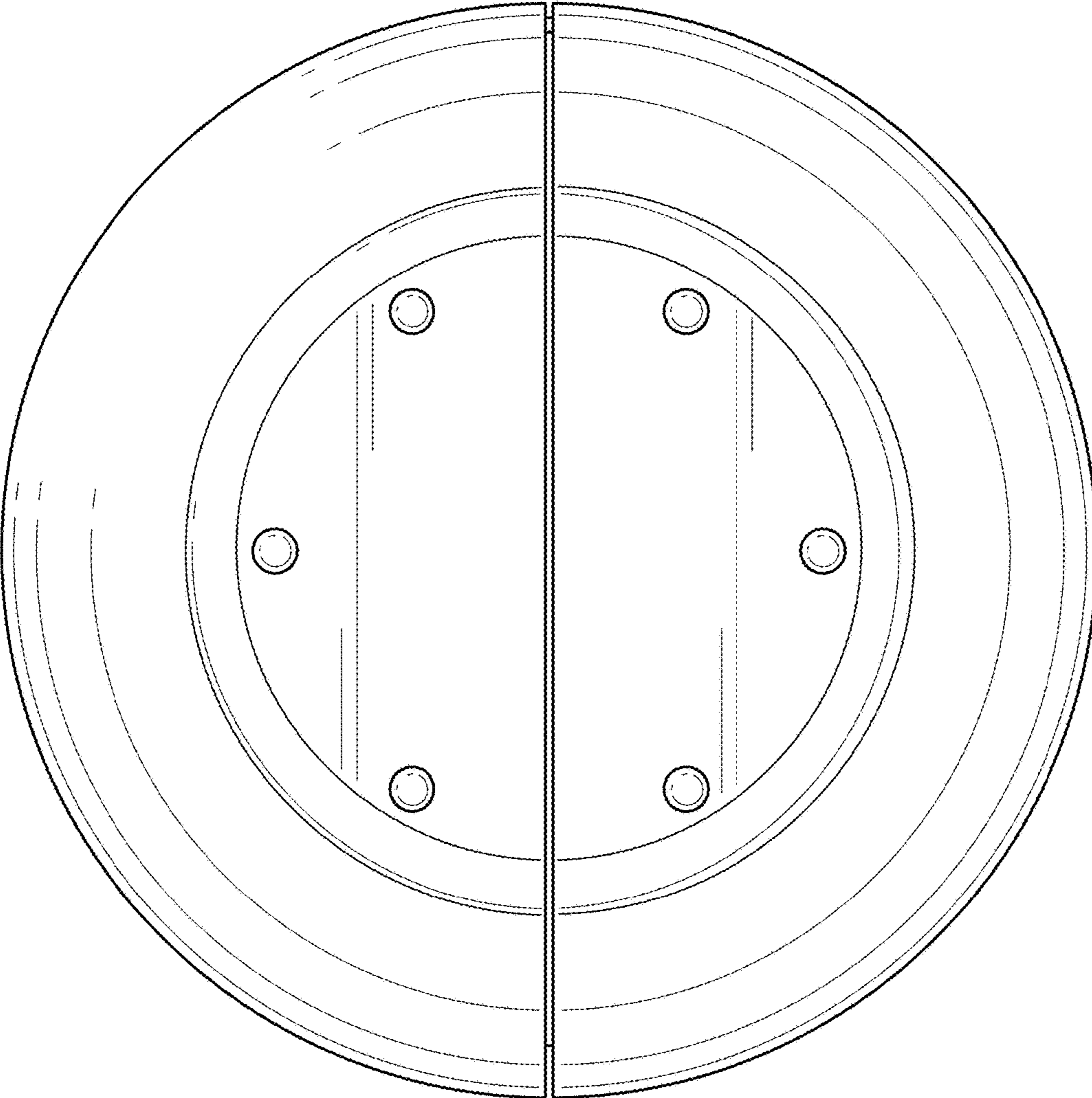

FIG. 7