



US00D830584S

(12) **United States Design Patent**
Comitale et al.

(10) **Patent No.:** **US D830,584 S**
(45) **Date of Patent:** **** Oct. 9, 2018**

(54) **FLOORING MEMBRANE**

FOREIGN PATENT DOCUMENTS

(71) Applicants: **Joe Comitale**, Mississauga (CA); **Svein Julton**, Tinn Austbygde (NO)

EM 003109875-0001 * 7/2016
EM 003109875-0002 * 7/2016

(72) Inventors: **Joe Comitale**, Mississauga (CA); **Svein Julton**, Tinn Austbygde (NO)

OTHER PUBLICATIONS

(**) Term: **15 Years**

Loxcreen Prova—The ultimate waterproofing system (on-line), dated Apr. 21, 2016. Retrieved from Internet Mar. 31, 2017, URL: <https://web.archive.org/web/20160421055555/http://www.loxcreenflooring.com/Catalogs.aspx> (2 pages).*

(21) Appl. No.: **29/563,441**

(Continued)

(22) Filed: **May 4, 2016**

(30) **Foreign Application Priority Data**

Primary Examiner — Vy Koenig

Assistant Examiner — Kimberly Barnes

Nov. 4, 2015 (CA) 165227

(74) *Attorney, Agent, or Firm* — Sean O'Connell, PLLC

(51) **LOC (11) Cl.** **25-01**

(52) **U.S. Cl.**

USPC **D25/138**; D25/158

(58) **Field of Classification Search**

USPC D25/138–163, 199, 106, 107, 109, 120

CPC ... H05B 3/00; H05B 3/06; H05B 3/34; H05B

3/146; H05B 2203/013; H05B 2203/026;

H05B 2203/032; F24D 3/12; F24D 3/14;

F24D 3/142; F24D 3/146; F24D 13/02;

E04F 15/02; E04F 15/024; E04F 15/18;

H02G 9/00; B32B 3/30

See application file for complete search history.

(56) **References Cited**

U.S. PATENT DOCUMENTS

731,158 A * 6/1903 Blackmore E04C 1/42
428/167
D100,215 S * 6/1936 Klipfel 404/19
2,043,987 A * 6/1936 Brown E04B 1/86
428/132
2,278,554 A * 4/1942 Morton B61D 23/00
105/457
2,280,631 A * 4/1942 Coffey A01B 15/02
181/293
2,421,171 A * 5/1947 Trautvetter B61D 23/00
29/896.6

(Continued)

(57) **CLAIM**

The ornamental design for a flooring membrane, as shown and described.

DESCRIPTION

FIG. 1 is a front left perspective view of a flooring membrane incorporating the design.

FIG. 2 is an enlarged view of encircled area 2 of FIG. 1.

FIG. 3 is a top plan view of the flooring membrane of FIG. 1.

FIG. 4 is a side elevation view of the flooring membrane of FIG. 1.

FIG. 5 is an enlarged cross-sectional view along 5-5 of FIG. 3.

FIG. 6 is an enlarged view of encircled area 6 of FIG. 5.

FIG. 7 is an enlarged cross-sectional view along 7-7 of FIG. 3; and,

FIG. 8 is an enlarged view of encircled area 8 of FIG. 7.

The broken lines in FIGS. 1 and 3 represent the bounds of the claimed design and form no part of the claimed design.

The broken lines in FIGS. 1 and 3 represent the bounds of the claimed design and form no part of the claimed design.

The broken lines in FIGS. 1 and 3 represent the bounds of the claimed design and form no part of the claimed design.

The broken lines in FIGS. 1 and 3 represent the bounds of the claimed design and form no part of the claimed design.

The broken lines in FIGS. 1 and 3 represent the bounds of the claimed design and form no part of the claimed design.

The broken lines in FIGS. 1 and 3 represent the bounds of the claimed design and form no part of the claimed design.

1 Claim, 5 Drawing Sheets

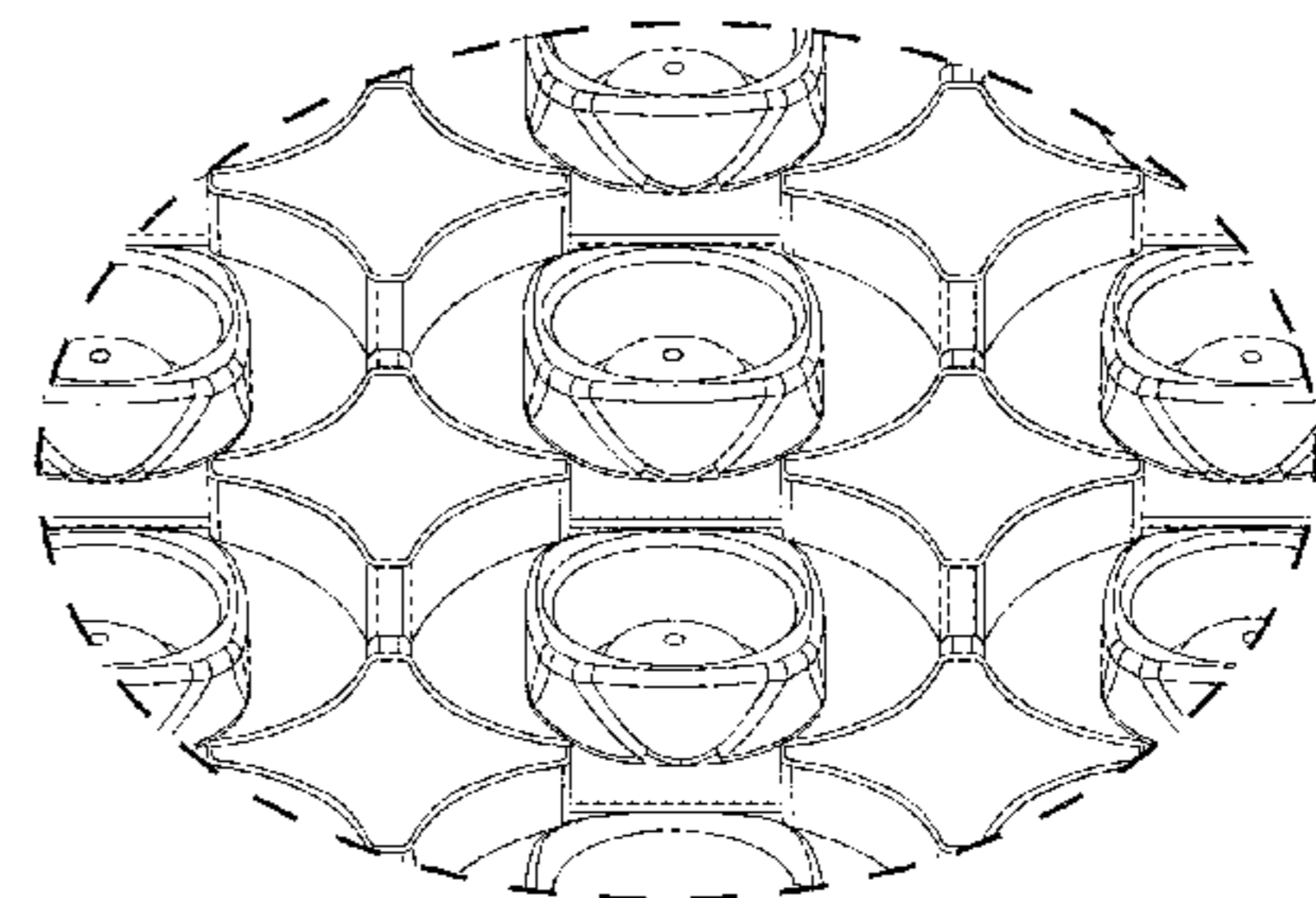
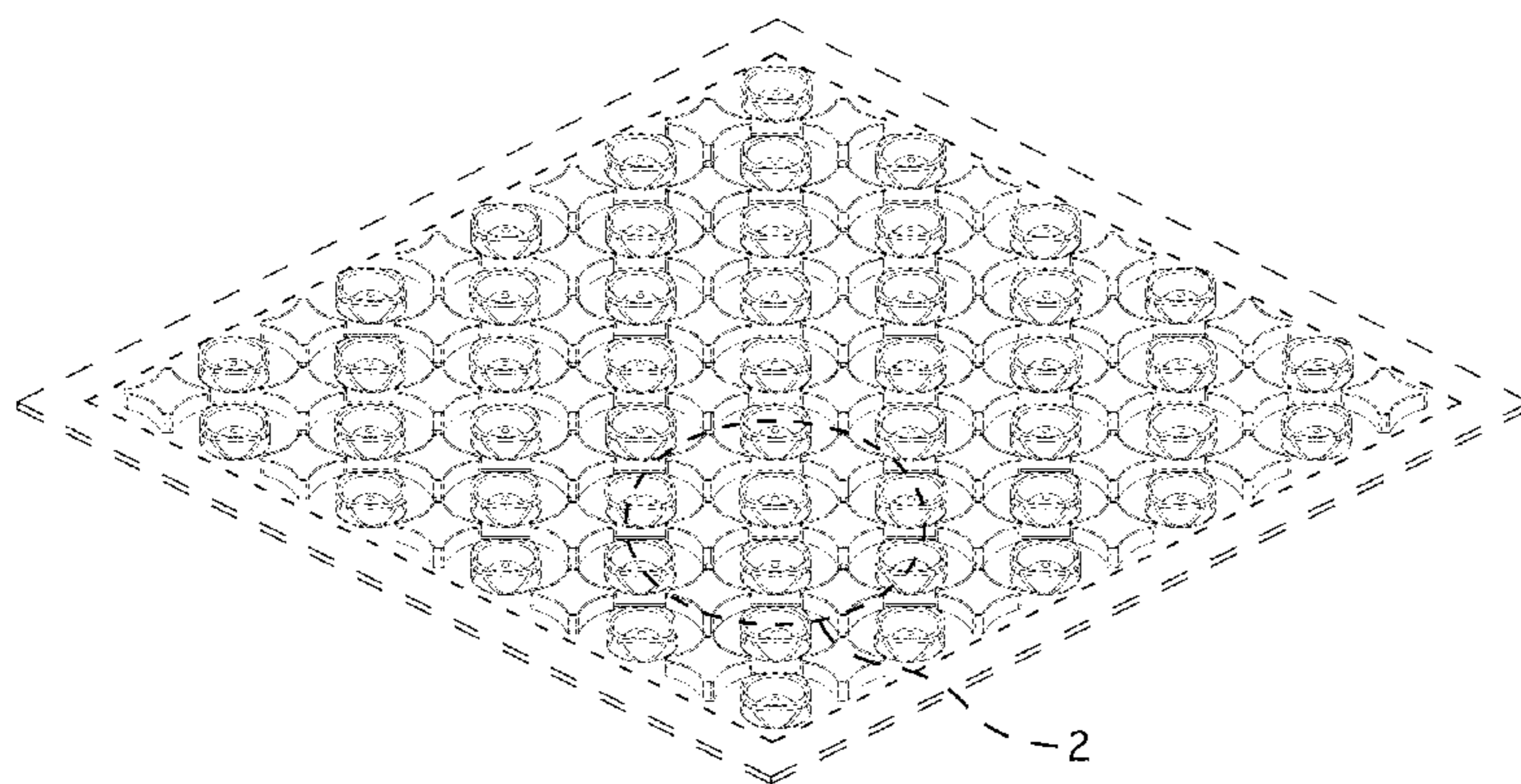

(56)

References Cited

U.S. PATENT DOCUMENTS

3,339,325 A * 9/1967 Knapp E04F 13/0885
52/309.4
D230,268 S * 2/1974 Shuey D25/158
4,189,888 A * 2/1980 Blitzer, Jr. E04B 9/04
52/311.1
4,222,695 A * 9/1980 Sarides B60N 3/046
410/68
D272,957 S * 3/1984 Bergsland D25/155
D281,752 S * 12/1985 Dickens D6/582
5,082,712 A * 1/1992 Starp E04F 15/02411
428/174
6,451,400 B1 * 9/2002 Brock A47L 23/24
15/161
6,539,681 B1 * 4/2003 Siegmund E04F 15/02429
404/36
6,691,472 B2 * 2/2004 Hubert E02D 31/02
405/107
D493,897 S * 8/2004 Campacci D25/158
D541,396 S * 4/2007 Fawcett D23/314
D587,358 S * 2/2009 Stephan D23/314
7,651,757 B2 * 1/2010 Jones E04F 15/18
428/158
7,716,892 B2 * 5/2010 Kim E04B 9/0442
52/311.1
D668,117 S * 10/2012 Shimizu D14/441
D706,459 S * 6/2014 Schluter D25/138

D721,191 S * 1/2015 Amend D25/157
8,931,592 B2 * 1/2015 Savian B64C 1/066
181/210
8,950,141 B2 * 2/2015 Schluter E04F 15/182
52/385
9,174,722 B2 * 11/2015 Savian B64C 1/066
9,188,348 B2 * 11/2015 Larson F24D 13/024
D771,837 S * 11/2016 Astacio D25/117
D773,697 S * 12/2016 Amend D25/157
2002/0119275 A1 * 8/2002 Williamson A47L 23/24
428/44
2016/0130803 A1 * 5/2016 Comitale B32B 3/30
428/166
2016/0160502 A1 * 6/2016 Brousseau E04C 2/205
52/309.4
2016/0192443 A1 * 6/2016 Schluter F24C 15/168
174/97
2016/0273232 A1 * 9/2016 Bordin E04F 15/185
2017/0073980 A1 * 3/2017 Szonok E04F 21/00

OTHER PUBLICATIONS

Polypipe Solid Underfloor Heating Panel (on-line), dated Aug. 24, 2014. Retrieved from Internet Mar. 24, 2017, URL: https://web.archive.org/web/20140824234734/https://www.colglo.co.uk/productlist.php?category=Polypipe_UFCH_Screed_Floor_Panel (1 page).*

* cited by examiner

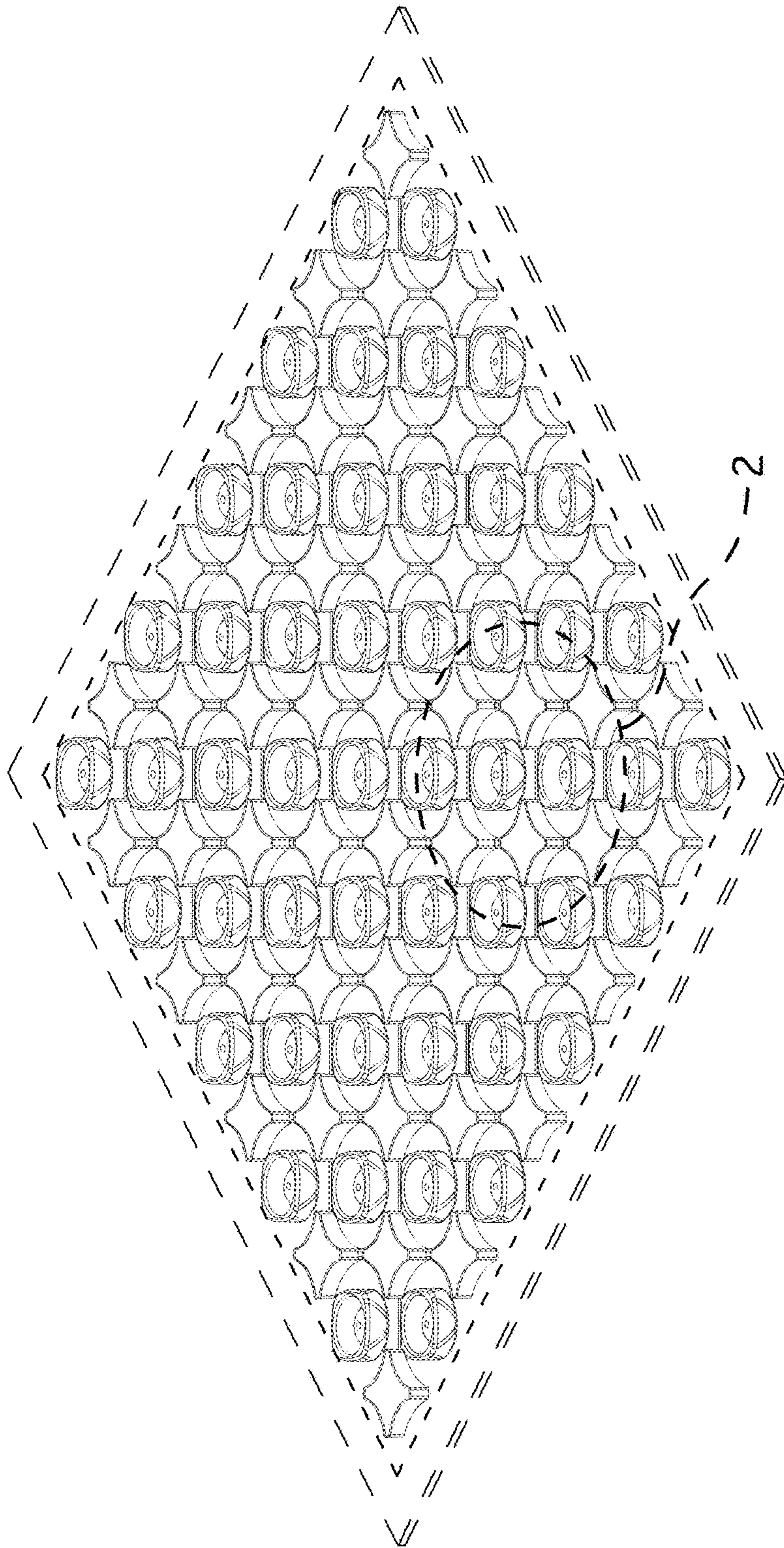

FIG. 1

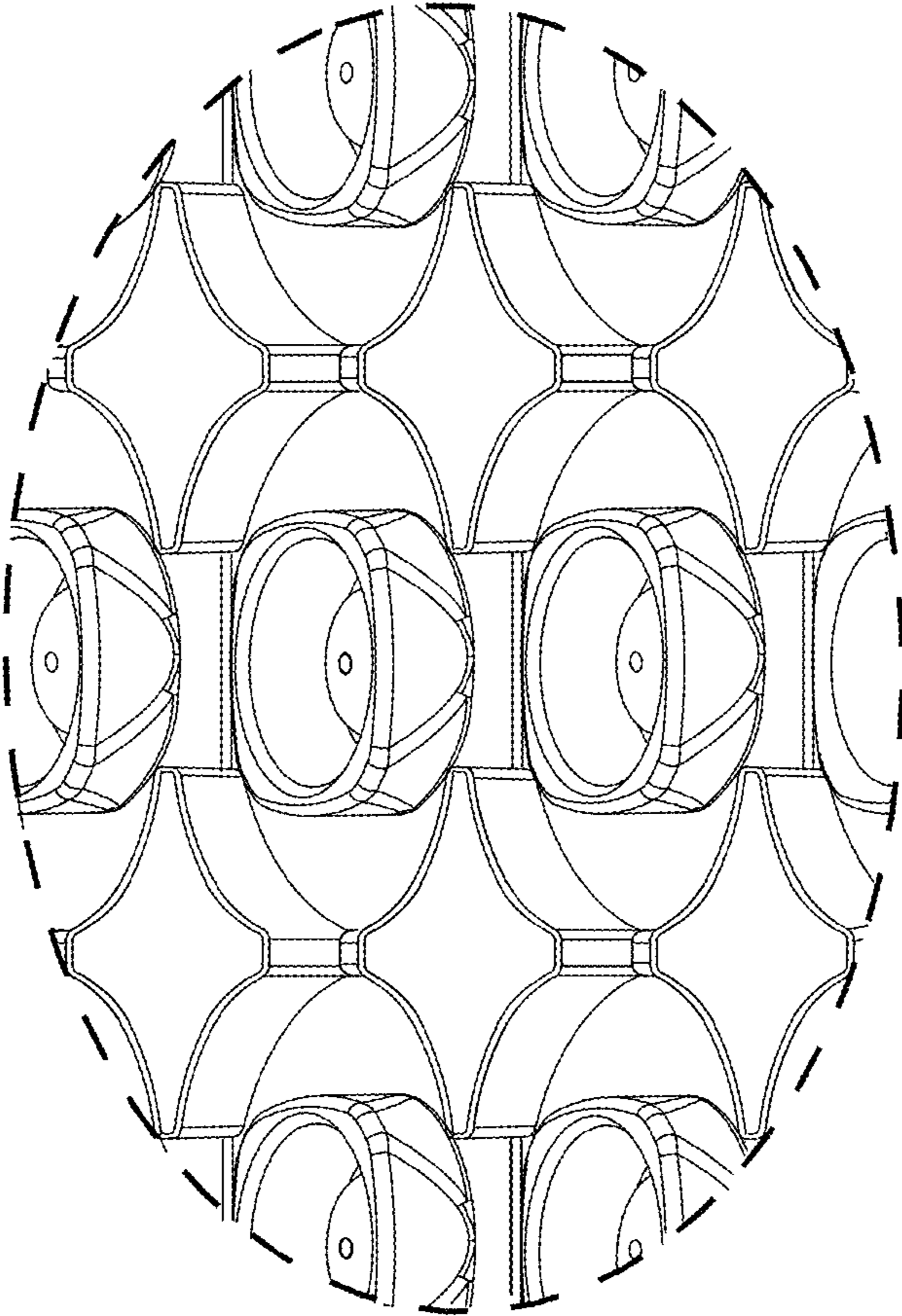

FIG.2

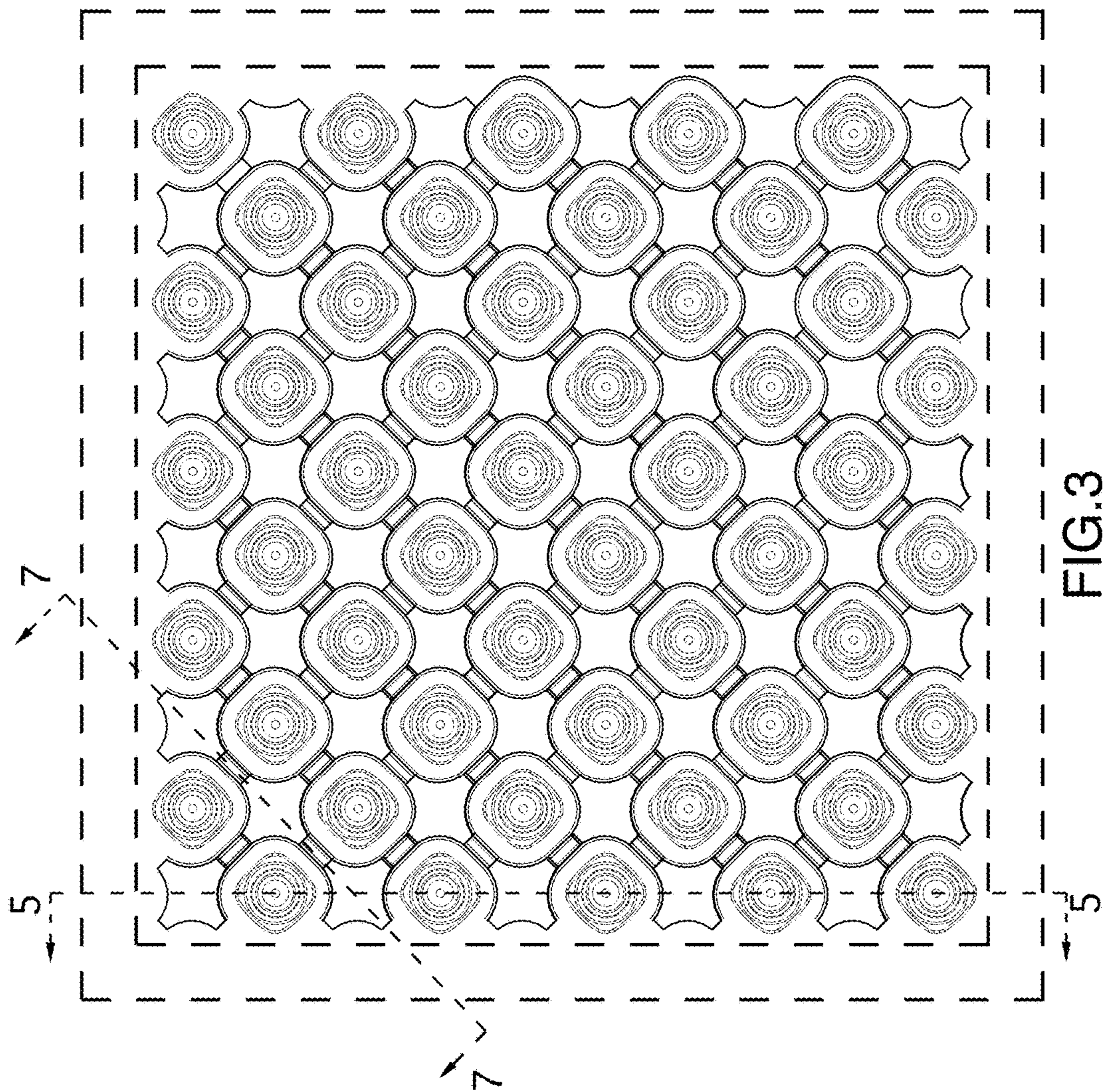
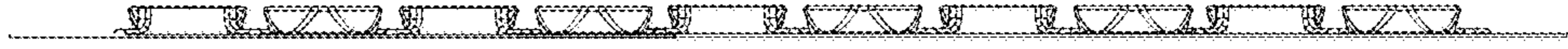

FIG. 4



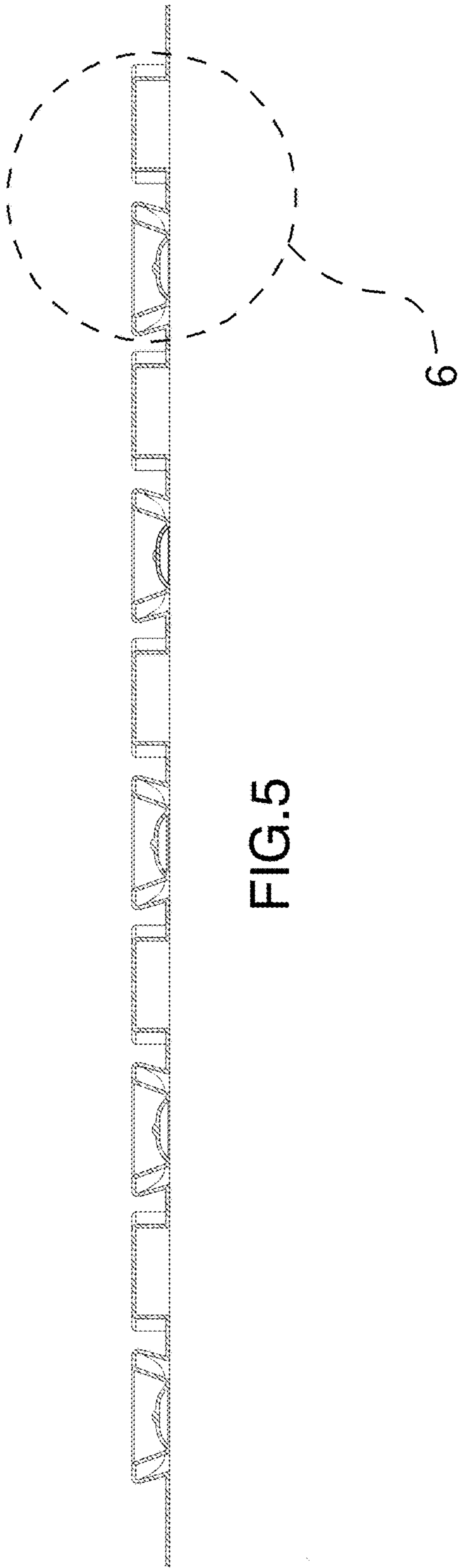

FIG. 5

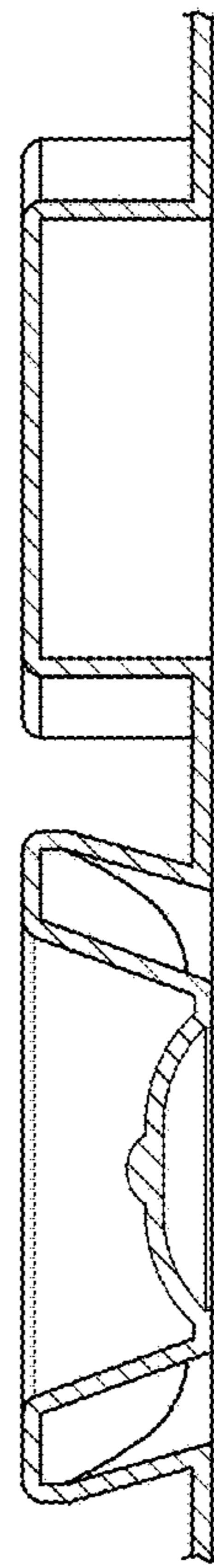

FIG. 6

